



ASCLASS

ASCLASS CERRAHİ ALETLER İMALAT SAN. VE TİC. LTD.ŞTİ

📍 Çatalarmut Mahallesi Sezgin Sokak No:7 Kat:1/2/3 İlkadım/SAMSUN

📱 asclasscerrahialetler.ve.medya 🌐 Asclass cerrahi aletler 🌐 www.asclassgrup.com 📧 info@asclassgrup.com - asclassmedya@gmail.com

ÜRÜN GRUPLARIMIZ

- » Genel Cerrahi
- » Beyin Cerrahi
- » Ortopedi Cerrahi
- » Göz Cerrahi
- » Kulak Burun Boğaz
- » Jinekoloji
- » Üroloji
- » Kalp Damar
- » Üniversal Ekartör Setleri
- » Laparoskopik Ekartör Setleri
- » Laparoskopik El Aletleri
- » Steril Konteynir Sistem

60

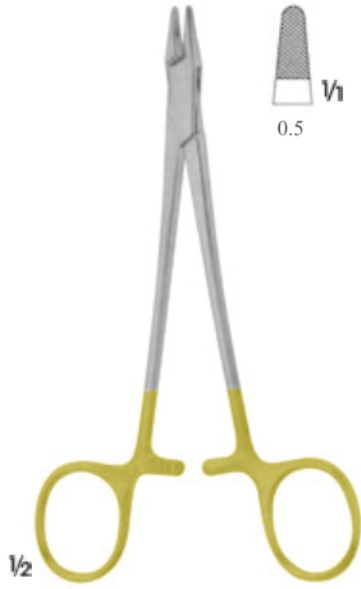

1/2

60-100
Tel bükücü/Wire twister
Bağlama pens/Ligature forceps
15 cm

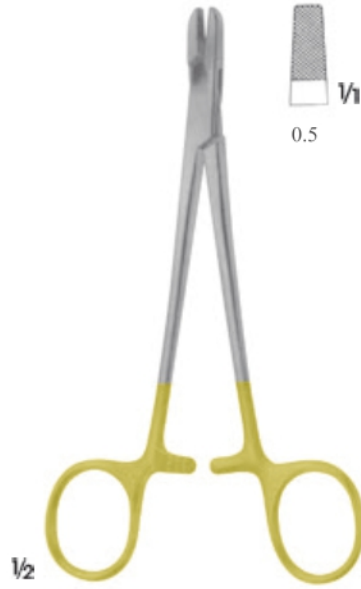

1/2

60-101
Tel bükücü/Wire twister
Bağlama pens/Ligature forceps
15 cm

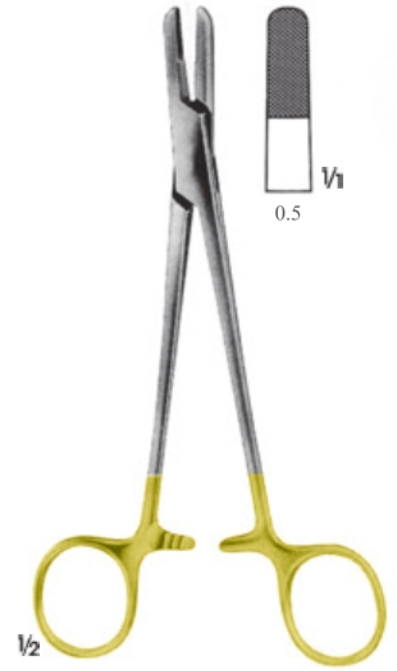

1/2

60-102
Sternum dikişi için
For sternum suture
17.5 cm



1/2

BERRY
60-103
Tel bükücü/Wire twister
Bağlama pens/Ligature forceps
18.5 cm



1/2

BAUMGARTNER
60-104
Tel bükücü/Wire twister
Bağlama pens/Ligature forceps
20 cm



1/2

60-105
17 cm

Kaymayı engellemek için
yanal çeneleri olan serklaj teli
tutma Pensi
Holding forceps for cerclage wire,
with lateral jaws to avoid
wire slipping off





1/3

60-106
Alçı ayırıcı
Plaster shear
23 cm



1/3

HENNIG
60-107
Alçı ayırıcı
Plaster shear
27 cm



WOLFF
60-108 18 cm
60-109 24 cm
Alçı kesiciler
Plaster breakers



1/3

60-110
Alçı ayırıcı
Plaster shear
29 cm



Sökülebilir çeneli
With removable jaws



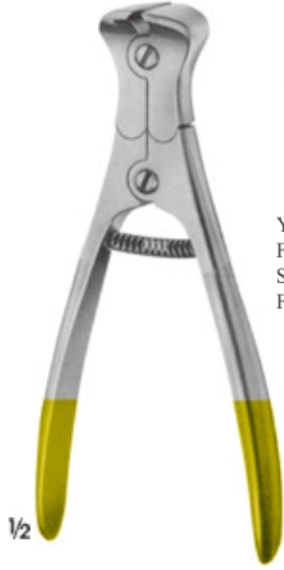

Yumuşak tel için Ø 2.0 mm
For soft wire Ø 2.0 mm
Sert tel için Ø 1.5 mm
For hard wire Ø 1.5 mm

1/2

60-111
14.5 cm

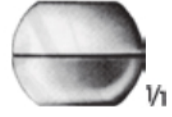

Yumuşak tel için Ø 1.5 mm
For soft wire Ø 1.5 mm
Sert tel için Ø 1.0 mm
For hard wire Ø 1.0 mm

1/2

60-112
14.5 cm



Yumuşak tel için Ø 3.5 mm
For soft wire Ø 3.5 mm
Sert tel için Ø 2.5 mm
For hard wire Ø 2.5 mm

1/2

60-113
16.5 cm



Yumuşak tel için Ø 3.0 mm
For soft wire Ø 3.0 mm
Sert tel için Ø 2.0 mm
For hard wire Ø 2.0 mm

1/2

60-114
22 cm



Özel sertleştirilmiş kesici ağız
Specially hardened cutting edges

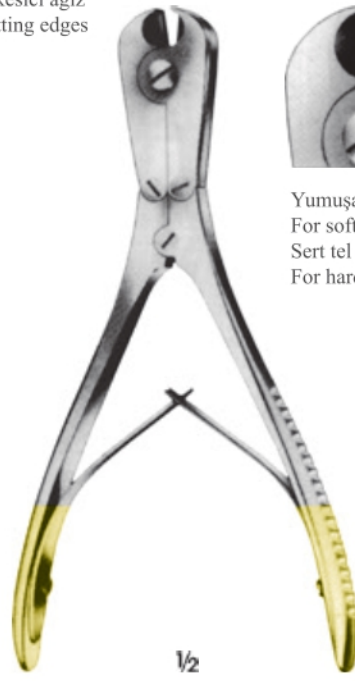

Yumuşak tel için Ø 2.0 mm
For soft wire Ø 2.0 mm
Sert tel için Ø 1.5 mm
For hard wire Ø 1.5 mm

REILL
60-115
Kemiğe yakın olan
telleri kesme
For cutting off wires close
to the bone
17.5 cm



Yumuşak tel için Ø 2.0 mm
For soft wire Ø 2.0 mm
Sert tel için Ø 1.5 mm
For hard wire Ø 1.5 mm

60-116
Tel kesiciler, ön ve yan kesme
hareketli
Wire cutters, front-and lateral
cutting action
18 cm

Özel sertleştirilmiş kesici ağız
Specially hardened cutting edges



Yumuşak tel için Ø 3.0 mm
For soft wire Ø 3.0 mm
Sert tel için Ø 2.2 mm
For hard wire Ø 2.2 mm

HARVEY
60-117
Tel kesme pensi
Wire cutting pliers
23.5 cm

Sert metal kesici ağız
Tungsten carbide cutting edges



Yumuşak tel için Ø 2.5 mm
For soft wire Ø 2.5 mm
Sert tel için Ø 2.0 mm
For hard wire Ø 2.0 mm

60-118
Tel kesme pensi
Wire cutting pliers
24 cm



60-119
16 cm

Yumuşak tel için Ø 1.5 mm
For soft wire Ø 1.5 mm
Sert tel için Ø 1.2 mm
For hard wire Ø 1.2 mm



60-120
15 cm

Yumuşak tel için Ø 1.5 mm
For soft wire Ø 1.5 mm
Sert tel için Ø 1.0 mm
For hard wire Ø 1.0 mm

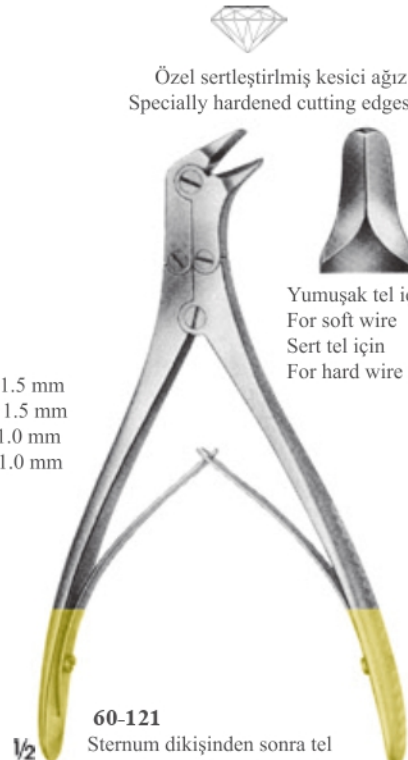

60-121

Sternum dikişinden sonra tel çıkartılması için açılı narın yapı
Angled slender pattern for wire removal after sternum suture
17 cm

Özel sertleştirilmiş kesici ağız
Specially hardened cutting edges

Yumuşak tel için Ø 0.9 mm
For soft wire Ø 0.9 mm
Sert tel için -
For hard wire -

Özel sertleştirilmiş kesici ağız
Specially hardened cutting edges



HARVEY
60-122
Tel kesme pens
Wire cutting pliers
23 cm

Yumuşak tel için Ø 3.0 mm
For soft wire Ø 3.0 mm
Sert tel için Ø 2.2 mm
For hard wire Ø 2.2 mm



60-123
Yanal kesme
Lateral cutting
23.5 cm

Yumuşak tel için Ø 3.0 mm
For soft wire Ø 3.0 mm
Sert tel için Ø 2.2 mm
For hard wire Ø 2.2 mm



60-124

Ø 6 mm kadar tel, vida, çivi vs. kesmek için
For cutting off wires, screws, pins, etc. up to Ø 6 mm
47 cm



60-125

Ø 3 mm kadar tel, vida, çivi vs. kesmek için
For cutting off wires, screws, pins, etc. up to Ø 3 mm
32 cm





MARBURG MODELL
60-126
Tel tutma pens,
Düz burunlu, tırtıllı ağız
Wire holding forceps,
Flat nosed, with serrated jaws
14 cm



GOSLEE
Tel bükücü, düz burunlu
Wire twister, flat nosed
14 cm



Düz ağız
Smooth jaw
60-127

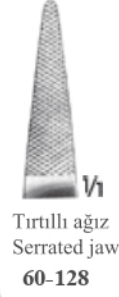

Tırtıllı ağız
Serrated jaw
60-128



Tel bükücü, düz burunlu
Wire twister, flat nosed
17 cm



60-129
Tırtıllı ağız
With serrated jaws



Boylamasına ve
çapraz kanallı
With longitudinal
and transversal
grooves
60-130



60-131
19.5 cm



60-132
Tel tutma pens, düz burunlu
Wire holding forceps, flat nosed
19 cm



Tel çıkarma pensi
Extraction pliers for boring
wires



60-133
13 cm



60-134
18 cm



60-135
Yuvarlak pens
Round pliers
18 cm



60-137
Tel çıkartıcı pens
Extraction pliers
for wires
18 cm



60-136
Tel çıkartıcı pens
Extraction pliers for
wires
14.5 cm

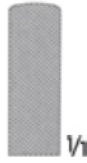

60-138
Tel çıkartıcı pens
Extraction pliers for
wires
18 cm



1/2

60-139
Ø 1.8 mm kadar teller için
bükme pens
Bending pliers for wires up to
1.8 mm diam.



1/2

60-140
Paralel düz tutucu
Flat-nosed pliers, parallel
18.5 cm



1/1



1/2

60-141
Mengene kavramalı, ayarlı pense
Vise grip pliers set
20 cm



1/1



Sert metal kesici ağız
Tungsten carbide cutting edges

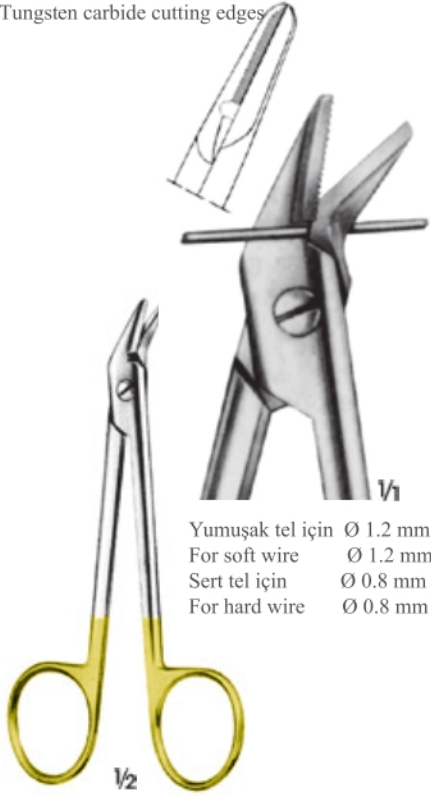

Yumuşak tel için Ø 1.2 mm
For soft wire Ø 1.2 mm
Sert tel için Ø 0.8 mm
For hard wire Ø 0.8 mm

60-142
Tek ağız tırtıllı
One jaw serrated
12 cm

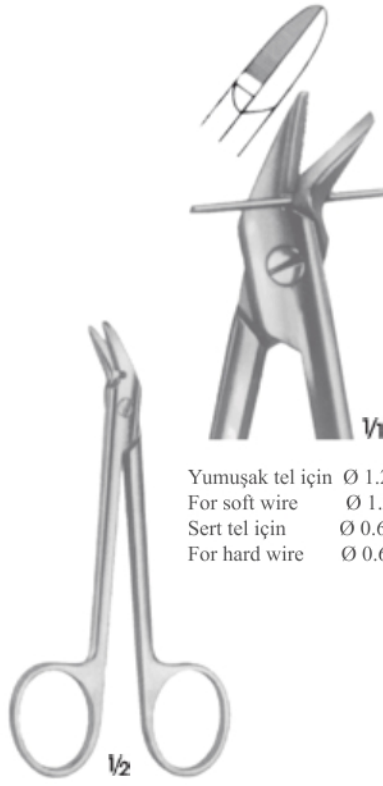

Yumuşak tel için Ø 1.2 mm
For soft wire Ø 1.2 mm
Sert tel için Ø 0.6 mm
For hard wire Ø 0.6 mm

60-143
Tek ağız tırtıllı
One jaw serrated
12 cm

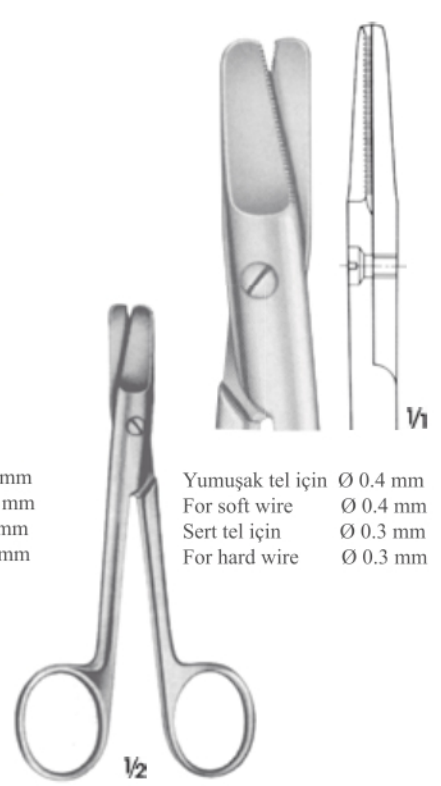

Yumuşak tel için Ø 0.4 mm
For soft wire Ø 0.4 mm
Sert tel için Ø 0.3 mm
For hard wire Ø 0.3 mm

HARVEY
60-144
Çift ağız tırtıllı
Both jaws serrated
12.5 cm



Özel sertleştirilmiş kesici ağız
Specially hardened cutting edges

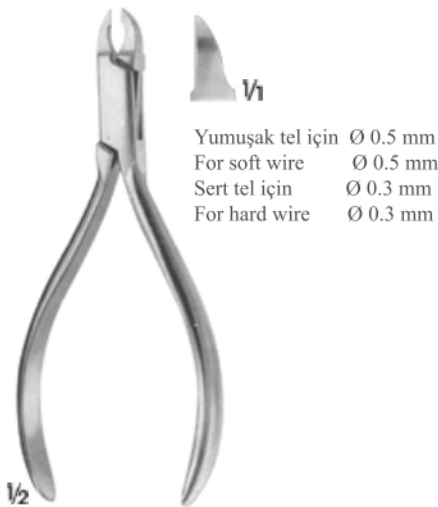

Yumuşak tel için Ø 0.5 mm
For soft wire Ø 0.5 mm
Sert tel için Ø 0.3 mm
For hard wire Ø 0.3 mm

ANGLE
60-145
13 cm

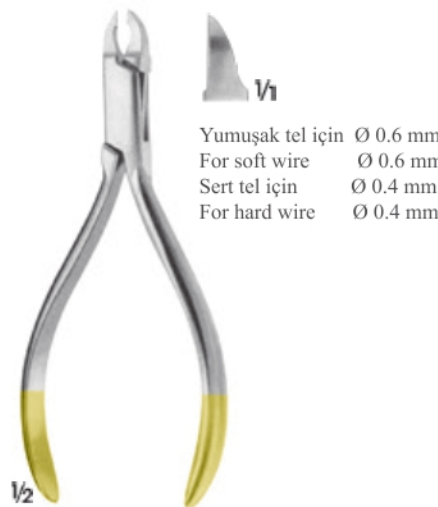

Yumuşak tel için Ø 0.6 mm
For soft wire Ø 0.6 mm
Sert tel için Ø 0.4 mm
For hard wire Ø 0.4 mm

60-146
13 cm

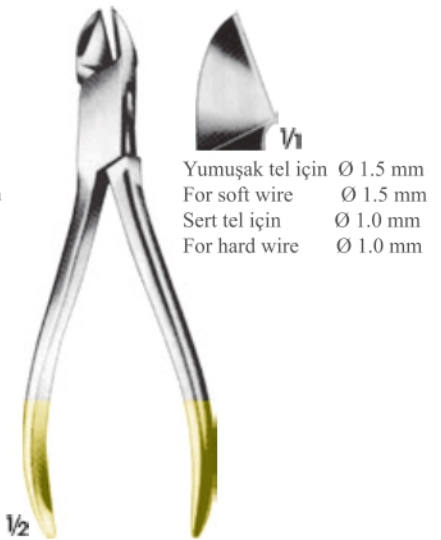

Yumuşak tel için Ø 1.5 mm
For soft wire Ø 1.5 mm
Sert tel için Ø 1.0 mm
For hard wire Ø 1.0 mm

60-147
Tel kesme pensisi
Wire cutting pliers
14 cm



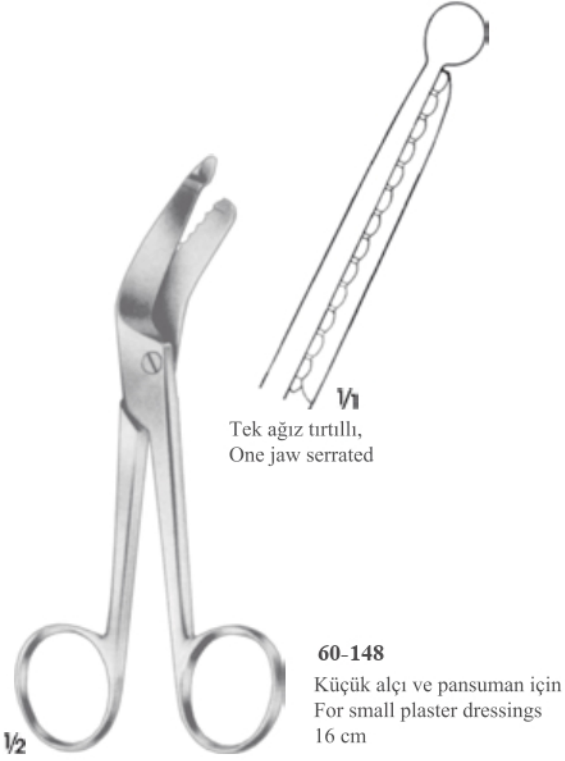



ESMARCH
60-153
Alçı bıçağı
Plaster knife
18 cm

1/2



ENGEL
60-154
Alçı testeresi
Plaster saw
15 cm

1/2



BRUNS
60-155
23.5 cm

1/2

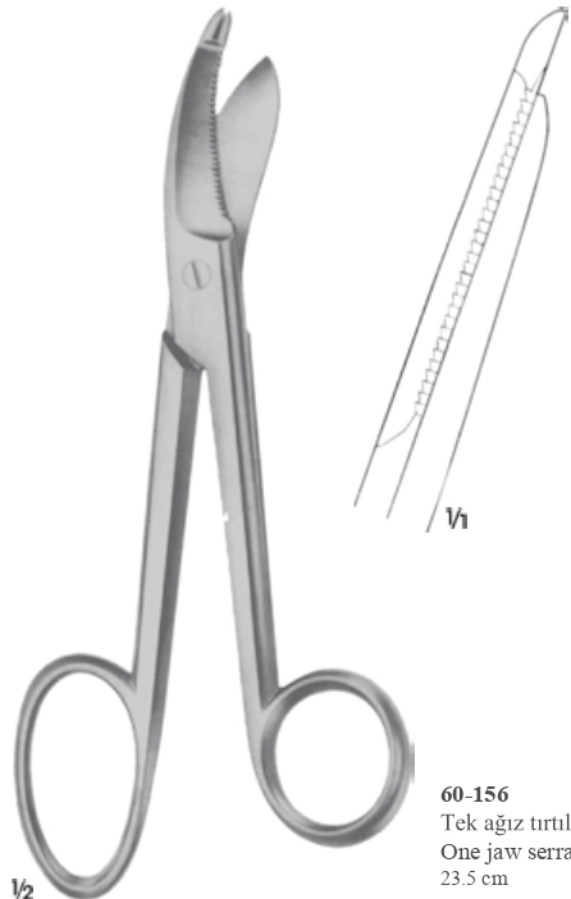

60-156
Tek ağız tırtıllı
One jaw serrated
23.5 cm

1/2



1/3

STILLE
60-157
23 cm



1/3

STILLE
60-158
26 cm



1/3

STILLE
60-159
36 cm



1/3

STILLE
60-160
37 cm



60-160 Ø 0.2 mm	60-163 Ø 0.5 mm	60-166 Ø 0.8 mm	60-169 Ø 1.2 mm
60-161 Ø 0.3 mm	60-164 Ø 0.6 mm	60-167 Ø 0.9 mm	60-170 Ø 1.5 mm
60-162 Ø 0.4 mm	60-165 Ø 0.7 mm	60-168 Ø 1.0 mm	

Yumuşak doku uyumlu tel 10 m
Wire, soft, tissue compatible, in coils of 10 m

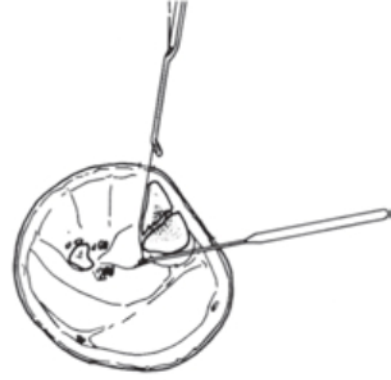

Implantlar için kullanılan malzemedan yapılmış hareketli uç. Bükülürken hareketli başlık sabit kalır bu sayede tel kalmaz.
Movable tip made of material used for implants. While twisting the movable head remains stable, therefore the wire will not slip off.

1/2

LOUTE
60-171

Tel gerici, geliştirilmiş model, hareketli uç ile 1.0 mm çapına kadar olan teller için
Wire tightener, improved pattern, with movable tip, for wires up to 1.0 mm diam
22 cm

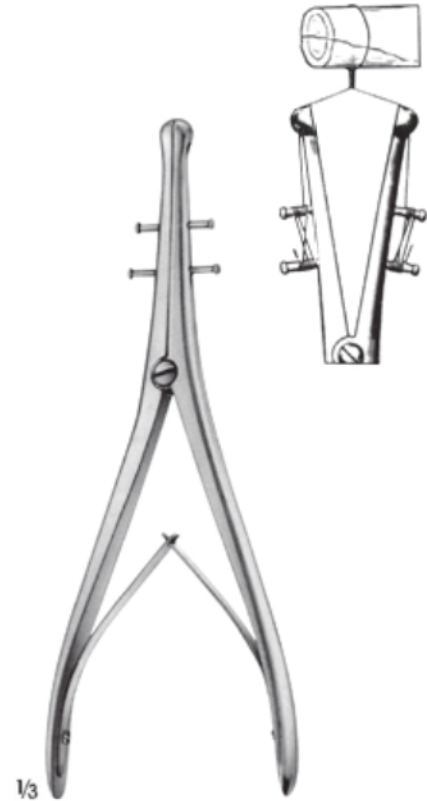

1/3

DEMEL
60-172

Gerdirek tel sıkma, büküm pensi
Wire tightening-and twisting forceps
27 cm





60-173
22.5 cm



60-174 - 60-175

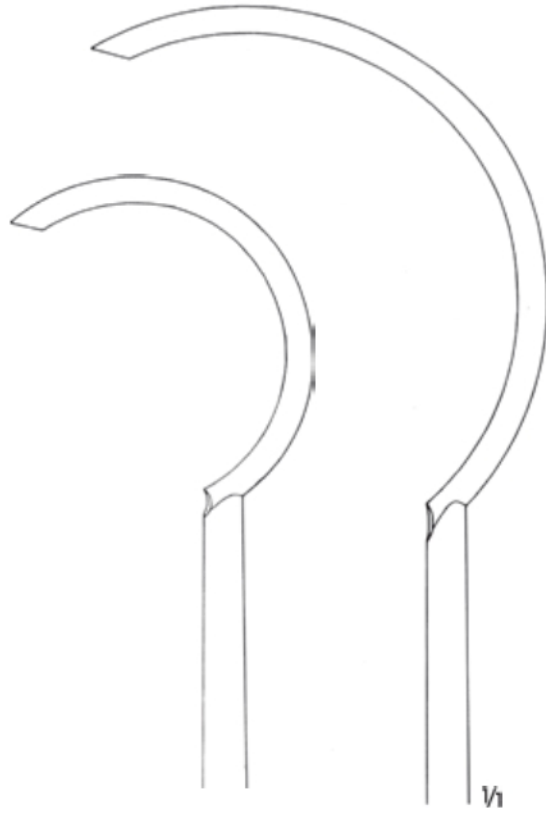

60-174
24 cm

60-175
27 cm



60-176
27.5 cm

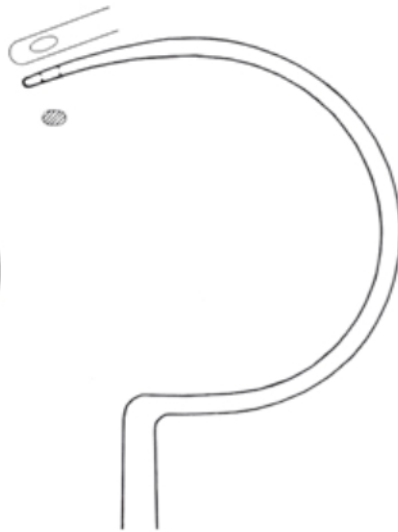

60-177
28.5 cm

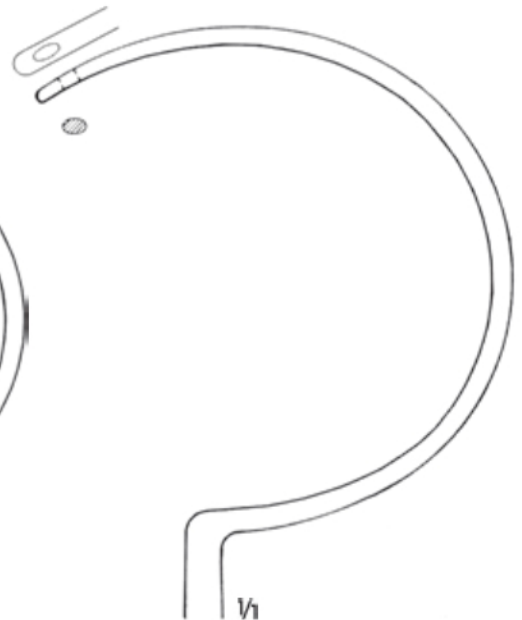

60-178
30.5 cm

DEMEL

Tel kılavuzları/Wire guides

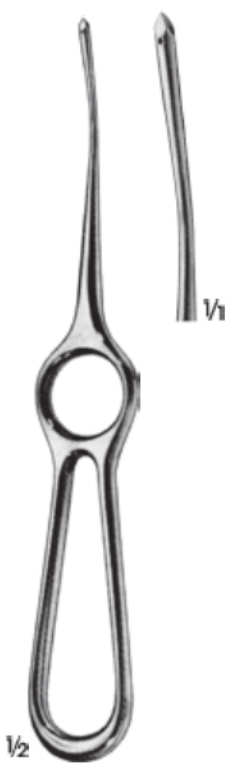

**OBWEGESER
60-179**
19.5 cm



**OBWEGESER
60-180**
23 cm

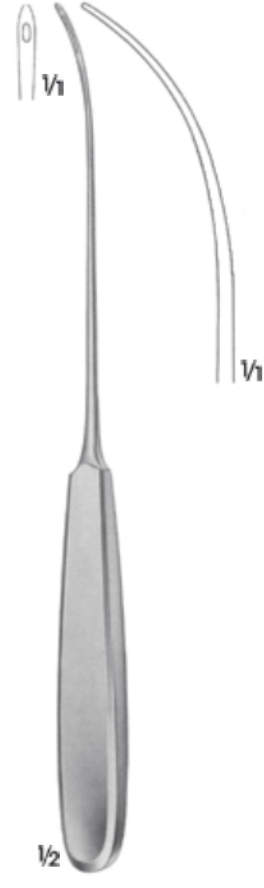

60-181
Bükülebilir/Malleable
23 cm

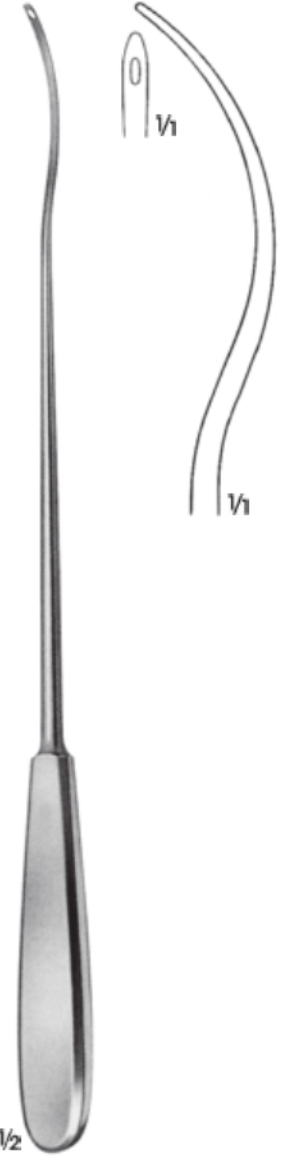

**BRUNNER
60-182**
30 cm



60-183
Delme başlığı
Drilling chuck
Ø 0.8-2 mm
15 cm



60-184
Delme başlığı Ø 4.5 mm
Drilling chuck Ø 4.5 mm
T30-092 anahtarı ile
With key T30-092
14 cm



60-185
Delme başlığı Ø 6.35 mm
Drilling chuck Ø 6.35 mm
T30-090 anahtarı ile
With key T30-090
16 cm



60-186
Anahtar/Key



60-187
Anahtar/Key

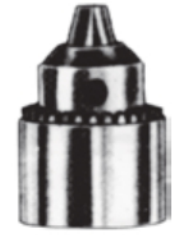

60-188 Anahtarı ile
With key

İç çap/İnside Ø 6.7 mm
Dış çap/Outside Ø 8.7 mm



1/1

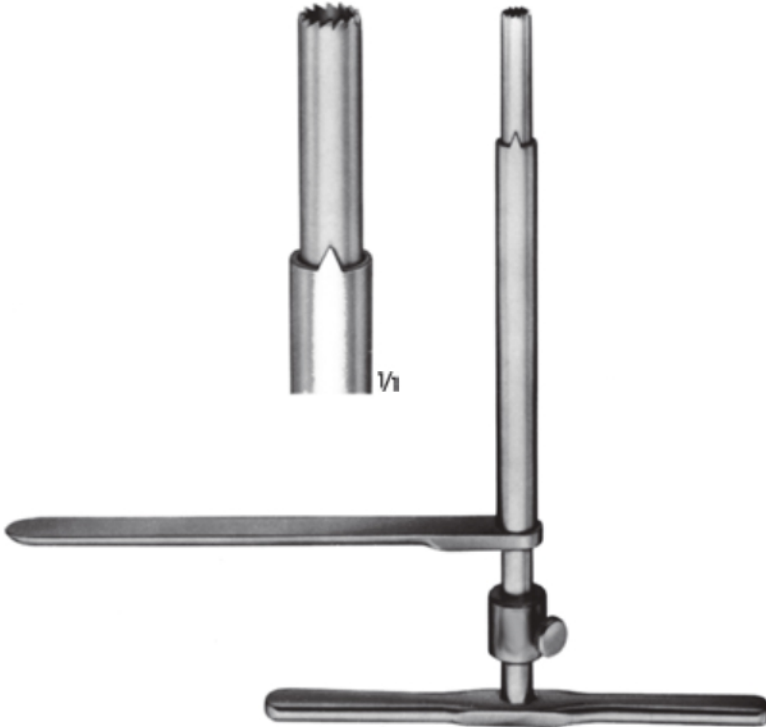

R.N.O.H.
60-189
Kemik biyopsi trapanı
Bone biopsy trephine
19.5 cm



1/2



60-190
İç çap/İnside Ø 3.9 mm
Dış çap/Outside Ø 5 mm



60-191
İç çap/İnside Ø 6.4 mm
Dış çap/Outside Ø 8 mm

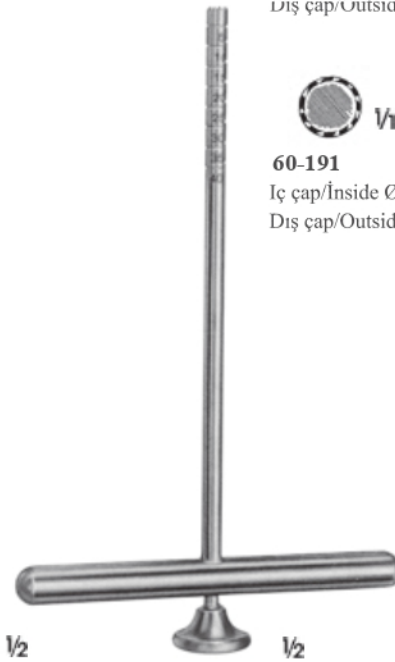

1/2

Kemik biyopsi trapanı
Bone biopsy trephine
16 cm





Ayarlı sap
Adjustable handle

60-192

El matkabı/Hand drill only
28 cm



60-193
Anahtar/Key

El matkabı paslanmaz, 3 çene ağızlı, 6.35 mm çaplı başlıklar için uygundur. Orjinal 'Jacops Chuck' aynaları ile ve **60-193** anahtarı ile, anahtarlı veya anahtarsız kullanılabilir.
Hand drill, stainless, original 'Jacops Chuck' and key
Can be used with or without the key.

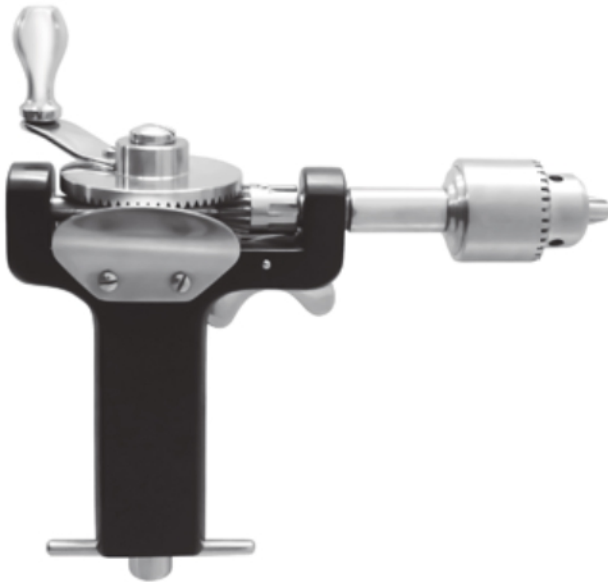

60-195
Anahtar/Key

BUNNEL

60-194

Küçük el matkabı, KIRSCHNER tel için delikli küçük el matkabı, 3 çene ağızlı, 4 mm çaplı başlıklar için uygundur.
Small hand drill, canulated for KIRSCHNER wires, with 3-jaw chuck, to fit any size of shanks up to 4.0 mm diameter.

60-195 anahtarı ile

With key T
16 cm



60-196
20 cm

60-197
25 cm



60-198
20 cm

60-199
25 cm



60-200
20 cm

60-201
25 cm



60-202
20 cm

60-203
25 cm



60-204
20 cm

60-205
25 cm



3.5 mm



60-206
20 cm

60-207
25 cm



2.5 mm



60-208
Ø 2.7 mm
15 cm

60-209
Ø 3.5 mm
17 cm

60-210
Ø 4.0 mm
20 cm

60-211
Ø 4.5 mm
22 cm

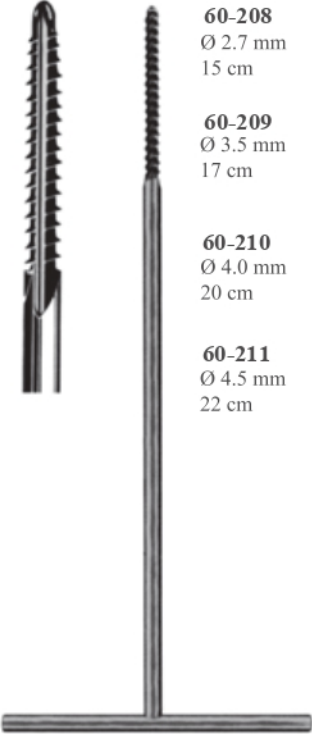

Kemik tapları/Bone taps



60-212
15.5 cm

Ölçme sınırı
Measuring
6 - 40 mm

Vidalar için
For screws
Ø 2.7 mm
Ø 3.5 mm
Ø 4.0 mm



60-213
22 cm

Ölçme sınırı
Measuring
10 - 60 mm

Vidalar için
For screws
Ø 4.5 mm
Ø 6.5 mm



60-214
Plak tutucu pens
Plate holding forceps
20 cm



Elmas Kesici Ağız
With Carbide Cutting Edges



60-215
1.5 mm



60-216
20 cm



60-217
ile kullanılır.
To be use with



60-218
Ø 2.5 mm



60-219
Pin/Pin

Kılavuz/Guide
23 cm

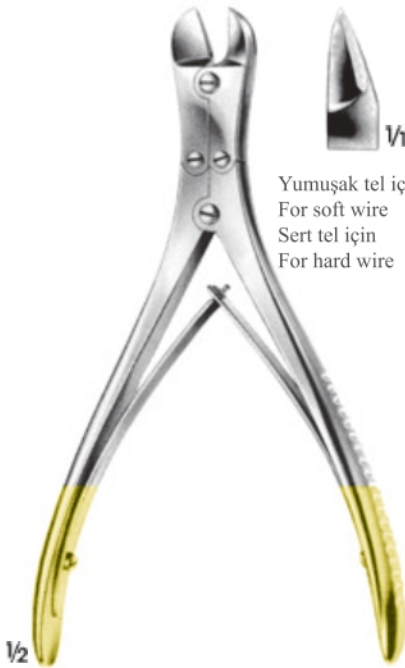

Yumuşak tel için Ø 2.0 mm
For soft wire Ø 2.0 mm
Sert tel için Ø 1.5 mm
For hard wire Ø 1.5 mm

1/2

REILL
60-220
Kemiğe yakın olan telleri kesme
For cutting off wires close to the bone
17.5 cm



60-221
15 cm

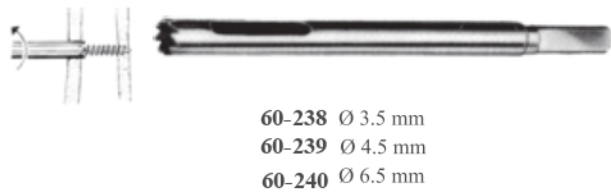
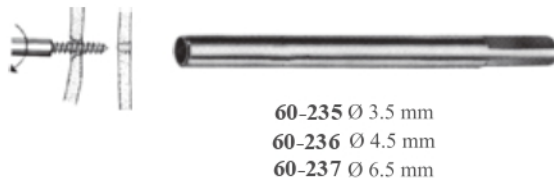
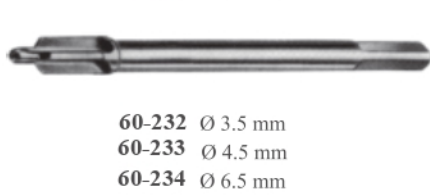
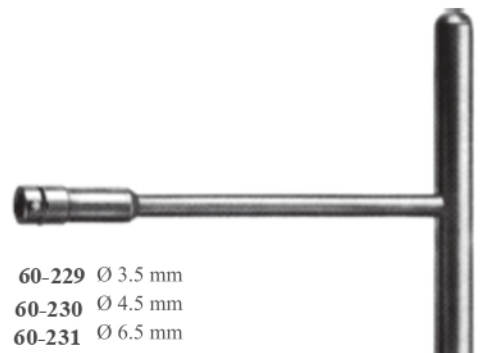
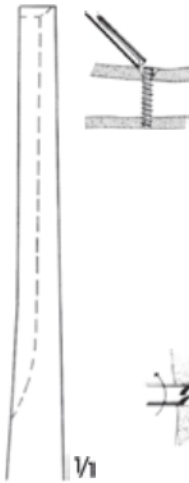

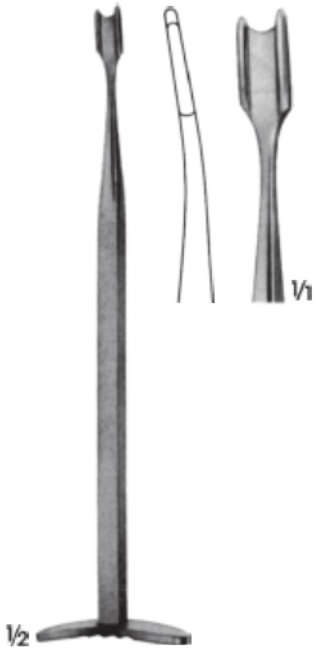

SMILLIE
60-241
Menisküs bıçak
Meniscus knife
17 cm

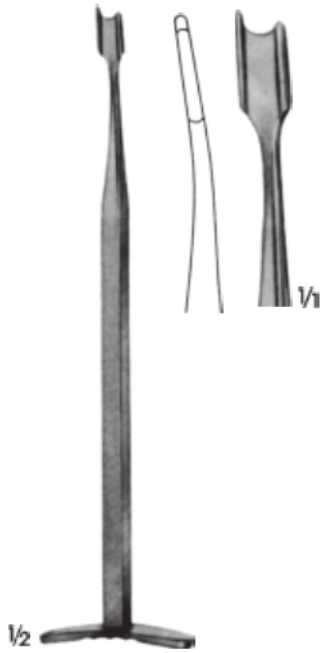

SMILLIE
60-242
Menisküs bıçak
Meniscus knife
17 cm

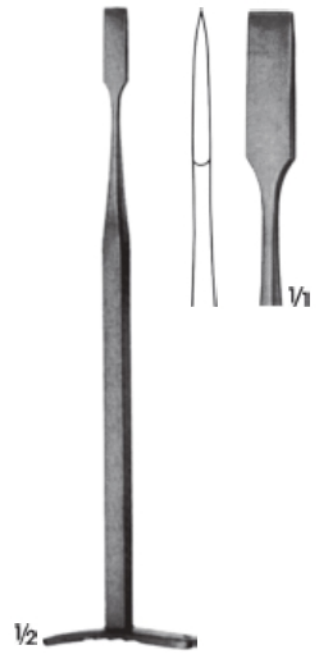

SMILLIE
60-243
Menisküs bıçak
Meniscus knife
17 cm

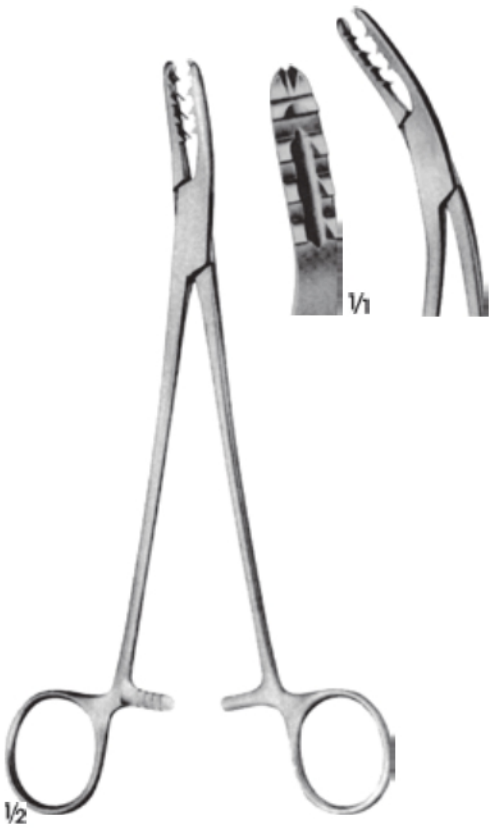

BIRCHER-GANSKE
60-244
Menisküs pensi
Meniscus forcep
20 cm

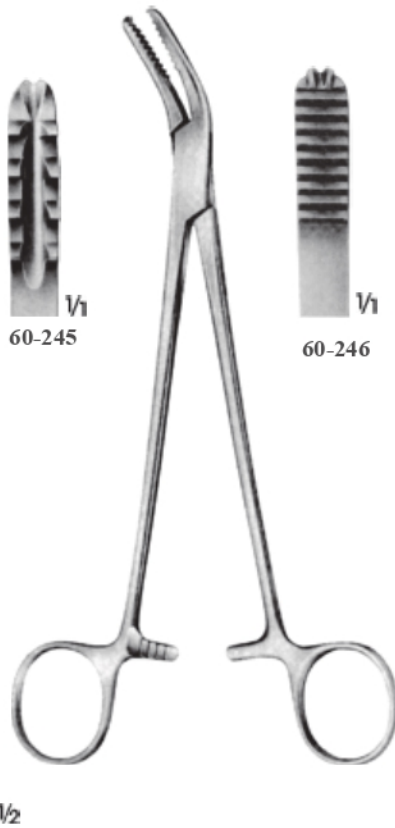

WELLER
Menisküs pensi
Meniscus forcep
20 cm



60-247
Menisküs pensi
Meniscus forcep
20.5 cm

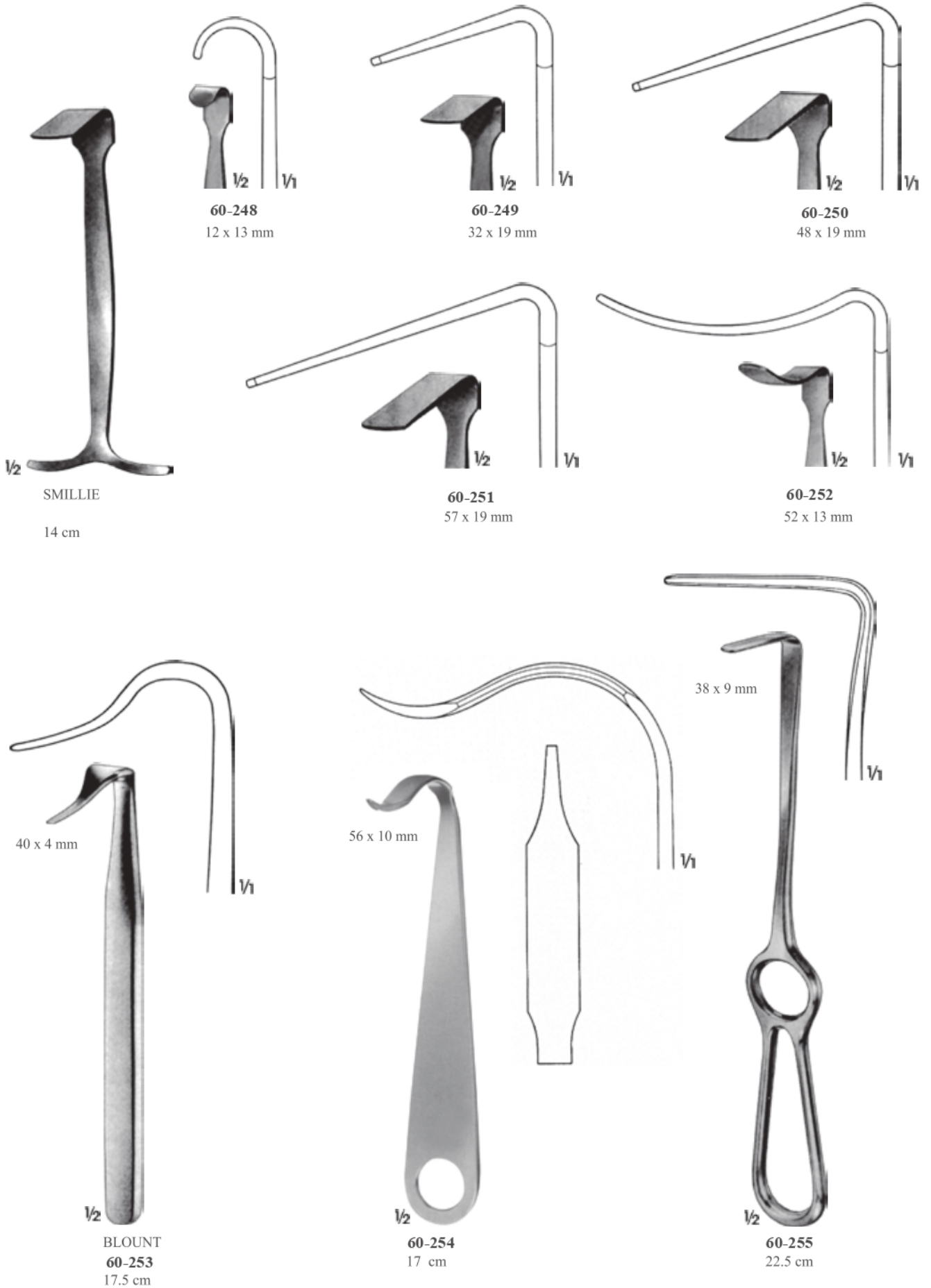



60-256
Kalça ekartörü
Hip retractor



60-257
Zincirli ağırlık
Weight with chain
1 kg



60-258
Çıkartıcı/Extractor
25 cm



60-259
Çıkartıcı/Extractor
27 cm



60-260
İtici/Pusher
25 cm



60-261
MORE protez çıkartıcı
MORE protheses extractor
50 cm



Osteotom ve guj
Chisel and gouge
35 cm



60-262
5 mm



60-263
7 mm



60-264
10 mm



Osteotom/Çizil
Osteotome/Chisel



60-265
5 mm



60-266
7 mm



60-267
10 mm



Guj/Gouge



60-268
5 mm



60-269
7 mm



60-270
7 mm



Guj/Gouge



60-271
Çement itici
Cement pusher
30 cm



60-272
Çement itici
Cement pusher
30 cm



60-273 Ø 7 mm
60-274 Ø 9 mm
60-275 Ø 11 mm
Çement çıkartıcı
Cement extractor
60 cm

60-276 Ø 6 mm
40 cm

60-277 Ø 8 mm
40 cm

60-278 Ø 10 mm
40 cm

60-279 Çekiç / Mallet
22 cm

60-280 40 cm

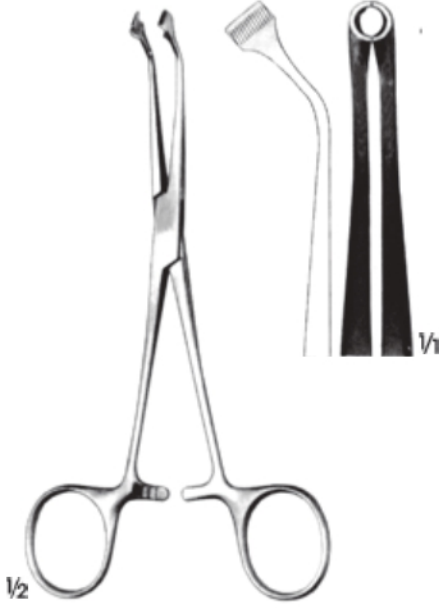

HERZ
60-281
Tendon tutucu pens
Tendon seizing forcecp
15.5 cm



60-282
Tendon geçmeli pens
Tendon interlacing forcecp
15 cm

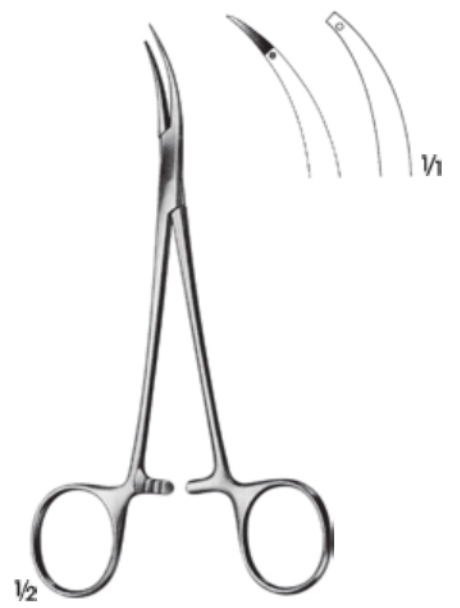

60-283
Tendon geçmeli pens
Tendon interlacing forcecp
15 cm



SYSTRUNK
60-284
Parmak tırnak kesme makası
Scissors for splitting finger nails
13 cm

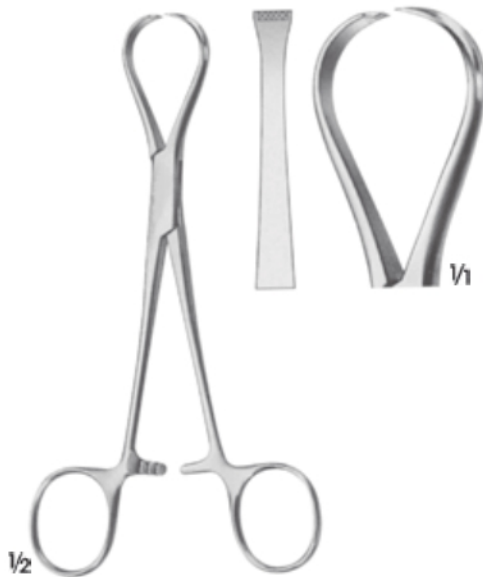

JACKSON
60-285
Tendon tutucu pens
Tendon seizing forcecp
4 x 5 diş/4 x 5 teeth
15 cm



JOSEPH
60-286
El testere
Hand saw
17 cm



LINDEMANN
60-287
El testere
Hand saw
20 cm





REILL
60-288 Ø 4 mm
Tendon stripper
Tendon stripper
Şaft uzunluğu
Shaftlänge 35 cm
Toplam boy
Shaft length 39.5 cm



ASSMUS
60-289 Ø 3 mm
Sinir stripper, Künt
Nerve stripper, blunt
Şaft uzunluğu
Shaftlänge 35 cm
Toplam boy
Shaft length 39.5 cm



60-290 Ø 3 mm
Tendon stripper
Tendon stripper
Şaft uzunluğu
Shaftlänge 19 cm
Toplam boy
Shaft length 30 cm



60-291 Ø 5 mm
Tendon stripper
Tendon stripper
Şaft uzunluğu
Shaftlänge 39 cm
Toplam boy
Shaft length 49.5 cm



BUNNELL
60-292 Ø 2 mm
60-293 Ø 3 mm
60-294 Ø 4 mm
60-295 Ø 6 mm
 13.5 cm

60-296 Ø 3 mm
60-297 Ø 5 mm
 30 cm

60-298 Ø 5 mm
 50 cm

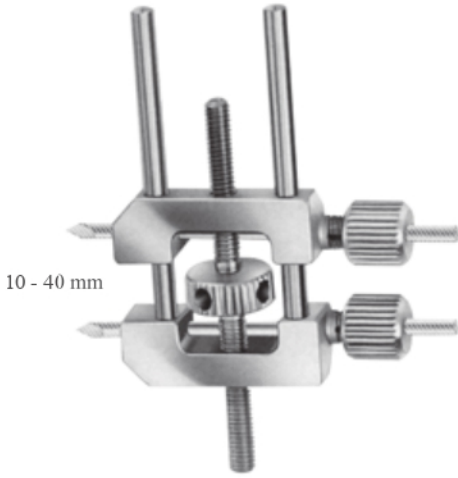

10 - 40 mm

60-299
Küçük distraktör
Small distractor
Tel Ø 3.0 mm
For wires Ø 3.0 mm



60-300
Sabitleme diski kanallı
Fixation disc, slotted



60-301
Aliminyum, x ışınlarını
geçirgen
Fixation disc, slotted idem,
alüminyum transparent to
X-rays



60-302
Sabitleme diski, kanallı
Fixation disc, slotted



60-303
Kavrama çeneli tel gerdirme aleti
Wire tightener with clamping jaws



60-304
Tespit klempini için/For fixation clamp



60-305
Büyük boy traksiyon kancası
Large size traction hook



60-306
Küçük boy traksiyon kancası
Small size traction hook



60-307
Traksiyon yayı anahtarı
Wrench, double-ended, for wire

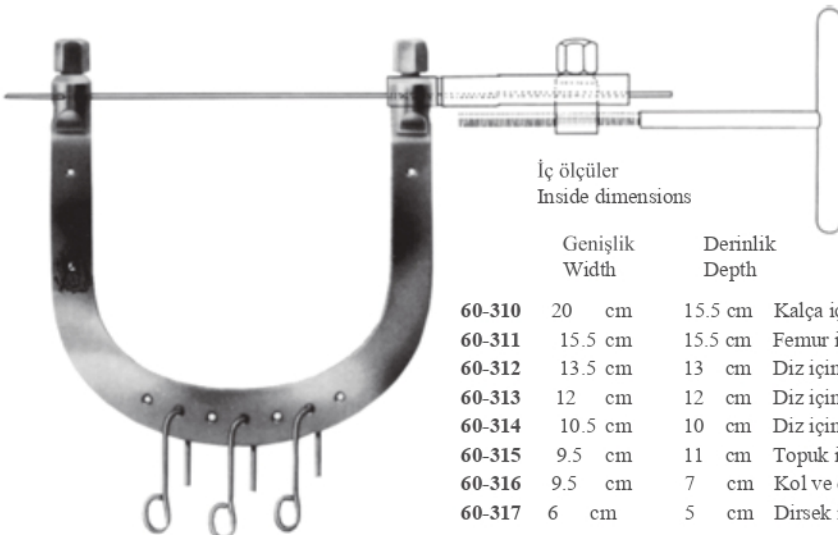

KIRSCHNER

3 kancalı, Ø 2.5 mm'ye kadar KIRSCHNER
teli ile kullanılan çekirme
Wire traction bows, to be used with KIRSCHNER
wires up to Ø 2.5 mm, with 3 hooks

İç ölçüler
Inside dimensions

	Genişlik Width	Derinlik Depth	
60-310	20 cm	15.5 cm	Kalça için/For the hip
60-311	15.5 cm	15.5 cm	Femur için/For the femur
60-312	13.5 cm	13 cm	Diz için/For the knee
60-313	12 cm	12 cm	Diz için/For the knee
60-314	10.5 cm	10 cm	Diz için/For the knee
60-315	9.5 cm	11 cm	Topuk için/For the calcaneus
60-316	9.5 cm	7 cm	Kol ve dirsek için/For the arm and elbow
60-317	6 cm	5 cm	Dirsek için, çocuklar için/For the elbow child size

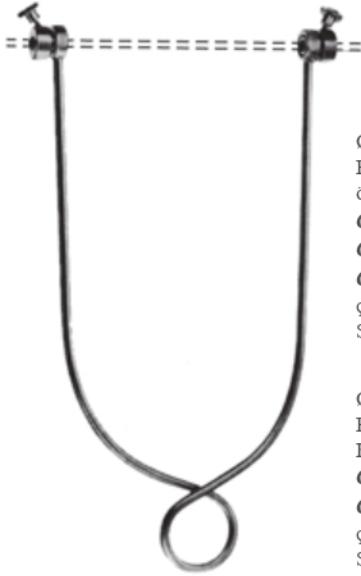

Ø 4 mm STEINMANN çivileri için
For Ø 4 mm STEINMANN pins Kol
ölçüleri/Arms dimensions
60-319 16 x 9 cm
60-320 21 x 11 cm
60-321 21 x 15 cm STEINMANN
çivileri hariç Except for
STEINMANN pins

Ø 5 mm STEINMANN çivileri için
For Ø 5 mm STEINMANN Pins
Kol ölçüleri/Arms dimensions
60-322 16 x 9 cm
60-323 21 x 11 cm STEINMANN
çivileri hariç Except for
STEINMANN pins



60-318
Sabitleme diskleri için tomavida
Screw driver for fixation discs

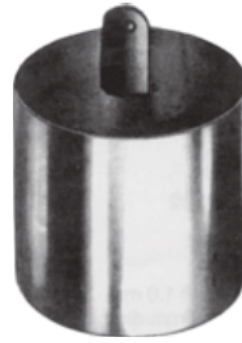

60-324 1 kg
60-325 2 kg
60-326 5 kg
Ağırlık/Weight



60-327
Ayarlı küçük boy, üç kancalı traksiyon aleti
Wire traction bow, adjustable, with 3 hooks,
small size

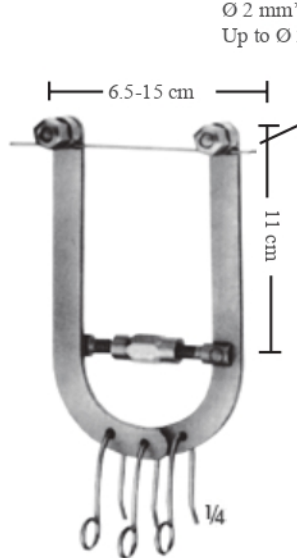

60-328
Ayarlı küçük boy, üç kancalı traksiyon aleti
Wire traction bow, adjustable, with 3 hooks,
small size

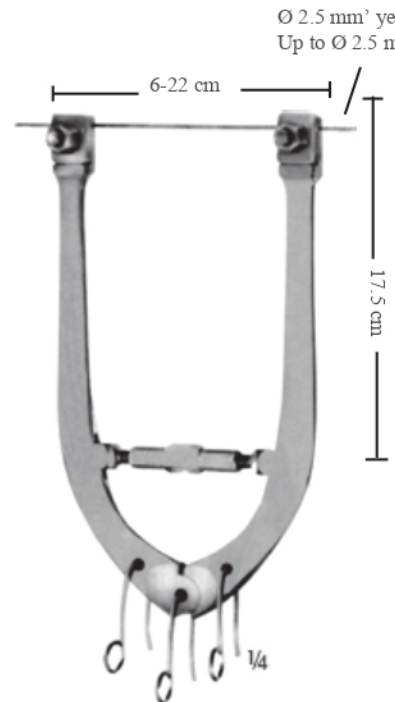

60-329
Ayarlı büyük boy, üç kancalı traksiyon aleti
Wire traction bow, adjustable, with 3 hooks,
large size



60-331
Yedek bleyd
Spare blade

60-330
Parmak yüzük testere
Finger ring saw
15 cm



60-332
Tırnak çıkarma pensi
Nail extracting forceps
13.5 cm

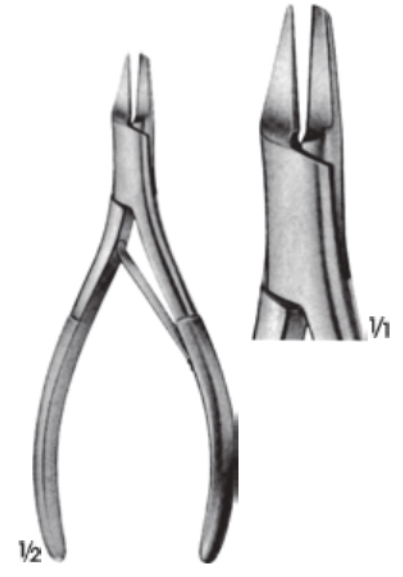

60-333
Tırnak çıkarma pensi
Nail splitting forceps
13 cm

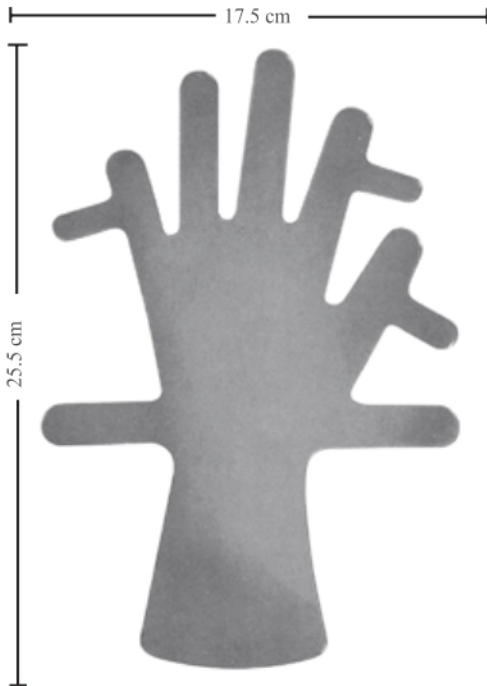

60-334
Çocuklar için el sabitleyici, yumuşak
Children's hand control, soft

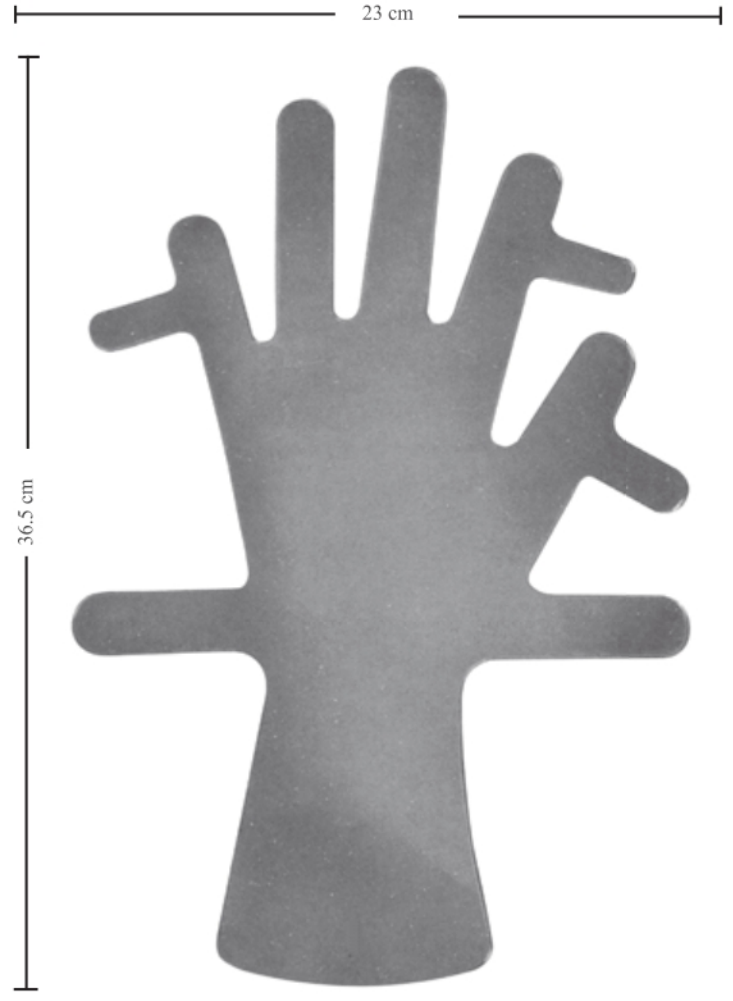

60-335
Yetişkinler için el sabitleyici, yumuşak
Used stabilizer for adults, soft

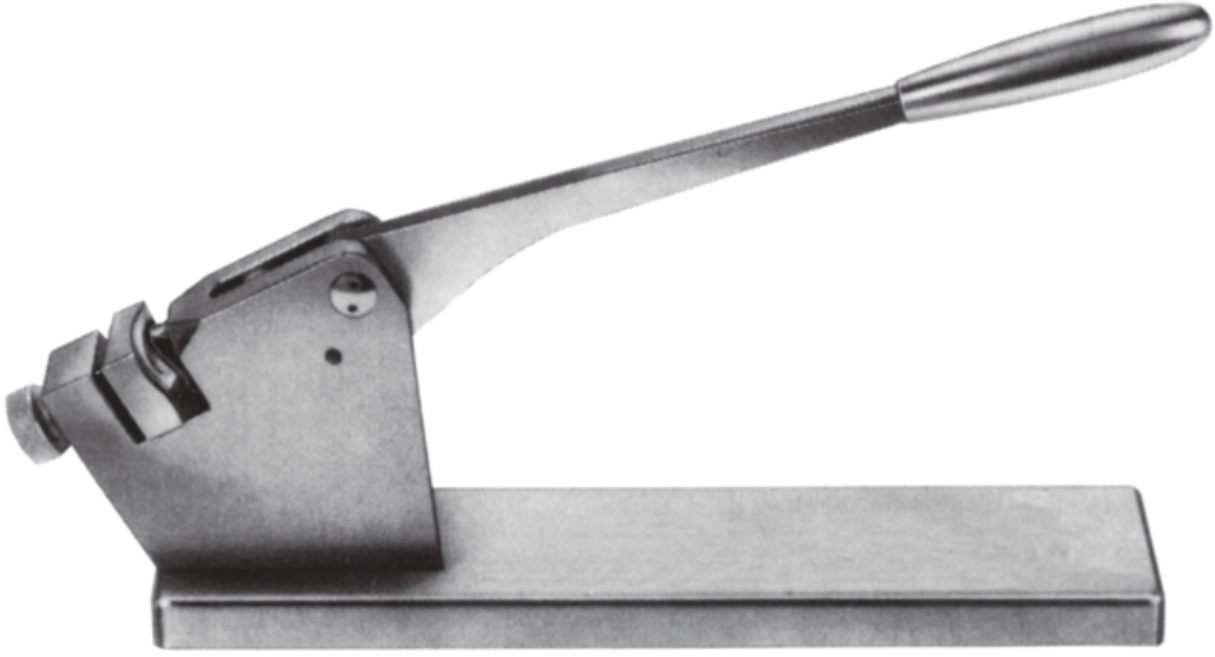

60-336
Bükme ve kıvrırma aparatı
Plate bending and contouring device



60-337
Bükme kolu
Bending iron
14 cm



60-338
Bükme kolu
Bending iron
14 cm



60-339
Bükme kolu
Bending iron
16 cm

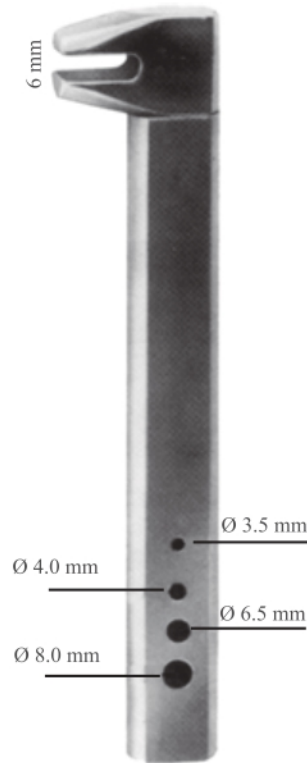

JEWETT
60-340
Bükme kolu
Bending iron
20 cm



JEWETT
60-341
Bükme kolu
Bending iron
20 cm





ASCLASS

ASCLASS CERRAHİ ALETLER İMALAT SAN. VE TİC. LTD.ŞTİ

 [asclasscerrahialetler.ve.medya](https://www.instagram.com/asclasscerrahialetler.ve.medya)  [Asclass cerrahi aletler](https://www.facebook.com/Asclasscerrahi.aletler)  www.asclassgrup.com  info@asclassgrup.com - asclassmedya@gmail.com

 Çatalarmut Mahallesi Sezgin Sokak No:7 Kat:1/2/3 İlkadım/SAMSUN