



# ASCLASS

ASCLASS CERRAHİ ALETLER İMALAT SAN. VE TİC. LTD.ŞTİ

📍 Çatalarmut Mahallesi Sezgin Sokak No:7 Kat:1/2/3 İlkadım/SAMSUN

📱 asclasscerrahialetler.ve.medya 🌐 Asclass cerrahi aletler 🌐 www.asclassgrup.com 📧 info@asclassgrup.com - asclassmedya@gmail.com



# ÜRÜN GRUPLARIMIZ

- » Genel Cerrahi
- » Beyin Cerrahi
- » Ortopedi Cerrahi
- » Göz Cerrahi
- » Kulak Burun Boğaz
- » Jinekoloji
- » Üroloji
- » Kalp Damar
- » Üniversal Ekartör Setleri
- » Laparoskopik Ekartör Setleri
- » Laparoskopik El Aletleri
- » Steril Konteynir Sistem

**53**



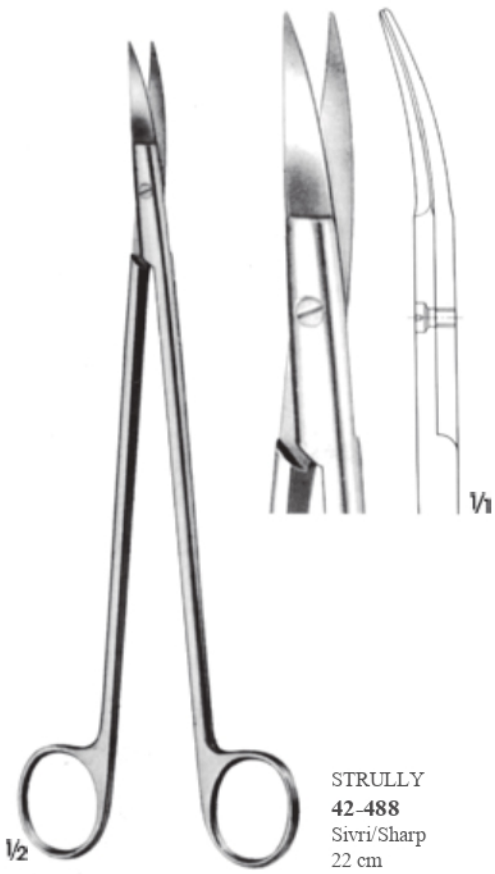

STRULLY  
42-488  
Sivri/Sharp  
22 cm

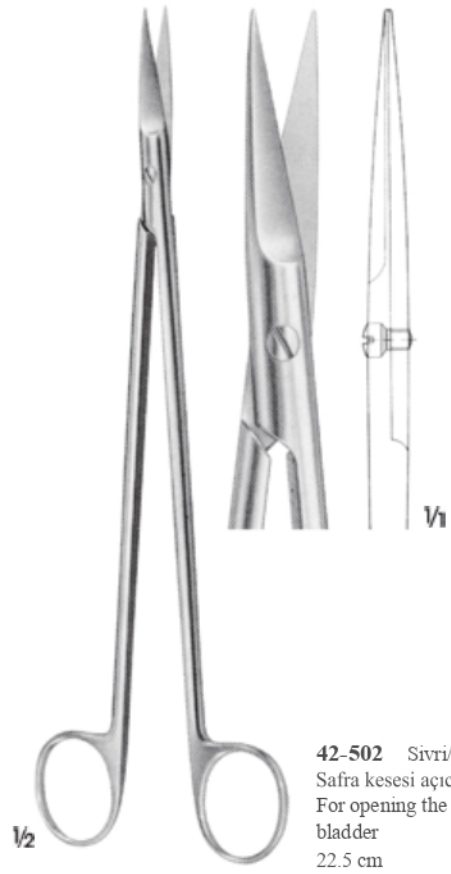

42-502 Sivri/Sharp  
Safra kesesi açıcı  
For opening the gall  
bladder  
22.5 cm

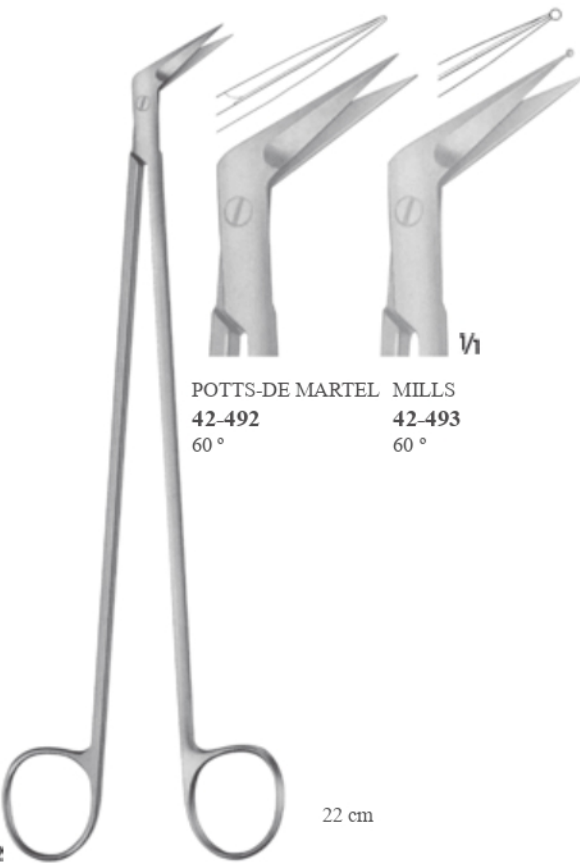

POTTS-DE MARTEL MILLS  
42-492 60°  
42-493 60°

22 cm

Hard Tips



DE BAKEY  
42-344  
22 cm





**DESJARDINS  
45-403**  
Ur kanalı ve kistik pens  
Gall duct and cystic forceps  
22 cm



**NISSSEN  
45-404**  
Ur kanalı ve kistik pens  
Gall duct and cystic forceps  
21.5 cm



**LAHEY(SWEET)  
45-432**  
20 cm



**LAHEY  
45-426**  
22.5 cm

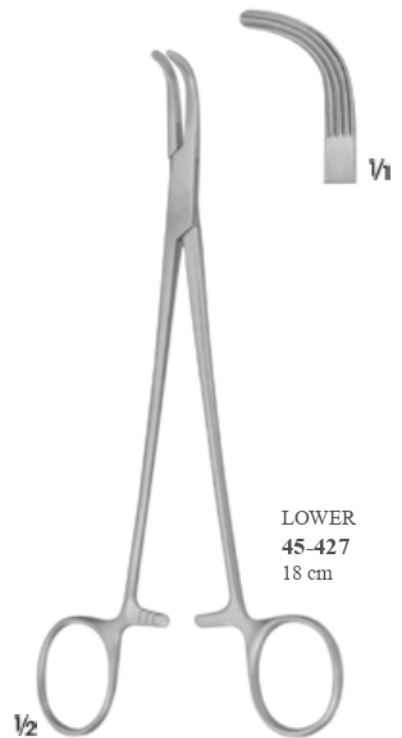

**LOWER  
45-427**  
18 cm



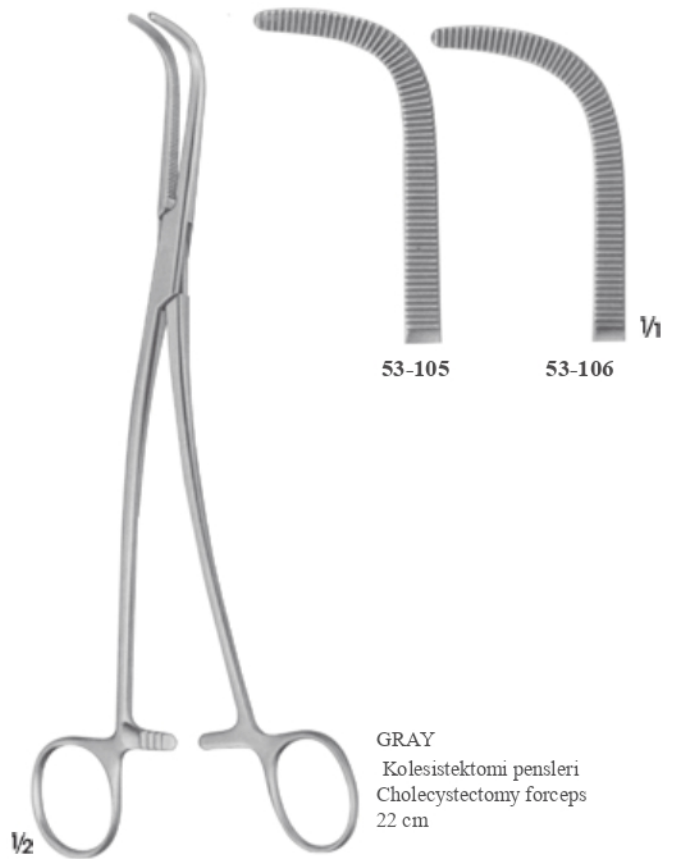
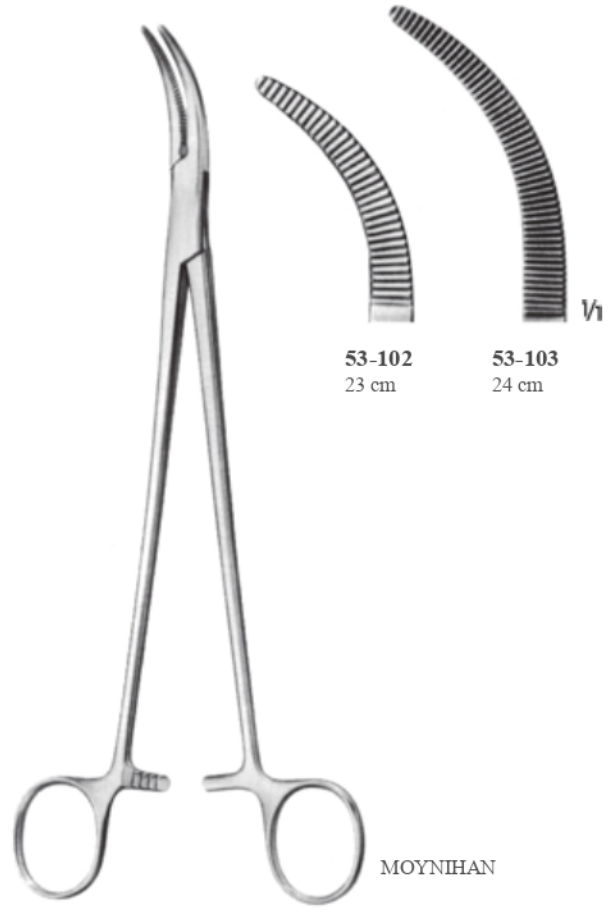
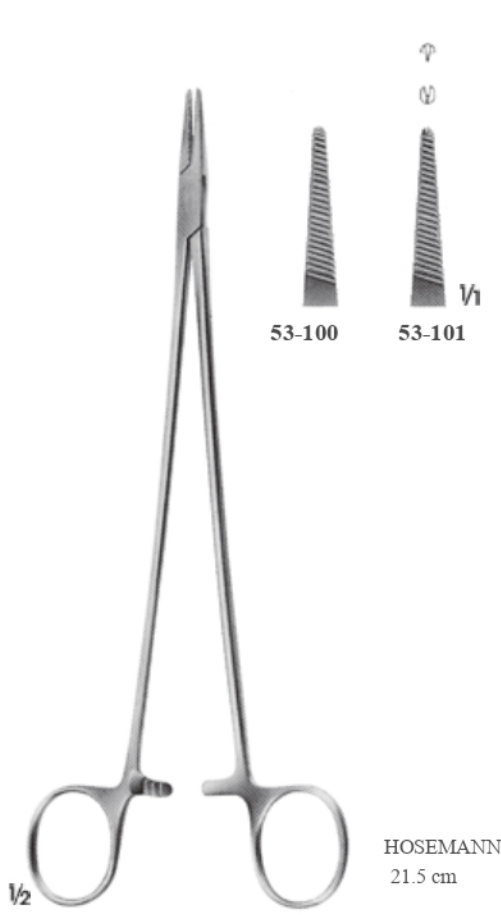



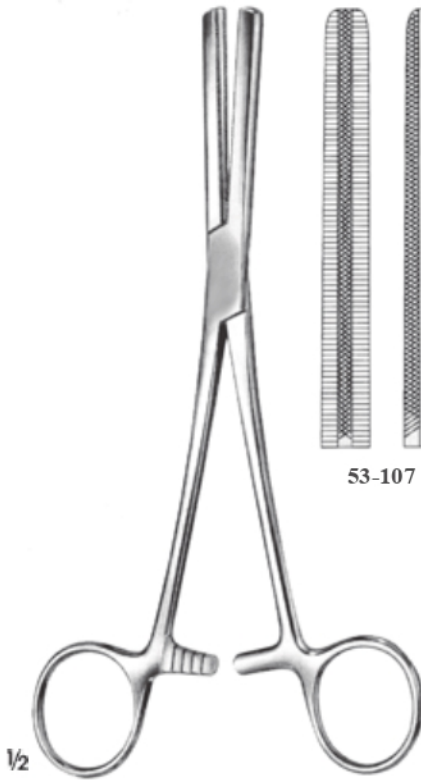

FERGUSSON  
53-107 - 53-108  
Basınç klempleri  
Pressure clamps  
20 cm

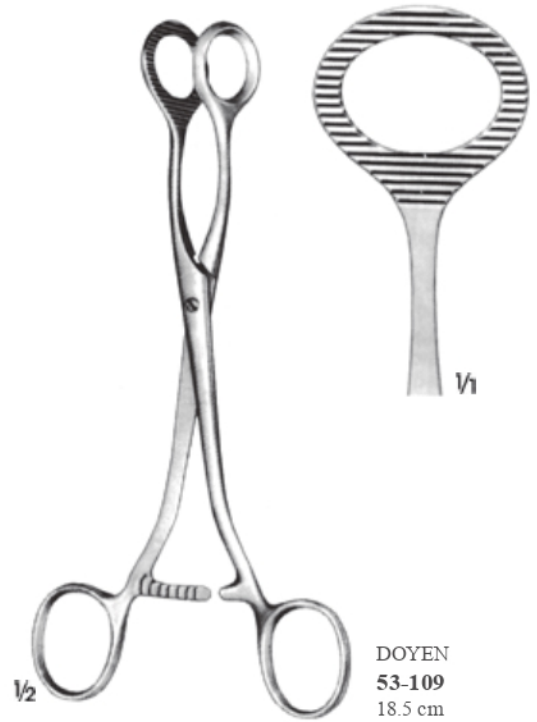

DOYEN  
53-109  
18.5 cm

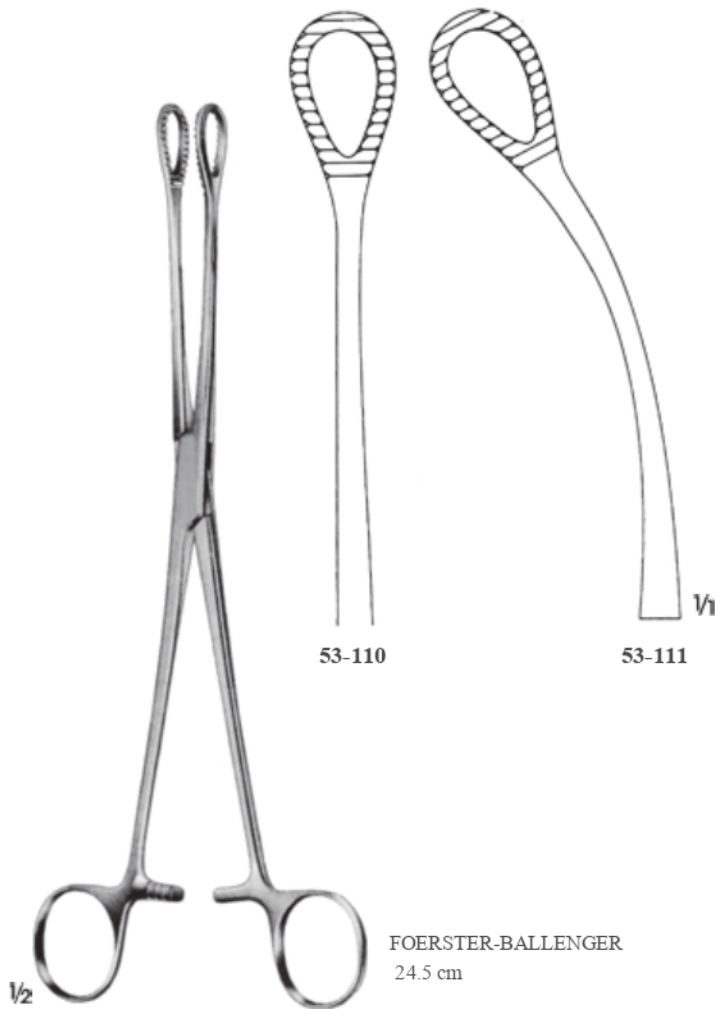

FOERSTER-BALLENGER  
24.5 cm

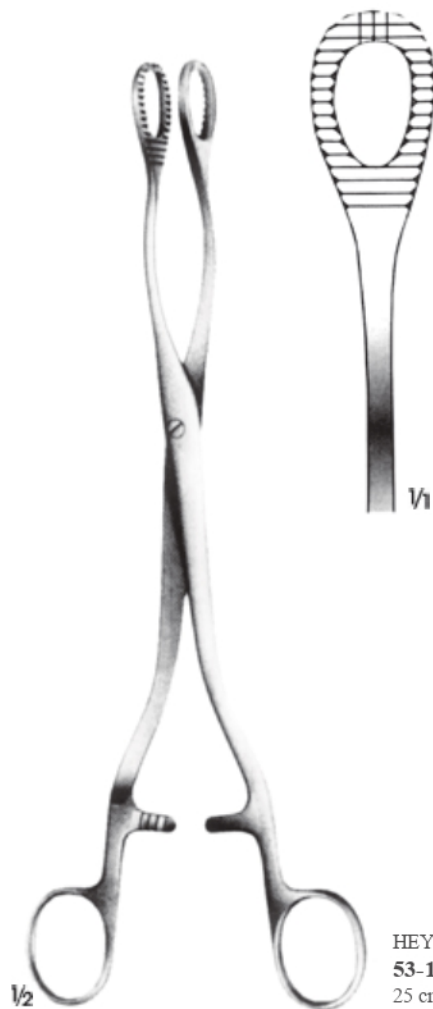

HEYWOOD-SMITH  
53-112  
25 cm



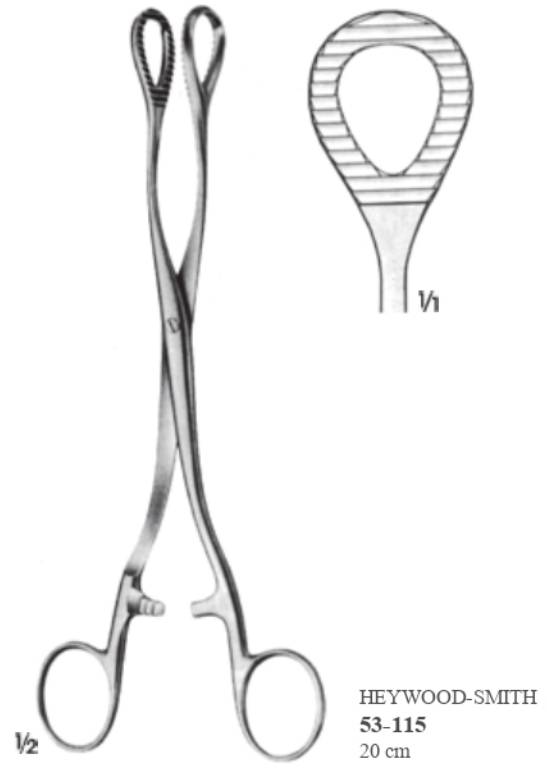
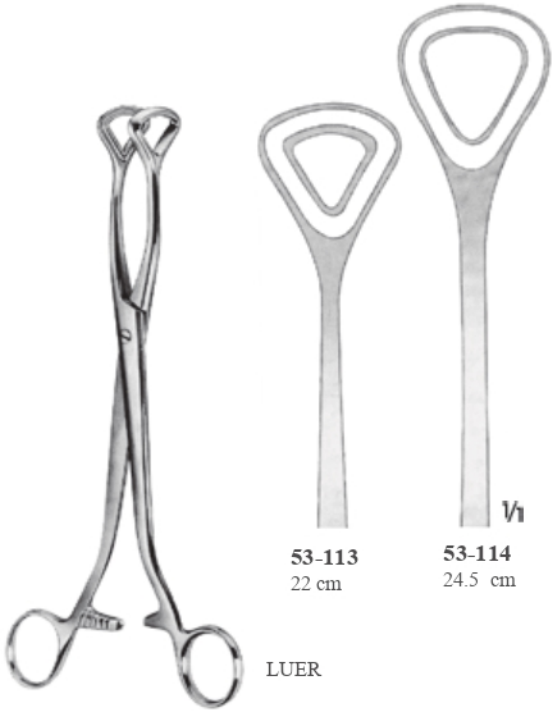

Atromatik  
Atraumatic

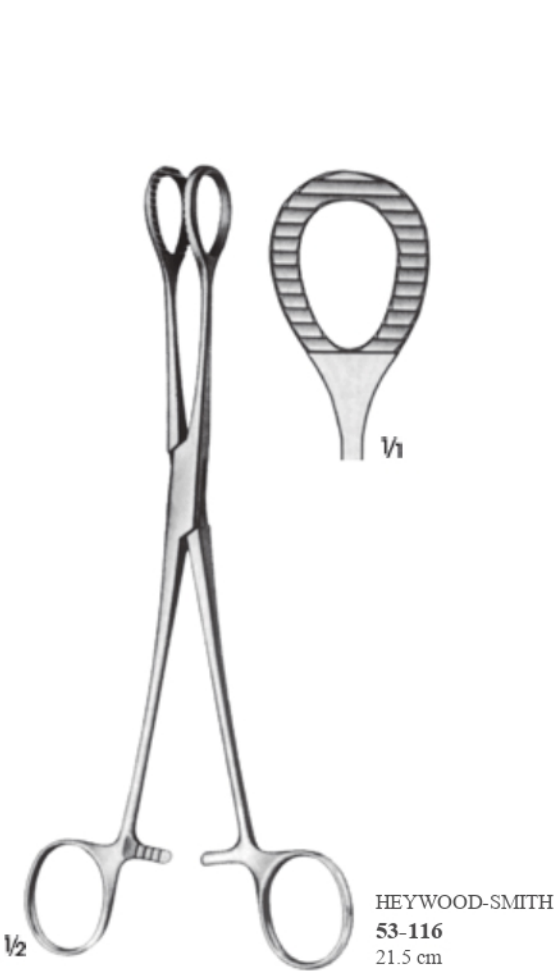



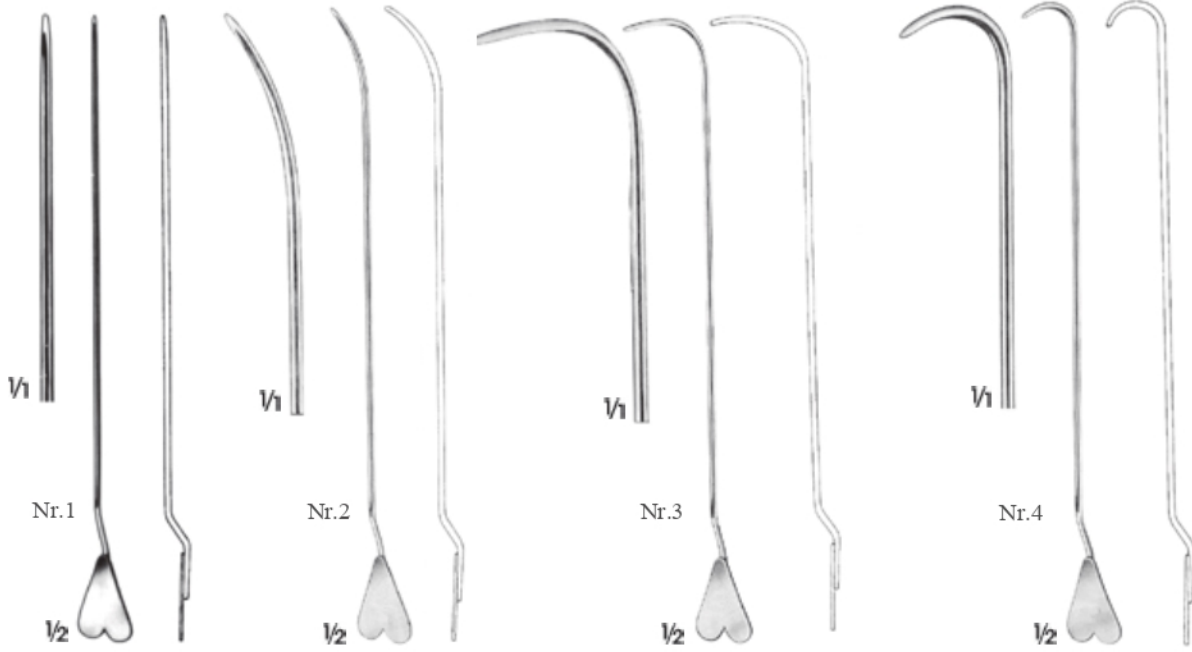

**LOCKHART-MUMMERY**

Fistül sonda/Fistula probes

**53-119** Nr.1 Düz/Straight

**53-120** Nr.2 45° Eğri/Curved

**53-121** Nr.3 90° Eğri/Curved

**53-122** Nr.4 Geriye doğru eğri/Curved retrograde  
16.5 cm

Ø 3.5 mm



**BIRODIE**  
**53-123**  
20 cm

Ø 3 mm



**53-124** Bükülebilir/  
Malleable 19 cm



**53-125**  
Çift delikli ve uçlu  
bükülebilir sonda  
Double ended probe,  
malleable, with hole  
19 cm



**53-126**  
Fistül sonda  
Fistula probe  
24 cm





**53-127**  
Ø 3.5 mm



**HAJEK**

Sulama kanülü  
Irrigating cannula  
16.5 cm



**DESJARDINS**

Safra kanalı sondaları, esneyebilir  
Gall duct probes, flexible  
28.5 cm

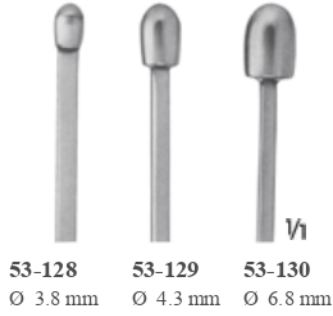

**53-128** Ø 3.8 mm  
**53-129** Ø 4.3 mm  
**53-130** Ø 6.8 mm

Ø 5 mm



**MAYNIHAN**  
**53-131**

Safra taşı sondası, kaşık ağızlı  
bükülebilir  
Gall stone probe and-scoop  
of tin, malleable  
36.5cm

Ø 3.5 mm

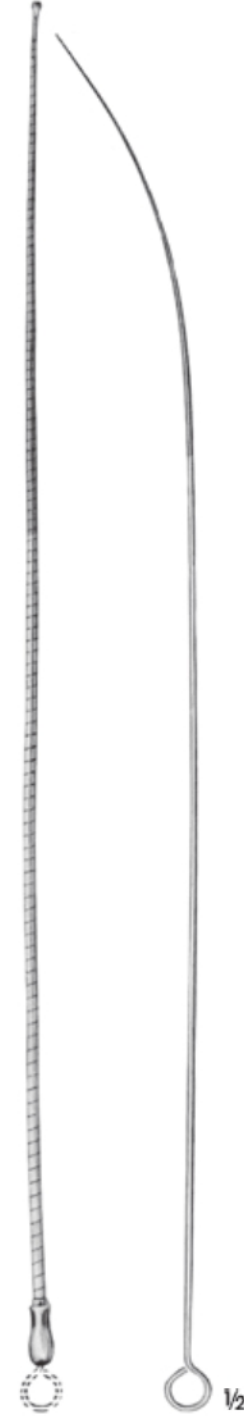

**OCHSNER**  
**53-132**

Safra kanalı sonda  
esneyebilir  
Gall duct probe, flexible  
40 cm

Ø 5 mm



**MAYO**  
**53-133**

Safra kanalı sonda  
bükülebilir  
Gall duct probe,  
malleable  
33 cm





**53-134**  
Katater kılavuz  
Catheter guide  
49 cm



Erkekler için metal  
katater Male catheters,  
metal  
29 cm

	Char.
<b>53-135</b>	8
<b>53-136</b>	10
<b>53-137</b>	12
<b>53-138</b>	14
<b>53-139</b>	16
<b>53-140</b>	18
<b>53-141</b>	20



Bayanlar için metal  
katater Female catheters,  
metal  
15.5 cm

	Char.
<b>53-142</b>	6
<b>53-143</b>	7
<b>53-144</b>	8
<b>53-145</b>	9
<b>53-146</b>	10
<b>53-147</b>	11
<b>53-148</b>	12
<b>53-149</b>	13
<b>53-150</b>	14
<b>53-151</b>	15
<b>53-152</b>	16
<b>53-153</b>	18
<b>53-154</b>	20

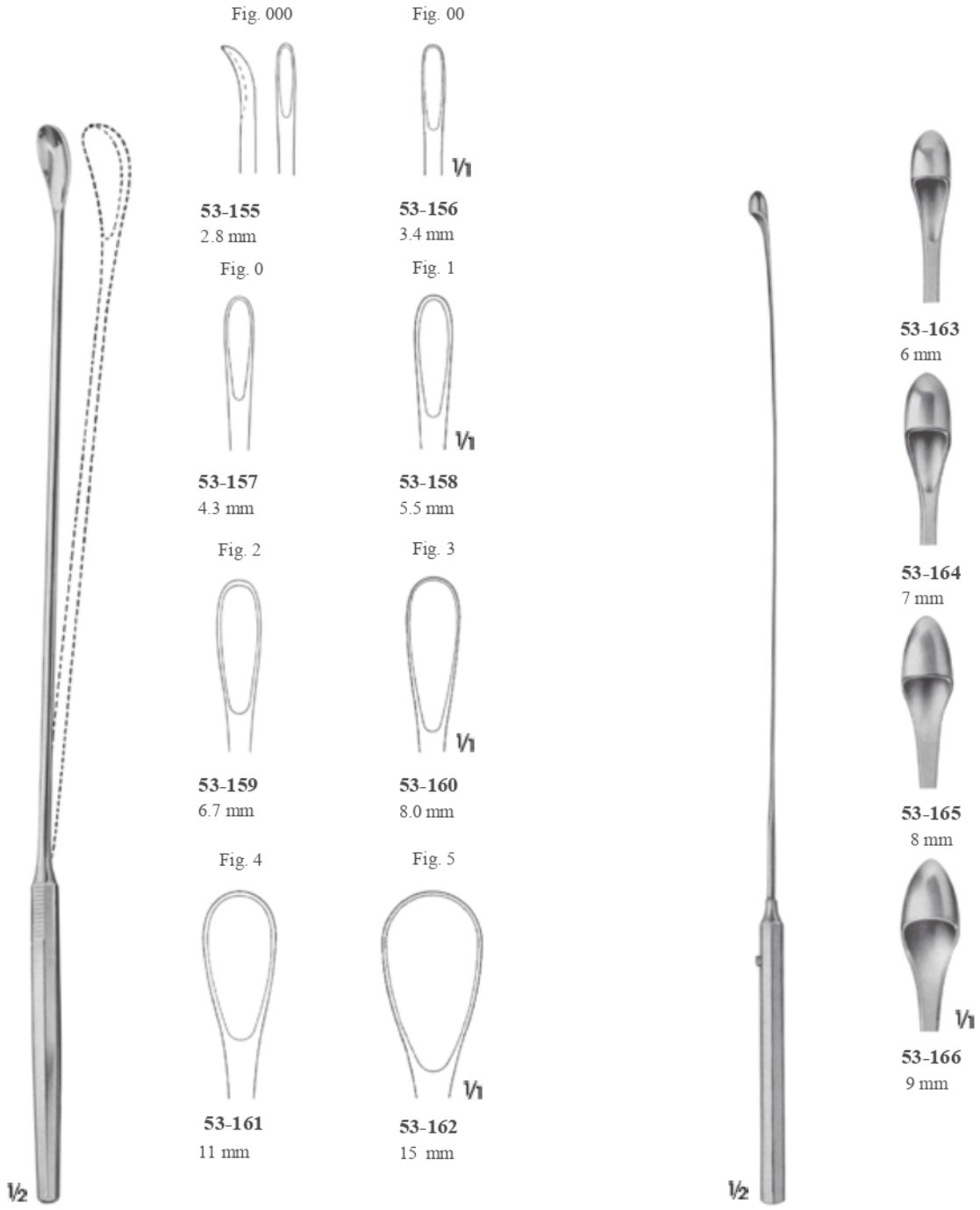

**LUER-KÖRTE**  
Bükülebilir/Malleable  
31 cm

**DESJARDINS**  
Esnek şaft sonda ve yakalayıcı  
Probe and catch with flexible shaft  
30 cm



DITTEL

Metal buji ve dilatasyon sondaları  
Metal bougies and dilating sounds  
34.5 cm

- |        |    |
|--------|----|
| 53-167 | 8  |
| 53-168 | 9  |
| 53-169 | 10 |
| 53-170 | 11 |
| 53-171 | 12 |
| 53-172 | 13 |
| 53-173 | 14 |
| 53-174 | 15 |
| 53-175 | 16 |
| 53-176 | 17 |
| 53-177 | 18 |
| 53-178 | 19 |
| 53-179 | 20 |
| 53-180 | 21 |
| 53-181 | 22 |
| 53-182 | 23 |
| 53-183 | 24 |
| 53-184 | 25 |
| 53-185 | 26 |
| 53-186 | 27 |
| 53-187 | 28 |
| 53-188 | 29 |
| 53-189 | 30 |

Charr.  
(French)



BAKES

Safra kanalı için bükülebilir dilatörler  
Common bile duct dilators, malleable  
31 cm

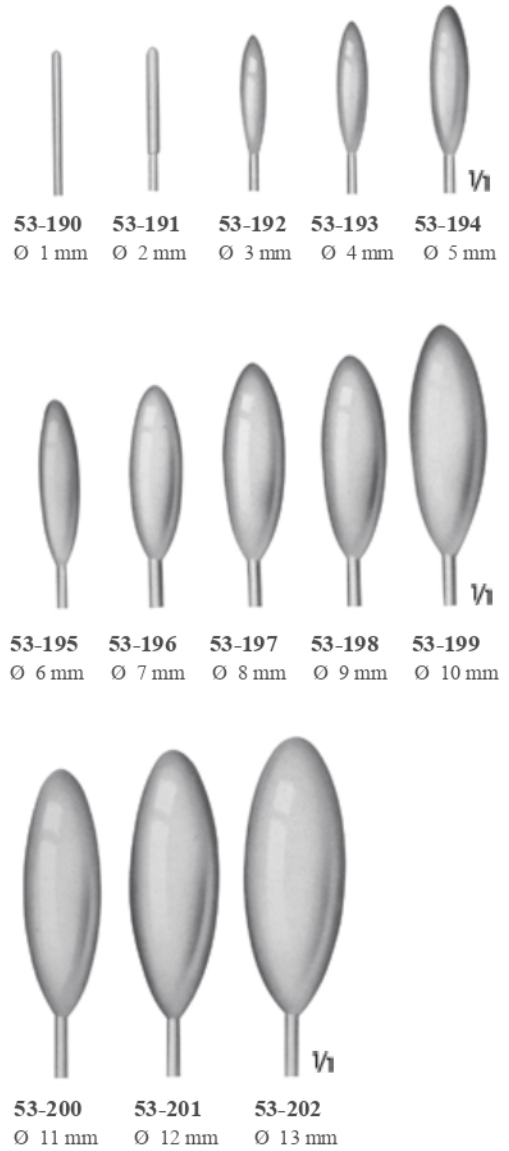



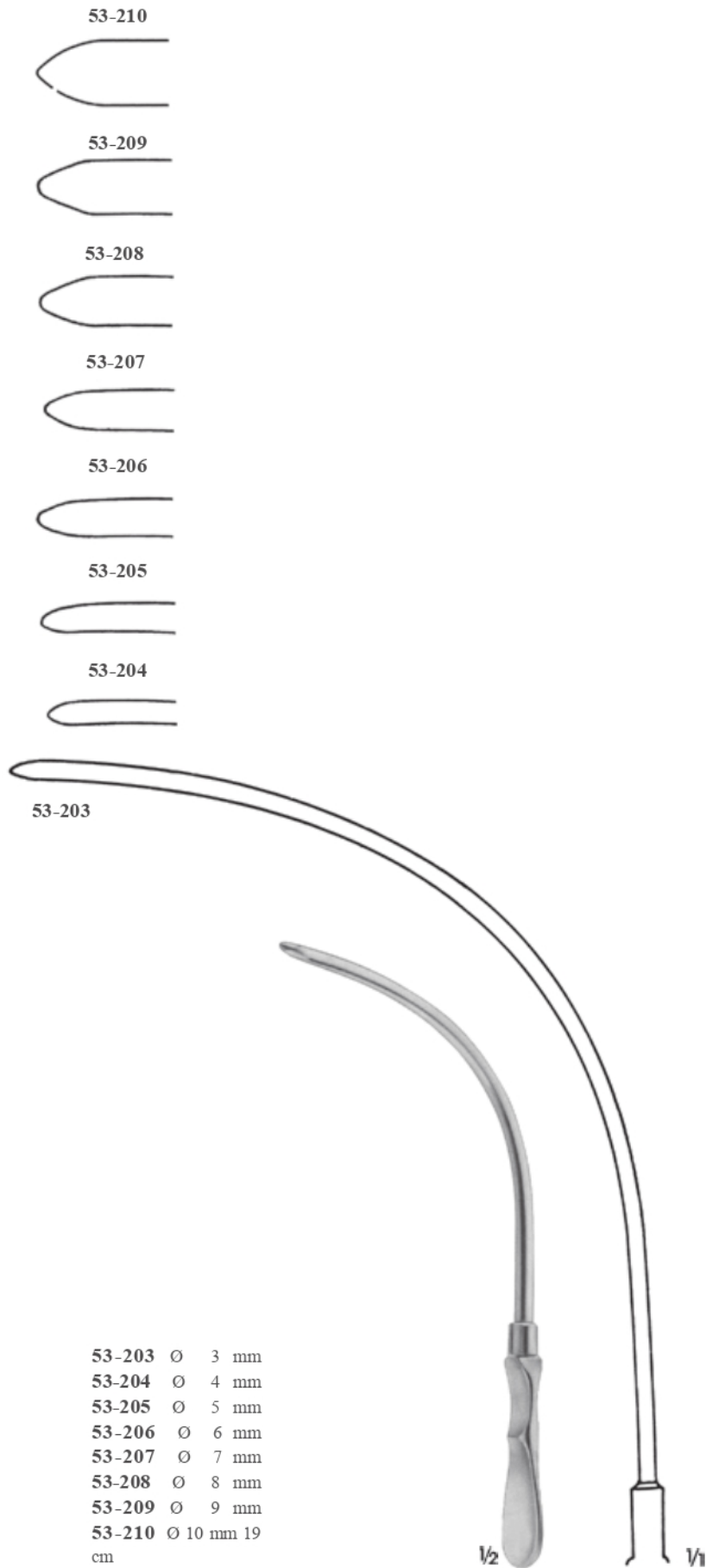

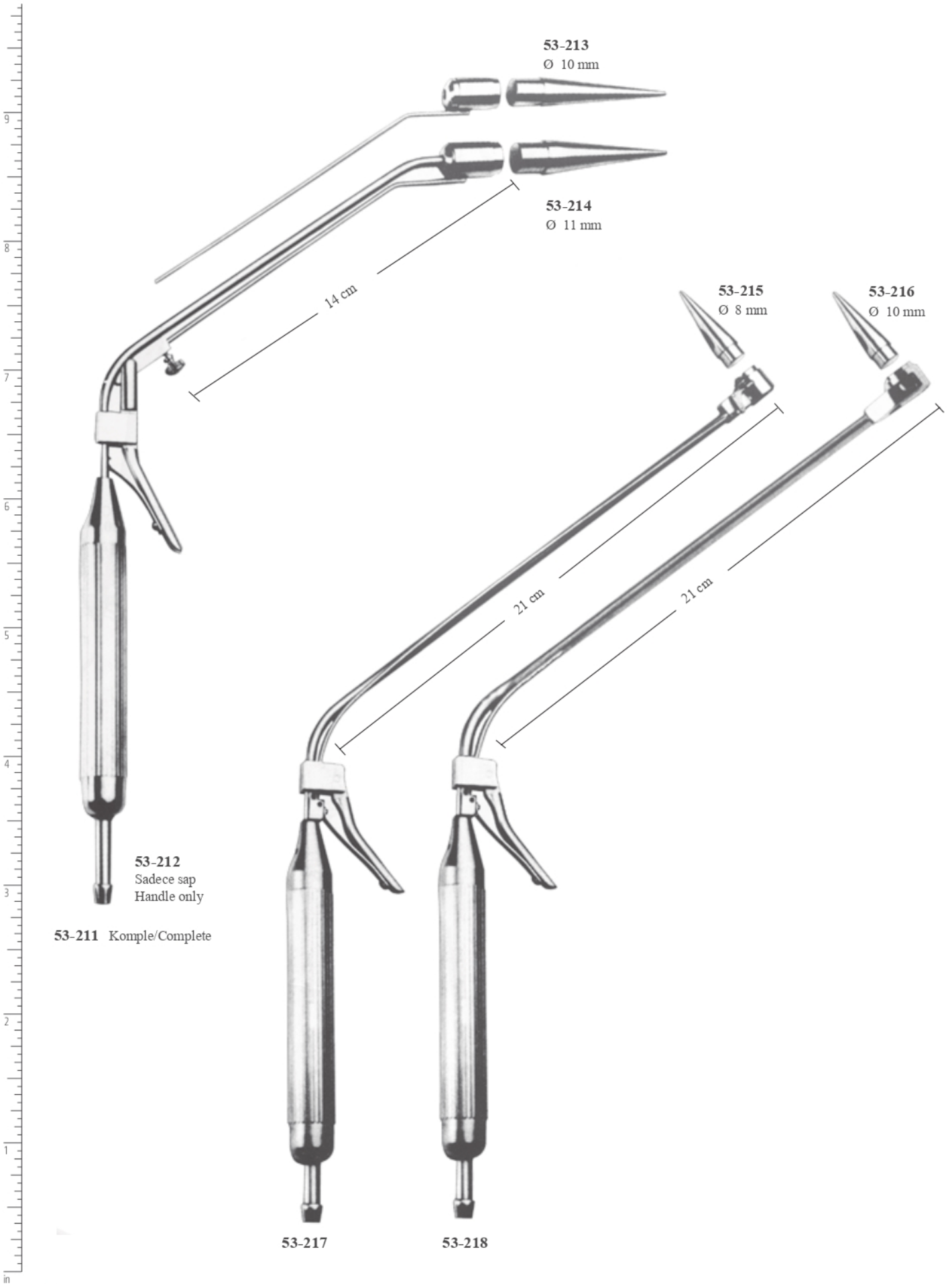

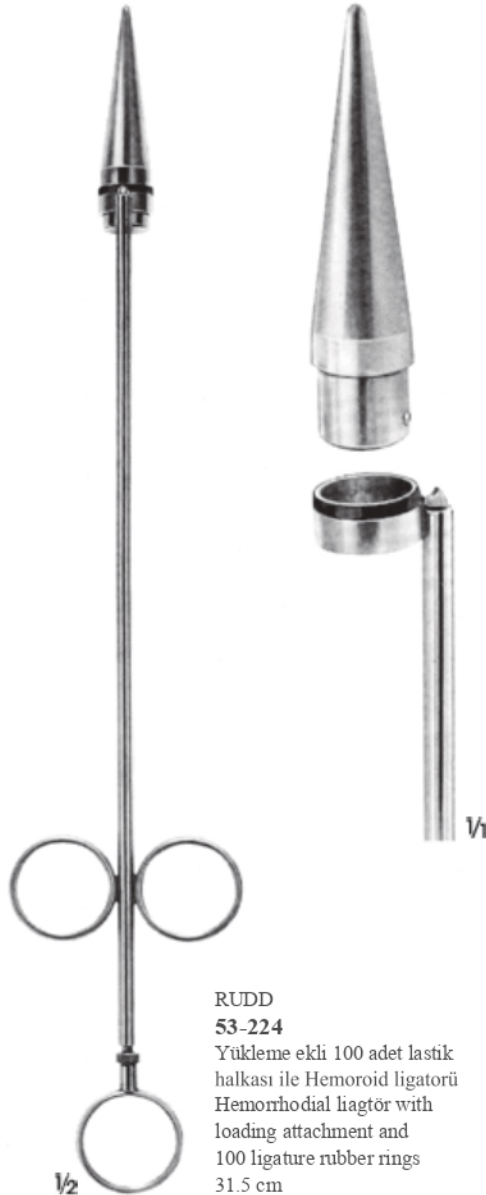
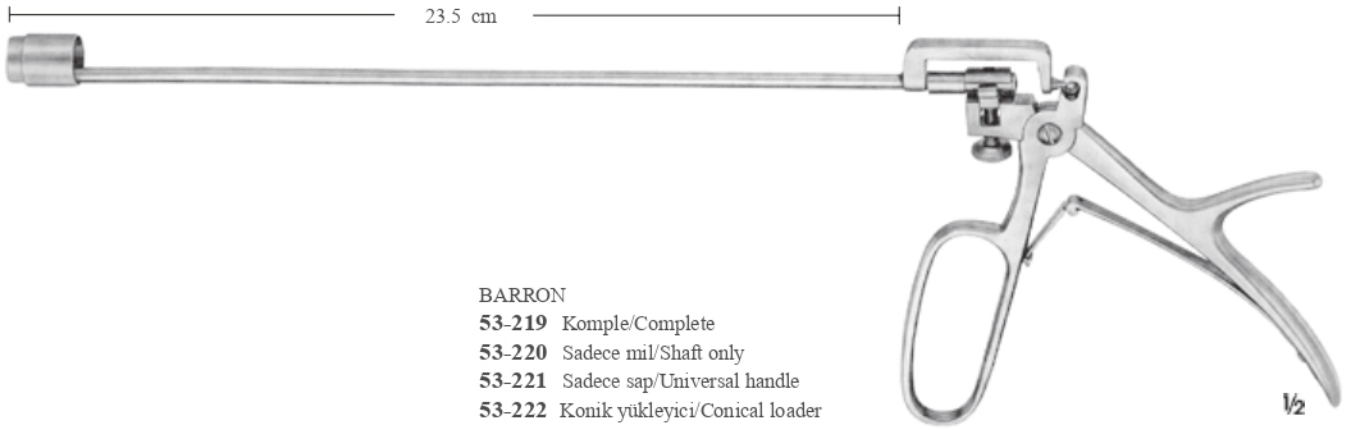



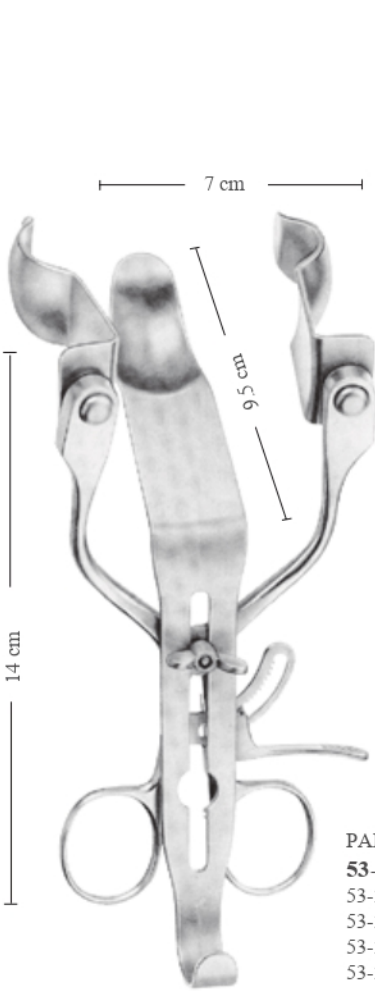

**PARKS**

- 53-226** Komple/Complete  
53-227 Sadece ekartör/Retractor only  
53-228 Orta bleyd/Center blade  
53-229 1 çift yan bleyd 70 mm/1 pair lateral blades 70  
53-230 1 çift yan bleyd 93 mm/1 pair lateral blades 93 mm

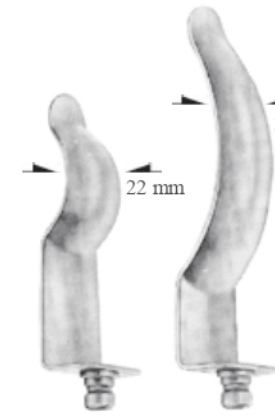

**53-229**  
Rektal bleyd  
Rectal blade  
70 mm



**53-230**  
Sfinker bleyd  
Sphincter blade  
93 mm



**53-231**  
Anostomoz bleyd  
Anostomosis blade  
90 mm



**53-232**  
150 mm

**53-232**  
Orta bleyd, soğuk ışık taşıyıcı bağlantılı  
Center blade, with connection for cold light carrier



**53-234**  
Soğuk ışık taşıyıcı, operasyon alanını yoğun aydınlatmak için  
Cold light carrier for additional, intensive illumination of the operating area

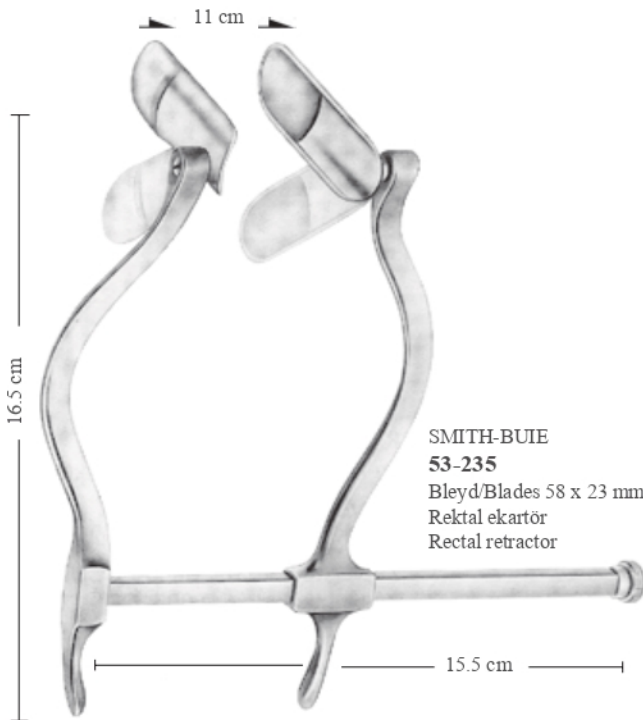

**SMITH-BUIE**  
**53-235**  
Bleyd/Blades 58 x 23 mm  
Rektal ekartör  
Rectal retractor

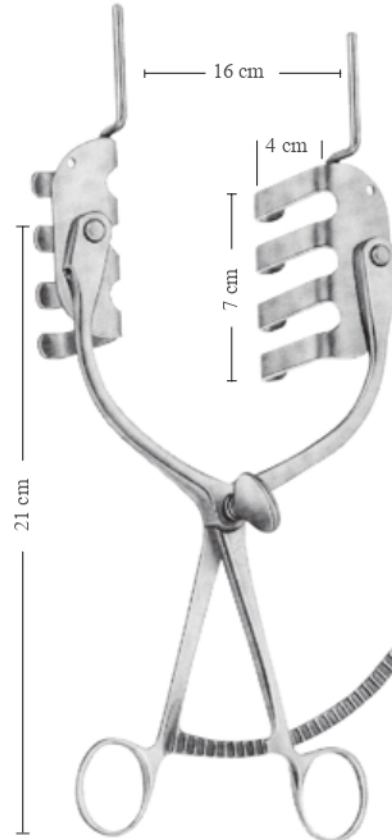

**ST.MARKS-GIRONA**  
**53-236**  
Perianal ekartör  
Perineal retractor

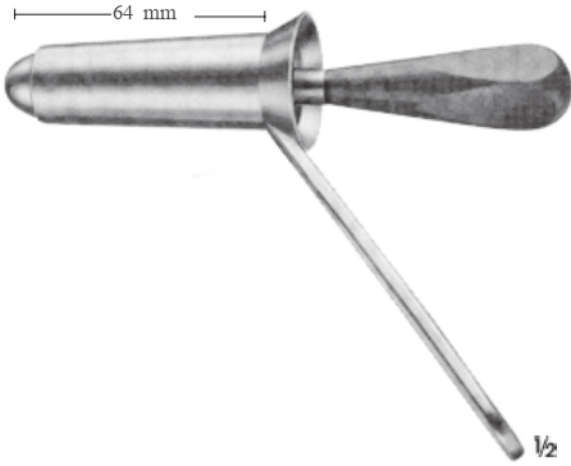

GABRIEL  
53-237 Ø 25 mm  
Rektal spekulum  
Rectal speculum

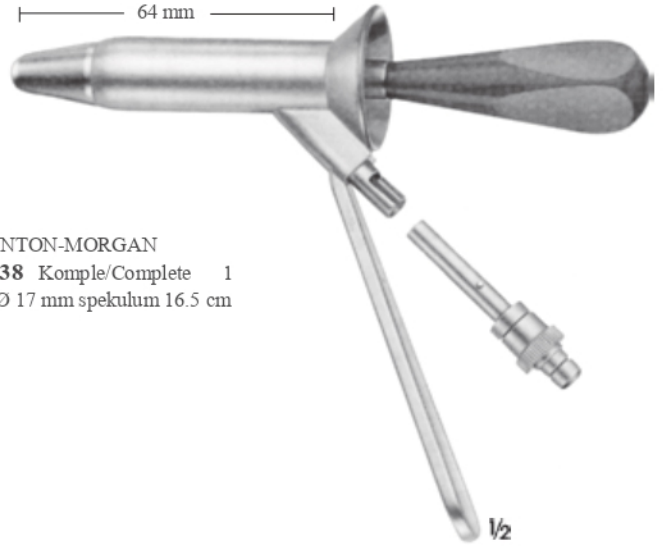

NAUNTON-MORGAN  
53-238 Komple/Complete 1  
adet Ø 17 mm spekulum 16.5 cm



53-239  
ACM İngiliz standartı fiber ışık taşıyıcı  
Fibre light attachment,  
ACM/British standard  
for NAUNTON-MORGAN specula

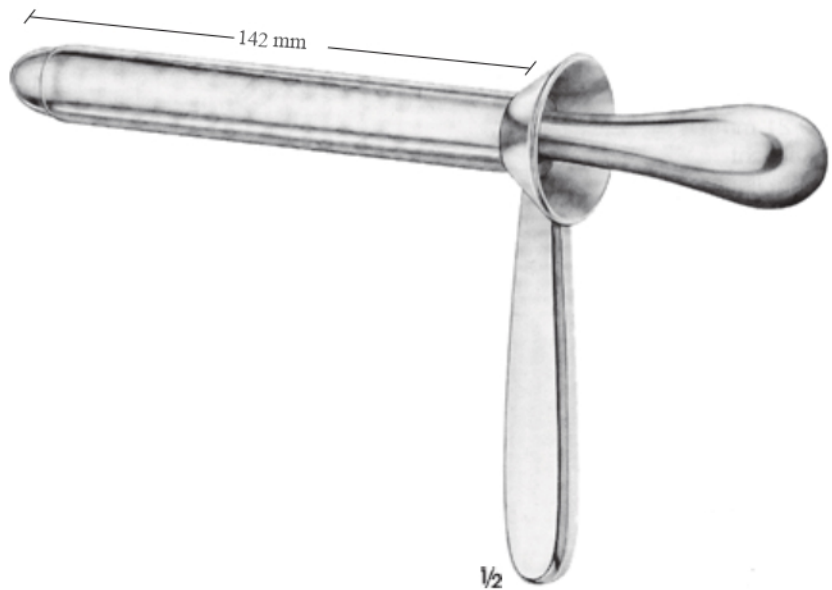

KELY  
53-240  
Proktoskop  
Proctoscope  
14 cm





**KELLY**  
**53-241** Ø 20 mm  
Anoskop/Anoscope  
16 cm



**KELLY**  
**53-242** Ø 25 mm  
Sfinteroskop/Sphincteroscope  
16 cm



**IVES-FANSLER**  
**53-243** Ø 24 mm  
Anoskop/Anoscope  
14.5 cm



**BENSAUDE**  
**53-244** Ø 17 mm  
**53-245** Ø 20 mm  
**53-246** Ø 23 mm  
Anoskoplar/Anoscopes  
18.5 cm





**HIRSCHMANN**  
**53-247** Ø 16 x 65 mm  
**53-248** Ø 19 x 65 mm  
**53-249** Ø 22 x 65 mm



**KELLY**  
**53-250** Ø 22 x 50 mm  
**53-251** Ø 22 x 100 mm  
**53-252** Ø 22 x 140 mm



100 x 10 mm

1/2

**COCK**  
**53-253**  
 19 cm



1/2

**SIMS**  
**53-254**  
 15 cm





1/2

SIMS  
53-255  
16 cm



1/2

SIMS  
53-256  
16 cm



1/2

PRATT  
53-257  
20.5 cm

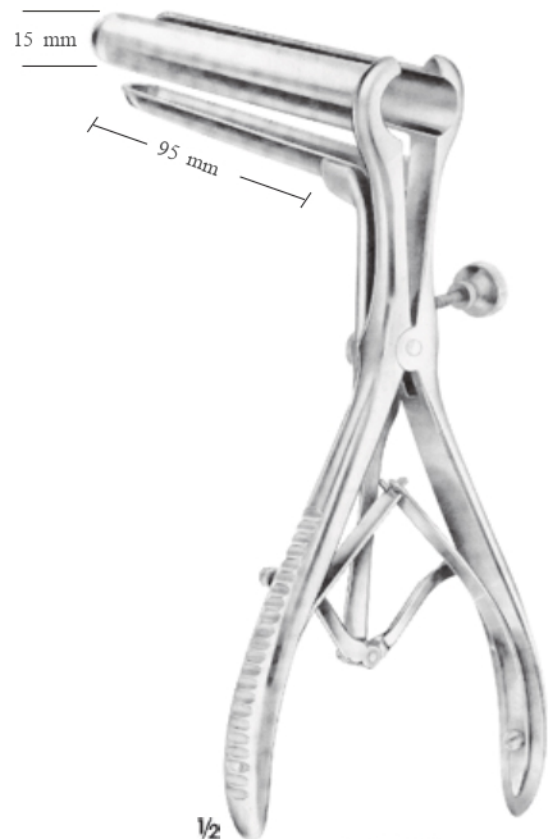

1/2

MATHIEU  
53-258  
21.5 cm





**CZERNY**  
**53-259**  
22.5 cm

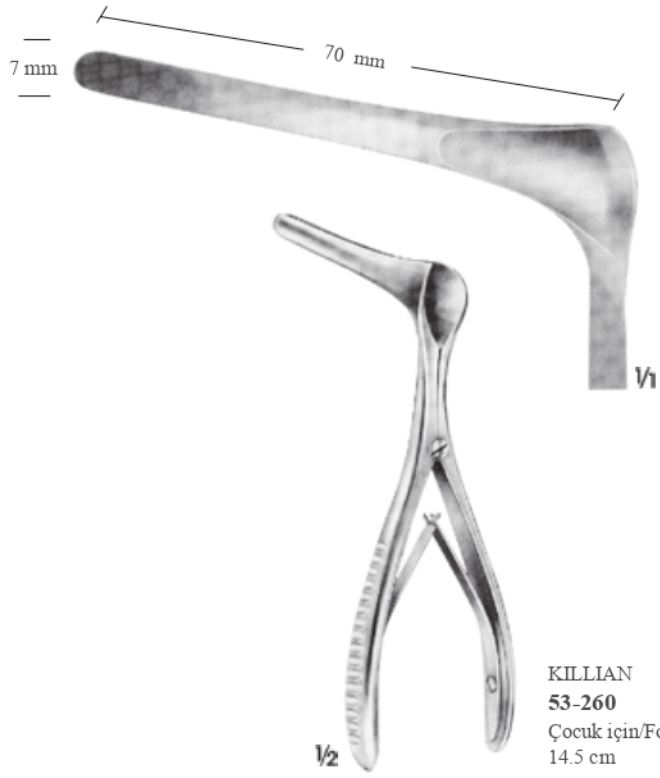

**KILLIAN**  
**53-260**  
Çocuk için/For children  
14.5 cm

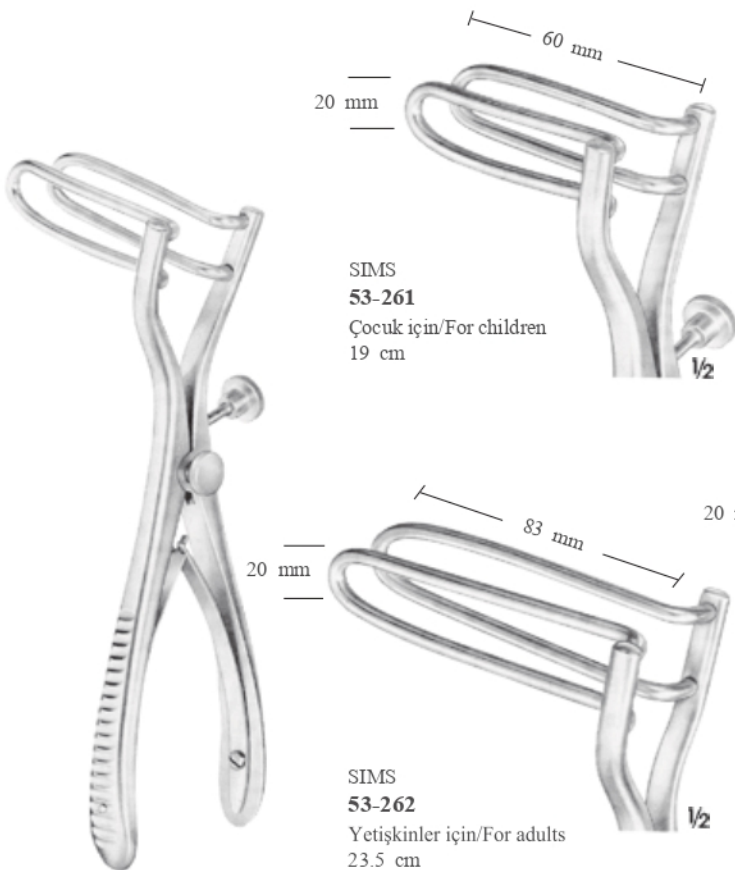

**SIMS**  
**53-261**  
Çocuk için/For children  
19 cm

**SIMS**  
**53-262**  
Yetişkinler için/For adults  
23.5 cm

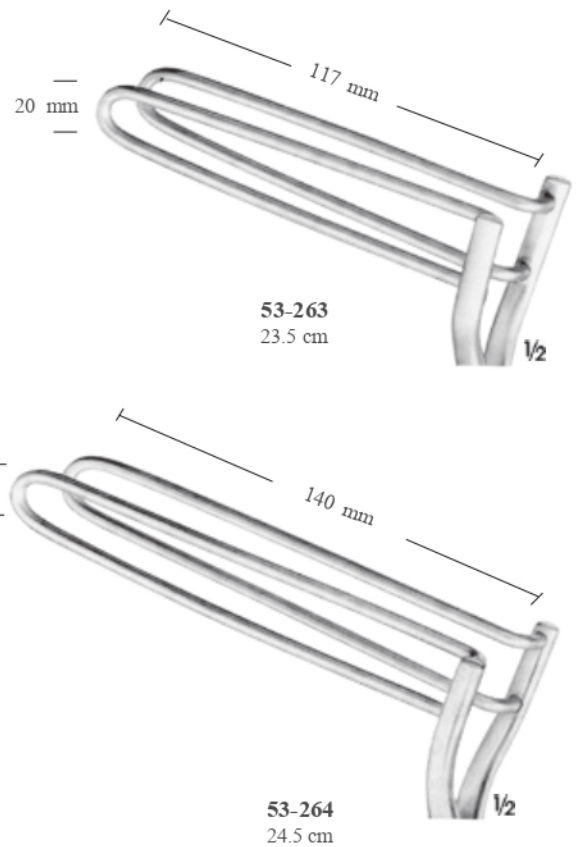

**53-263**  
23.5 cm

**53-264**  
24.5 cm



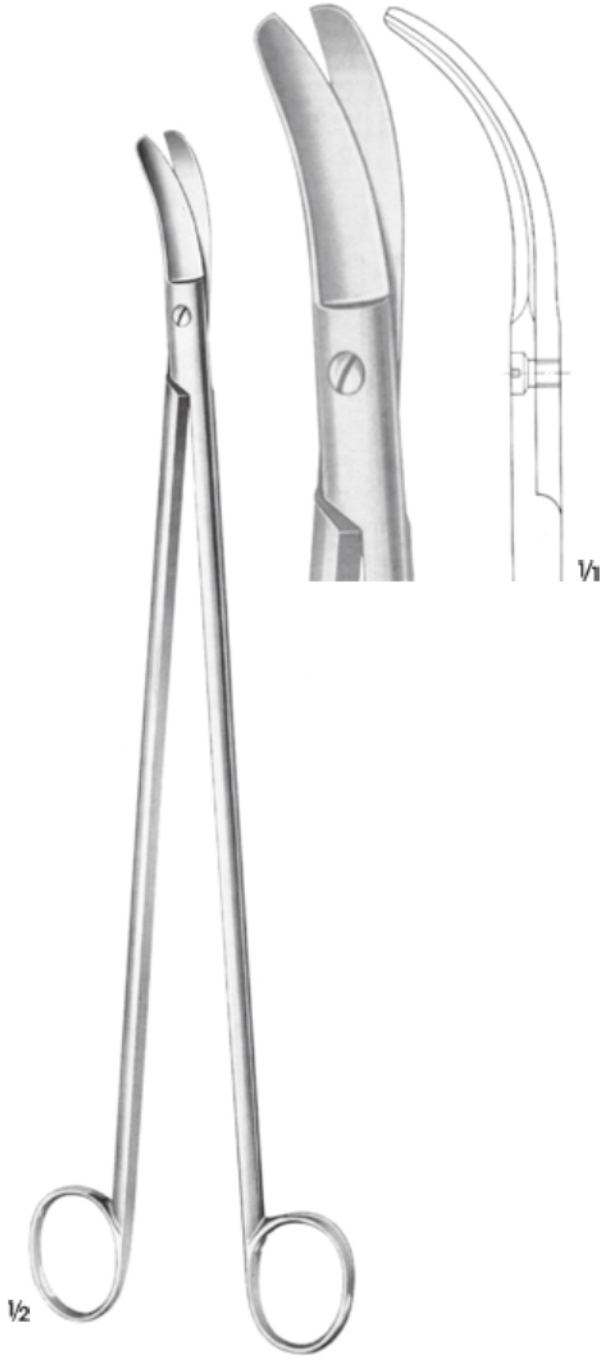

**53-265**  
Rektal makas  
Rectal scissors  
32.5 cm

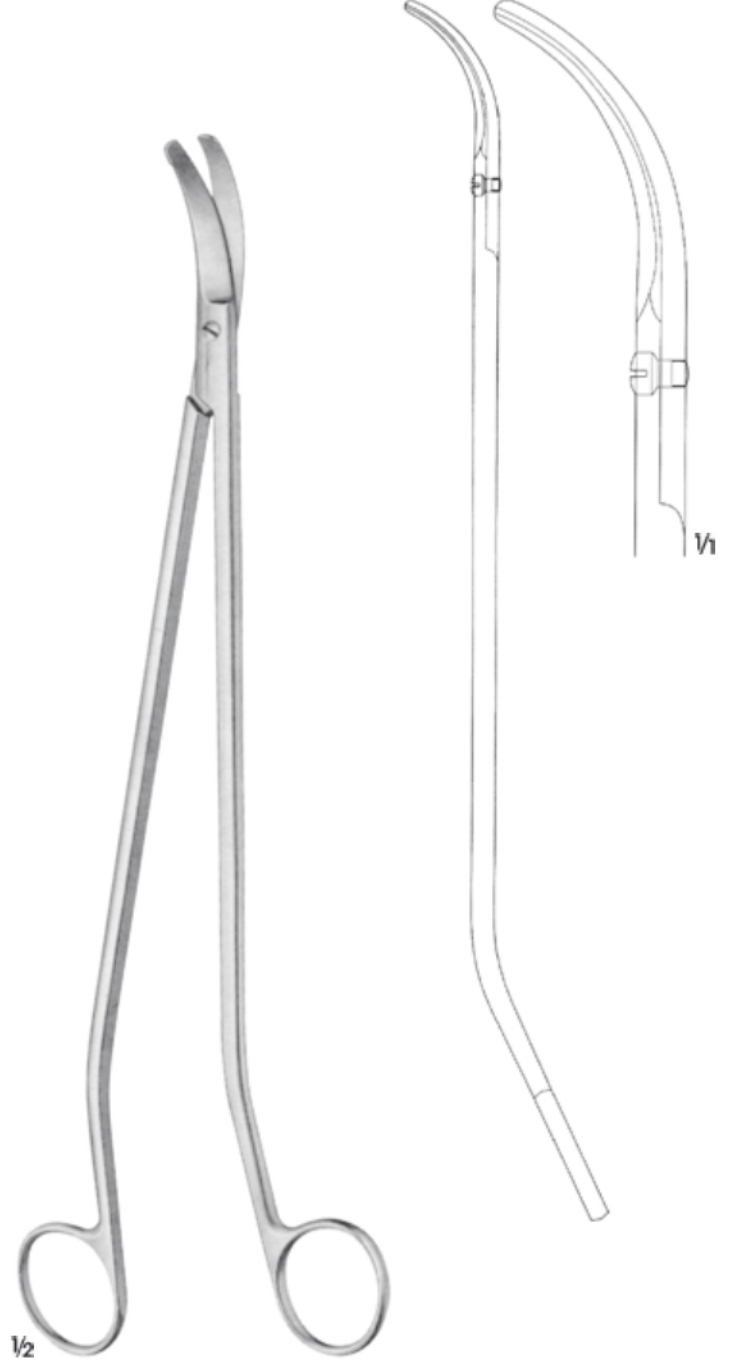

**MÜLLER**  
**53-266**  
Rektum makas s şekli  
Rectum scissors s-shaped  
32.5 cm



**ALLIS**  
**53-267**  
Tutma pensi  
Grasping forceps  
29.5 cm

Atromatik  
Atraumatic



**DE BAKEY**  
**53-268**  
35 cm

HardTips



**MÜLLER**  
**53-269**  
Portegü/Needle holder  
36 cm









PAYR  
53-272  
Çocuklar için bağırsak klemp  
Intestinal clamp light pattern,  
for children  
18 cm

PAYR  
53-273  
20 cm

PAYR  
53-274  
27.5 cm

PAYR  
53-275  
Pilor Klemp  
Pylorus clamp  
31.5 cm



KOCHER  
Soft and elastic

Yumuşak ve elastik

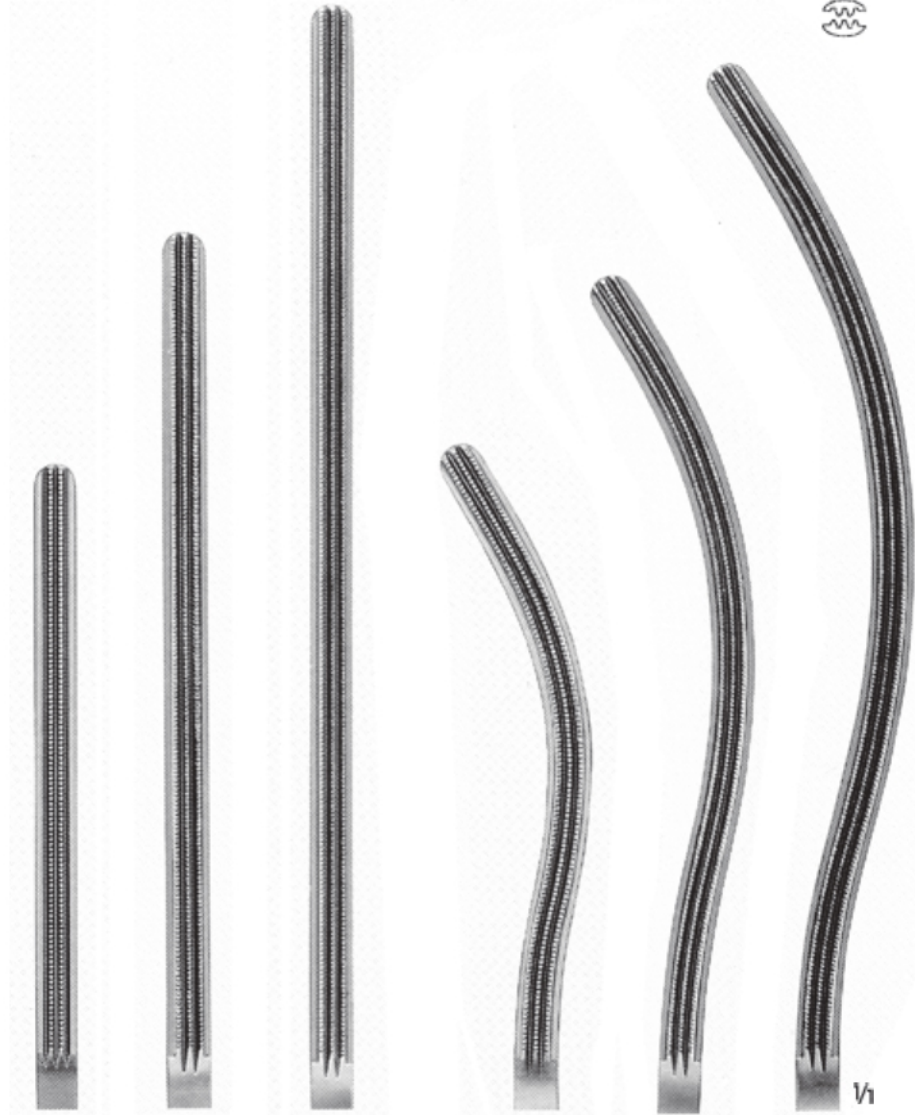

**53-276**

Düz/Straight  
22 cm

**53-277**

Düz/Straight  
25 cm

**53-278**

Düz/Straight  
28 cm

**53-279**

Eğri/Curved  
22 cm

**53-280**

Eğri/Curved  
25 cm

**53-281**

Eğri/Curved  
28 cm



KOCHER  
Soft and elastic

Yumuşak ve elastik

**53-282**  
Düz/Straight  
22 cm



**53-283**  
Düz/Straight  
25 cm



**53-284**  
Düz/Straight  
28 cm



**53-285**  
Eğri/Curved  
22 cm



**53-286**  
Eğri/Curved  
25 cm



**53-287**  
Eğri/Curved  
28 cm





Atromatik  
Atraumatic

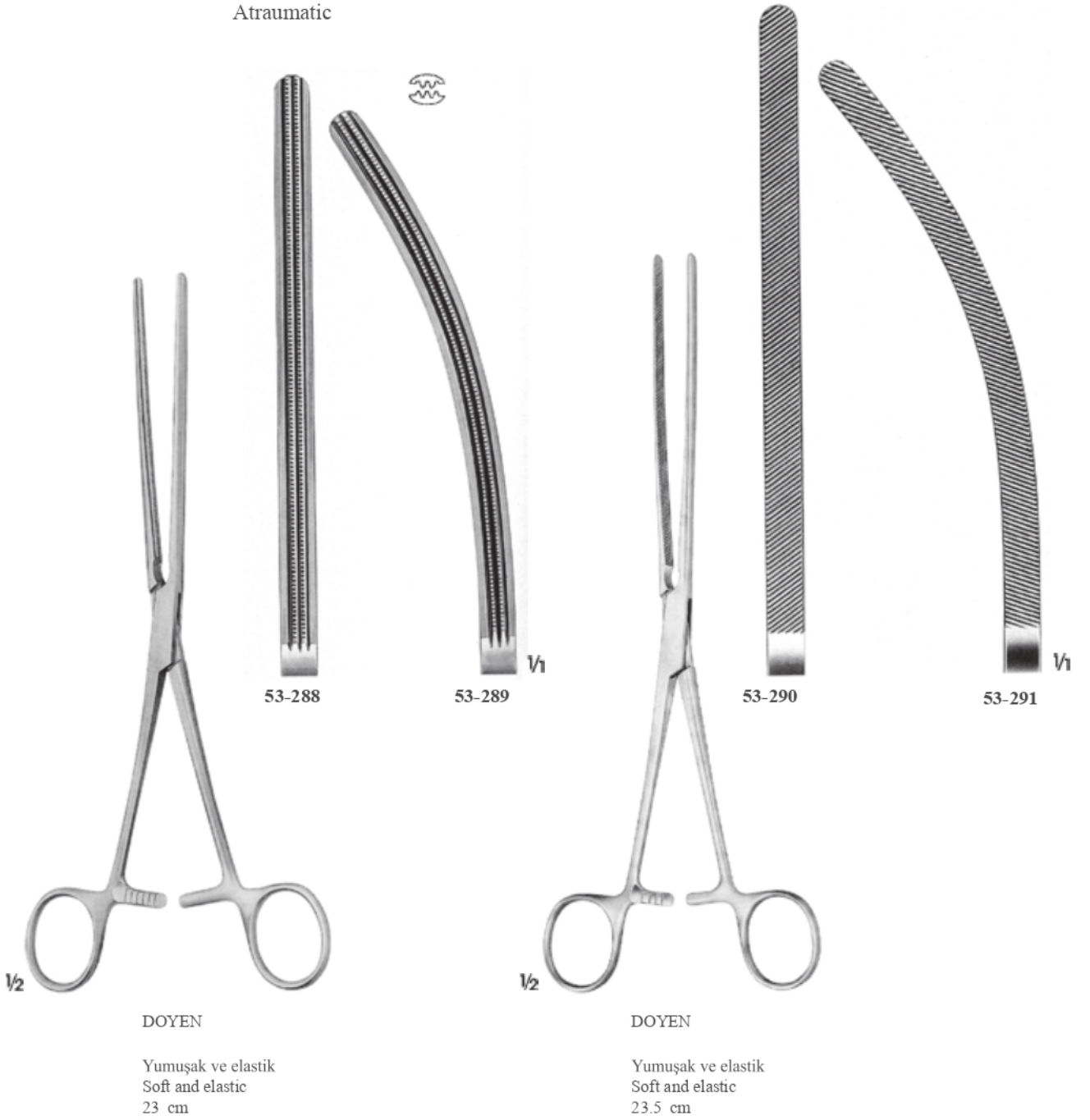

53-288

53-289

53-290

53-291

1/2

DOYEN

Yumuşak ve elastik  
Soft and elastic  
23 cm

1/2

DOYEN

Yumuşak ve elastik  
Soft and elastic  
23.5 cm





KOCHER  
Soft and elastic

Yumuşak ve elastik

53-292  
21 cm



53-293  
23 cm



53-294  
21 cm



53-295  
23 cm

$\frac{1}{1}$



53-296



53-297

$\frac{1}{1}$

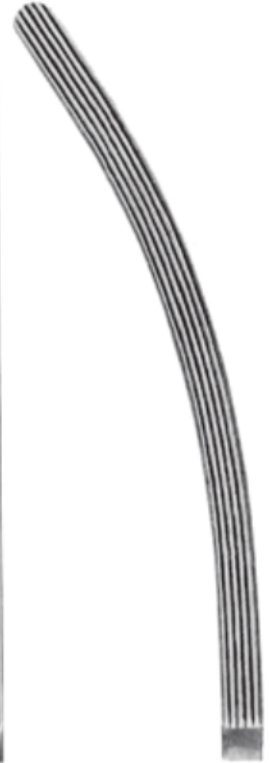

$\frac{1}{2}$

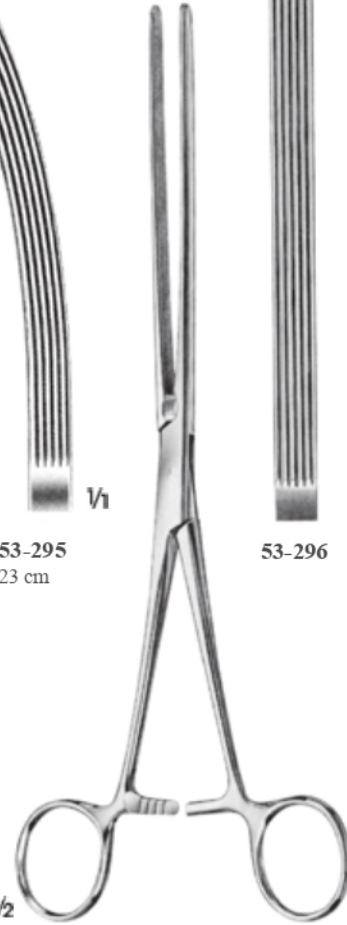

DOYEN

Yumuşak ve elastik  
Soft and elastic  
24 cm



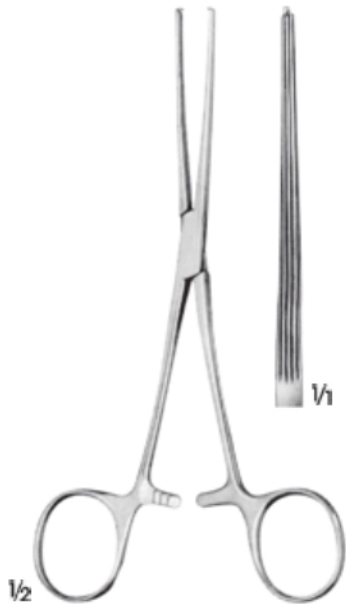

ALLEN  
53-298  
15.5 cm

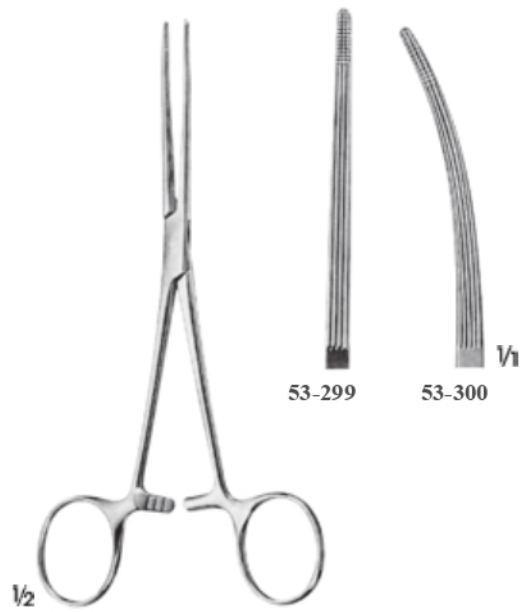

BAINBRIDGE  
15.5 cm



DOYEN  
Elastik/Elastic  
16.5 cm

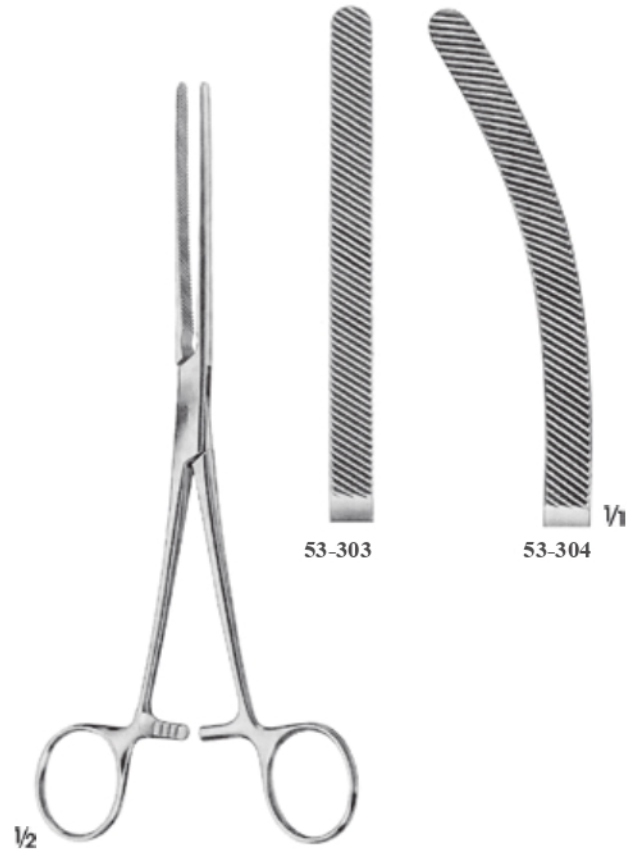

HARTMANN  
Yumuşak ve elastik  
20 cm



**BABY-KOCHER**  
Çocuklar için/For children Çok elastik/Very elastic 13 cm

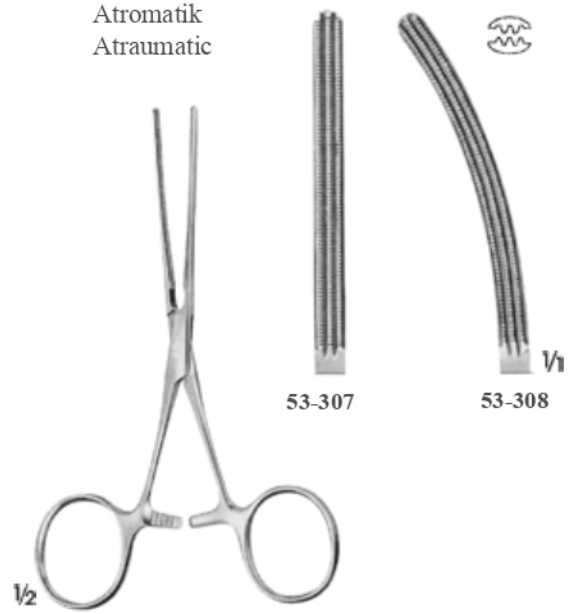

**BABY-KOCHER**  
Çocuklar için/For children

Yumuşak ve elastik/ Soft and elastic

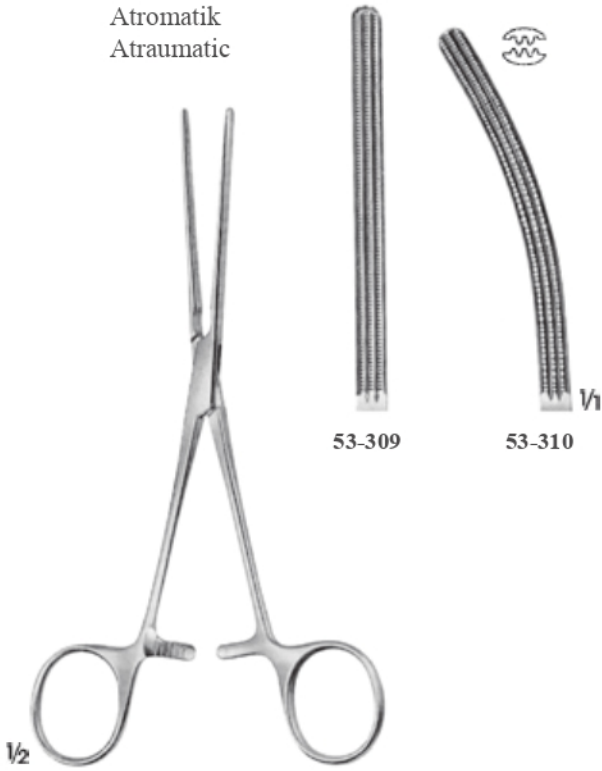

**DOYEN**

Yumuşak ve elastik  
Soft and elastic  
17 cm

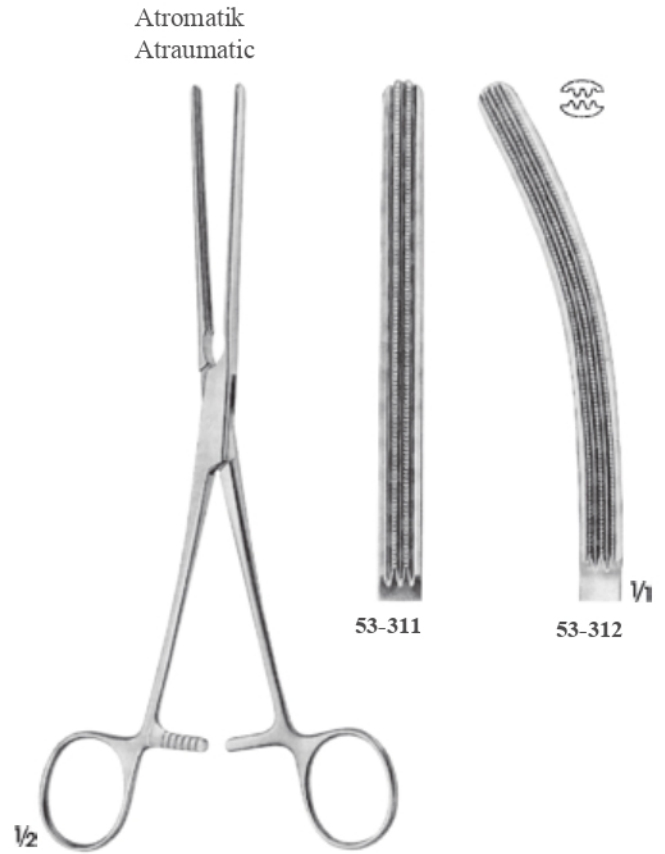

**HARTMANN**

Yumuşak ve elastik  
20 cm





1/2

MAYNIHAN  
53-313  
28 cm



1/1

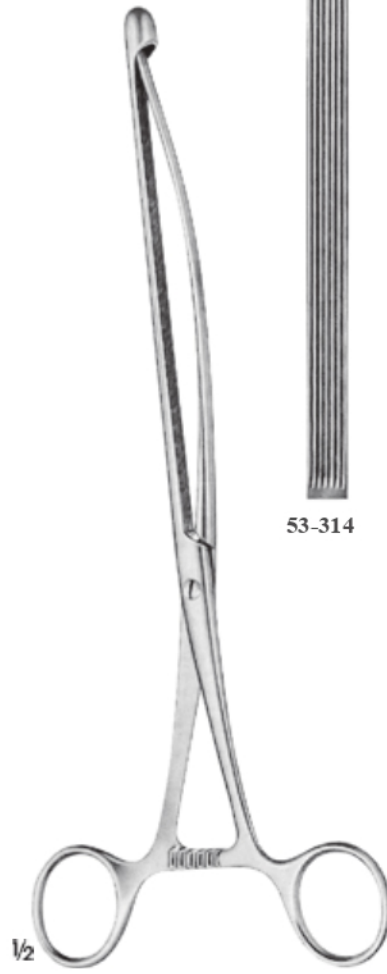

1/2

NUSSBAUM

Yumuşak ve elastik  
Soft and elastic  
25 cm



53-314

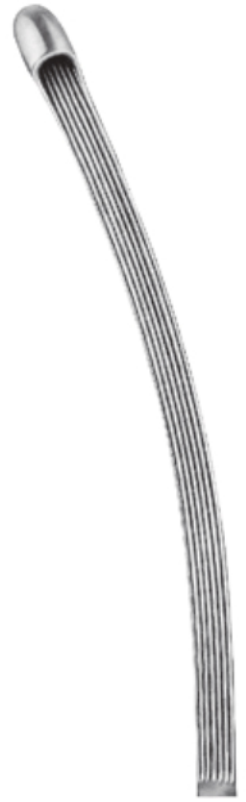

53-315

1/1

Atromatik  
Atraumatic







**SCHOEMAKER**  
**53-320**  
Kolektomi klempi  
Colectomy clamp  
20 cm



**LANG-STEVENSON**  
**53-321**  
Bağırsak klempi  
Intestinal clamp  
20 cm



**SCUDDER**  
**53-322**  
Mide klempi  
Stomach clamp  
33 cm

Atromatik  
Atraumatic





**BENSON**  
**53-323**  
Pilor ayırıcı  
Pylorus spreader  
15.5 cm



**KLEINSCHMIDT**  
**53-324**  
Apendektomi klempli  
Appendectomy clamp  
13 cm



**DE MARTEL-WOLFSON**  
**53-325** 10 cm  
**53-326** 12 cm  
Anastomoz klempli, 3'lü set  
Anastomosis clamps,  
set of 3



**53-327** 22.5 cm  
Klempli tutucusu  
Clamp holder



Sert Klempli tutucu  
Clamp holder with set of clamps

**53-328** 8 cm  
Klempli tutucusu  
Clamp holder



**DE MARTEL-WOLFSON**  
**53-329**  
Kapama pensu  
Closing forceps  
25 cm





V1

V1

Atromatik  
Atraumatic

53-331  
78 mm

53-332  
88 mm

53-333  
98 mm

V2

**PARKER-KERR**  
**53-330** Anastomoz  
pensi, kolon rezeksiyonu  
için Anastomosis  
forceps for colon  
resection  
25 cm

**DICK**  
**53-331** 25.5 cm  
**53-332** 26.5 cm  
**53-333** 27.5 cm  
Güçlü klempler  
Pressure clamps



BRUNNER  
53-334  
24.5 cm

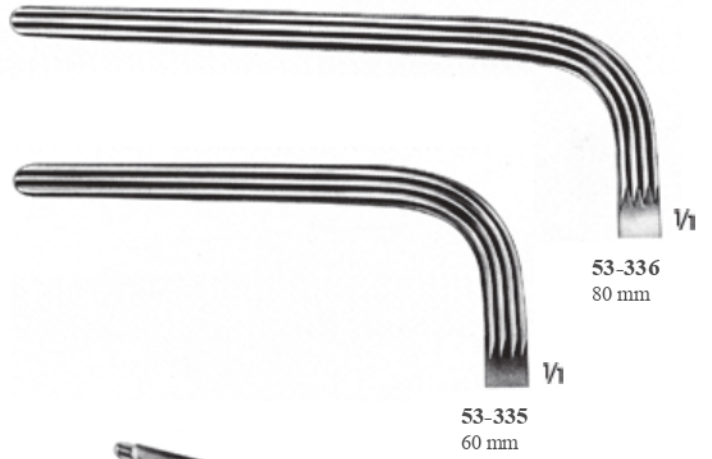

23 cm





LLOYD-DAVIS  
53-337  
31.5 cm



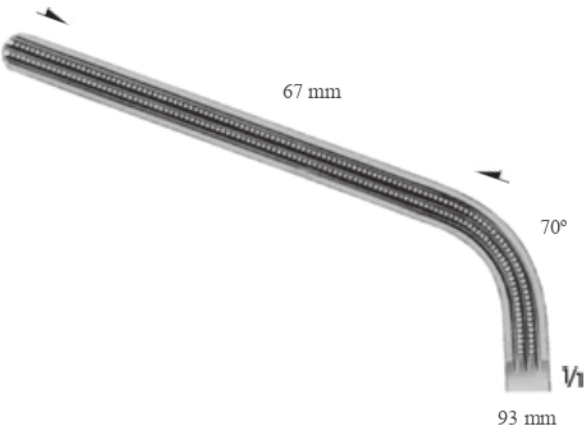

MORRIS  
53-338  
17.5 cm

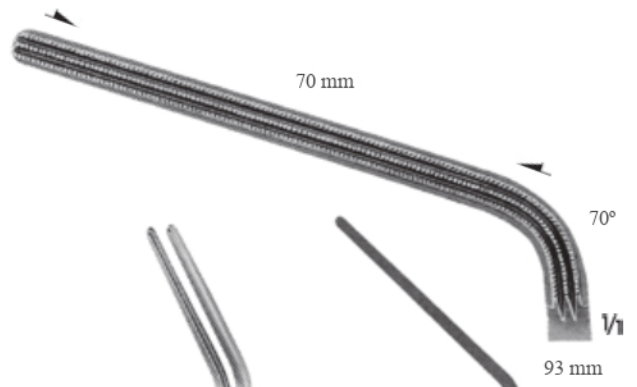

DE BAKEY (MORRIS)  
53-339  
24 cm



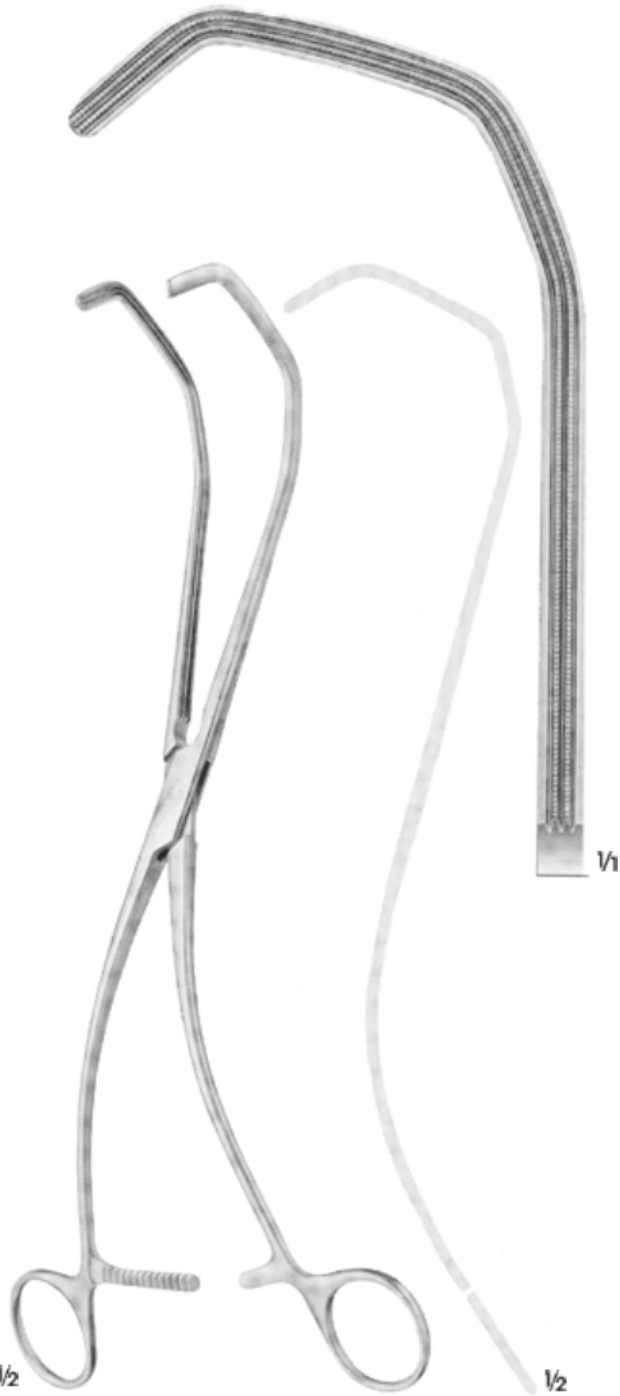

KERSTING  
53-340  
30 cm



RESONE  
53-341  
Yumuşak/Elastic  
26.5 cm

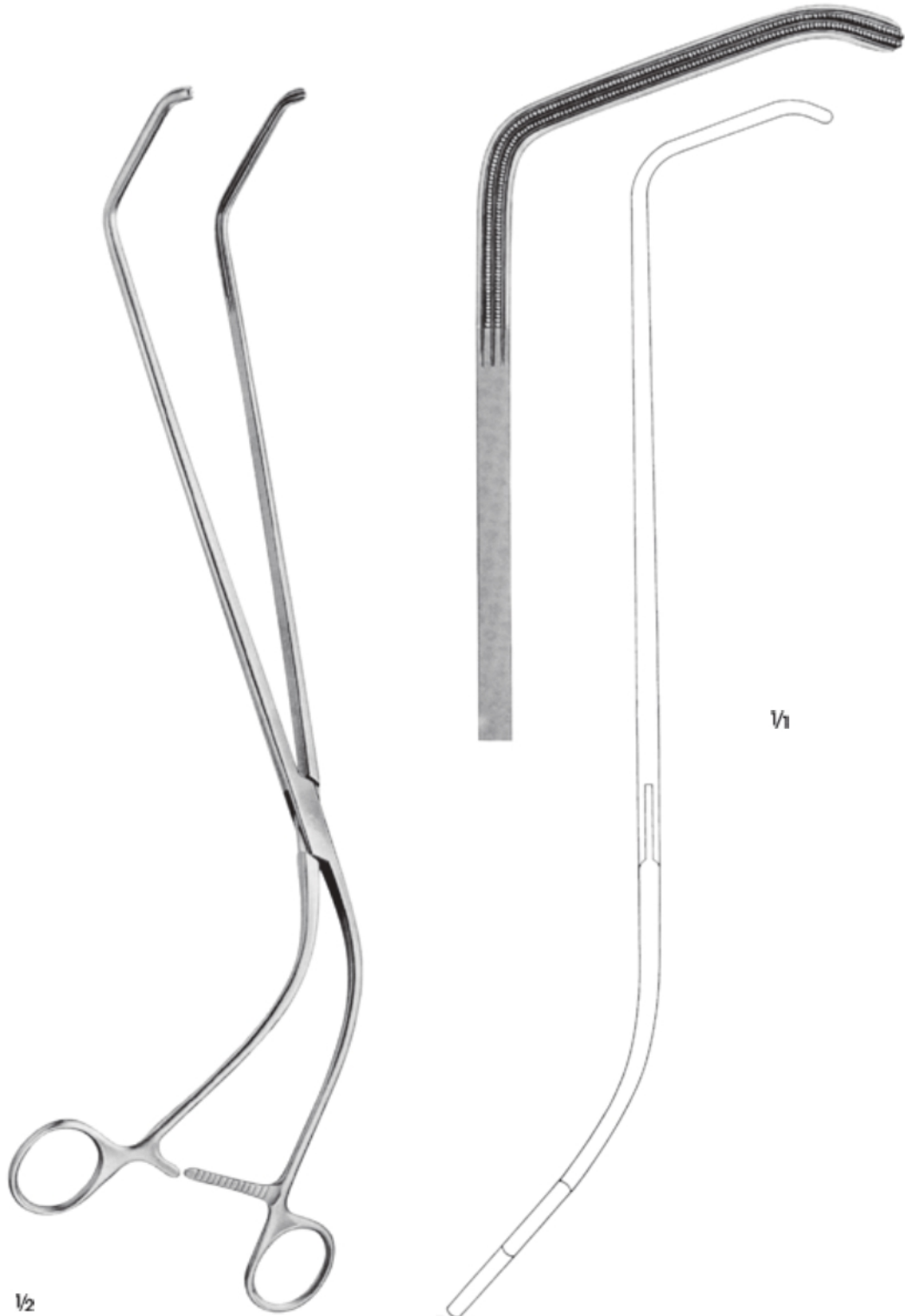

1/2

1/1

MULLER  
53-342  
Rektal anastomoz klemp  
Rectal anastomosis clamp  
37.5 cm

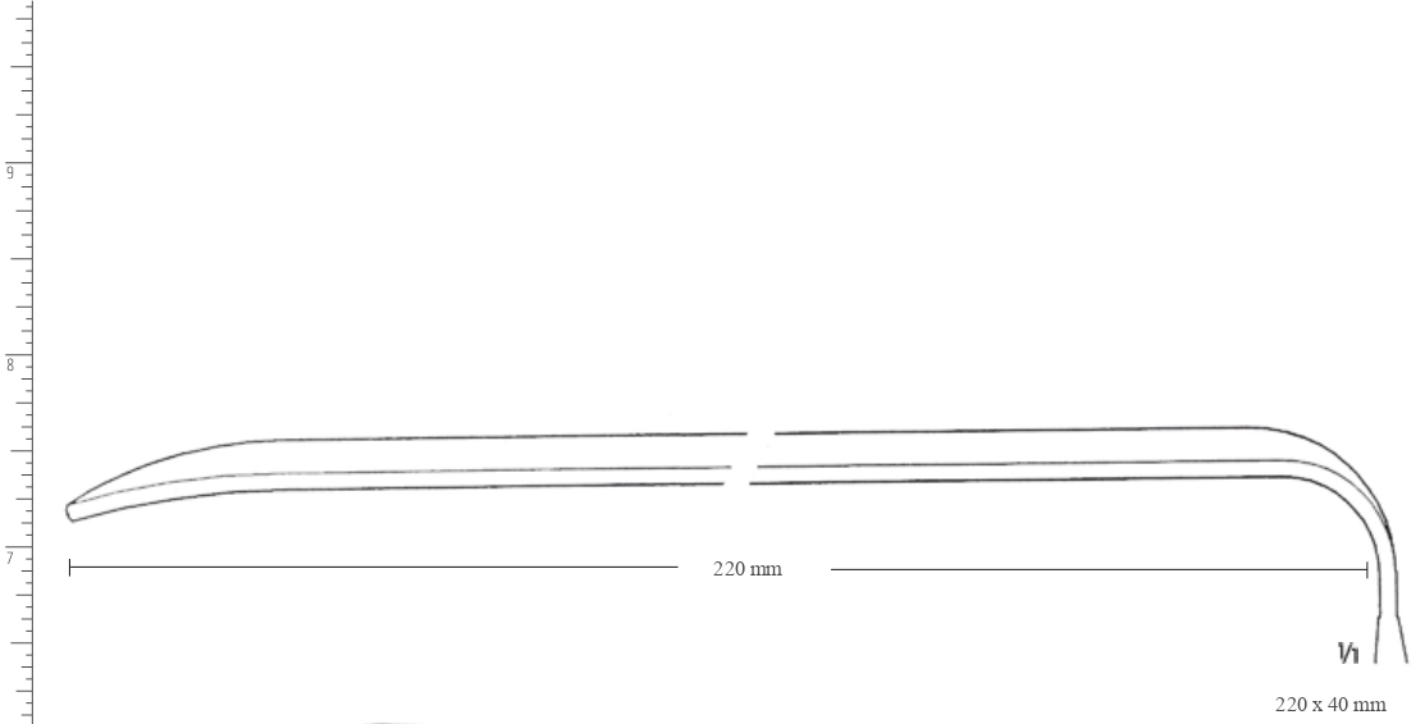

1/2  
HÖSEL  
53-343  
Ekartör /Retractor  
25 cm

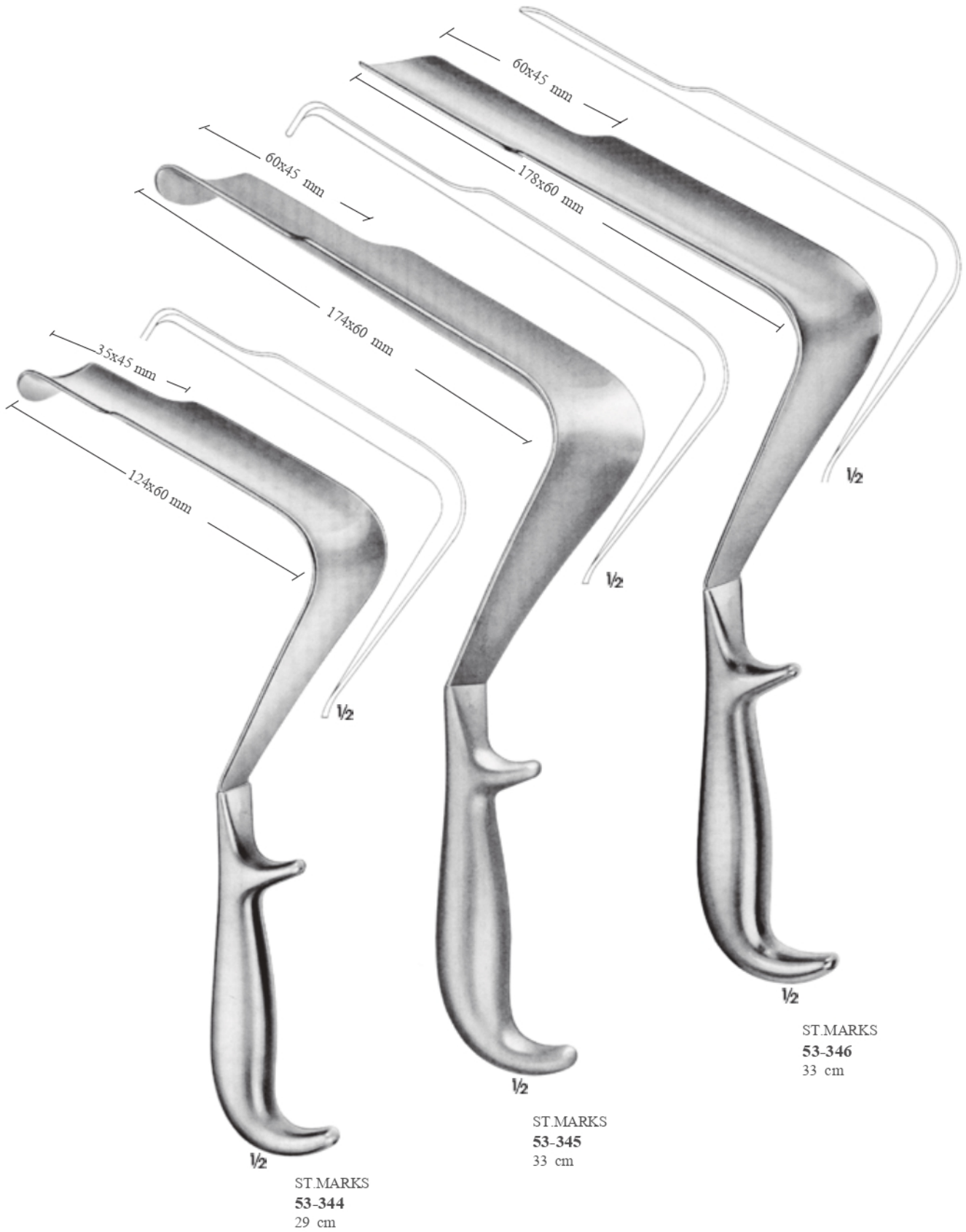



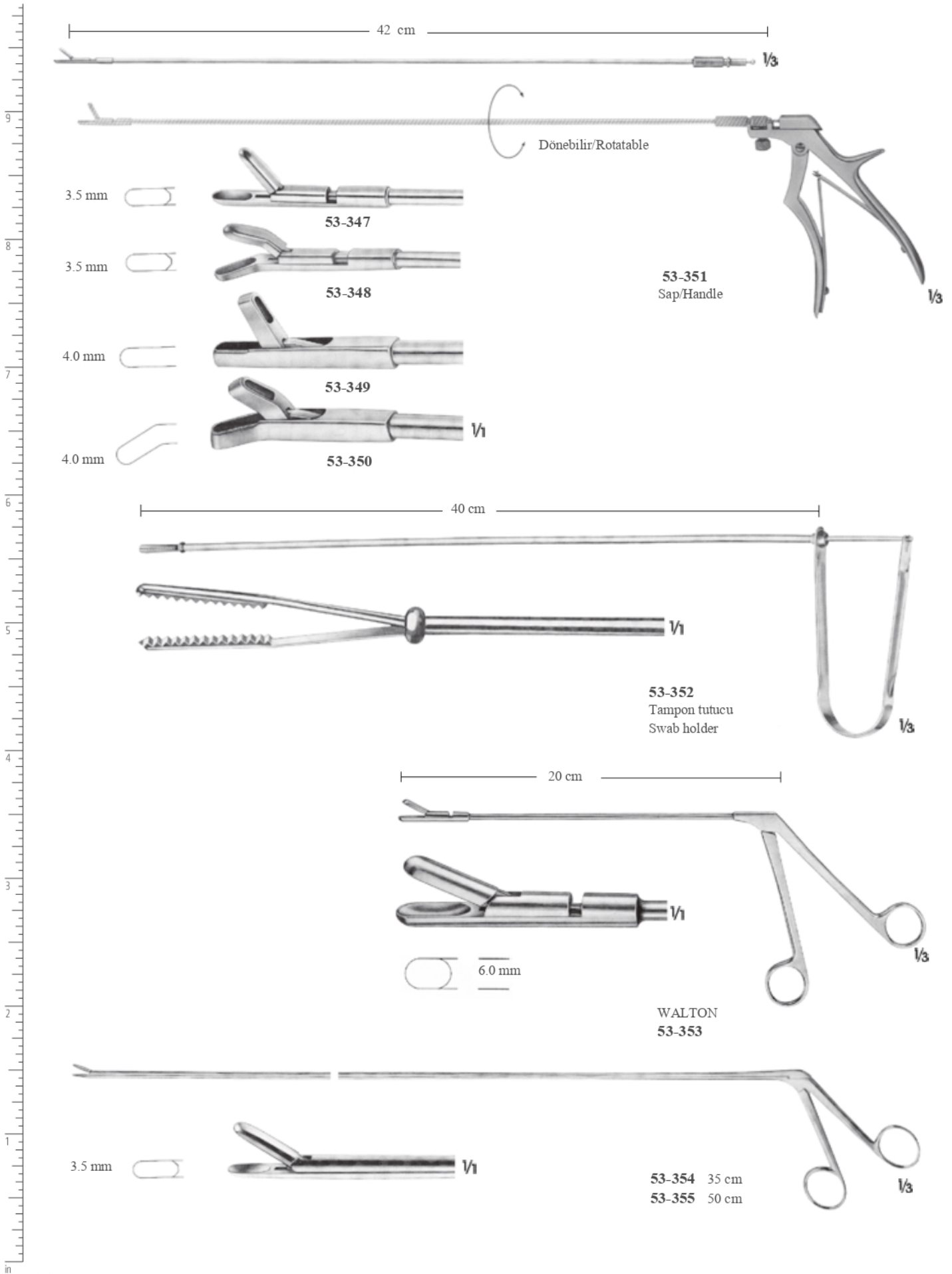

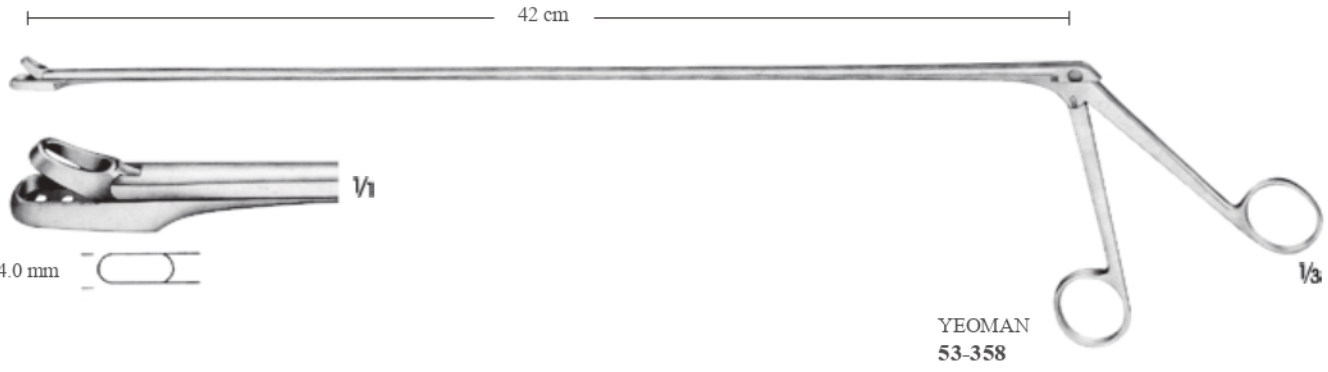
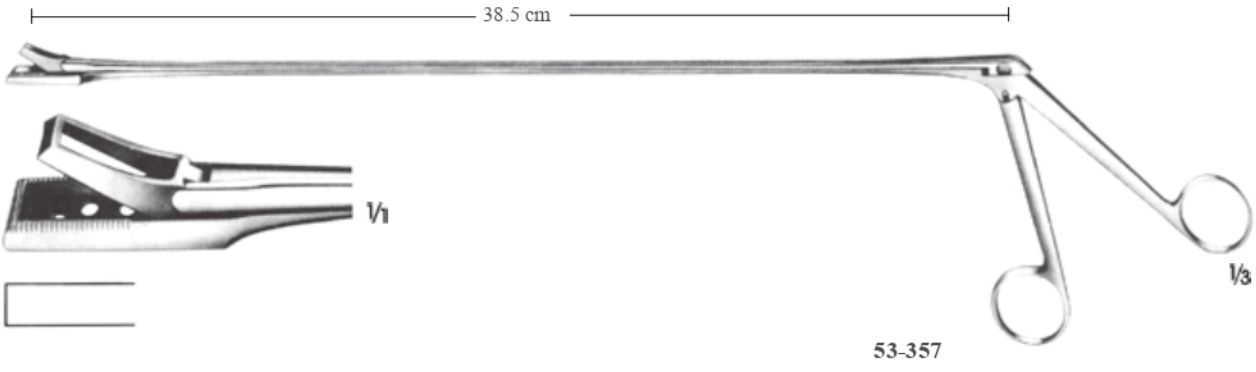
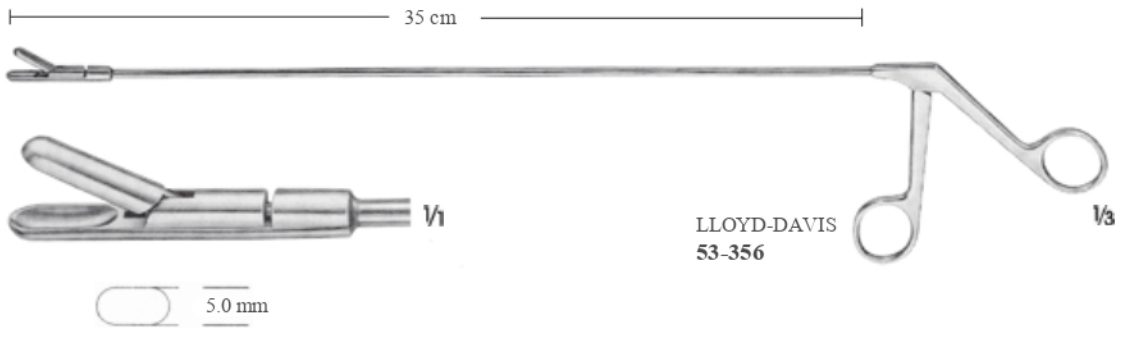



53-359

53-360



53-361

53-362



53-363  
24 cm



1/2

53-364  
22.5 cm

DESJARDINS  
22.5 cm



DESJARDINS  
Hassas model  
Extremely delicate patterns

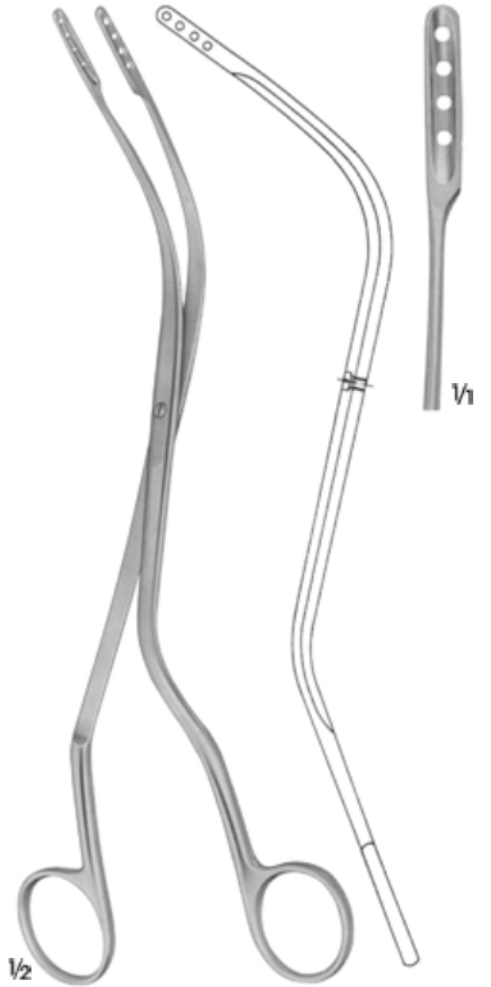

1/2

TÜBINGER  
53-365  
25.5 cm

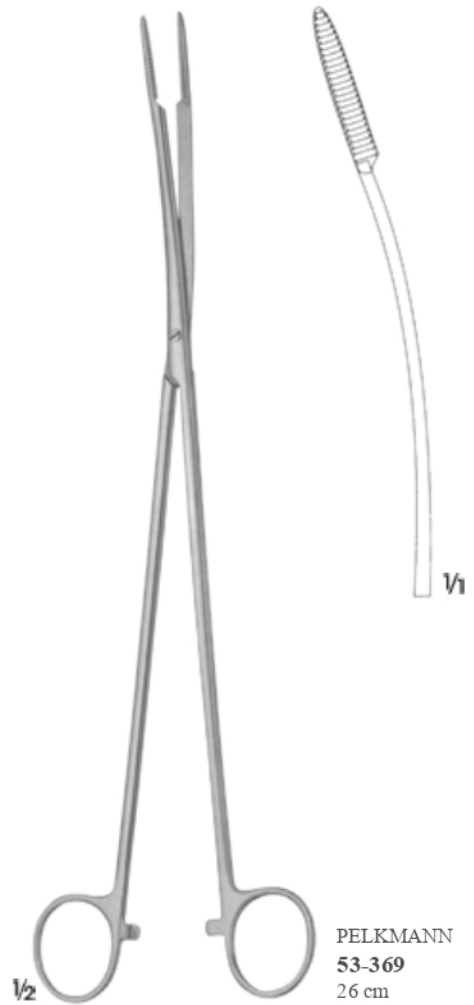
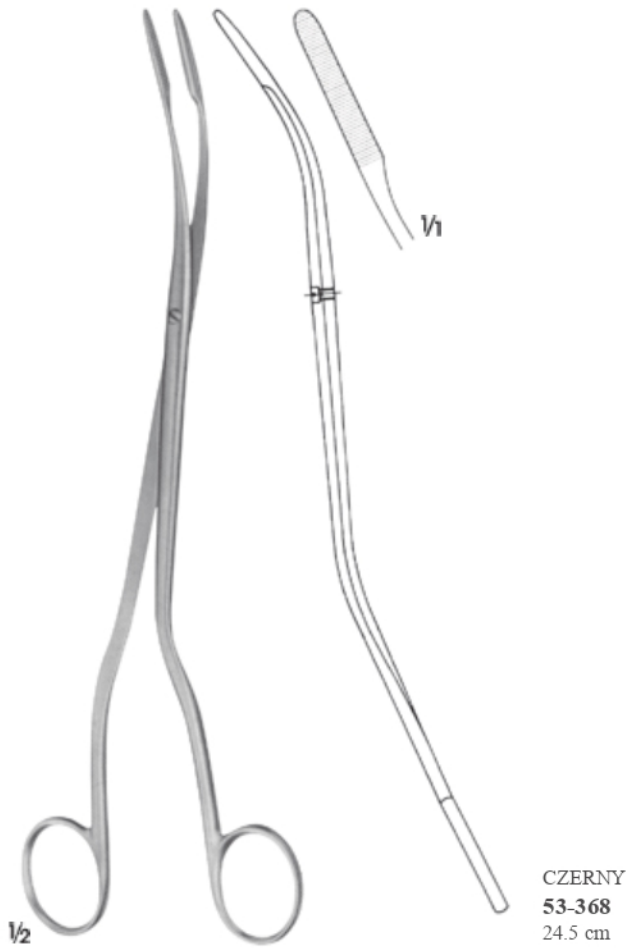
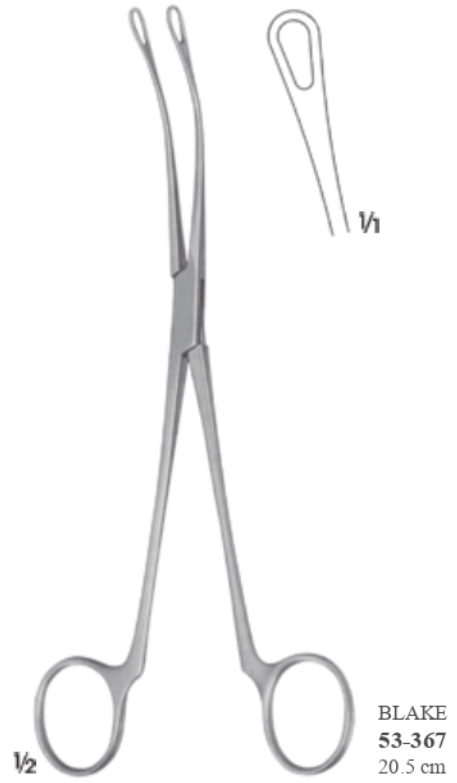



1/2

HABERER  
53-370  
36 cm



1/1



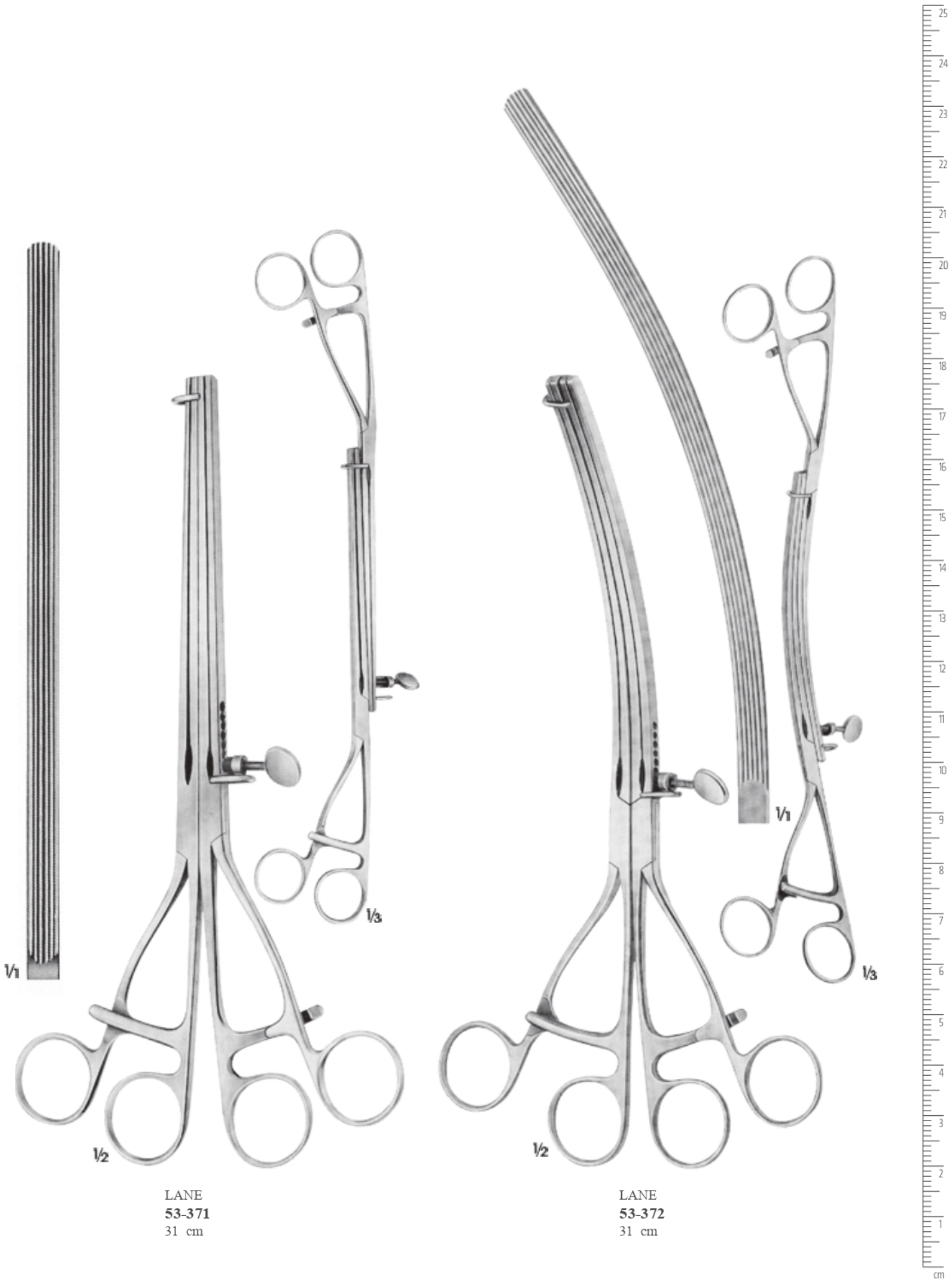

LANE  
53-371  
31 cm

LANE  
53-372  
31 cm



# ASCLASS

ASCLASS CERRAHİ ALETLER İMALAT SAN. VE TİC. LTD.ŞTİ

 [asclasscerrahialetler.ve.medya](https://www.instagram.com/asclasscerrahialetler.ve.medya)  [Asclass cerrahi aletler](https://www.facebook.com/Asclass.cerrahi.aletler)  [www.asclassgrup.com](http://www.asclassgrup.com)  [info@asclassgrup.com](mailto:info@asclassgrup.com) - [asclassmedya@gmail.com](mailto:asclassmedya@gmail.com)

 Çatalarmut Mahallesi Sezgin Sokak No:7 Kat:1/2/3 İlkadım/SAMSUN