



# ASCLASS

ASCLASS CERRAHİ ALETLER İMALAT SAN. VE TİC. LTD.ŞTİ

📍 Çatalarmut Mahallesi Sezgin Sokak No:7 Kat:1/2/3 İlkadım/SAMSUN

📱 asclasscerrahialetler.ve.medya 🌐 Asclass cerrahi aletler 🌐 www.asclassgrup.com 📧 info@asclassgrup.com - asclassmedya@gmail.com

# ÜRÜN GRUPLARIMIZ

- » Genel Cerrahi
- » Beyin Cerrahi
- » Ortopedi Cerrahi
- » Göz Cerrahi
- » Kulak Burun Boğaz
- » Jinekoloji
- » Üroloji
- » Kalp Damar
- » Üniversal Ekartör Setleri
- » Laparoskopik Ekartör Setleri
- » Laparoskopik El Aletleri
- » Steril Konteynir Sistem

**50**

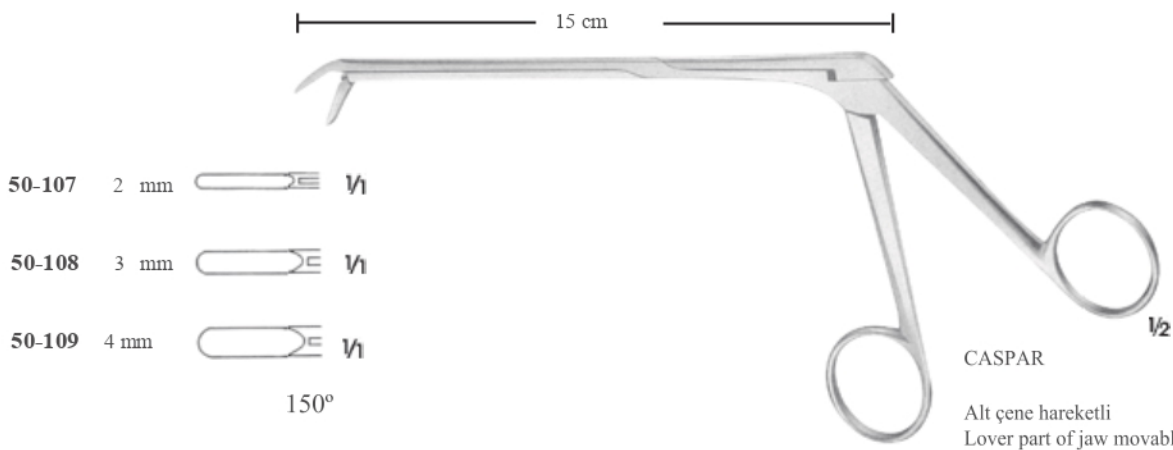
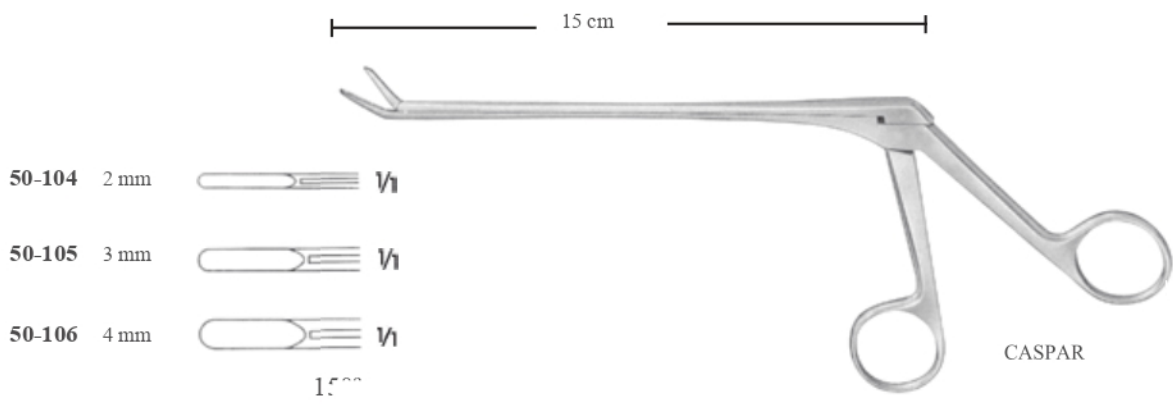
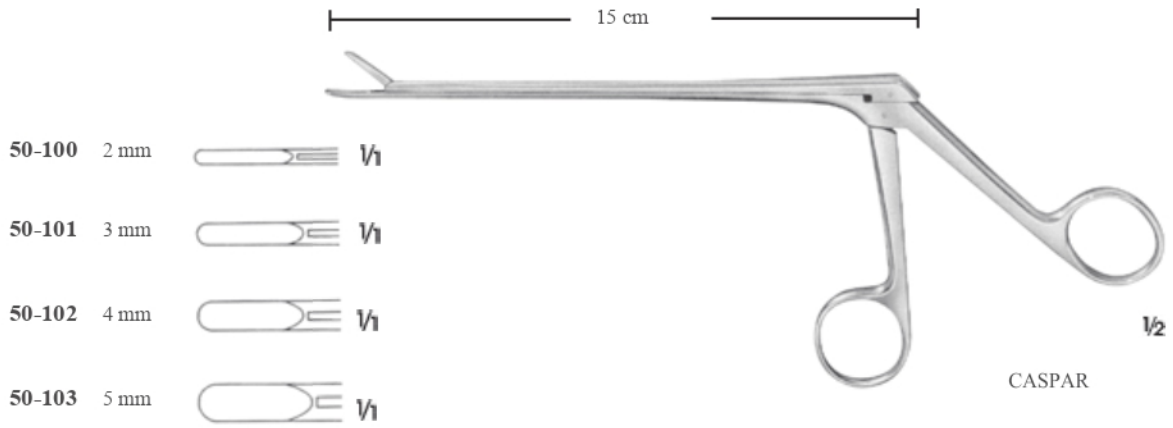



CUSHING

50-110 4 mm



V1

50-111 5 mm



V1

50-112 6 mm



V1

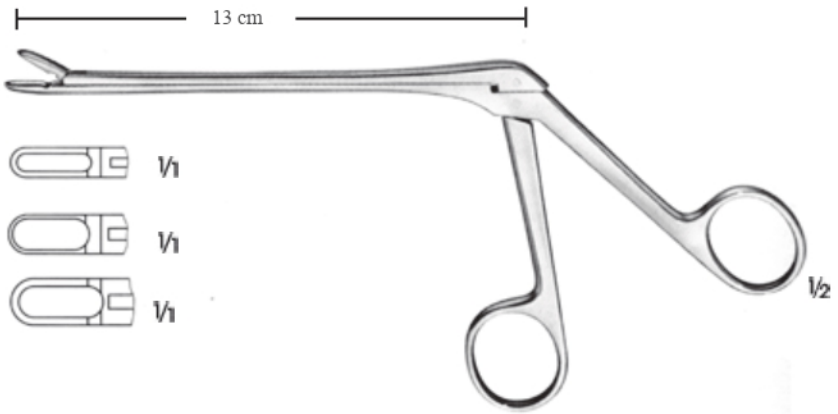

CUSHING

50-113 3 mm



V1

50-114 4 mm



V1

50-115 5 mm



V1

150°

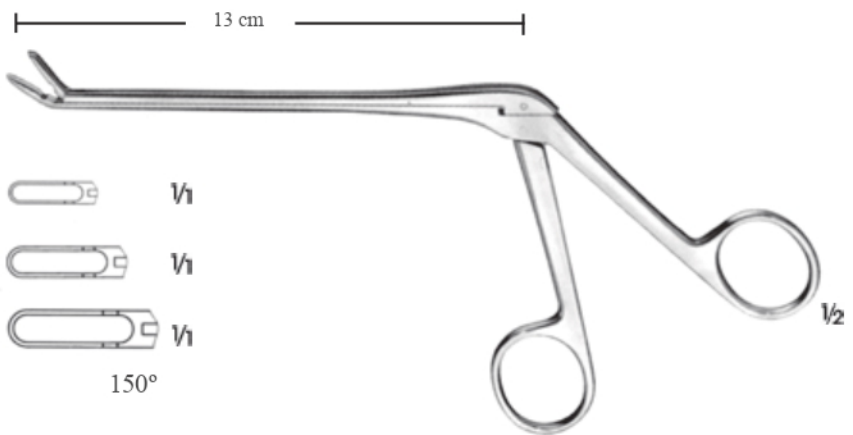

CUSHING

50-116 3 mm



V1

50-117 4 mm



V1

150°

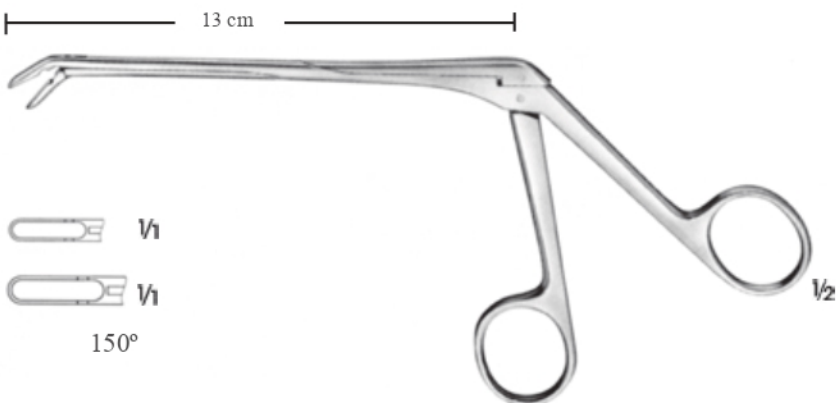

LOVE-GRUENWALD  
50-118 2 x 10 mm



LOVE-GRUENWALD  
50-119 3 x 10 mm



SPURLING  
50-120 4 x 10 mm



CUSHING  
50-121 2 x 10 mm



LOVE-GRUENWALD  
50-122 3 x 10 mm

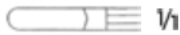

SPURLING  
50-123 4 x 10 mm



LOVE-GRUENWALD  
50-124 3 x 10 mm



SPURLING  
50-125 4 x 10 mm



150°



Üst çene hareketli  
Upper part of jaw movable

LOVE-GRUENWALD  
50-126 3 x 10 mm



LOVE-GRUENWALD  
50-127 4 x 10 mm



150°

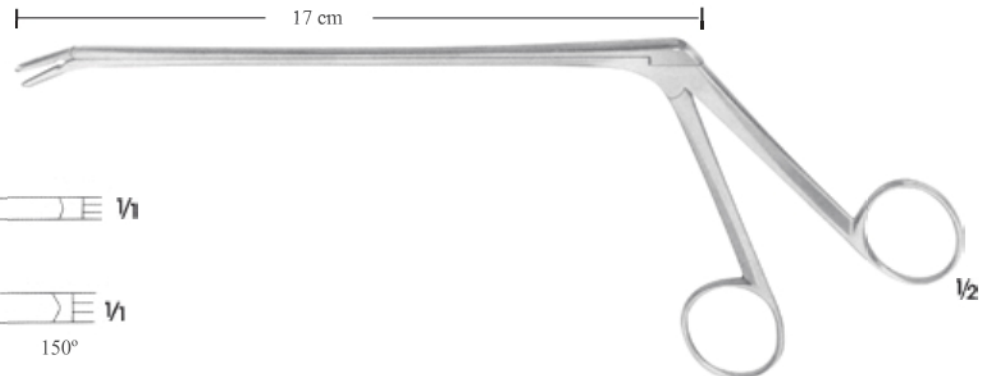

Alt çene hareketli  
Upper part of jaw movable

Mil uzunluğu  
Length of shaft  
14 cm

50-128

Mil uzunluğu  
Length of shaft  
16 cm

50-130

Mil uzunluğu  
Length of shaft  
18.5 cm

50-133

Çene Ölçüleri  
Size of jaws

3 x 12 mm



50-129

50-131

50-134

4 x 14 mm



150°

CASPAR

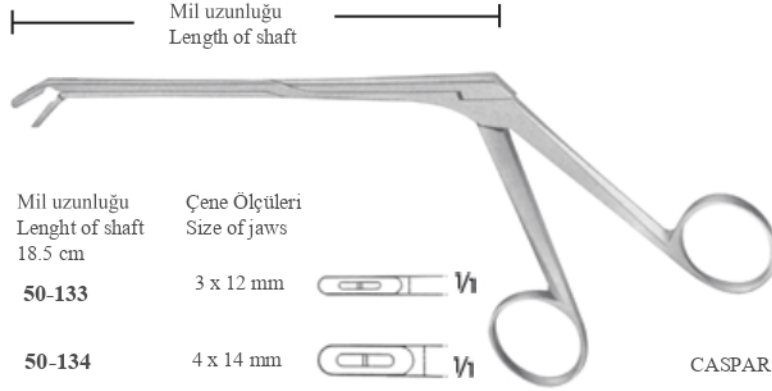

Mil uzunluğu  
Length of shaft  
14 cm

50-135

50-136

50-137

50-138

50-139

Mil uzunluğu  
Length of shaft  
16 cm

50-140

50-141

50-142

50-143

50-144

Mil uzunluğu  
Length of shaft  
18.5 cm

50-145

50-146

50-147

50-148

50-149

Çene ölçüleri  
Size of jaws

2 x 12 mm

3 x 12 mm

4 x 14 mm

5 x 14 mm

6 x 16 mm

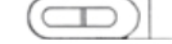

CASPAR

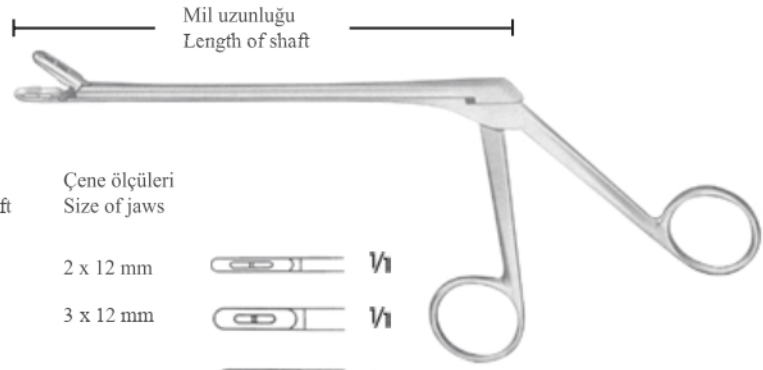

Mil uzunluğu  
Length of shaft  
14 cm

50-150

50-151

50-152

Mil uzunluğu  
Length of shaft  
16 cm

50-153

50-154

50-155

Mil uzunluğu  
Length of shaft  
18.5 cm

50-156

50-157

50-158

Çene ölçüleri  
Size of jaws

3 x 12 mm

4 x 14 mm

5 x 14 mm



150°

CASPAR

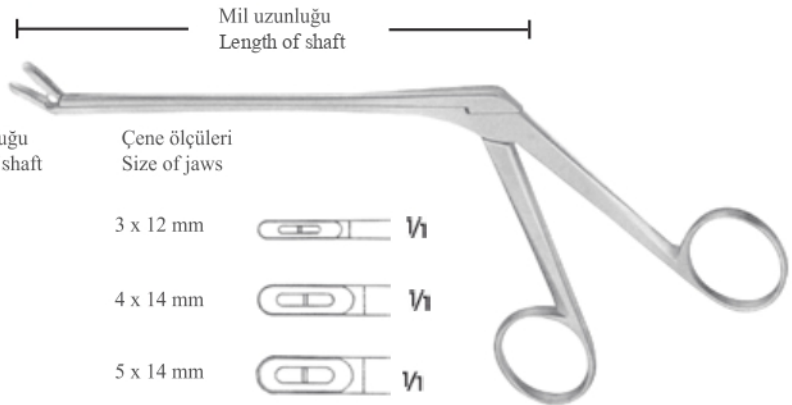



**OLDBERG**  
**50-159** Ø 7 mm

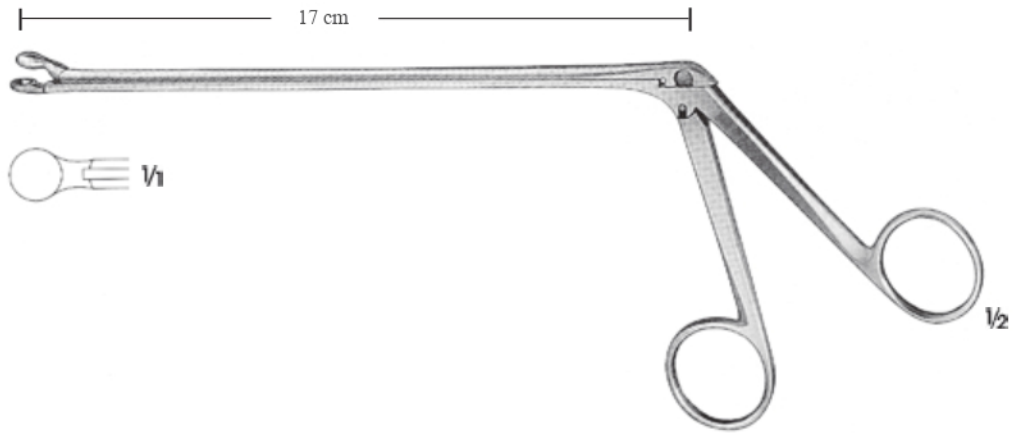

**YASARGIL**  
**50-160** Ø 2.2 mm

**50-161** Ø 3.5 mm

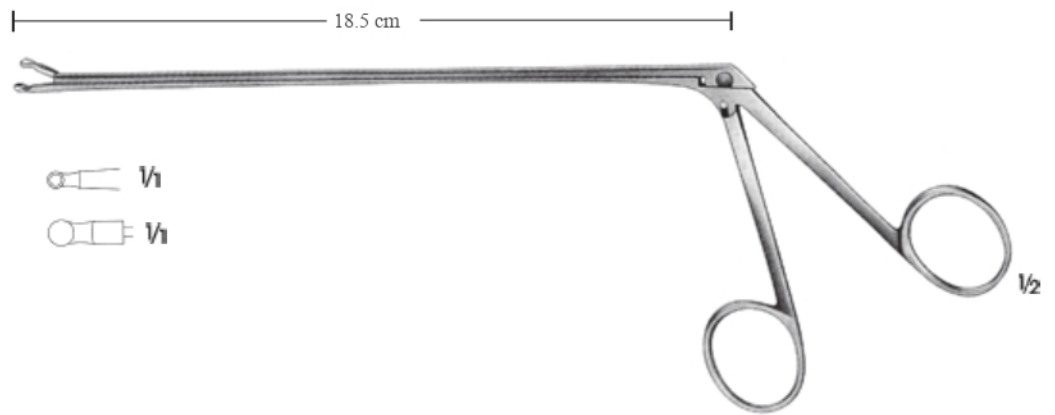

**LANDOLT**  
**50-162** Ø 9 mm Grasping  
tümör pensı, künt Tumor  
grasping forceps, blunt

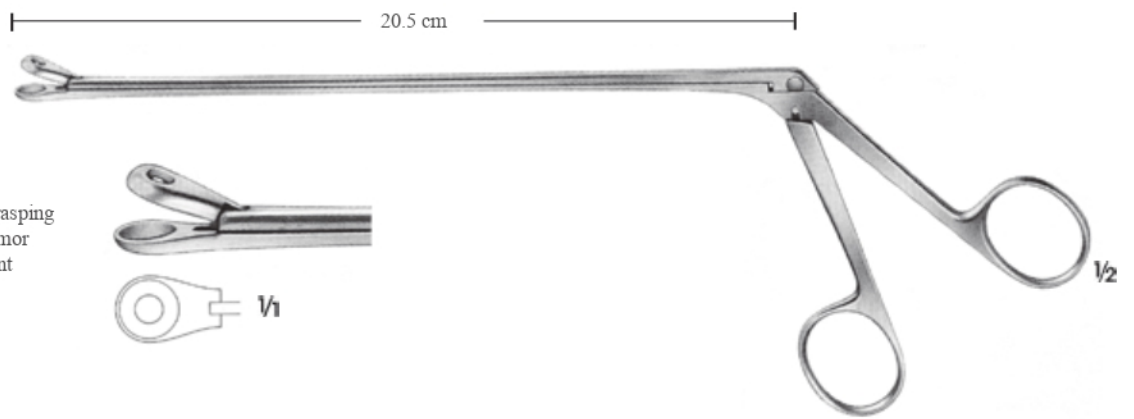

**KRAMER**  
**50-163** 2.5 x 10 mm  
Derinlik koruyuculu  
With depth guard

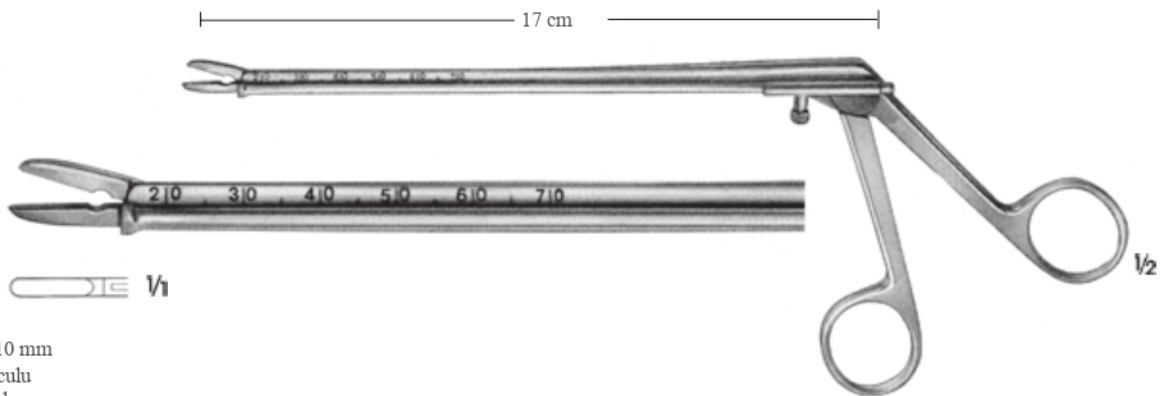



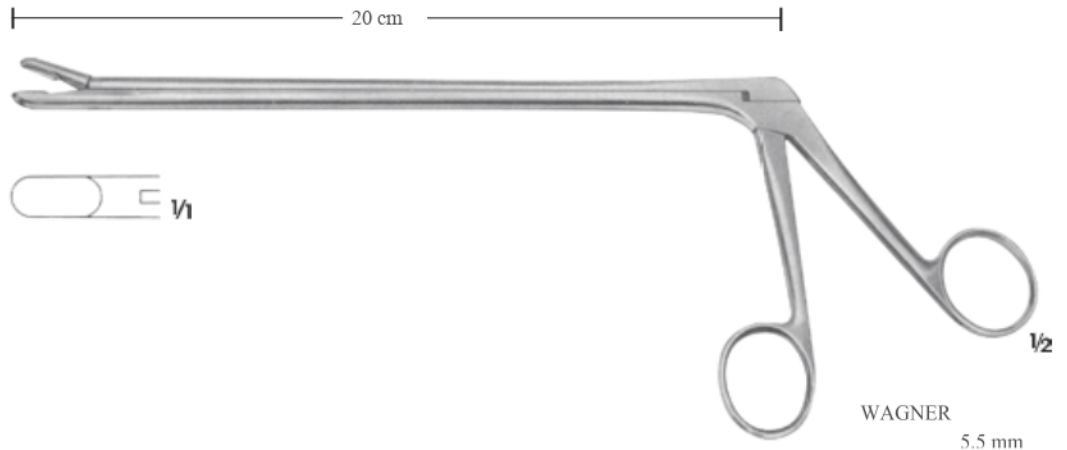

WAGNER  
5.5 mm

WAGNER  
**5.5mm**  
**50-164**

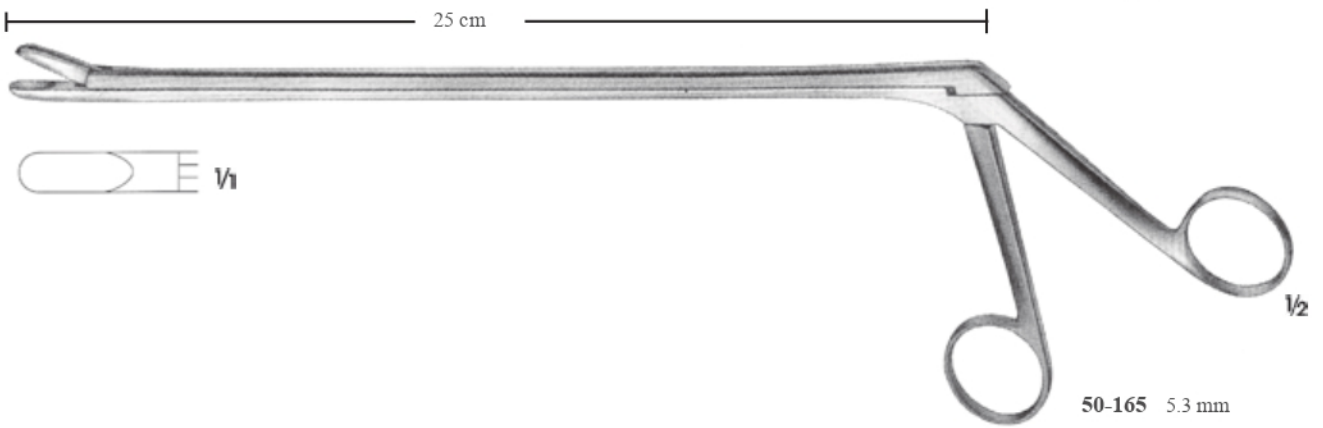

50-165 5.3 mm



SYPERT  
**50-166** 5.8 mm

90° Yukarıya doğru kesme/Upwards cutting



Standart ağız tabanlı  
Standard footplate













HardCoated















Standart ağız tabanlı  
Standard footplate



Standart ağız tabanlı  
Standard footplate

Boy Length	En Widht	Ejektör Ejector	Ayrılabilir/Detachable		Standart/Standard	
						
18 cm	1 mm		-	<b>50-167</b>	<b>50-177</b>	<b>50-187</b>
18 cm	2 mm		-	<b>50-168</b>	<b>50-178</b>	<b>50-188</b>
18 cm	3 mm		+	<b>50-169</b>	<b>50-179</b>	<b>50-189</b>
18 cm	4 mm		+	<b>50-170</b>	<b>50-180</b>	<b>50-190</b>
18 cm	5 mm		+	<b>50-171</b>	<b>50-181</b>	<b>50-191</b>
18 cm	6 mm		+	<b>50-172</b>	<b>50-182</b>	<b>50-192</b>
23 cm	2 mm		-	<b>50-173</b>	<b>50-183</b>	<b>50-193</b>
23 cm	3 mm		+	<b>50-174</b>	<b>50-184</b>	<b>50-194</b>
23 cm	4 mm		+	<b>50-175</b>	<b>50-185</b>	<b>50-195</b>
23 cm	5 mm		+	<b>50-176</b>	<b>50-186</b>	<b>50-196</b>

90° Aşağıya doğru kesme/Downwards cutting

Boy Length	En Widht	Ejektör Ejector	Ayrılabilir/Detachable		Standart/Standard	
						
18 cm	1 mm		-	<b>50-197</b>	<b>50-207</b>	
18 cm	2 mm		-	<b>50-198</b>	<b>50-208</b>	
18 cm	3 mm		+	<b>50-199</b>	<b>50-209</b>	
18 cm	4 mm		+	<b>50-200</b>	<b>50-210</b>	
18 cm	5 mm		+	<b>50-201</b>	<b>50-211</b>	
18 cm	6 mm		+	<b>50-202</b>	<b>50-212</b>	
23 cm	2 mm		-	<b>50-203</b>		
23 cm	3 mm		+	<b>50-204</b>		
23 cm	4 mm		+	<b>50-205</b>		
23 cm	5 mm		+	<b>50-206</b>		

130° Yukarıya doğru kesme/Upwards cutting



Standart ağız tabanlı  
Standard footplate



Ince ağız tabanlı  
With thin footplate



Standart ağız tabanlı  
Standard footplate



Ince ağız tabanlı  
With thin footplate

Ayrılabilir/Detachable

Boy Length	En Width	Ejektör Ejector	Ayrılabilir/Detachable			
18 cm	1 mm	-		50-213	50-229	50-243
18 cm	2 mm	-		50-214	50-230	50-244
18 cm	3 mm	+		50-215	50-231	50-245
18 cm	4 mm	+		50-216	50-232	50-246
18 cm	5 mm	+		50-217	50-233	50-247
18 cm	6 mm	+		50-218	-	50-248
20 cm	1 mm	-		50-219	50-234	50-249
20 cm	2 mm	-		50-220	50-235	50-250
20 cm	3 mm	+		50-221	50-236	50-251
20 cm	4 mm	+		50-222	50-237	50-252
20 cm	5 mm	+		50-223	50-238	50-253
20 cm	6 mm	+		50-224	-	50-254
23 cm	2 mm	-		50-225	50-239	50-255
23 cm	3 mm	+		50-226	50-240	50-256
23 cm	4 mm	+		50-227	50-241	50-257
23 cm	5 mm	+		50-228	50-242	50-258

130° Yukarıya doğru kesme/Upwards cutting













Standart ağız tabanlı  
Standard footplate



İnce ağız tabanlı  
With thin footplate

Standart/Standard

Boy Length	En Widht			
18 cm	1 mm		<b>50-274</b>	<b>50-294</b>
18 cm	2 mm		<b>50-275</b>	<b>50-295</b>
18 cm	3 mm		<b>50-276</b>	<b>50-296</b>
18 cm	4 mm		<b>50-277</b>	<b>50-297</b>
18 cm	5 mm		<b>50-278</b>	<b>50-298</b>
18 cm	6 mm		<b>50-279</b>	
20 cm	1 mm		<b>50-280</b>	<b>50-299</b>
20 cm	2 mm		<b>50-281</b>	<b>50-300</b>
20 cm	3 mm		<b>50-282</b>	<b>50-301</b>
20 cm	4 mm		<b>50-283</b>	<b>50-302</b>
20 cm	5 mm		<b>50-284</b>	<b>50-303</b>
20 cm	6 mm		<b>50-285</b>	<b>50-304</b>
21.5 cm	2 mm		<b>50-286</b>	<b>50-305</b>
21.5 cm	3 mm		<b>50-287</b>	<b>50-306</b>
21.5 cm	4 mm		<b>50-288</b>	<b>50-307</b>
21.5 cm	5 mm		<b>50-289</b>	<b>50-308</b>
23 cm	2 mm		<b>50-290</b>	<b>50-309</b>
23 cm	3 mm		<b>50-291</b>	<b>50-310</b>
23 cm	4 mm		<b>50-292</b>	<b>50-311</b>
23 cm	5 mm		<b>50-293</b>	<b>50-312</b>

130° Aşağıya doğru kesme/Downwards cutting



Standart ağız tabanlı  
Standard footplate

Ince ağız tabanlı  
With thin footplate

Standart ağız tabanlı  
Standard footplate

Ince ağız tabanlı  
With thin footplate

Ayrılabilir/Detachable

Standart/Standard

Boy Length	En Width	Ejektör Ejector				
18 cm	1 mm	□ -	50-313	50-326	50-339	50-352
18 cm	2 mm	□ -	50-314	50-327	50-340	50-353
18 cm	3 mm	□ +	50-315	50-328	50-341	50-354
18 cm	4 mm	□ +	50-316	50-329	50-342	50-355
18 cm	5 mm	□ +	50-317	50-330	50-343	50-356
21.5 cm	2 mm	□ -	50-318	50-331	50-344	
21.5 cm	3 mm	□ -	50-319	50-332	50-345	
21.5 cm	4 mm	□ +	50-320	50-333	50-346	
21.5 cm	5 mm	□ +	50-321	50-334	50-347	
23 cm	2 mm	□ -	50-322	50-335	50-348	50-357
23 cm	3 mm	□ +	50-323	50-336	50-349	50-358
23 cm	4 mm	□ +	50-324	50-337	50-350	50-359
23 cm	5 mm	□ +	50-325	50-338	50-351	50-360

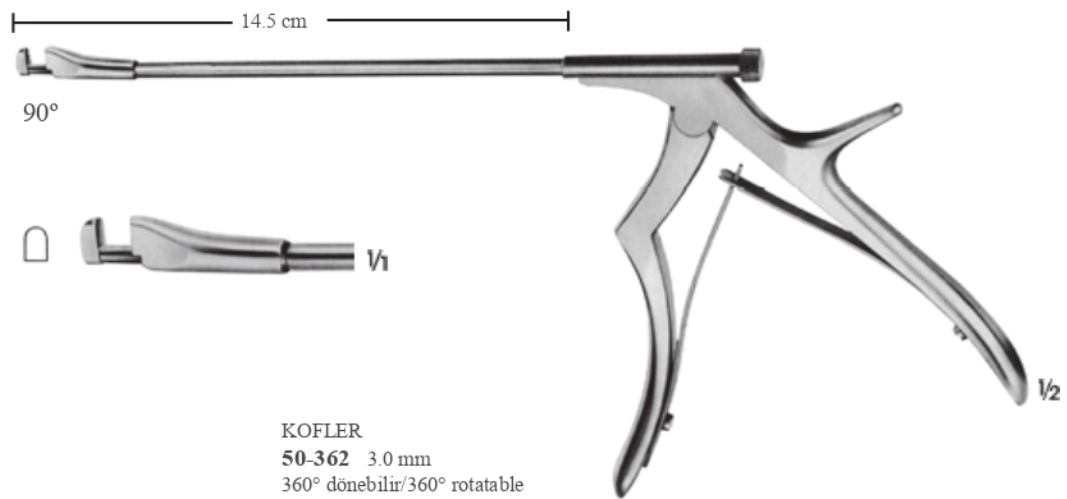
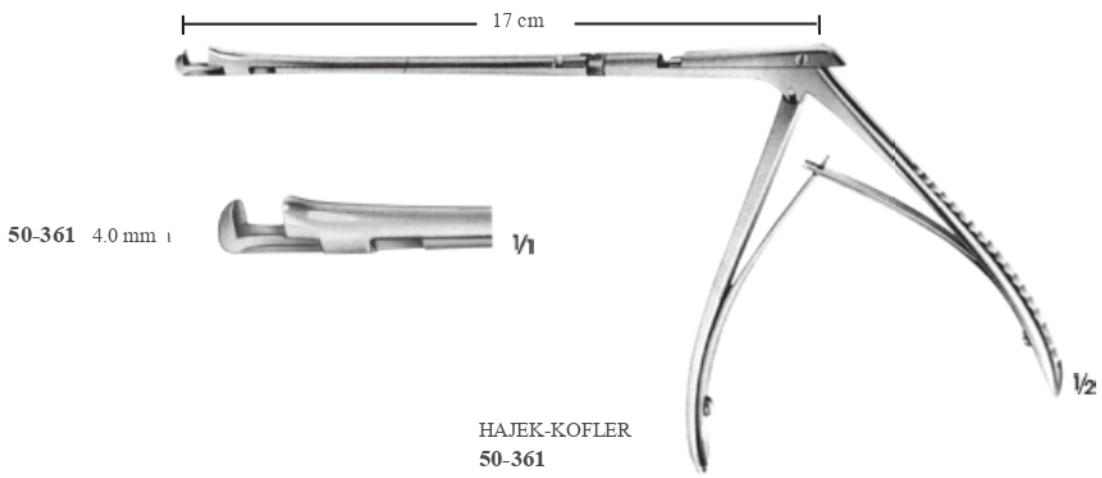



**KRAMER**  
**50-363** 15 cm  
 Bağ tutucu grasping pens, kilitli  
 With catch grasping forceps for  
 ligamentum flavum

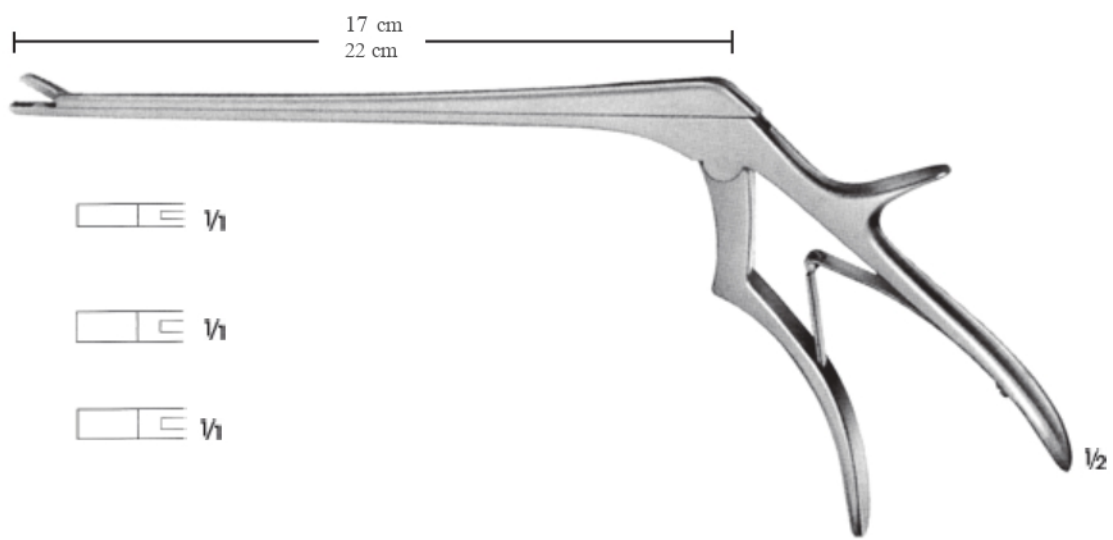

**CASPAR**  
**50-364** 3 mm  
 18 cm

**CASPAR**  
**50-365** 4 mm  
 18 cm

**CASPAR**  
**50-366** 4 mm  
 20.5 cm

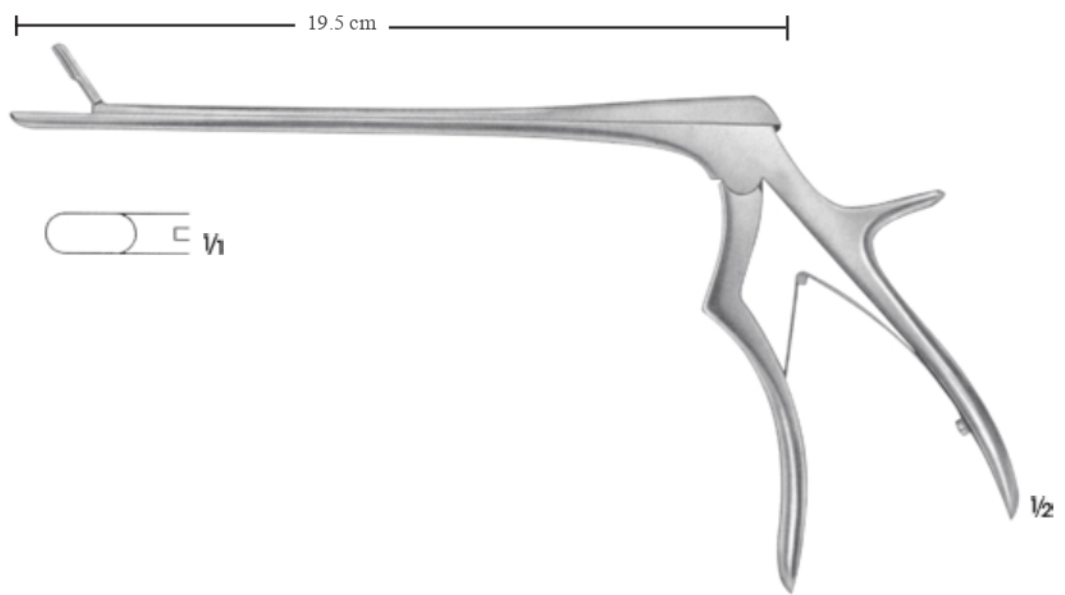

**WAGNER**  
**50-367** 5.5 mm



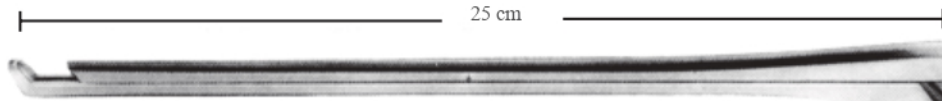

130° Yukarıya doğru kesme  
Upwards cutting



SYPERT  
50-368

1/2

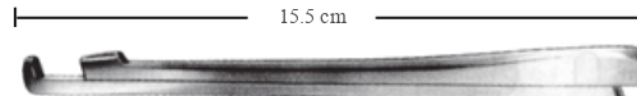

105° Yukarıya doğru kesme  
Upwards cutting



RICHTER  
50-369

1/2



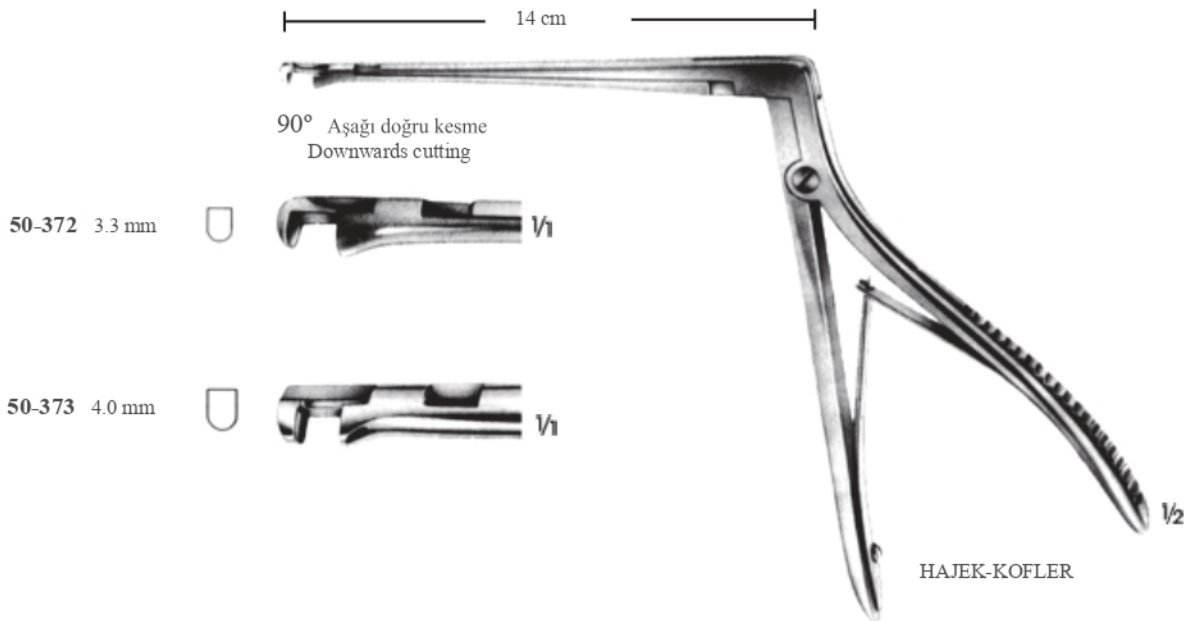
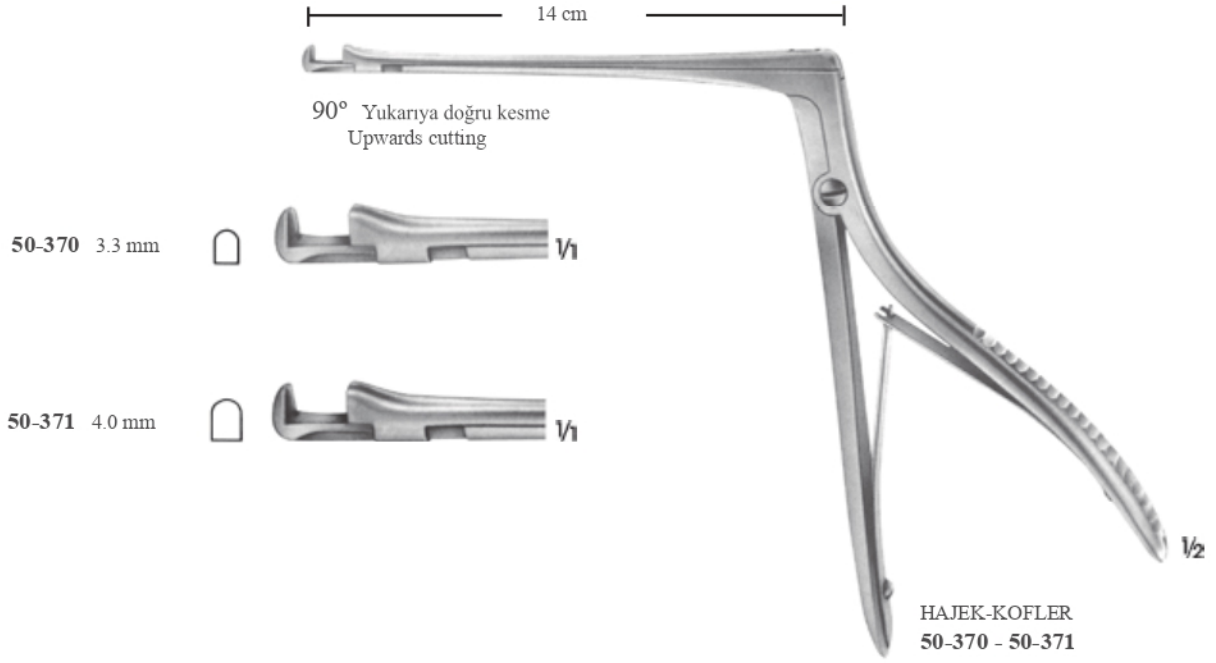

Pançlar için açılı pozisyonlar  
Angled positions for punches

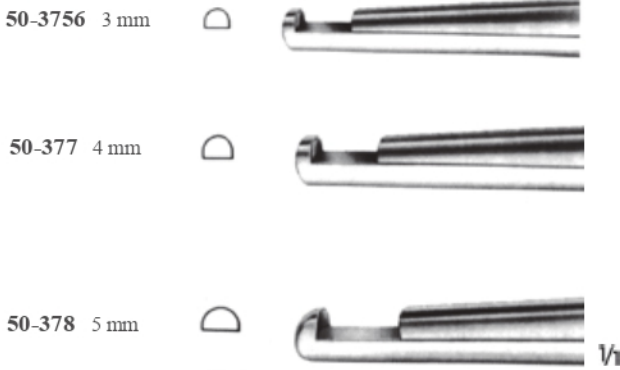
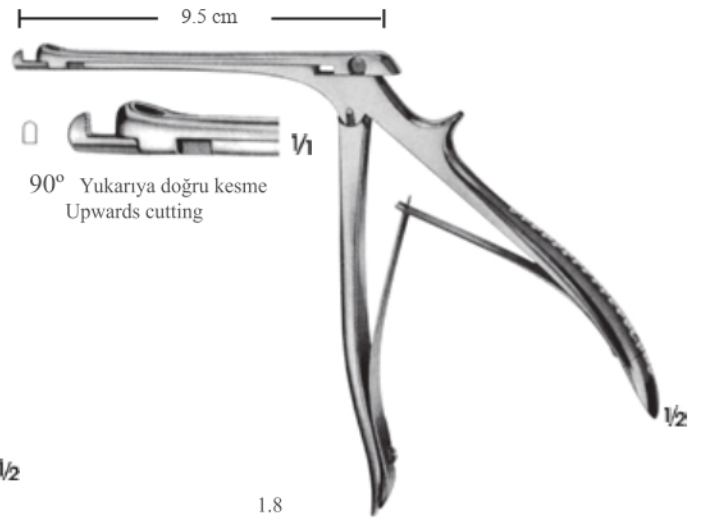
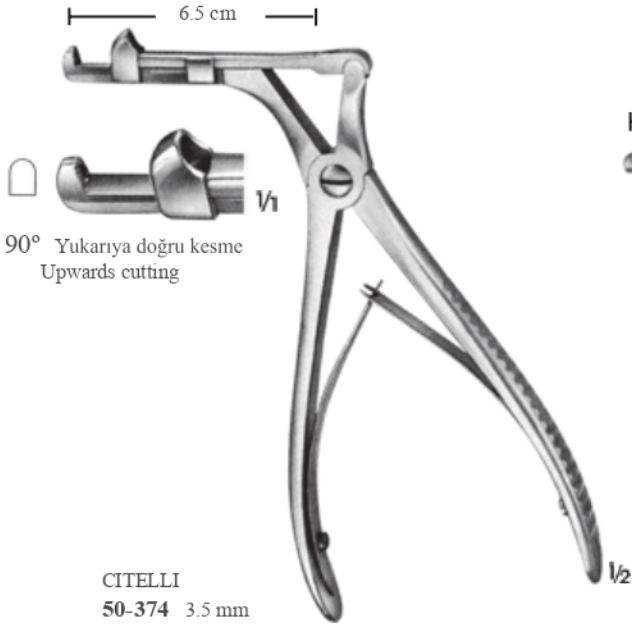
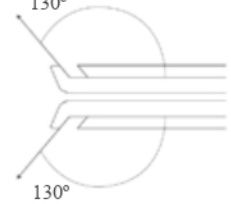
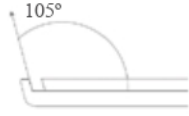

Silikon Kaplı Beyin Kaşığı  
Bükülebilir silikon kaplı elastik metal kaşık  
Atromatik açma  
Tek kullanımlık  
10'luk Paket

Silikone Coated Brain Spatula  
Malleable metal spatula with elastic silicone coating  
Atraumatic retraction  
For single use  
1 package of 10 pieces



**50-379** 6 mm  
20 cm



**50-380** 7.5 mm  
20 cm



**50-381** 10 mm  
20 cm



**50-382** 12.5 mm  
20 cm



**50-383** 15 mm  
20 cm



**50-384** 7 + 8 mm  
**50-385** 10 + 11 mm  
**50-386** 13 + 14 mm  
**50-387** 16 + 17 mm  
**50-388** 19 + 20 mm  
**50-389** 22 + 25 mm  
 Bükülebilir/Malleable  
 20 cm



**50-390** 9 mm  
**50-391** 12 mm  
 20 cm  
**50-392** 12 mm  
 25 cm  
**50-393** 13 X 19 mm  
**50-394** 15 X 19 mm  
**50-395** 19 X 25 mm  
 20 cm  
 Bükülebilir/Malleable



HEIFETZ  
**50-396** 8 mm  
**50-397** 11 mm  
**50-398** 14 mm  
**50-399** 17 mm  
**50-400** 20 mm  
 Bükülebilir/Malleable  
 20 cm



HEIFETZ  
**50-401** 8 mm  
**50-402** 11 mm  
**50-403** 14 mm  
**50-404** 17 mm  
 Bükülebilir/Malleable  
 15.5 cm



**50-405** 12 mm  
**50-406** 17 mm 20  
 cm  
**50-407** 25 mm 25  
 cm  
 Bükülebilir/Malleable



**50-408** 7 + 9 mm  
**50-409** 11 + 13 mm  
**50-410** 15 + 18 mm  
**50-411** 18 + 22 mm  
 Bükülebilir/Malleable  
 18 cm



OLIVECRONA  
**50-412** 7 + 9 mm  
**50-413** 11 + 13 mm  
**50-414** 15 + 18 mm  
**50-415** 18 + 22 mm  
 Esneyebilir/Flexible  
 18 cm





50-416 Ø 4 mm  
43.5 cm  
50-417 Ø 4 mm  
60 cm

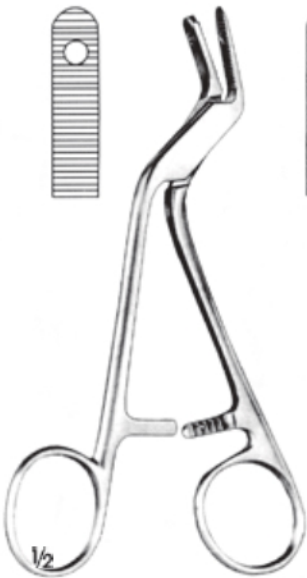

ADSON  
50-418  
15 cm



50-419  
Koruma pensi  
Protection forceps  
20.5 cm

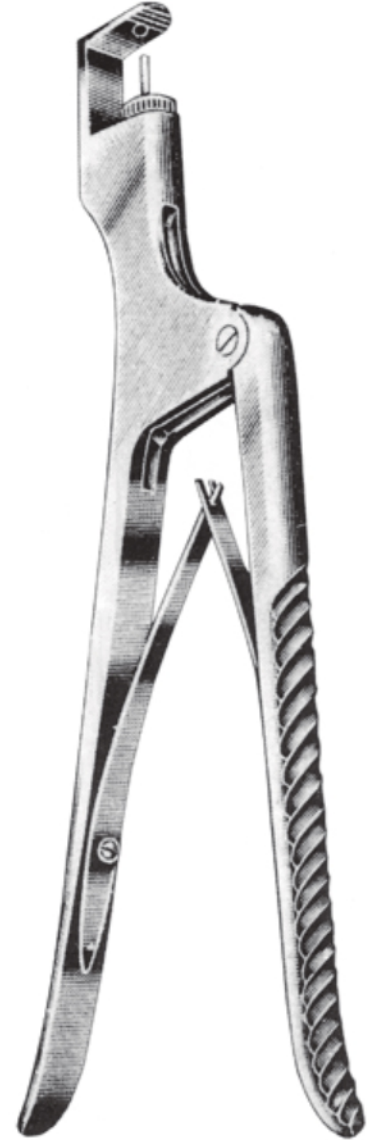

SWEET  
50-420 20 cm  
50-421 23 cm

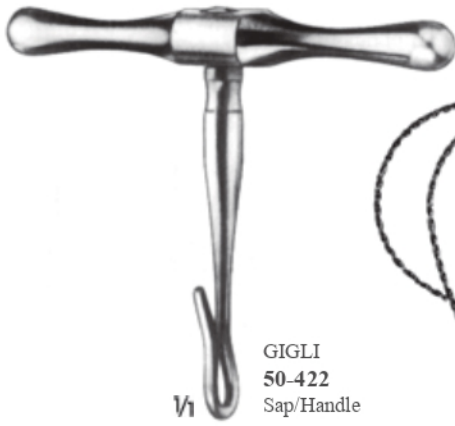

GIGLI  
50-422  
Sap/Handle



GIGLI  
50-423 30 cm  
50-424 40 cm  
50-425 50 cm  
İki sargılı/Two windings

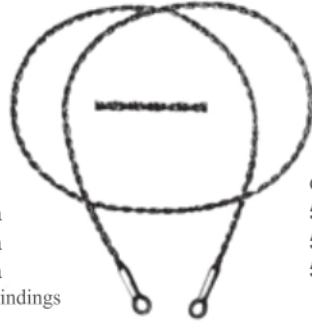

GIGLI  
50-426 30 cm  
50-427 40 cm  
50-428 50 cm  
Üç sargılı/Three winding



DE MARTEL 50-429  
35 cm  
Kondüktör için gigli testere teli, esnek  
Gigli saw for the flexible conductor wire



DAHLGREN



1/2  
DAHLGREN  
50-430  
2 huk ile birlikte  
With 2 extra hooks  
21 cm



1/2  
DE VILBISS  
50-431  
1huk dahil/with 1 hook  
20 cm



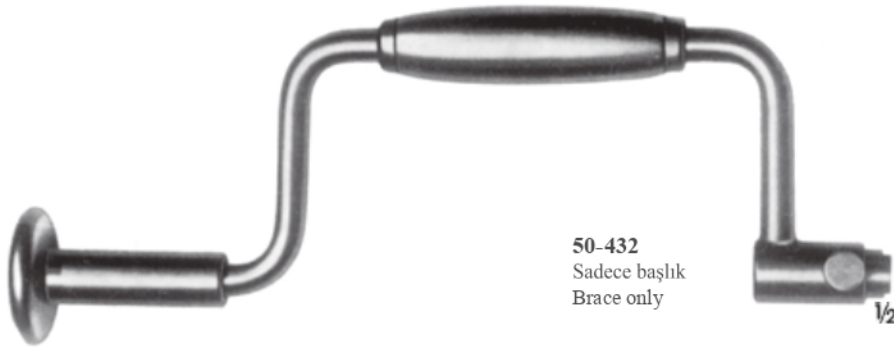

50-434  
Sadece Başlık  
Brace only

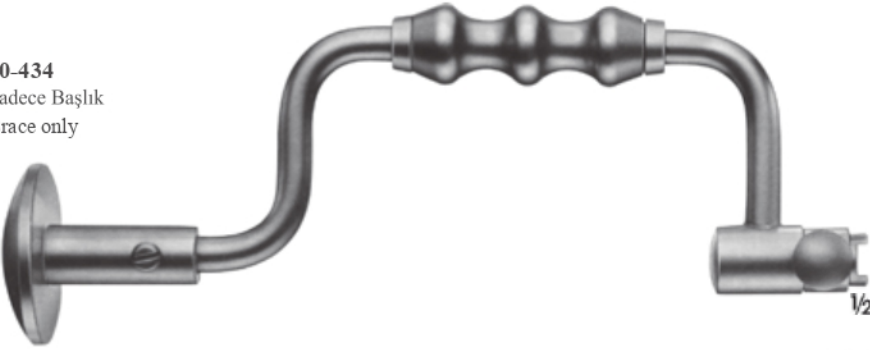

HUDSON  
50-436  
El matkabı  
Hand drill

HUDSON DOWNS

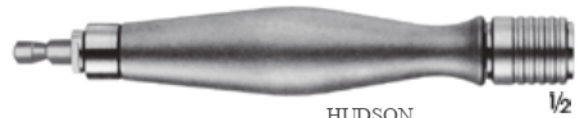

CUSHING  
50-438  
Ø 10 mm



CUSHING  
50-439  
Ø 15 mm



CUSHING  
50-440  
Ø 14 mm



McKENZIE  
50-441  
Ø 13 mm



HUDSON  
50-442  
Ø 14 mm



HUDSON  
50-443  
Ø 16 mm



ADSON  
50-444  
Ø 15 mm



HUDSON  
50-445  
Ø 22 mm



HUDSON  
50-446  
Ø 9 mm



50-447  
Ø 2 mm



Galea tespitinde kullanılan Buldog klempı yaylı kanca, örtü bezine bağlanabilir.  
Spring hook for galea fixation with Bulldog clamp, to be fastened to covering drape.



YASARGIL  
50-449  
26 cm



YASARGIL  
50-450  
28 cm



50-451  
28 cm



50-452  
28 cm

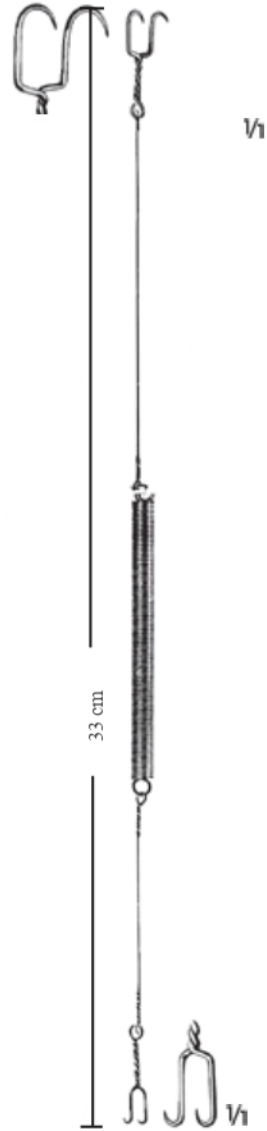

50-453  
33 cm





**RANEY**  
**50-454**  
16 cm



**McKENZIE**  
**50-455**  
15 cm

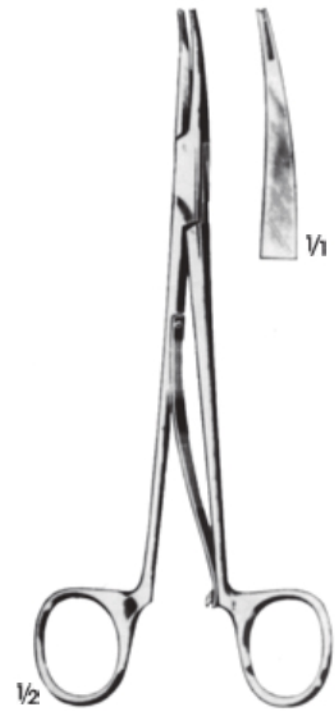

**McKENZIE**  
**50-456**  
19 cm



**50-457** 25°  
15 cm  
**50-458** 25°  
20 cm  
**50-459** 25°  
28 cm



**50-460** 65°  
20 cm  
**50-461** 65°  
28 cm



**50-462** 25°  
15 cm  
**50-463** 25°  
20 cm  
**50-464** 25°  
28 cm



**50-465** 65°  
20 cm  
**50-466** 65°  
28 cm



**50-467** 25°  
20 cm  
**50-468** 25°  
28 cm





1.0 mm  
Eğri/Curved



CASPAR  
50-469  
20 cm



50-470 3 mm  
Künt/Blunt  
18.5 cm



50-471 3 mm  
Künt/Blunt  
21.5 cm



YASARGIL 50-472  
mm Çocuklar için,  
esnek Flexible for  
children 19.5 cm



YASARGIL  
50-473 7 mm  
Flexible for adults  
19.5 cm



JACOBSON  
Sonda, küresel uçlu  
Probe with ball tip  
18.5 cm

50-474

50-475

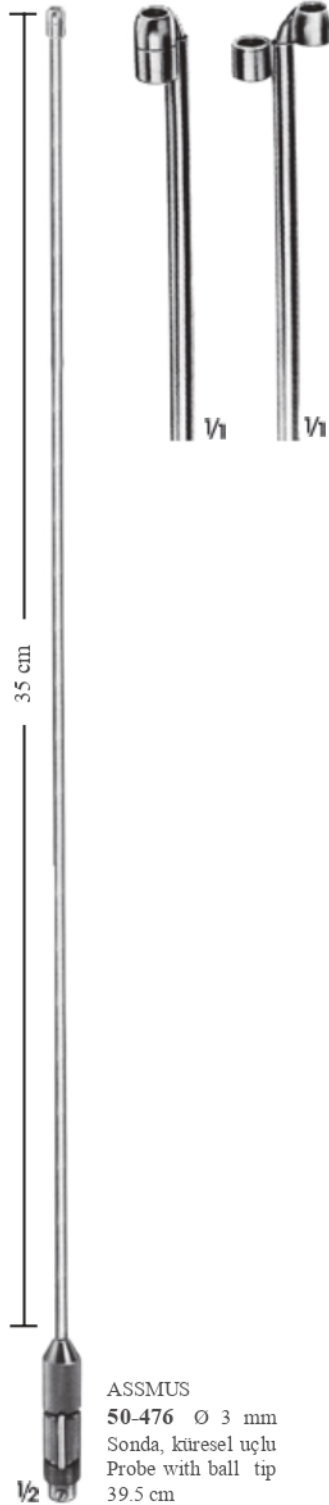

ASSMUS  
50-476 Ø 3 mm  
Sonda, küresel uçlu  
Probe with ball tip  
39.5 cm

35 cm



CASPAR  
50-477  
Ligatür ayarlayıcısı  
Ligature adjuster  
23 cm









**YASARGIL  
50-491**  
Mikro raspa, açılı  
Micro raspatory,  
angled  
18.5 cm



**YASARGIL  
50-492**  
Mikro disektör, açılı  
Micro dissector,  
angled  
18.5 cm



**YASARGIL  
50-493**  
Mikro disektör, açılı  
Micro dissector,  
angled  
18.5 cm



**YASARGIL  
50-494**  
Mikro raspa, hafif  
kavisli  
Micro raspatory,  
slightly curved  
18.5 cm



**YASARGIL  
50-495**  
Mikro raspa, eğri  
Micro raspatory,  
curved  
18.5 cm



**YASARGIL  
50-496**  
Mikro raspa, aşağı eğimli  
Micro raspatory, down-  
wards curved  
18.5 cm



**YASARGIL  
50-497**  
Mikro raspa, aşağı eğimli  
Micro raspatory, down-  
wards curved  
18.5 cm

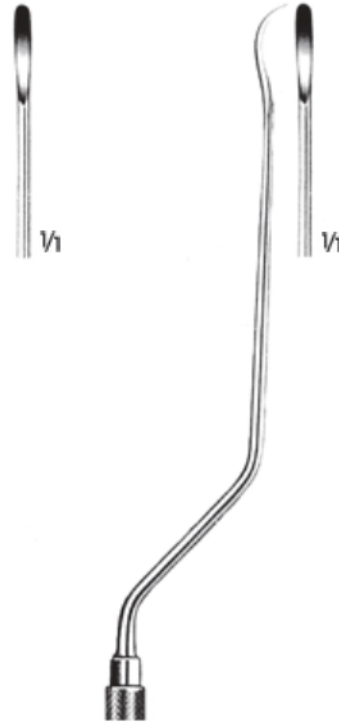

**YASARGIL  
50-498**  
Mikro raspa, yukarı eğimli  
Micro raspatory, up-  
wards curved  
18.5 cm

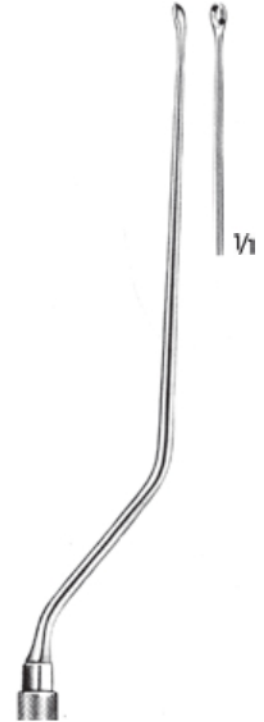

**YASARGIL  
50-499**  
Mikro kaşık küret  
Micro scoop  
18.5 cm

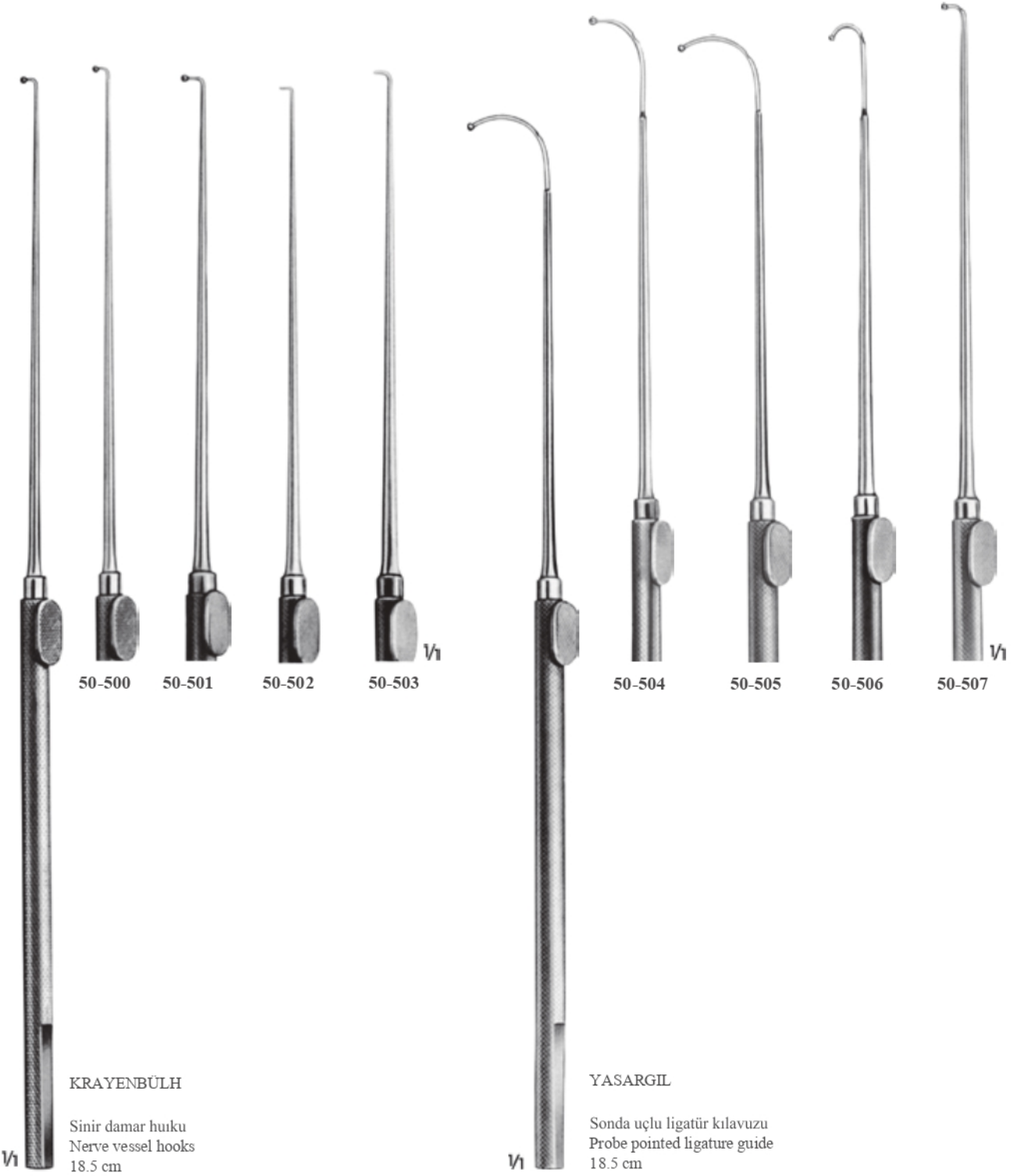



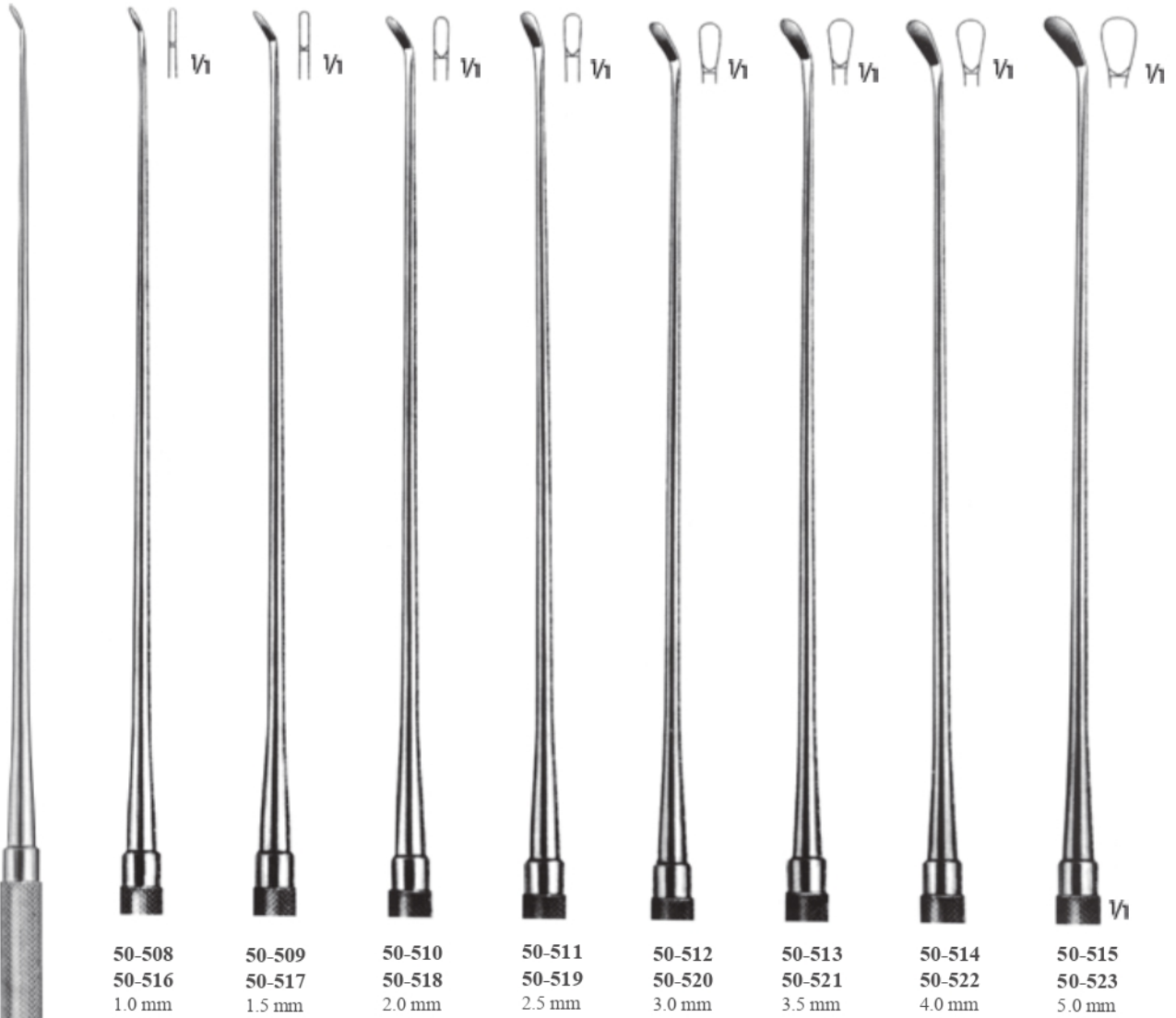

SAMII  
50-508 - 50-515  
20 cm  
50-516 - 50-523  
23 cm

Vi



**50-524**  
Doku piki  
Tissue pick  
18.5 cm



**50-525**  
Sivri huk 90° açılı  
Sharp hook, 90°  
angled  
18.5 cm



**FISCH**  
**50-526**  
Sivri huk 90° açılı  
Sharp hook, 90°  
angled  
18.5 cm



**CASPAR**  
**50-527 - 50-530**  
Keşif hukları sonda uçlu  
Exploration hooks, probe-pointed  
24.5 cm

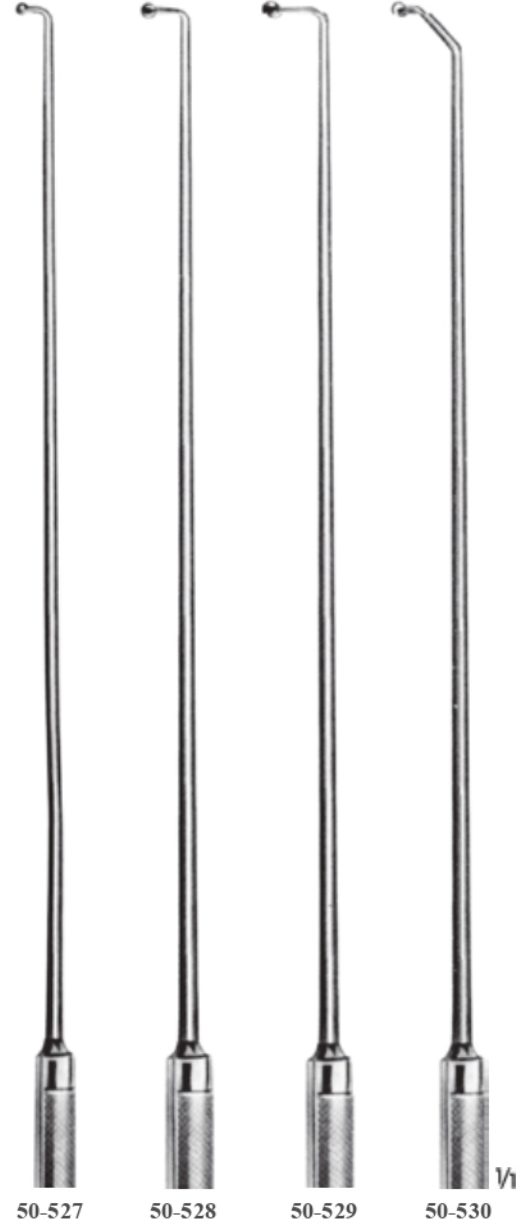



Mikro huk/Sivri  
Micro hook/Sharp  
23 cm



**50-531**  
Mikro huk, künt  
Micro hook, blunt  
23 cm



**50-532**  
Mikro disektör, düz  
Micro dissector,  
straight  
23 cm



**50-533**  
Mikro disektör, düz  
Micro dissector,  
straight  
23 cm



**50-534**  
Mikro keççe düz,  
keskin  
Micro scoop,  
straight, sharp  
23 cm



**50-535**  
Mikro keççe açılı,  
keskin  
Micro scoop,  
angled, sharp  
23 cm



**50-536**  
Mikro raspa,  
yuvarlak bıyık  
Micro raspatory,  
round blade  
23 cm





V1  
18.5 cm



KOOS  
**50-537**  
Yukarı eğimli  
Curved upwards



KOOS  
**50-538**  
Aşağı eğimli  
Curved downwards



KOOS  
**50-539**  
Yukarı eğimli  
Curved upwards



KOOS  
**50-540**  
Aşağı eğimli  
Curved downwards



KOOS  
**50-541**  
Aşağı eğimli  
Curved downwards



KOOS  
**50-542**  
Yukarı eğimli  
Curved upwards



YAŞARGIL  
**50-543**  
Aşağı eğimli  
Curved downwards



YAŞARGIL  
**50-544**  
Yukarı eğimli  
Curved upwards





V1



50-545  
1.8 mm



V1



50-546  
2.5 mm



V1

V1

SAMII  
Tümör dokusu için bistüri  
Lancet knives for tumor tissue  
23 cm



V1



50-547  
Ø 1.5 mm



50-548  
Ø 3.0 mm



50-549  
Ø 4.5 mm



50-550  
Ø 6.0 mm



V1



V1

SAMII  
Tümör dokusu için bıçaklar  
Knives for tumor tissue  
23 cm



LANDOLT  
**50-551** Sağ, künt  
Blunt, right  
26 cm  
**50-552** Sol,  
künt Blunt, left  
Bükülebilir/Malleable  
26 cm



LANDOLT  
**50-553**  
Küret, bükülebilir  
Curette, malleable  
26 cm



LANDOLT  
**50-554**  
Kaşık, bükülebilir  
Spoon, malleable  
26 cm



LANDOLT  
**50-555**  
Künt huk/Blunt hook  
Bükülebilir/Malleable  
26 cm

LANDOLT  
Malleable  
26 cm



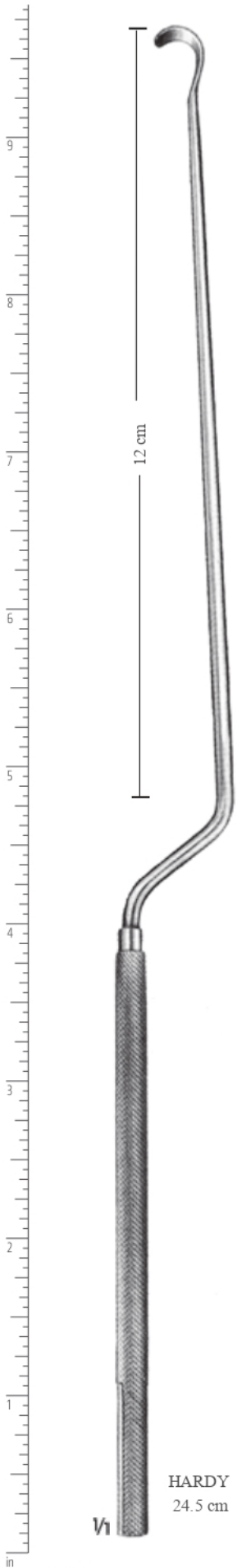

HARDY  
24.5 cm

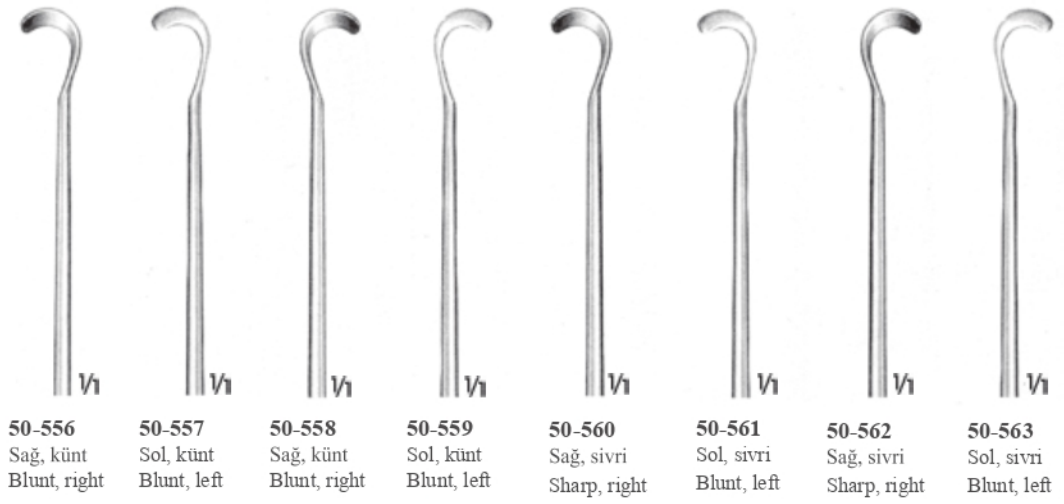

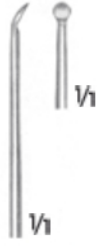
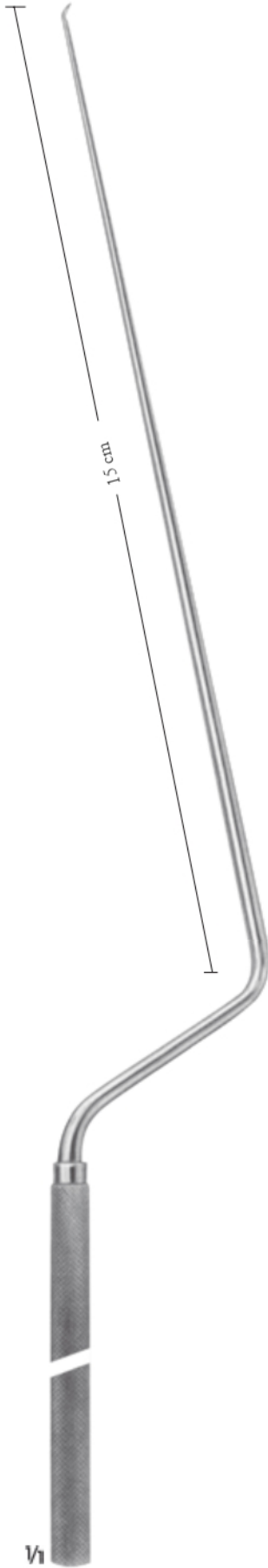

LANDOLT-REULEN  
**50-564** Ø 2.2 mm  
Raspa, esnemez  
Raspatories, rigid  
26 cm



LANDOLT-REULEN  
**50-565** Ø 3.2 mm  
Raspa, esnemez  
Raspatories, rigid  
26 cm



LANDOLT-REULEN  
**50-566** Ø 2.5 mm  
Küret, esnemez  
Curette, rigid  
26 cm



LANDOLT-REULEN  
**50-567** Ø 1.7 mm  
Künt huk/Blunt hook  
26 cm



FAHLBUSCH  
**50-568** Ø 2.0 mm  
Kaşık, bükülebilir  
Spoon, malleable  
26 cm



FAHLBUSCH  
**50-569** Ø 2.5 mm  
Küret, bükülebilir  
Curette, malleable  
26 cm







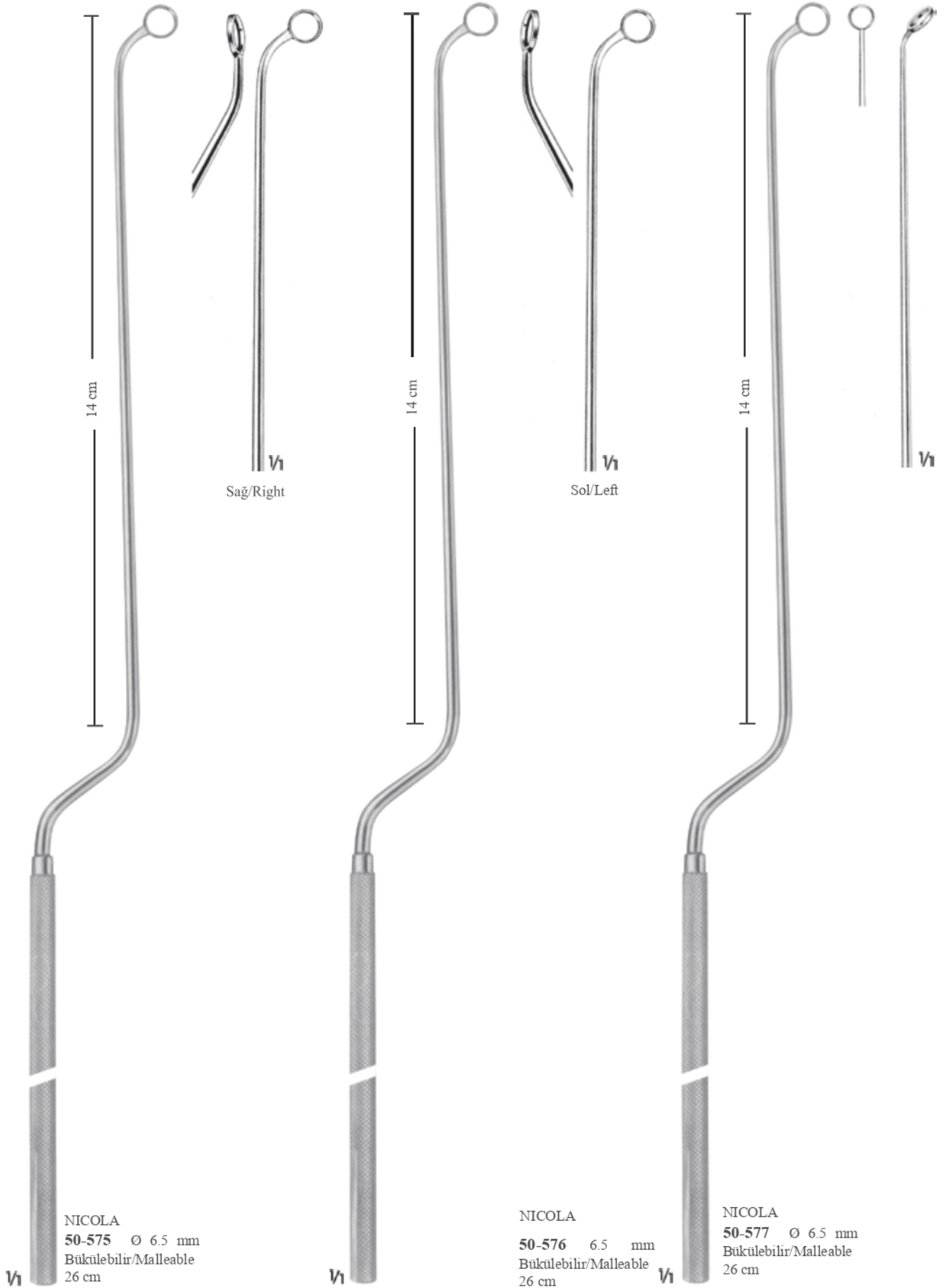



RAY  
50-578 Ø 4 mm  
Küret 45° dikey  
Curette vertical 45°  
18 cm



RAY  
50-579 Ø 4 mm  
Küret 45° Yatay  
Curette Horizontal 45°  
18 cm

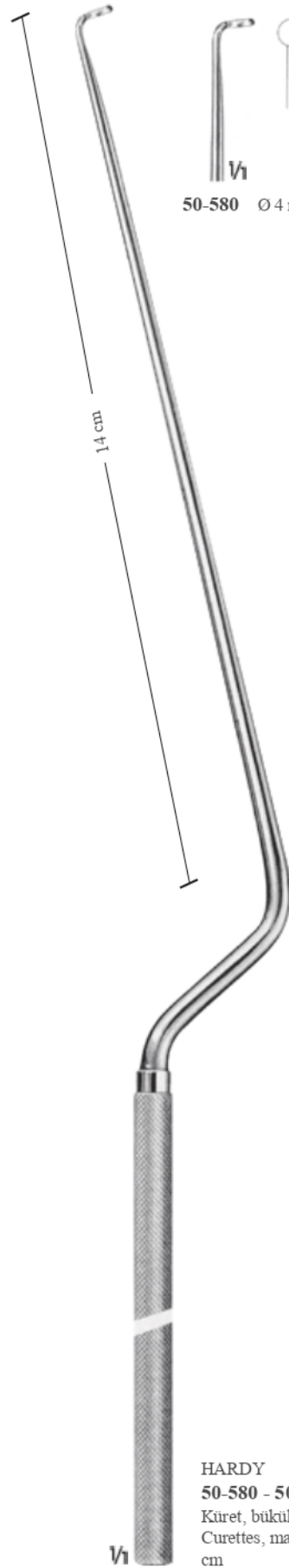

HARDY  
50-580 - 50-581  
Küret, bükülebilir  
Curettes, malleable 26  
cm

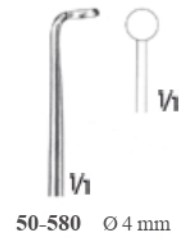

50-580 Ø 4 mm



50-581 Ø 6 mm



Blayd No.3  
Blade No.3



**50-582**  
Bistüri sapı  
Scalpel handle  
21 cm



CASPAR  
**50-583**  
Mikro bıçak,künt  
Micro knife, blunt tip  
20 cm



CASPAR  
**50-584**  
Mikro bıçak,künt  
Micro knife, blunt tip  
20 cm





**50-585**  
Ayna sapı  
Mirror handle  
10.5 cm

**50-586**  
Laringel ayna  
Laryngeal mirror  
12 cm



**50-587**  
Altıgen saplı Laringel  
aynar  
Laryngeal mirror with  
Hexagonal handle  
18 cm



**YASARGIL**  
**50-588** Ø 6 mm  
Hareketli mikro ayna  
Movable micro mirror  
24 cm

**50-589**  
Ayna/Mirror  
26 cm



MAYFIELD  
50-590  
Kafa klempi/Skull clamp



GARDNER  
50-591 10 mm  
Yetişkinler için  
Adult size  
25 mm



MAYFIELD  
50-592  
Yetişkinler için  
Adult size



MAYFIELD  
50-593  
Çocuklar için  
Child size



GARDNER  
50-594 6 mm  
Çocuklar için  
Child size  
38 mm



MT.SINAI  
50-595 10 mm  
Çocuklar için  
Child size  
38 mm

Çivili başlıklı masa bağlantı seti  
Set for fixing skull clamp



MAYFIELD  
50-602 Komple/Complete

MAYFIELD  
50-596  
Kafa klempi/Skull clamp

MAYFIELD  
50-597  
Masa bağlantı aparatı  
Table fixation attachment

MAYFIELD  
50-598  
Masa bağlantı aparatı  
Table fixation attachment

MAYFIELD  
50-599  
Masa bağlantı aparatı  
Table fixation attachment

MAYFIELD  
50-600  
Masa bağlantı aparatı  
Table fixation attachment

MAYFIELD  
50-601  
Masa bağlantı aparatı  
Table fixation attachment



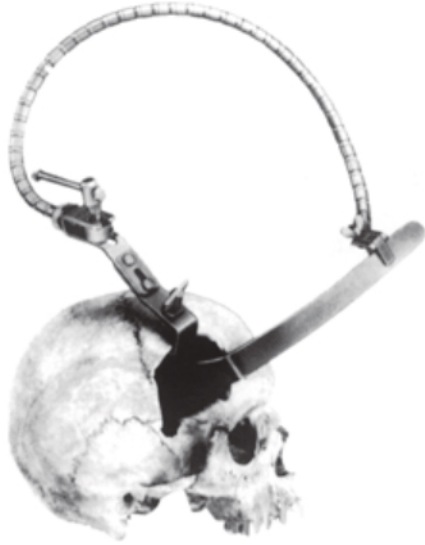

**YASARGIL**  
**50-603**  
Tek kollu komple otomatik beyin ekartörü  
Self-retaining brain retractor, with 1 flexible  
arm, complete, consisting of:

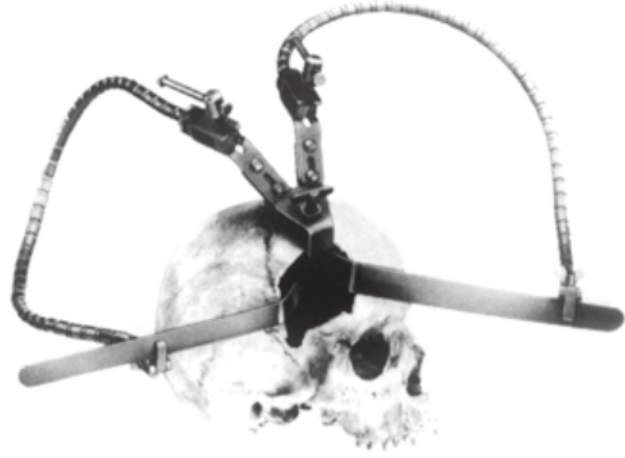

**YASARGIL**  
**50-604**  
İki kollu komple otomatik beyin ekartörü  
Self-retaining brain retractor, with 1 flexible  
arm, complete, consisting of:



**50-605**  
Tespit elemanı  
Fixation base



**YASARGIL**  
**50-608**  
Yalnız esnek kol  
Flexible arm only

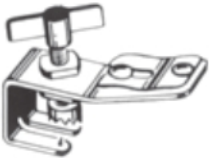

**50-606**  
Tespit elemanı  
Fixation base



**50-607**  
Tespit elemanı  
Fixation base



**50-609**  
Kaşık tutucu/Support only

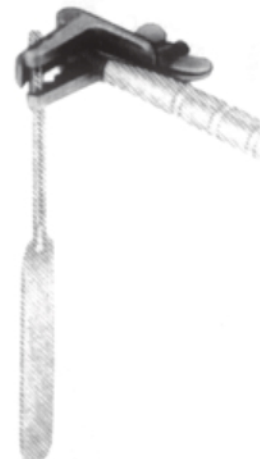

**50-610**  
Kaşık tutucu/Support only



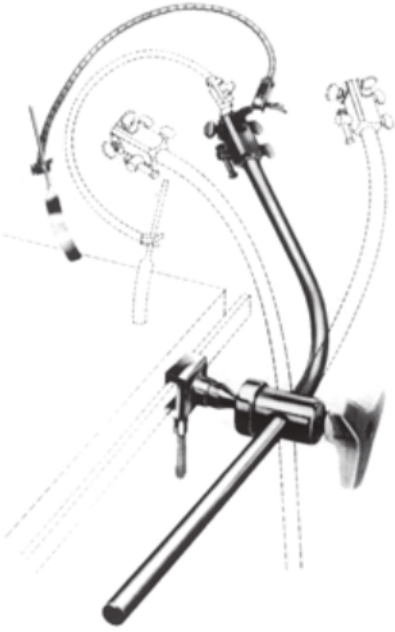

50-611

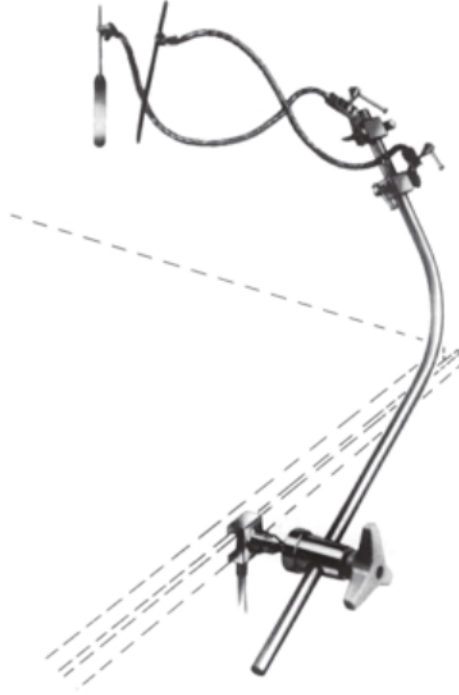

50-612



50-613  
Bağlantı başlığı  
Coupling head



50-614  
Masa bağlantı mafsalı  
Joint for table fixation  
maximum 9 x 32 mm

50-615  
Masa bağlantı mafsalı  
Joint for table fixation  
10 x 25 mm



50-616  
Döner bağlantı başlığı  
Turnable coupling head

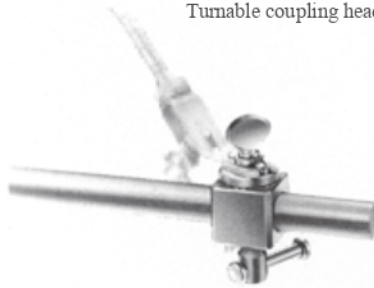

50-617  
Döner bağlantı başlığı  
Turnable coupling head

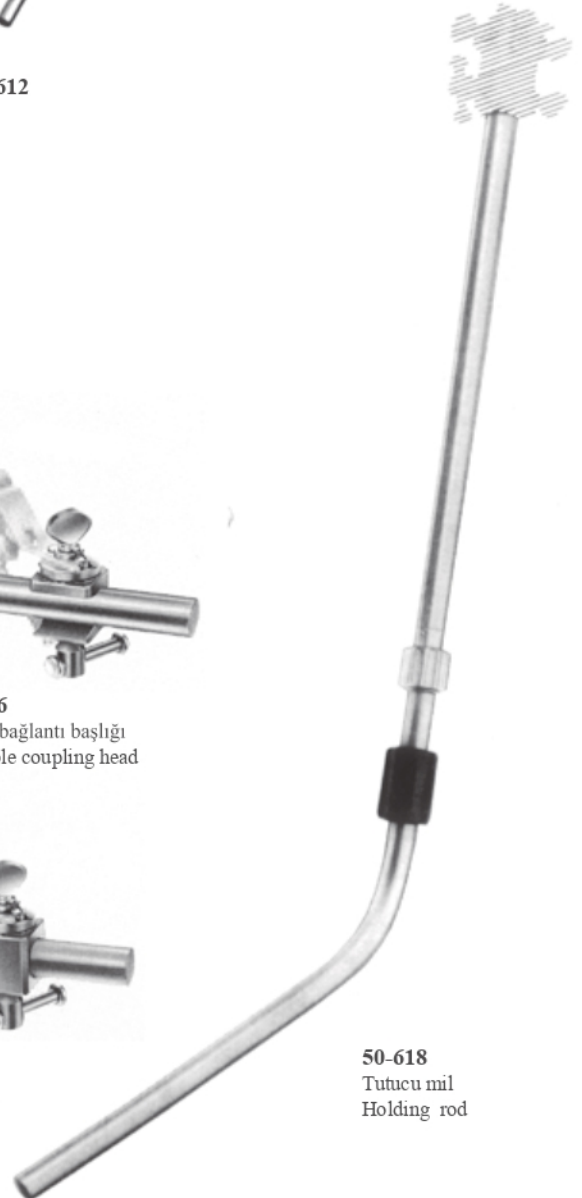

50-618  
Tutucu mil  
Holding rod





50-619 Masa bağlantı elemanı/Table Fixation attachment

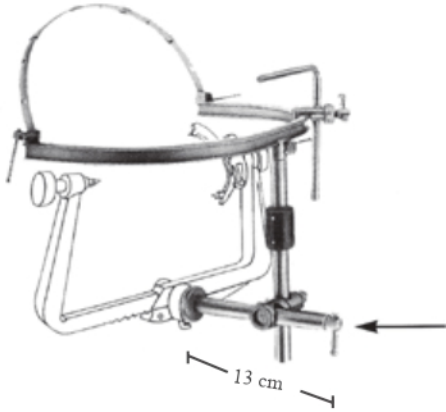

50-622 Komple/Complete

50-623 Masa bağlantı elemanı/Table Fixation attachment(1 adet)

50-624 Masa bağlantı elemanı/Table Fixation attachment (1 pcs)



50-625 Masa bağlantı elemanı/Table Fixation attachment

50-626 Tutucu mil/Holding rod

50-627 Masa bağlantı mafsalı/Joint for table fixation  
9 x 32 mm

50-628 Masa bağlantı mafsalı/Joint for table fixation  
10 x 25 mm



50-629  
Pens tutucu  
Holder for forceps

GILSBACH  
50-630  
El dayama barı  
Handrest bar

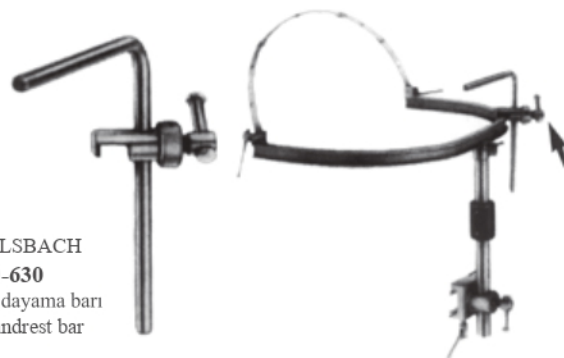



GILSBACH

**50-631** (Komple/Complete)

Temel ünite/Basic unit

**50-632** Tutucu mil/Holding rod

**50-633** Esnek kollar için yarım daire bar/Semi-circular basic bar, for flexible arms

**50-634** Galea hukları için çerçeve/Frame for Galea hook

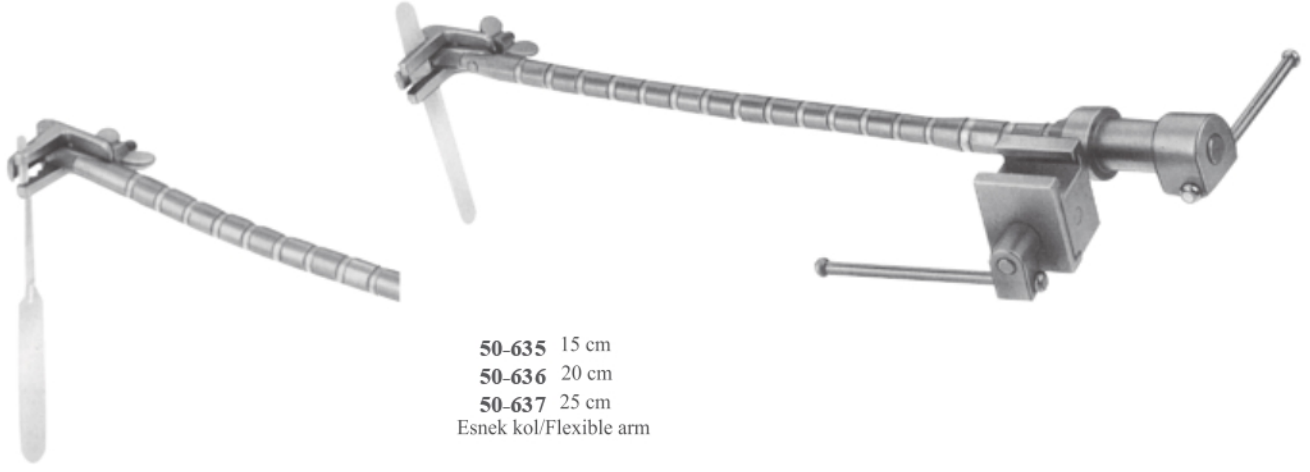

**50-635** 15 cm  
**50-636** 20 cm  
**50-637** 25 cm  
Esnek kol/Flexible arm

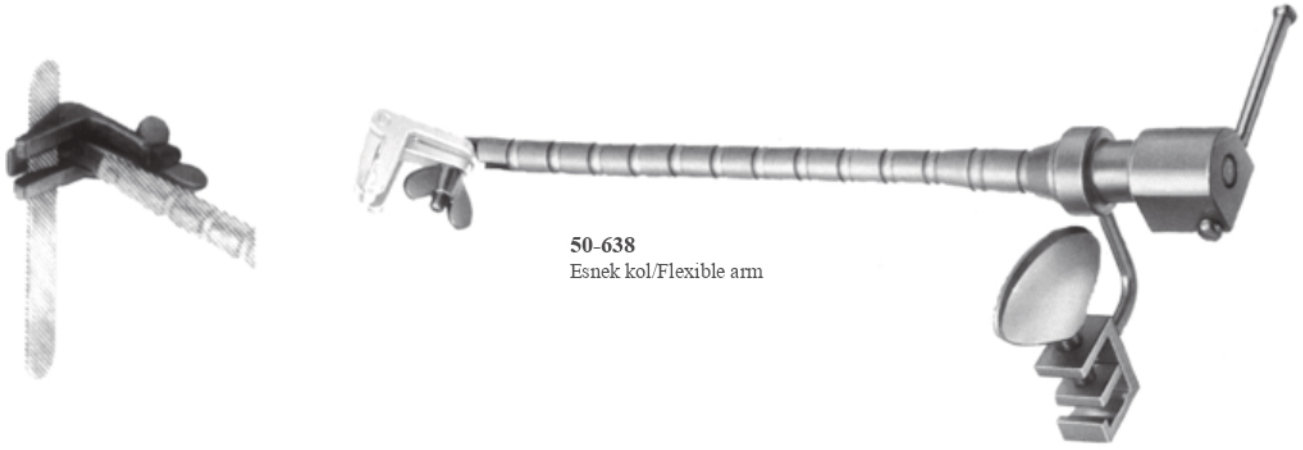

**50-638**  
Esnek kol/Flexible arm



**50-639**  
Kaşık tutucu  
Support only



**50-640**  
Kaşık tutucu  
Support only

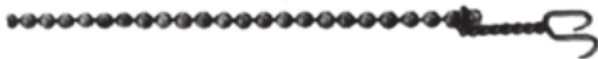

**50-641**  
Zincirli huk



**50-642**  
Yaylı huk



YASARGIL  
50-643 Mini/Mini  
50-644 Standart/Standard  
17,5 cm



YASARGIL  
50-645 Mini/Mini  
50-646 Standart/Standard  
17,5 cm

Mini/Mini Standart/Standard

50-647 50-650  
Düz/Straight



50-648 50-651  
15° Açılı/15° Angled



50-649 50-652  
30° Açılı/30° Angled



YASARGIL  
50-647 - 50-650  
50-648 - 50-651  
50-649 - 50-652  
21.5 cm

50-653 50-656  
Düz/Straight



50-654 50-657  
15° Açılı/15° Angled



50-655 50-658  
30° Açılı/30° Angled

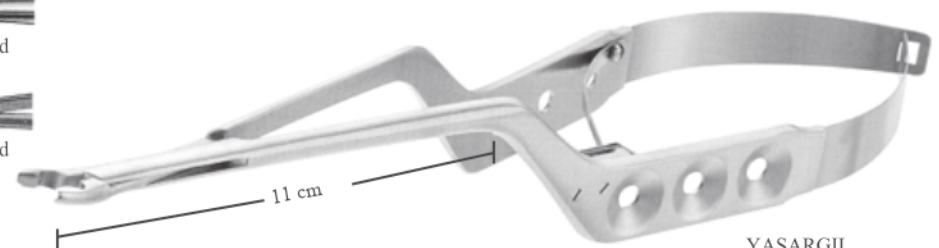

YASARGIL  
50-653 - 50-656  
50-654 - 50-657  
50-655 - 50-658  
23.5 cm



50-659  
Hizalama anahtarı  
Alignment key



50-660 Mini/Mini  
50-661 Standart/Standard  
21.5 cm



CUSHING-LANDOLT  
**50-662** 70 x 15 mm  
**50-663** 90 x 15 mm  
**50-664** 110 x 15 mm  
Transsfenoidal, hipofizektomi spekulum  
Specula for transsphenoidal hypophysectomy



JANSEN-MIDDLETON  
**50-665**  
20 cm



PAPAVERO  
**50-666** 4 mm  
Bayonet çızıl  
Bayonet chisel, 4 mm  
22 cm



LANDOLT  
**50-667**  
Spekulum için ayırıcı  
Spreader for specula  
L 295.00-L 295.02  
21 cm



COTTLE  
**50-668** 240 gr  
Çekiç, bir tarafı düz  
bir tarafı dış bükey  
Mallet, 1 side flat, 1  
side convex  
18.5 cm



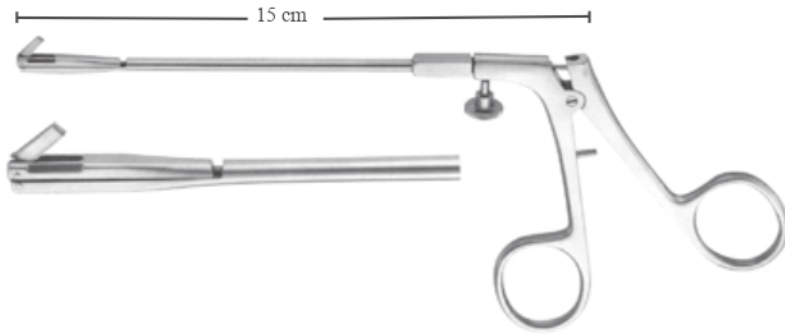

**50-669**  
Antrum panç  
Antrum punch



**50-677**  
Anahtar/Key  
15 cm

PAPAVERO-CASPAR  
**50-670** 80 x 11 mm  
**50-671** 90 x 13 mm  
**50-672** 100 x 15 mm



Ince profilli, hafif transsfenoidal spekulum  
Slim profile and lightweighted specula for  
transsphenoidal

HardCoated



**50-673**  
90 x 13 mm  
Transsfenoidal spekulum  
Transsphenoidal specula

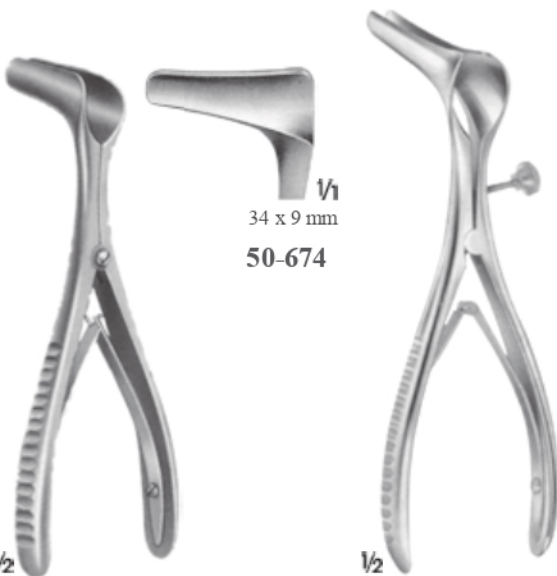

$\frac{1}{2}$   
34 x 9 mm  
**50-674**

$\frac{1}{2}$   
PAPAVERO-HARTMANN

$\frac{1}{2}$   
COTTLE  
13.5 cm

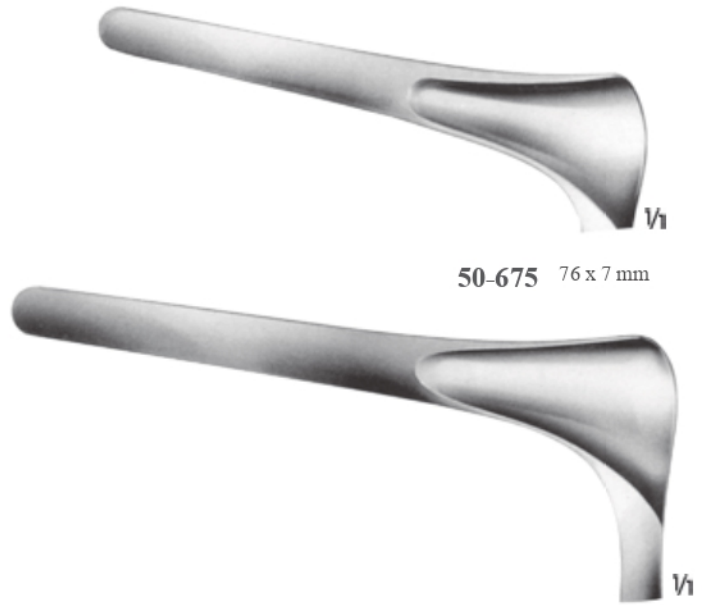

$\frac{1}{2}$   
**50-675** 76 x 7 mm

$\frac{1}{2}$   
**50-676** 90 x 7 mm



CLOWARD  
**50-678**  
Sadece ekartör  
Retractor only  
25 cm

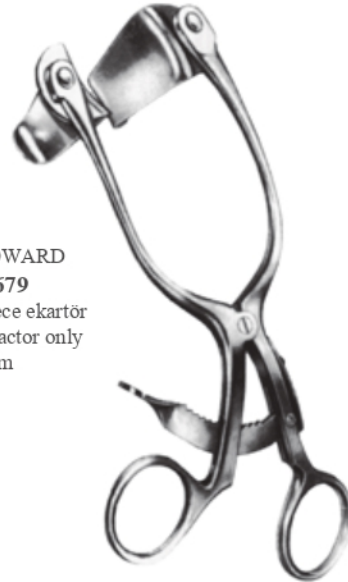

CLOWARD  
**50-679**  
Sadece ekartör  
Retractor only  
15 cm

CLOWARD



**50-680**



**50-681**

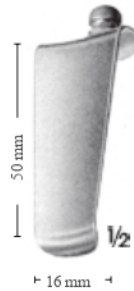

**50-682**

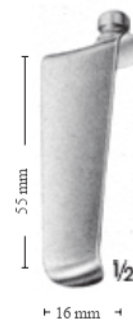

**50-683**

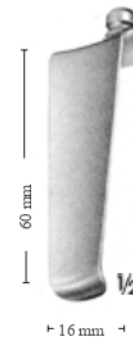

**50-684**

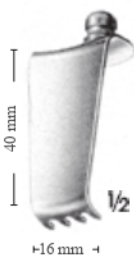

**50-685**



**50-686**



**50-687**



**50-688**



**50-689**

128-02 Komple/Complete





CLOWARD  
50-690 18 mm  
50-691 20 mm  
50-692 23 mm  
18 cm



CLOWARD  
50-693  
Koter huku/Coutery hook  
20 cm



CLOWARD  
50-694  
10 x 8 mm  
19 cm



CLOWARD  
50-695  
20 x 12 mm  
20 cm



1/2

CLOWARD  
50-696 230 gr.  
19 cm



CLOWARD  
50-697 5 mm  
50-698 8 mm  
50-699 10 mm  
50-700 12 mm  
20 cm



4 mm

CLOWARD  
50-701  
18 cm



CLOWARD  
50-702  
20 cm





**CLOWARD**  
**50-703**  
Graft alma kolu  
Dowel cutter shaft  
16.5 cm

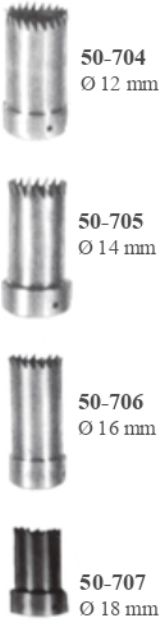

Dowel cutters  
Graft alma matkapları

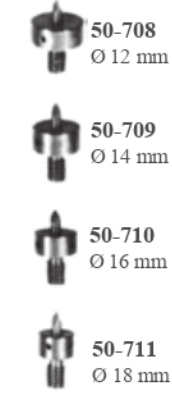

Merkezleme pimleri  
Dowel center pins



**50-712**  
Çakma başlığı  
Dowel ejector



Dowel holders  
Graft tutma uçları



**50-717**  
Tutma kolu  
Dowel handle



**50-718**  
Anahtar  
Wrench



**50-719**  
Tutma kolu  
Dowel handle  
18 cm



**50-720**  
Derinlik ölçer  
Depth gauge  
21 cm



**50-721** Ø 9.5 mm  
Koruyucu kılavuz  
Guard guide  
19 cm



**50-724 - 50-725**  
Matkap kolu  
Drill shaft  
14 cm



Matkap ucu/Drill tip

**50-722**  
Ø 13 mm  
Küçük/Small

**50-723**  
Ø 16 mm  
Büyük/Large

**50-726** Ø 10 mm  
**50-727** Ø 12 mm  
**50-728** Ø 14 mm  
**50-729** Ø 16 mm

**50-733** Ø 22 mm  
Kol içi çapı  
Handle inside diameter



**50-732** Ø 25 mm  
Matkap koruma başlığı  
Drill Guard cap  
3 mm

**50-730** Ø 13 mm  
Küçük/Small  
**50-731** Ø 16 mm  
Büyük/Large Matkap  
koruyucu Drill guard



**50-734**  
Karşı ekartör  
Counter retractor



**50-735**  
Çift hareketli karşı ekartör  
Doble hinged retractor used for longitudinal retraction



**50-736**  
Çift hareketli Servikal ekartör  
Doble hinged Cervical retractor



**50-737** 30 x 24 mm  
**50-738** 35 x 24 mm  
**50-739** 40 x 24 mm  
**50-740** 45 x 24 mm  
**50-741** 50 x 24 mm  
**50-742** 55 x 24 mm  
**50-743** 60 x 24 mm  
**50-744** 65 x 24 mm  
**50-745** 70 x 24 mm  
Titanyum orta bleydler  
Mediall blades titanium



**50-746** 30 x 24 mm  
**50-747** 35 x 24 mm  
**50-748** 40 x 24 mm  
**50-749** 45 x 24 mm  
**50-750** 50 x 24 mm  
**50-751** 55 x 24 mm  
**50-752** 60 x 24 mm  
**50-753** 65 x 24 mm  
**50-754** 70 x 24 mm  
Titanyum yan bleydler  
Lateral blades titanium



**50-755** 35 x 24 mm  
**50-756** 40 x 24 mm  
**50-757** 45 x 24 mm  
**50-758** 50 x 24 mm  
**50-759** 55 x 24 mm  
**50-760** 60 x 24 mm  
**50-761** 65 x 24 mm  
**50-762** 70 x 24 mm  
**50-763** 75 x 24 mm  
Titanyum künt bleydler  
Blunt blades titanium



**50-764** 30 x 24 mm  
**50-765** 35 x 24 mm  
**50-766** 40 x 24 mm  
**50-767** 45 x 24 mm  
**50-768** 50 x 24 mm  
**50-769** 55 x 24 mm  
**50-770** 60 x 24 mm  
**50-771** 65 x 24 mm  
**50-772** 70 x 24 mm  
Titanyum orta bleydler  
Mediall blades titanium



**50-773** 30 x 24 mm  
**50-774** 35 x 24 mm  
**50-775** 40 x 24 mm  
**50-776** 45 x 24 mm  
**50-777** 50 x 24 mm  
**50-778** 55 x 24 mm  
**50-779** 60 x 24 mm  
**50-780** 65 x 24 mm  
**50-781** 70 x 24 mm  
Titanyum yan bleydler  
Lateral blades titanium



**50-782** 35 x 24 mm  
**50-783** 40 x 24 mm  
**50-784** 45 x 24 mm  
**50-785** 50 x 24 mm  
**50-786** 55 x 24 mm  
**50-787** 60 x 24 mm  
**50-788** 65 x 24 mm  
**50-789** 70 x 24 mm  
**50-790** 75 x 24 mm  
Titanyum künt bleydler  
Blunt blades titanium



**50-791** 25 x 19 mm  
**50-792** 30 x 19 mm  
**50-793** 35 x 19 mm  
**50-794** 40 x 19 mm  
**50-795** 45 x 19 mm  
**50-796** 50 x 19 mm  
**50-797** 55 x 19 mm  
**50-798** 60 x 19 mm  
Titanyum dişli bleydler  
Teeth blades titanium



**50-799** 25 x 19 mm  
**50-800** 30 x 19 mm  
**50-801** 35 x 19 mm  
**50-802** 40 x 19 mm  
**50-803** 45 x 19 mm  
**50-804** 50 x 19 mm  
**50-805** 55 x 19 mm  
**50-806** 60 x 19 mm  
Titanyum künt bleydler  
Blunt blades titanium



**50-807**  
Bleyd tutucu elçek  
Handle for blades with side load attachment





**50-808**  
Sadece ekartör, 50-809 ile birlikte  
Retractor only, with key 50-809



**50-809**  
Tornavida/Screwdriver  
15 cm



**50-810** 20 x 35 mm  
**50-811** 20 x 40 mm  
**50-812** 20 x 45 mm  
**50-813** 20 x 55 mm  
**50-814** 20 x 65 mm  
Titanyum bleydler  
Blades titanium



**50-815** 40 x 35 mm n  
**50-816** 40 x 40 mm n  
**50-817** 40 x 45 mm n  
**50-818** 40 x 55 mm n  
**50-819** 40 x 65 mm n  
**50-820** 40 x 75 mm n  
Titanyum bleydler Blad  
titanium



**50-821** 60 x 35 mm  
**50-822** 60 x 40 mm  
**50-823** 60 x 45 mm  
**50-824** 60 x 55 mm  
**50-825** 60 x 65 mm  
**50-826** 60 x 75 mm  
**50-827** 60 x 85 mm  
Titanyum bleydler  
Blades titanium



**50-828**  
Hemi-Laminektomi huk, küçük 38 mm  
Hemi-Laminectomy hook, small 38 mm



**50-829**  
Hemi-Laminektomi huk, büyük 58 mm  
Hemi-Laminectomy hook, large 58 mm



**50-830**  
Ekartör bleydleri yerleştirme kolu  
Handle for positioning of the  
retractor blades



CLOWARD  
50-831  
15.5 cm



CLOWARD  
50-832  
13.5 cm

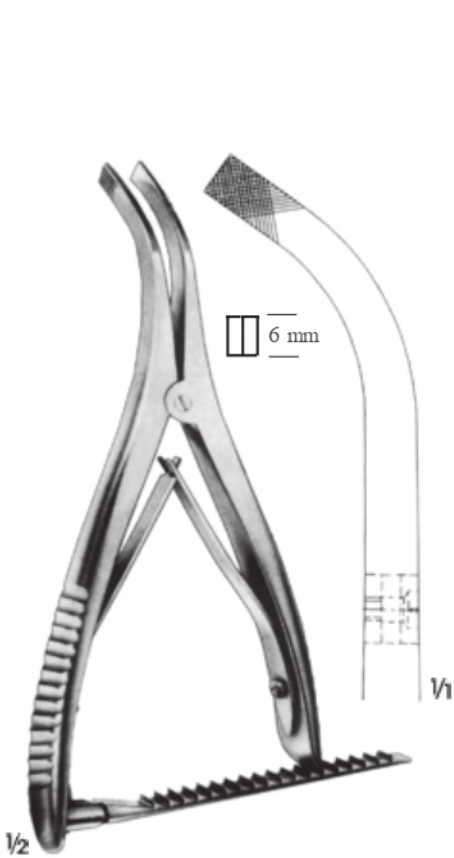

INGE  
50-833  
17 cm

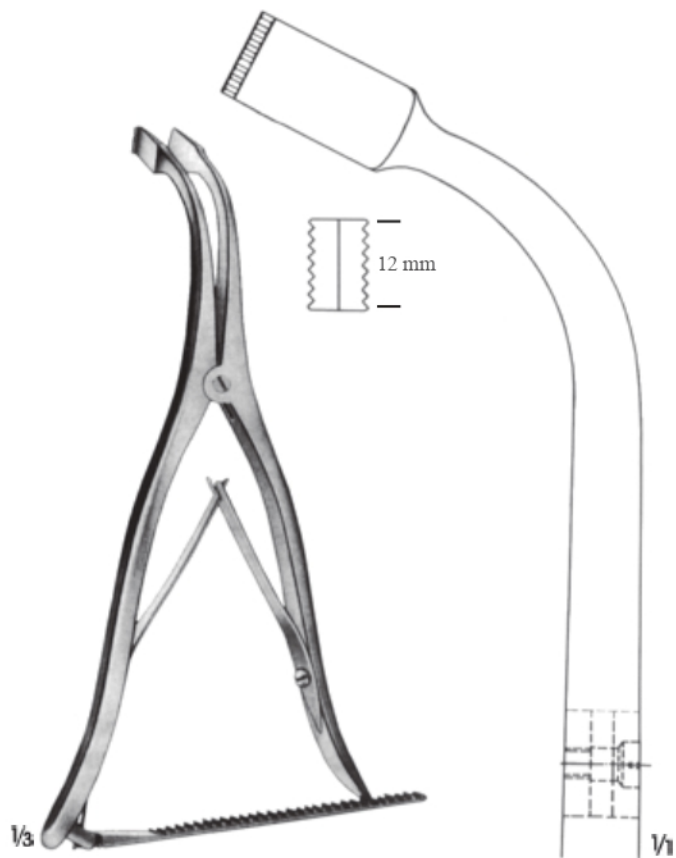

INGE  
50-834  
27.5 cm





**CRUTCHFIELD**  
**50-835**  
Çocuklar için/For children



**CRUTCHFIELD**  
**50-836**  
Orta boy/Medium size



**GARDNER-WELLS**  
**50-837**  
Maksimum açıklık (16 cm)  
Maximum opening (16 cm)



**50-838** Matkap  
ucu, büyük Drill  
point, large Ø 5  
mm



**50-839**  
Matkap ucu, küçük  
Drill point, small  
Ø 3.5 mm



**50-840**  
Anahtar/wrench

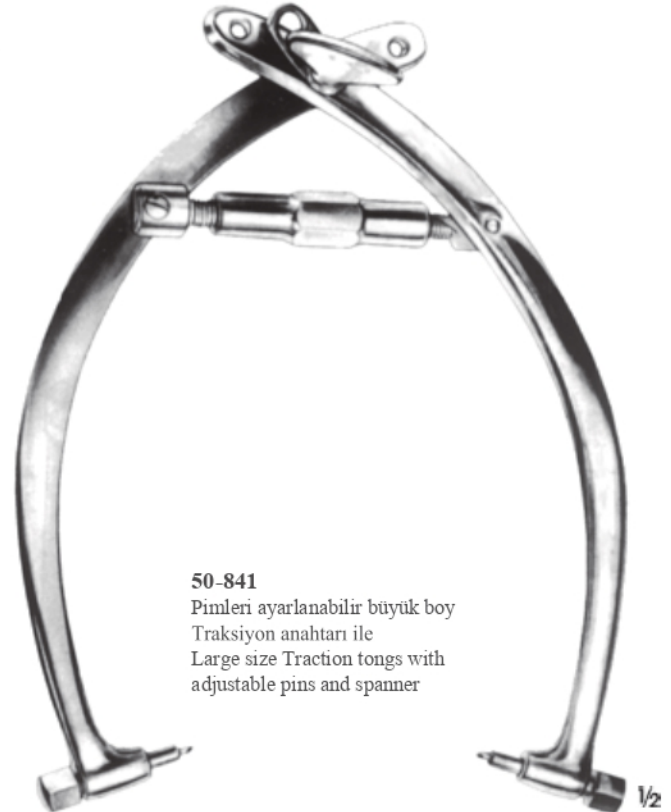

**50-841**  
Pimleri ayarlanabilir büyük boy  
Traksiyon anahtarı ile  
Large size Traction tongs with  
adjustable pins and spanner





# ASCLASS

ASCLASS CERRAHİ ALETLER İMALAT SAN. VE TİC. LTD.ŞTİ

 [asclasscerrahialetler.ve.medya](https://www.instagram.com/asclasscerrahialetler.ve.medya)  [Asclass cerrahi aletler](https://www.facebook.com/Asclass.cerrahi.aletler)  [www.asclassgrup.com](http://www.asclassgrup.com)  [info@asclassgrup.com](mailto:info@asclassgrup.com) - [asclassmedya@gmail.com](mailto:asclassmedya@gmail.com)

 Çatalarmut Mahallesi Sezgin Sokak No:7 Kat:1/2/3 İlkadım/SAMSUN