



# ASCLASS

ASCLASS CERRAHİ ALETLER İMALAT SAN. VE TİC. LTD.ŞTİ

📍 Çatalarmut Mahallesi Sezgin Sokak No:7 Kat:1/2/3 İlkadım/SAMSUN

📱 asclasscerrahialetler.ve.medya 🌐 Asclass cerrahi aletler 🌐 www.asclassgrup.com 📧 info@asclassgrup.com - asclassmedya@gmail.com



# ÜRÜN GRUPLARIMIZ

- » Genel Cerrahi
- » Beyin Cerrahi
- » Ortopedi Cerrahi
- » Göz Cerrahi
- » Kulak Burun Boğaz
- » Jinekoloji
- » Üroloji
- » Kalp Damar
- » Üniversal Ekartör Setleri
- » Laparoskopik Ekartör Setleri
- » Laparoskopik El Aletleri
- » Steril Konteynir Sistem

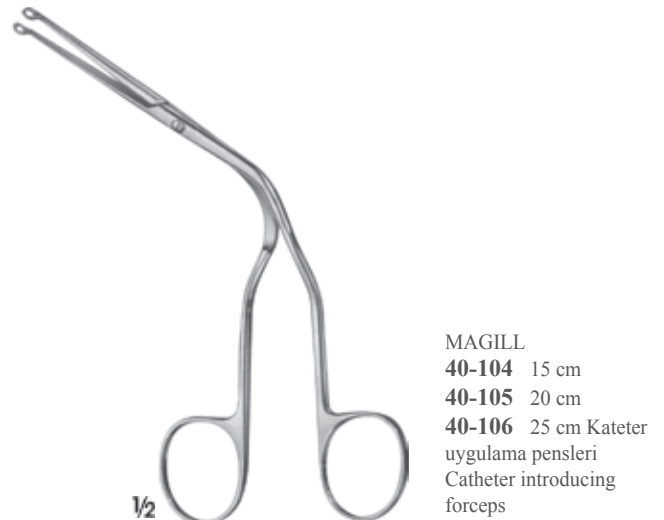
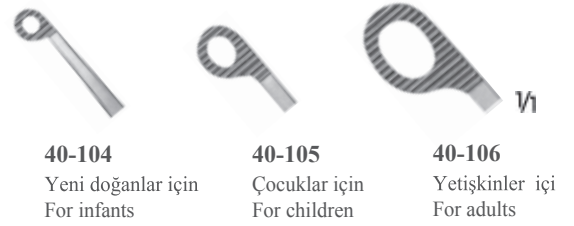
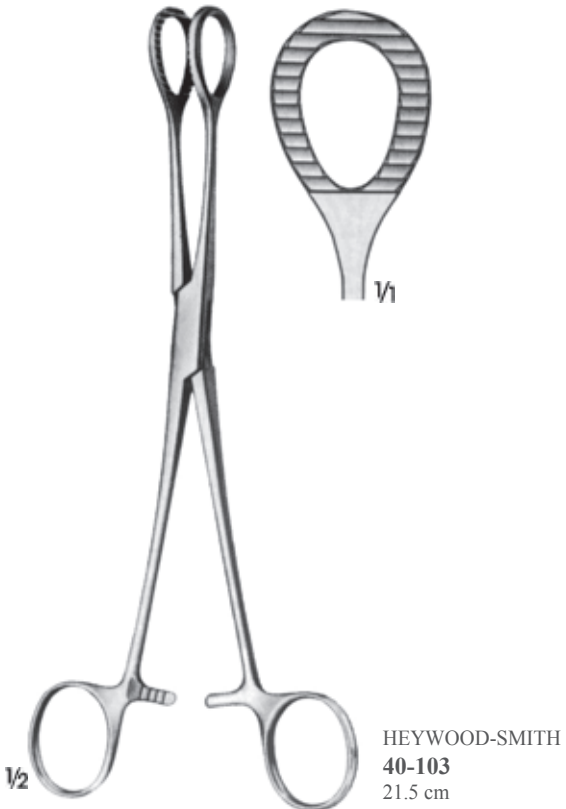
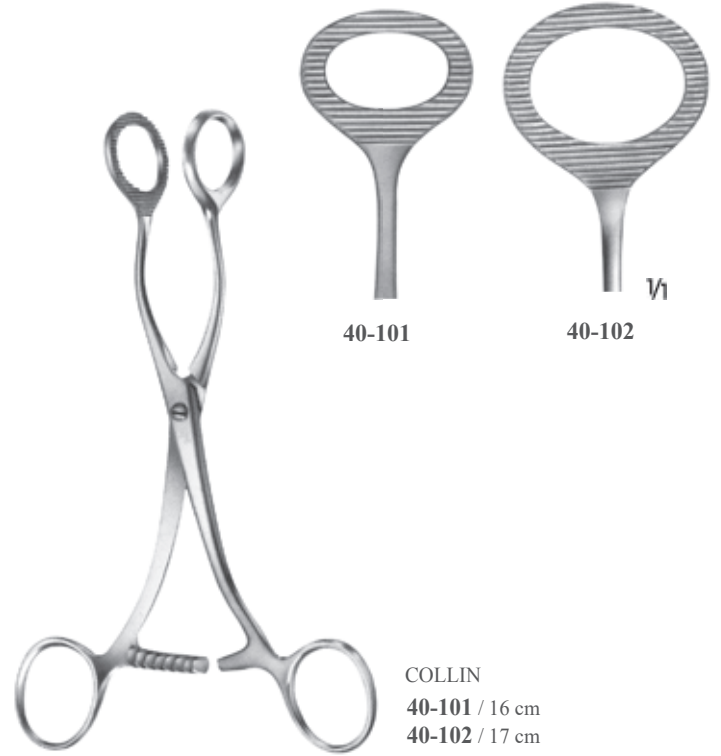
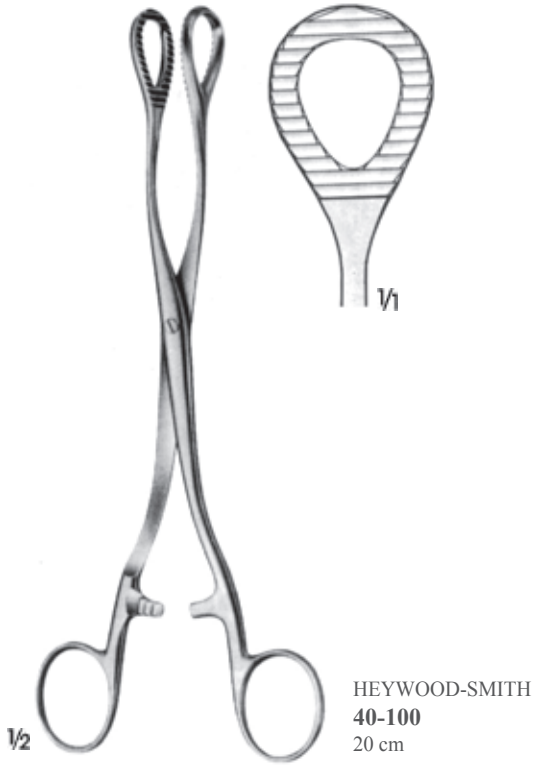


**40-**





n







**40-107**  
**40-114**  
Fig. 000  
Ø 6 mm



**40-108**  
**40-115**  
Fig. 00  
Ø 8 mm



**40-109**  
**40-116**  
Fig. 0  
Ø 10 mm



**40-110**  
**40-117**  
Fig. 1  
Ø 12 mm



**40-111**  
**40-118**  
Fig. 2  
Ø 14 mm



**40-112**  
**40-119**  
Fig. 3  
Ø 16 mm



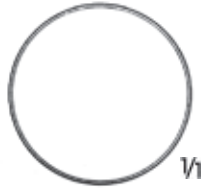
**40-113**  
**40-120**  
Fig. 4  
Ø 18 mm



**40-121**  
**40-127**  
Fig. 5  
Ø 20 mm



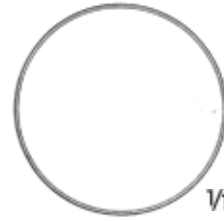
**40-122**  
**40-128**  
Fig. 6  
Ø 22 mm



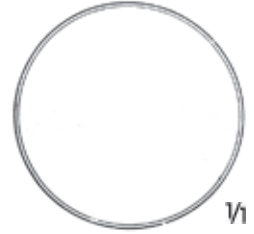
**40-123**  
**40-129**  
Fig. 7  
Ø 24 mm



**40-124**  
**40-130**  
Fig. 8  
Ø 26 mm



**40-125**  
**40-131**  
Fig. 9  
Ø 28 mm



**40-126**  
**40-132**  
Fig. 10  
Ø 30 mm



**40-128**  
Ayna sapı  
Mirror handle  
11 cm



**40-129**  
Ayna sapı  
Mirror handle  
10.5 cm



**40-107 - 40-126**  
Laringel aynalar"  
Laryngeal mirrors"12  
cm



**40-114 - 40-132**  
Altgen saplı  
laringel aynalar"  
Laryngeal mirrors with"  
hexagonal handle  
18 cm







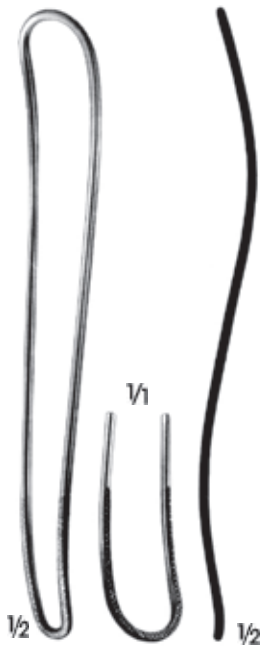
**40-133**  
14.5 cm



**40-134**  
14 cm



**BUCHWALD**  
**40-135**  
18 cm



**FRENZEL**  
**40-136**  
16.5 cm



**BRÜNINGS**  
**40-137**  
19 cm







**40-138**  
Tırnak makası  
Nail cutter  
13.5 cm



**40-139**  
Tırnak makası  
Nail cutter  
14.5 cm



**40-140 - 40-143**  
Tırnak makasları  
Nail Scissors



**40-140**  
Düz/Straight  
9 cm

**40-141**  
Eğri/Curved  
9 cm

**40-142**  
Eğri/Curved  
10 cm

**40-143**  
Eğri/Curved  
11 cm



**40-144**  
Tırnak törpüsü  
Nail file  
15 cm





40-145 -40-149  
Cetveller/Rulers

40-145	10	cm
40-146	15	cm
40-147	20	cm
40-148	30	cm
40-149	50	cm



**40-150**  
Meme markörü, dişli  
Mamilla marker, toothed  
Ø 33 mm



**40-151**  
Meme markörü, dişli  
Mamilla marker, toothed  
Ø 38 mm



**40-152**  
Meme markörü, dişli  
Mamilla marker, toothed  
Ø 42 mm



**40-153**  
Meme markörü, dişli  
Mamilla marker, toothed  
Ø 48 mm



**40-154**  
Nöroşürüji için özel kumpas  
Caliper, special for neurosurgery  
12.5 cm



**40-155**  
Kumpas/Caliper  
Ölçme 150 mm  
Measuring 150 mm  
23 cm



**40-156**  
Kumpas/Caliper  
Ölçme 100 mm  
Measuring 100 mm  
13 cm



**40-157**  
Açı ölçer  
Finger goniometer



40-162

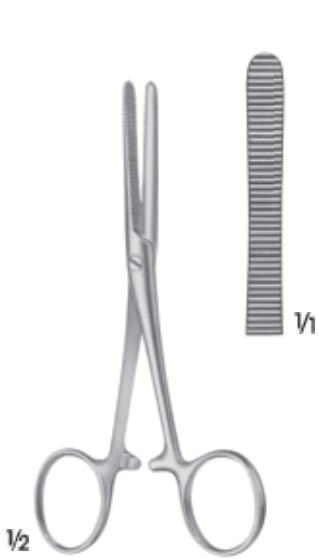
TEBBETS  
atyle







**40-158**  
Sert tüpler için, tüp klempci  
Tubing clamp forceps  
16.5 cm



PEAN  
**40-159**  
Tüp klempci  
Tubing clamp forceps  
12.5 cm



KLINIKUM BERLIN  
**40-160**  
Uzun kilit mesafeli tüp klempci  
Tubing clamp heavy pattern, long  
fore passage adjustable  
14.5 cm



SAUERBRUCH  
**40-161**  
Tutma pensci, tampon ve çamaşırlar için  
Pick-up forceps for used tampons and  
dressings  
55 cm



**40-163**  
15.5 cm



**40-164**  
18.5 cm



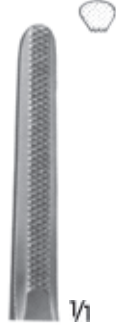
**40-165**  
20 cm



**40-163 -40-165**  
Tüp klempleri Tubing  
clamps

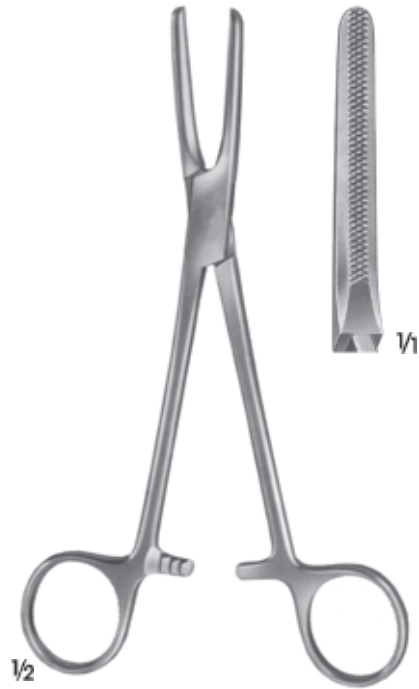


**40-166** 15 cm  
**40-167** 18 cm  
**40-168** 19 cm  
**40-169** 20 cm  
Tüp klempleri  
Tubing clamps



**1/2**  
ağız tırtıllı  
serrated jaw

**40-170**  
Tüp klempi, sert tüpler için  
Tubing clamp forceps, heavy pattern  
16.5 cm



**1/2**  
**40-171**  
Tüp klempi  
Tubing clamp  
18 cm







1/2

**40-172**  
Ağız açıcı  
Mouth gag  
12.5 cm



1/2

**FERGUSON-ACKLAND**  
**40-173**  
Ağız açıcı  
Mouth gag  
14.5 cm



1/2

**40-174**  
Ağız açıcı  
Mouth gag  
16 cm



1/2

**ROSER-KÖNIG**  
**40-175**  
Ağız açıcı  
Mouth gag  
18.5 cm



1/1

**SCHMID**  
**40-176**  
Ağız açıcı, ayarlanabilir  
Mouth opening, adjustable



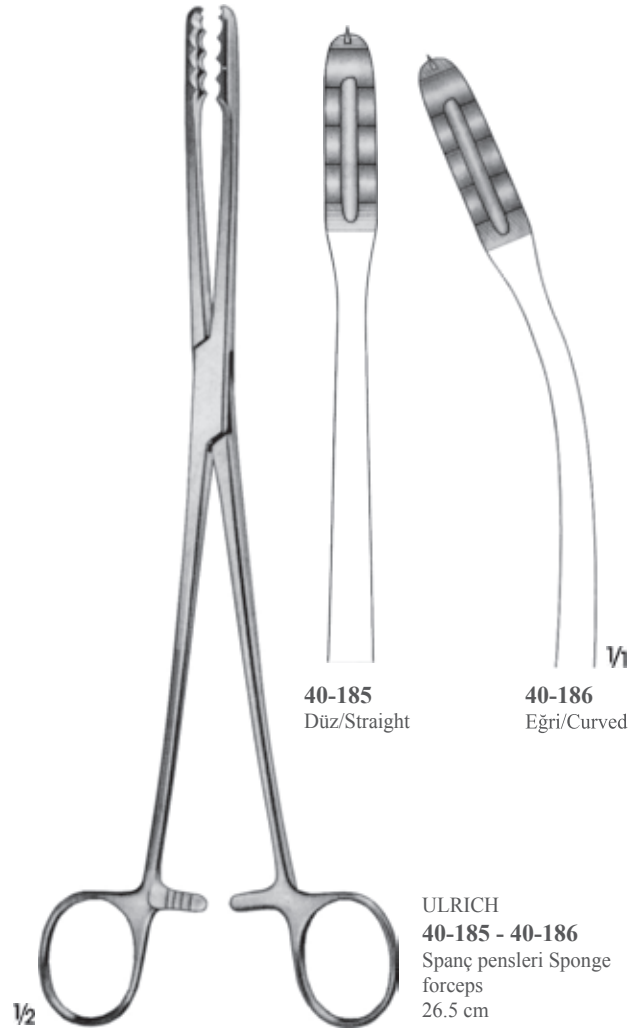
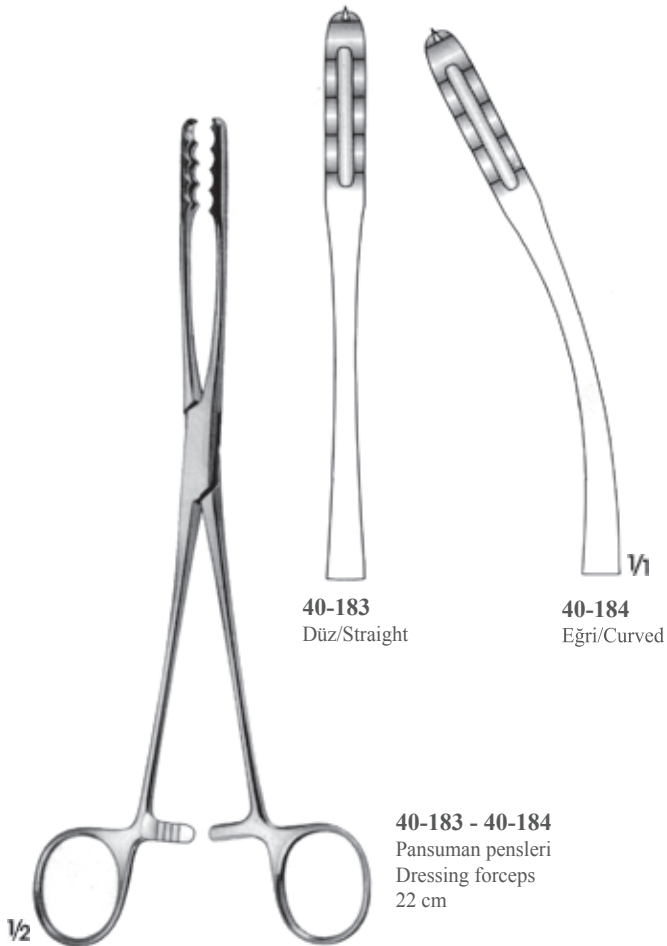
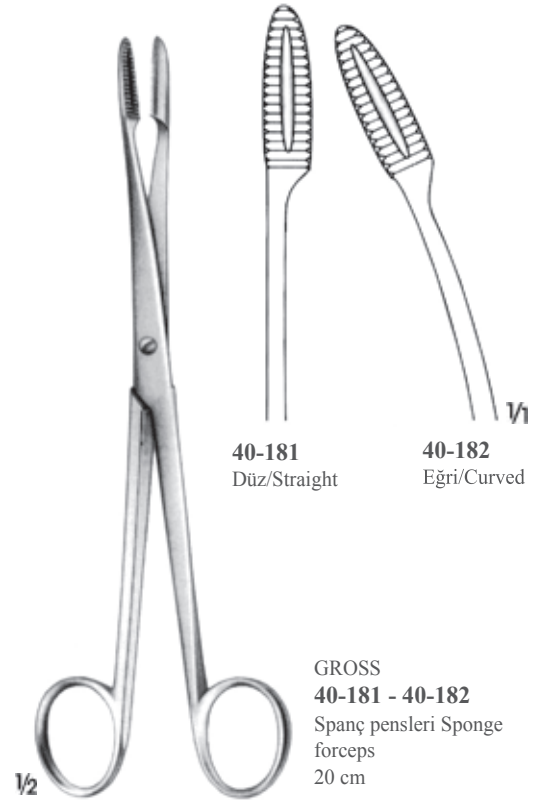
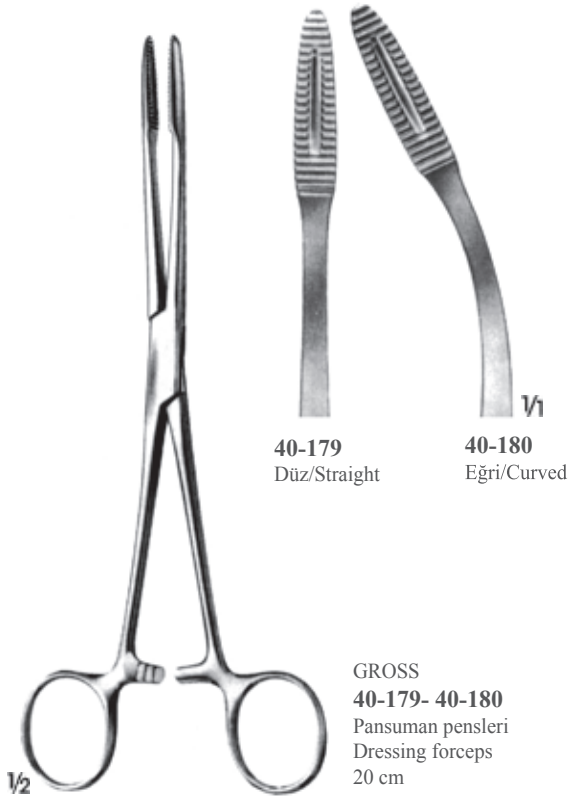
1/2

**40-177**  
Tahta ağız açıcı  
Mouth gag wooden  
14 cm



1/2

**HEISTER**  
**40-178**  
Ağız açıcı  
Mouth gag  
13 cm







**41-**





**41-100**  
No. 3  
12.5 cm



**41-101**  
No. 4  
13.5 cm



**41-102**  
No. 3  
12.5 cm



**41-103**  
No. 4  
13.5 cm



**BARRÉ**  
**41-104**  
25 cm



**BARRÉ**  
**41-105 - 41-106**  
No. 3XL  
Sol el için/For left hand  
25 cm



**41-105**



**41-106**



**41-107**  
No. 7  
16 cm



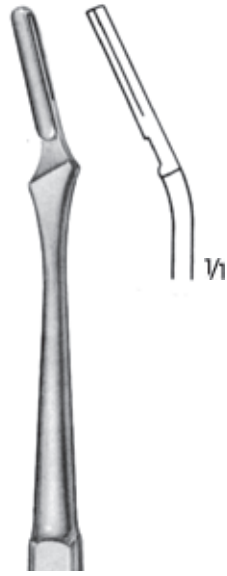




41-108  
No. 4  
22.5 cm



41-109  
No. 3  
22.5 cm



41-110



41-111  
No. 8  
13 cm



41-112  
No. 3 L  
21 cm



41-113  
No. 4 L  
21.5 cm

Sabit bar  
Bar fixed



**WATSON**  
**41-114**

Cilt nakil dermatomu, bıçaksız  
Volume transport dermatome,  
bladeless  
30 cm

Dönebilir, tırtıllı bar  
Rotable toothed bar



**BRAITHWAITE**  
**41-115**

Cilt nakil dermatomu, bıçaksız  
Volume transport dermatome,  
bladeless  
31.5 cm

Tırtıllı bar  
Knurled bar



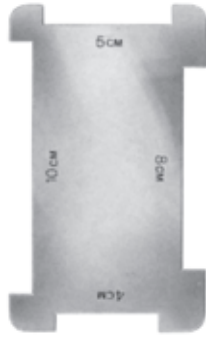
**COBBETT**  
**41-115**

Cilt nakil dermatomu, bıçaksız  
Volume transport dermatome,  
bladeless  
31.5 cm





**41-118**  
Sadece yedek bıçak  
Spare blade only



**41-119**  
Sadece cilt doğrultma  
plakası  
Skin straightening plate  
only

**SCHINIC**  
**41-117**

Dermatom 0.1mm'den 2.0 mm kadar ayarlanabilir, 1 adet değiştirilebilir **41-118** ve 2 adet **41-119** deri düzeltme plakası ile birlikte komple Dermatome, adjustable from 0.1mm to 2.0 mm complete, with 1 interchangeable blade and 2 skin straightening plates  
30 cm

1/2



1/2

**REHN**  
**41-120**  
23.5 cm



1/2

**SILVER**  
**41-121**  
Cilt nakil dermatomu, bıçaksız  
Dermatome skin transplant,  
bladeless  
19 cm



41-122  
13.5 cm



41-123  
15.5 cm



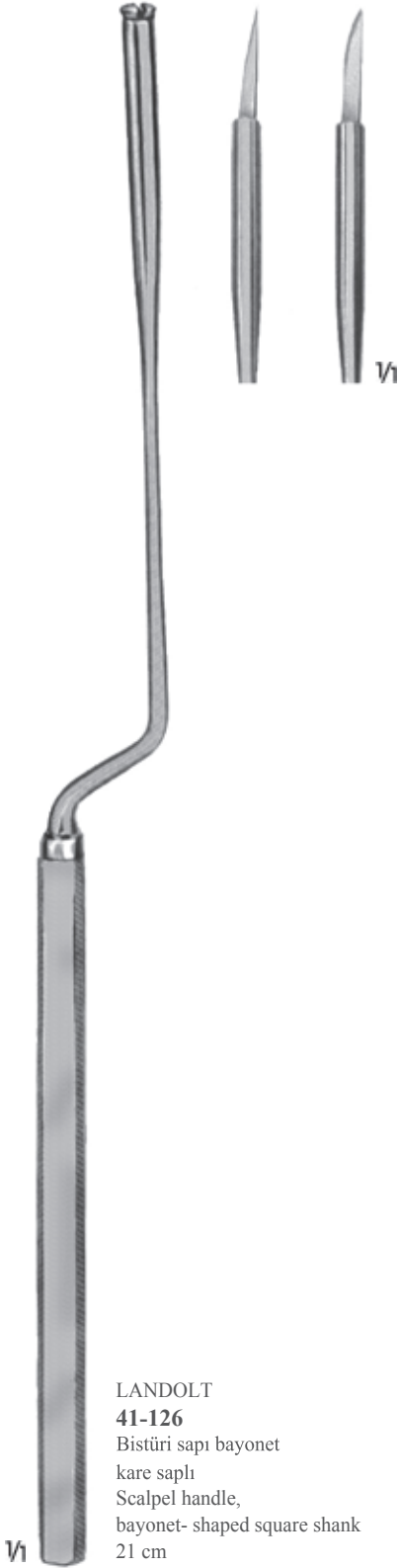
CASPAR  
41-124  
18 cm



41-125  
20 cm







LANDOLT  
**41-126**  
Bistüri sapı bayonet  
kare saplı  
Scalpel handle,  
bayonet-shaped square shank  
21 cm



**41-127**  
No. 3  
21 cm



LANDOLT  
**41-128**  
Bistüri sapı bayonet  
yuvarlak saplı  
Scalpel handle, bayo-  
net-shaped, round  
25 cm



**41-129**  
Periyost bıçak  
Periosteum knife  
Ağız uzunlukları  
Length of blade  
6.5 cm



1/2

**41-130**  
Falanks bıçak  
Phalangeal knife  
Ağız uzunlukları  
Length of blade  
10.5 cm



**41-131**

**41-132**

**LANGENBECK**  
**41-131 - 41-132**  
Rezeksiyon bıçakları  
Resection knives  
Ağız uzunlukları  
Length of blade  
5.5 cm





Çift taraflı kesme  
Double cutting

LISTON

**41-133** 13 cm

**41-134** 16 cm

**41-135** 19 cm

**41-136** 22 cm

Ampütasyon bıçakları

Amputation knives

Ağız uzunlukları

Length of blade

12 cm

1/2



Çift taraflı kesme  
Double cutting

CATLIN

**41-137**

Ampütasyon bıçak

Amputation knife

Ağız Uzunlukları

Length of blade

16 cm

1/2



Çift taraflı kesme  
Double cutting

**41-138**

İnterosseöz bıçak

Interosseous knife

Ağız uzunlukları

Length of blade

11 cm

1/2



LANGENBECK

**41-139**

Kanat bıçak

Flap knife

Ağız uzunlukları

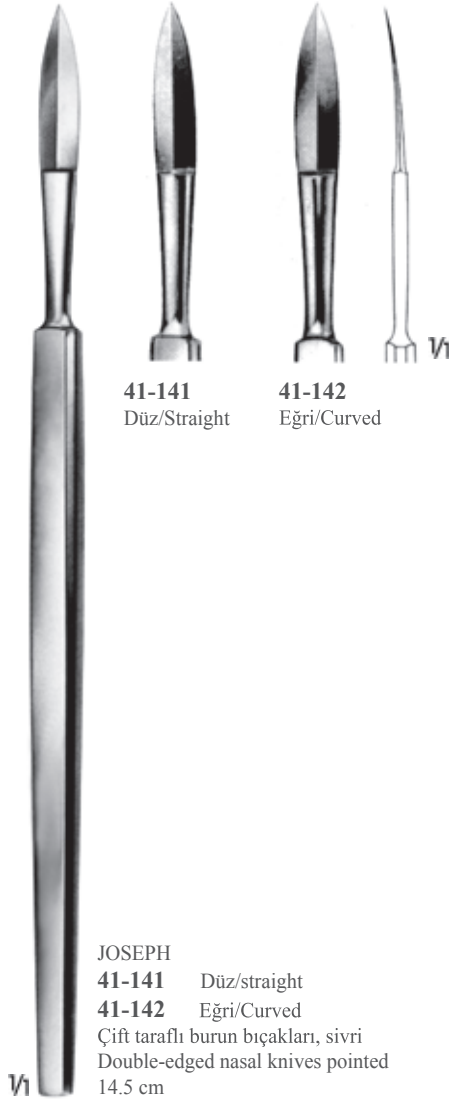
Length of blade

12 cm

1/2



MASING  
**41-140** Eğri/sivri  
Kıkırdak kesme bıçağı  
Cartilage slitting knife,  
curved blade, pointed  
13 cm



JOSEPH  
**41-141** Düz/straight  
**41-142** Eğri/Curved  
Çift taraflı burun bıçakları, sivri  
Double-edged nasal knives pointed  
14.5 cm



SIMON  
**41-143 - 41-144**  
Fistül bıçakları  
Fistula knives  
20 cm



ULRICH  
**41-145**  
Fistül bıçağı  
Fistula knife  
22.5 cm







V<sub>1</sub>

41-146 - 41-155



rV

41-146  
14 cm



41-147  
15 cm



41-148  
15.5 cm



41-149  
16.5 cm



41-150  
17 cm



41-151  
17.5 cm



41-152  
18 cm



41-153  
18 cm

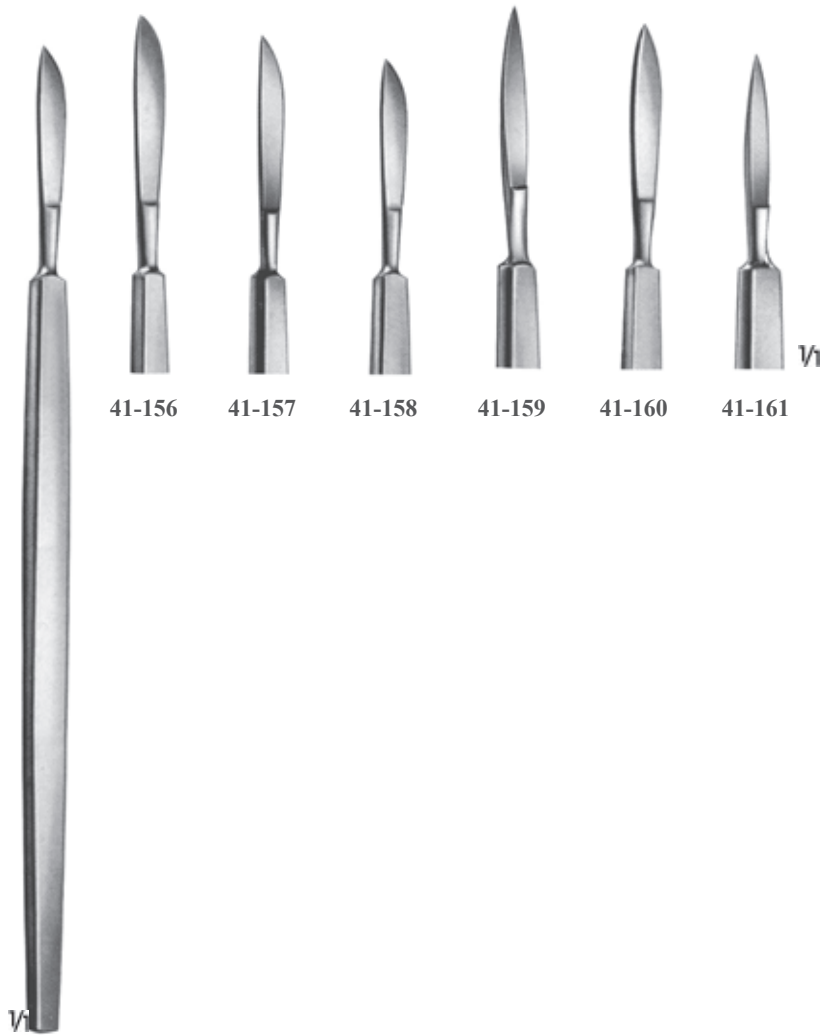


41-154  
16 cm



rV

41-155  
Tenotom/Tenotome  
17 cm



41-156 41-157 41-158 41-159 41-160 41-161

41-156 - 41-161  
13 cm



BERGMANN  
41-162  
14 cm





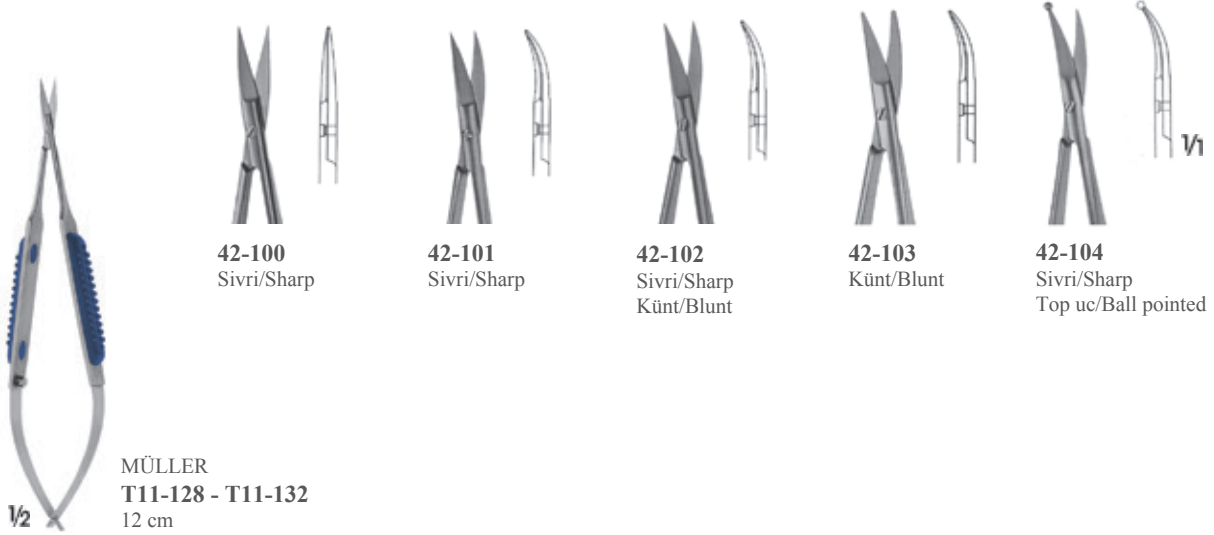
**42-**

Kavrama yüzeyini artıran hafif plastik tutamak :

- Kramp oluşturmeyen, doğal tutma pozisyonu ve duyarlılık sağlar.
- Yuvarlak tutma kesiti aletin kolay ve düzgün rotasyonunu sağlar. Böylelikle uygulama ve çalışma alanı genişler.
- Pimli tutma profili güvenli tutmayı garanti eder.
- Ergonomik, hafif plastik sap yorulmadan optimum kullanım sağlar.

Lightweigh plastic handles to increase grip surface :

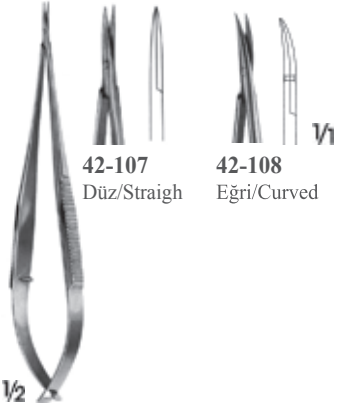
- Provides cramp free, natural holding positions and sensitivity
- Round cross-section of the instrument provides an easy and smooth rotation. Expands the working and application area.
- Retention profile with pin ensures safe gripping.
- Ergonomic, light weight plastic handle provides fatigue free, optimal usage.





Düz Saplar ve çapraz tırtıl :  
Sağlam kavrama özelliği sağlar.

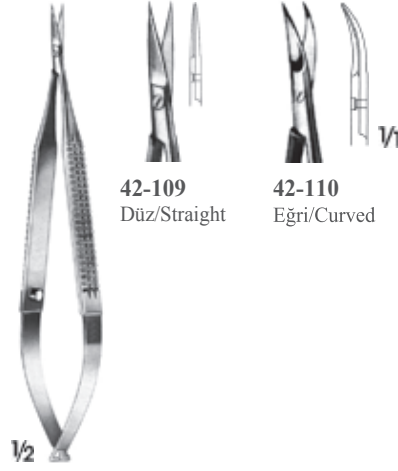
Flat handles and cross serration:  
Provides a solid grip.



42-107  
Düz/Straigh

42-108  
Eğri/Curved

42-107 - 42-108  
Göz makasları/Eye scissors  
10.5 cm



42-109  
Düz/Straight

42-110  
Eğri/Curved

42-109 - 42-110  
Mikro makaslar/Micro scissors  
12 cm



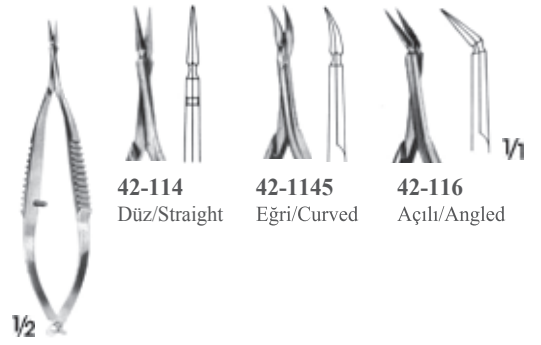
VANNAS  
42-111  
Düz/Straight  
Mikro makas/Micro scissors  
12 cm



VANNAS  
42-112  
Mikro makas/Micro scissors  
12 cm



MC CLURE  
42-113  
Düz/Straight  
Göz makası/Eye scissors  
9.5 cm



42-114  
Düz/Straight

42-115  
Eğri/Curved

42-116  
Açılı/Angled

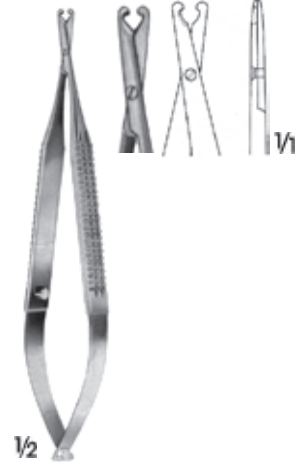
VANNAS  
42-114 - 42-116  
Hassas/Delicate  
8.5 cm



VANNAS  
42-117  
Mikro makas/Micro scissors  
Düz açılı/Angled on flat  
12 cm



NOYES  
42-118  
Göz makası/Eye scissors  
Düz/Straight  
12.5 cm



42-119  
Damar ucunu pürüzsüzleştirmek  
için damar makası  
Vein scissors for roughening  
Vessel ends  
13 cm



WECKER  
42-120 Uçları sivri/Pointed-pointed  
42-121 Sivri, künt, sağ/Pointed-blunt, right  
42-122 Sivri, künt, sol/Pointed-blunt, left  
42-123 Uçları künt/Blunt-blunt  
Göz makasları/Eye scissors  
11 cm

1/1



CASTROVIEJO  
42-124 - 42-125  
Göz makasları/Eye Scissors  
9.5 cm



42-124  
Açılı/Angled



42-125  
Eğri/Curved



CASTROVIEJO  
42-125  
Göz makasları/Eye scissors  
11 cm

42-126



Yuvarlak Saplar

- Parmaklar arasında istenildiği şekilde döndürmeye izin verir.
- Sağlam veya oyulmuş saplardan dolayı her bir alette optimum denge sağlar.

Round Handle

- Allows rotation between the fingers as required
- Due to carved and strong handle, each instrument provides optimum balance.



1/2

**42-127**  
Mikro ligatür makası  
Micro ligature scissor  
18 cm



1/1

Sivri/Sharp  
1 bleyd tırtıllı/1 blade serrated

Sütür 6-0 ve daha küçükler için - 8-0 ve daha küçükler için  
For suture material 6-0 and smaller - 8-0 and smaller



1/2

**T11-153 - T11-155**  
Mikro makaslar  
Micro scissors  
18 cm



**42-128**  
Sivri/Sharp



**42-129**  
Sivri/Sharp



1/1

**42-130**  
1 bleydi küre uclu  
1 blade probe pointed



1/2

**42-131 - 42-133**  
16.5 cm



**42-131**  
Eğri/Curved  
Ultra hasas bleyd  
Ultra delicate blade



**42-132**  
Düz/Straight  
Hassas bleyd  
Delicate blade



1/1

**42-133**  
Eğri/Curved  
Hassas bleyd  
Delicate blade



1/2

**42-133 - 42-135**  
14.5 cm



**42-133**  
Düz/Straigh



**42-134**  
Eğri/Curved



1/1

**42-135**  
Eğri/Curved  
Mikro diseksiyon makası  
Micro dissecting scissors

Düz Saplı ve Çapraz Tırtıllı Mikro Makaslar(Yaylı Tip)  
M.Scissors (Spring Type) with Flat Handles and Cross-Serration

Düz Saplar ve çapraz tırtıl :  
Sağlam kavrama özelliği sağlar.

Flat handles and cross serration:  
Provides a solid grip.



1/2

42-136 - 42-137  
16 cm



42-136  
Düz/Straight



42-137  
Eğri/Curved

1/1



1/2

VANNAS  
42-138 - 42-139  
16 cm



42-138  
Düz/Straight



42-139  
Eğri/Curved

1/1



1/2

MILLESİ  
42-140 - 42-141  
Çift ağız tırtıllı  
Both jaws serrated  
16 cm



42-140  
Düz/Straight



42-141  
Eğri/Curved

1/1



1/2

42-143 - 42-144  
18.5 cm



YASARGİL  
42-143  
Düz/Straight



JACOBSON  
42-144  
Eğri/Curved

1/1



1/2

42-145 - 42-146  
Düz/Straight  
16.5 cm



42-145  
Ultra hassas bleyd  
Ultra delicate blade



42-146  
Hassas bleyd  
Delicate blade

1/1



1/2

42-147 - 42-148  
Eğri/Curved  
16.5 cm



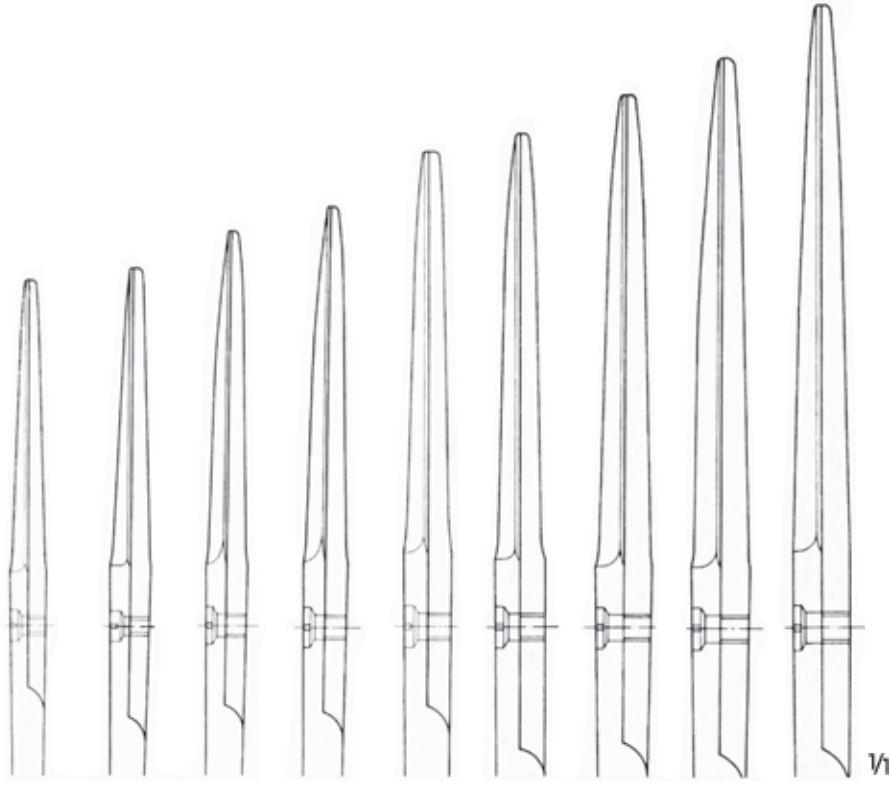
42-147  
Ultra hassas bleyd  
Ultra delicate blade



42-148  
Hassas bleyd  
Delicate blade

1/1





**42-150** 11.5 cm    **42-151** 13 cm    **42-152** 14.5 cm    **42-153** 15 cm    **42-154** 16.5 cm    **42-155** 17.5 cm    **42-156** 18.5 cm    **42-157** 20 cm    **42-158** 25 cm

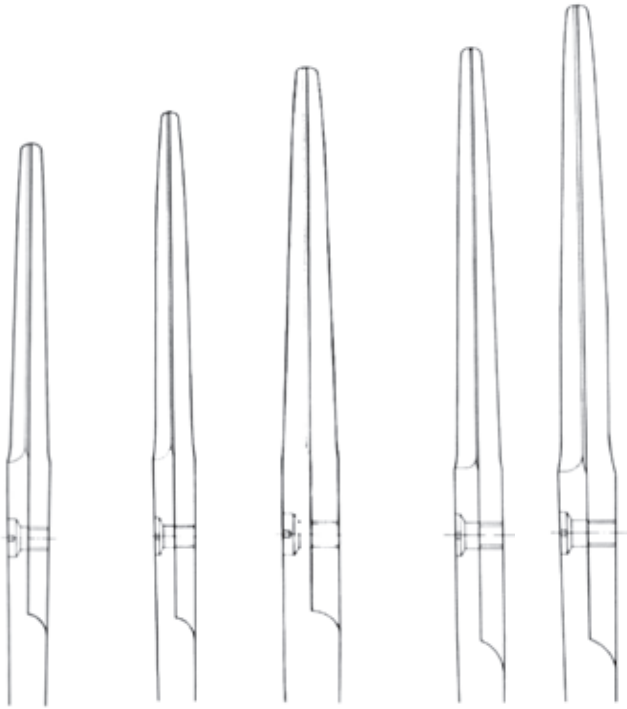


**42-150 - 42-157**  
Standart model/Standart patterns  
Sivri-Küntt/Sharp-Blunt  
Düz/Straight



**42-159 - 42-165**  
Standart model/Standart patterns  
Sivri-Küntt/Sharp-Blunt  
Eğri/ Curved

**42-159** 11.5 cm    **42-160** 13 cm    **42-161** 14.5 cm    **42-162** 15 cm    **42-163** 16.5 cm    **42-164** 17.5 cm    **42-165** 18.5 cm



**42-166** 13 cm  
**42-167** 14.5 cm  
**42-168** 15 cm  
**42-169** 16.5 cm  
**42-170** 17.5 cm

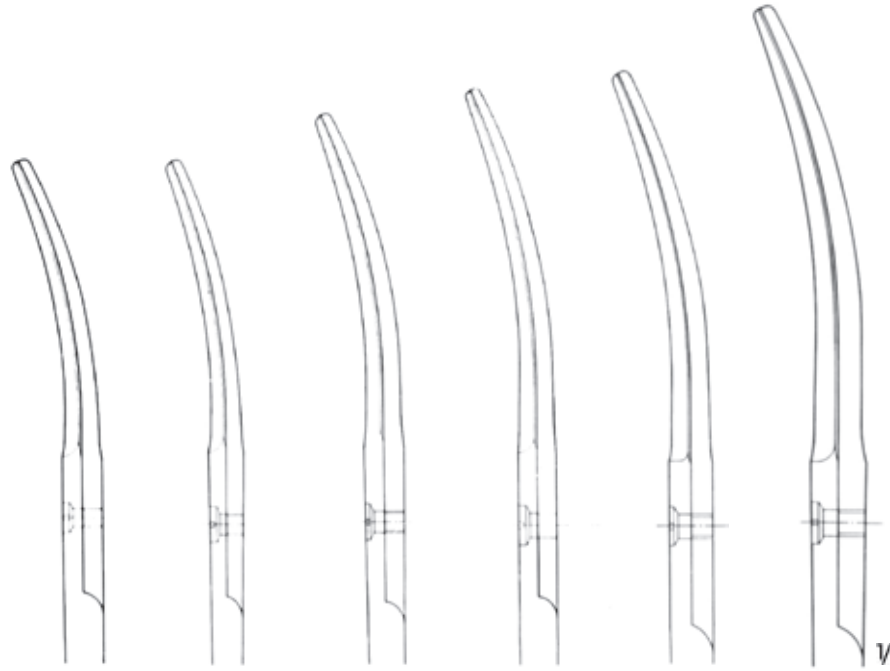
Vi



**442-166- 42-170**  
 Standart model/Standart patterns  
 Künt/Blunt  
 Düz/Straight



**COOPER**  
**42-171 - 42-176**  
 Standart model/Standart patterns  
 Künt/Blunt  
 Eğri/Curved

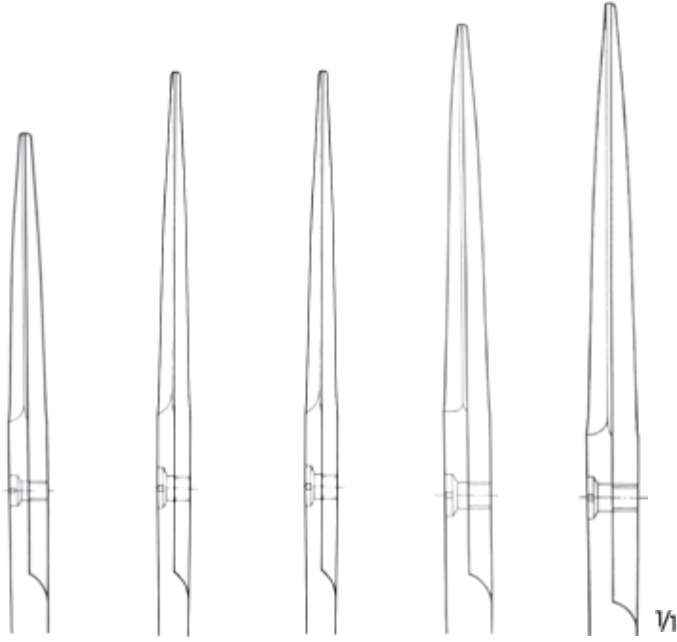


**42-171** 11.5 cm  
**42-172** 13 cm  
**42-173** 14.5 cm  
**42-174** 15 cm  
**42-175** 16.5 cm  
**42-176** 17.5 cm

Vi



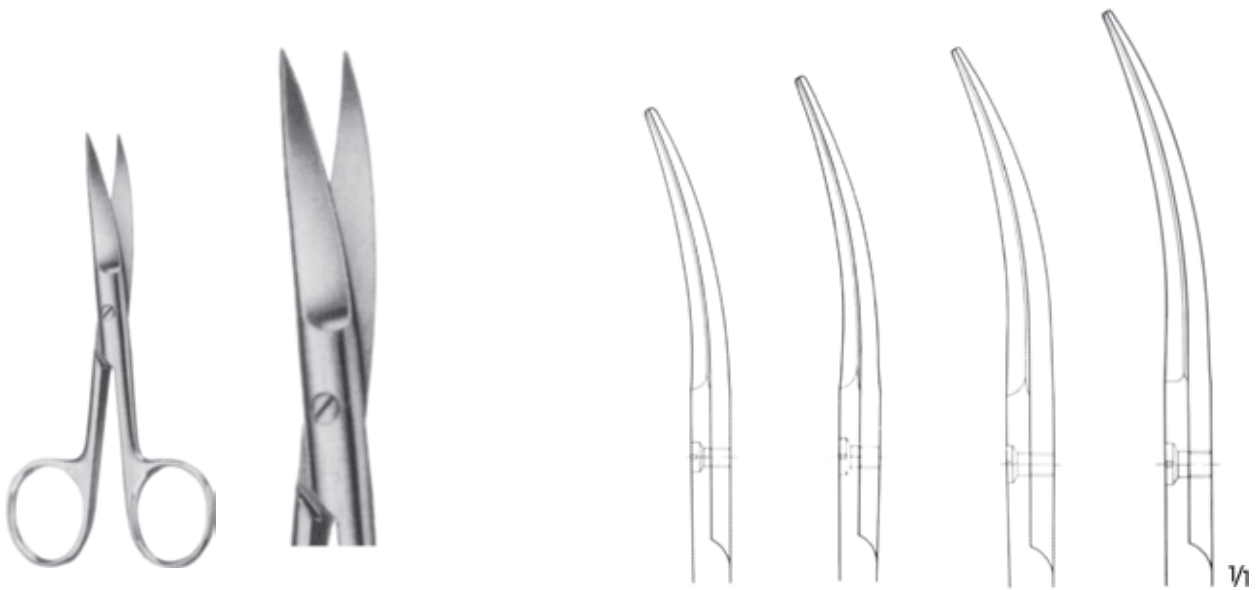




**42-177** 11.5 cm  
**42-178** 13 cm  
**42-179** 14.5 cm  
**42-180** 15 cm  
**42-181** 16,5 cm



**42-177 - 42-181**  
Standart model/Standart patterns  
Sivri/Sharp  
Düz/Straight



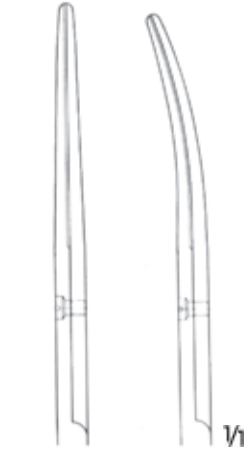
**42-182 - 42-185**  
Standart model/Standart patterns  
Sivri/Sharp  
Eğri/Curved

**42-182** 11.5 cm  
**42-183** 13 cm  
**42-184** 14.5 cm  
**42-185** 15 cm



1/2

**BABY-METZENBAUM**  
**42-186 - 42-187**  
Diseksiyon makasları  
Dissecting scissors  
14.5 cm



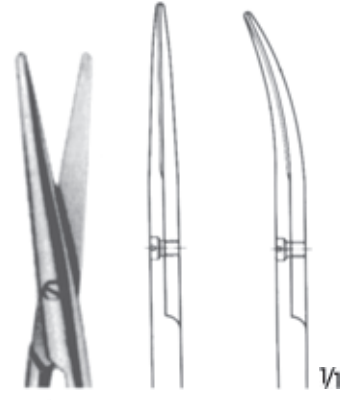
**42-186**  
Düz/Straight

**42-187**  
Eğri/Curved



1/2

**COTTLE-KNAPP**  
**42-188 - 42-189**  
Plastik cerrahi makaslar  
Scissors for plastic surgery  
10.5 cm



**42-188**  
Düz/Straight  
Künt/Blunt

**42-189**  
Eğri/Curved  
Künt/Blunt



1/2

**TÖNNIS-ADSON**  
**42-190 - 42-191**  
Diseksiyon makasları  
Dissecting scissors  
17.5 cm



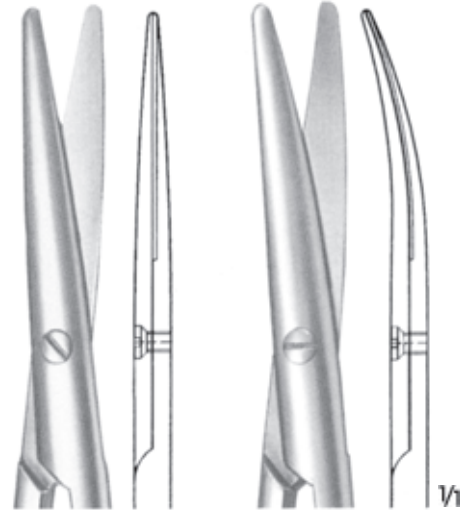
**42-190**  
Çok hassas  
Very delicate

**42-191**  
Hassas  
Delicate



1/2

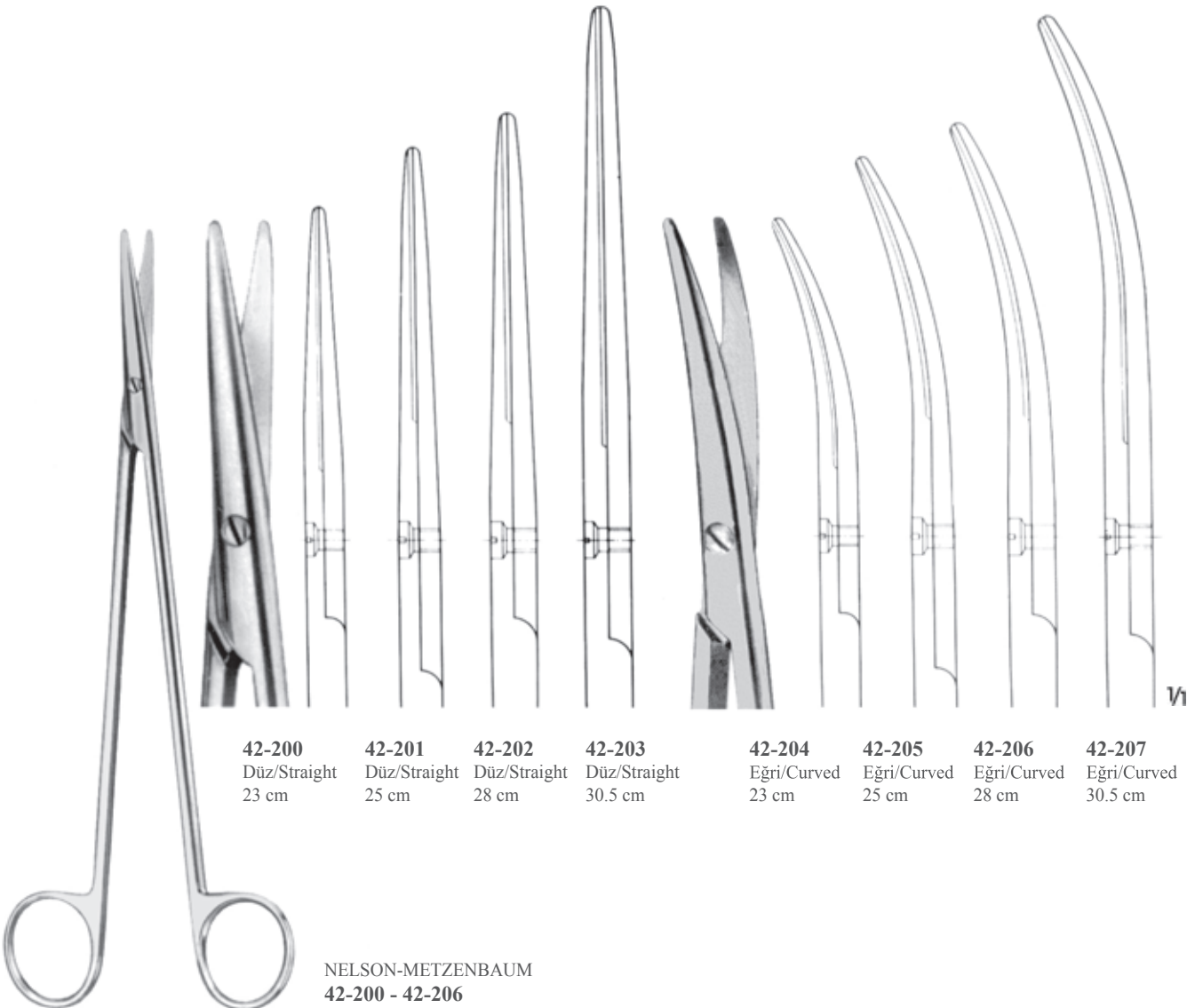
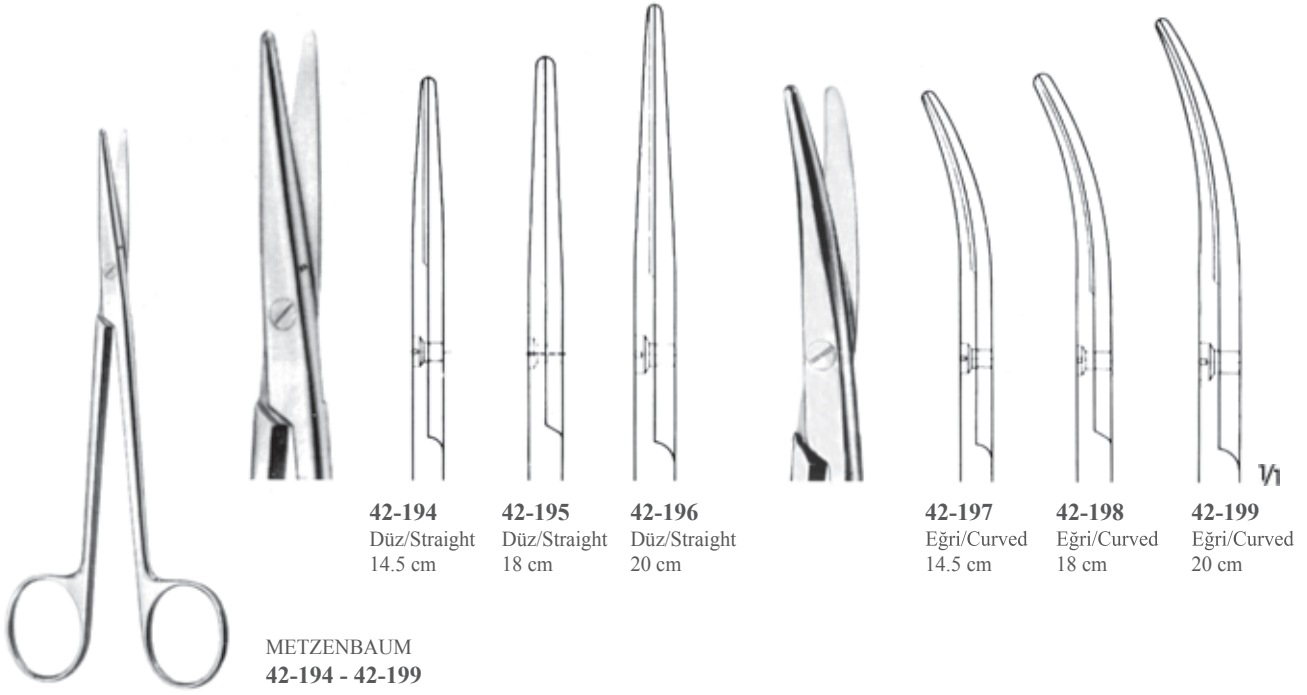
**METZENBAUM**  
**42-192 - 42-193**  
Diseksiyon makasları  
Dissecting scissors

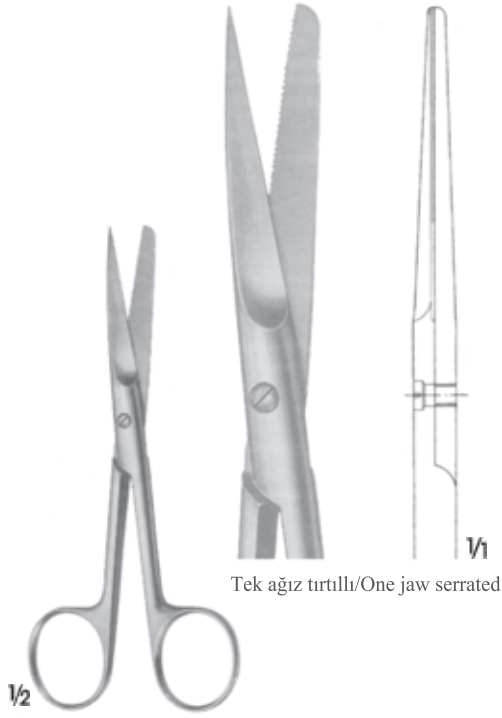


**42-192**  
Düz/Straight  
20 cm

**42-193**  
Eğri/Curved  
16 cm



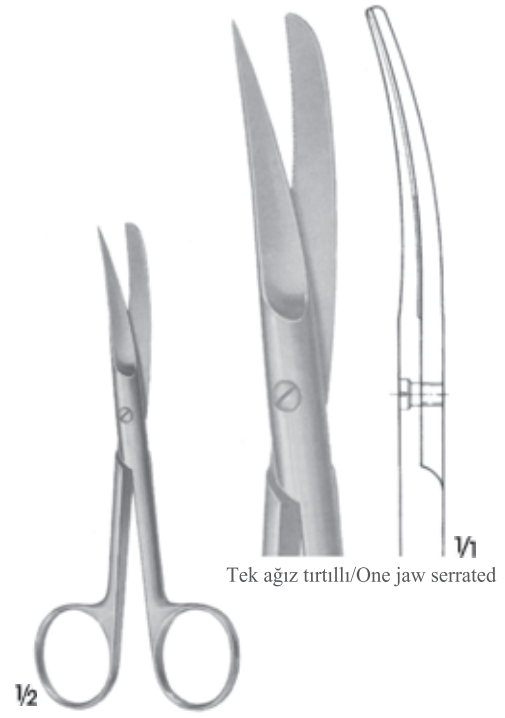




Tek ağız tırtıllı/One jaw serrated

**42-208**

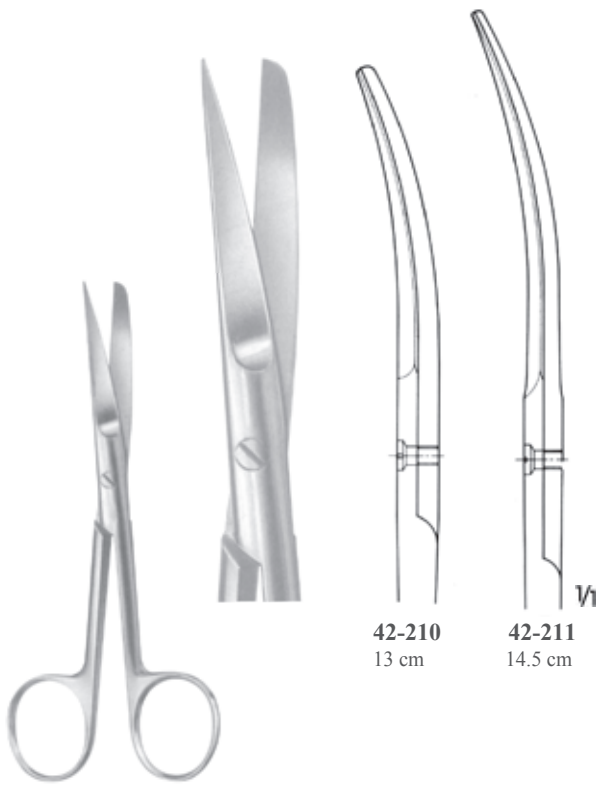
Yara kenar makası/ Scissors for wound edges  
Sivri-Küntt/Sharp-Blunt  
Düz/Straight  
13 cm



Tek ağız tırtıllı/One jaw serrated

**42-209**

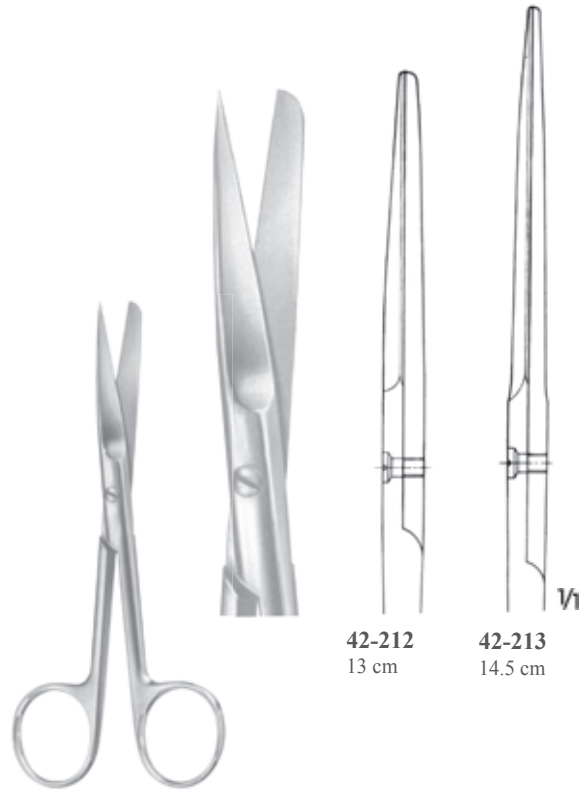
Yara kenar makası/ Scissors for wound edges  
Sivri-Küntt/Sharp-Blunt  
Eğri/Curved  
13 cm



**42-210**  
13 cm

**42-211**  
14.5 cm

**42-210 - 42-211**  
Narin model/Slender patterns  
Sivri-Küntt/Sharp-Blunt  
Eğri/Curved

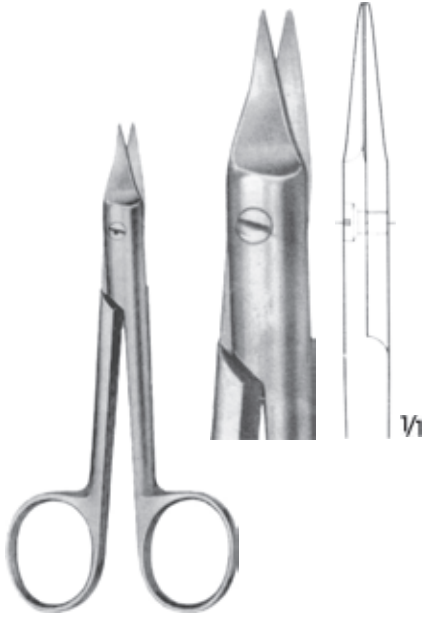


**42-212**  
13 cm

**42-213**  
14.5 cm

**42-212 - 42-213** Narin  
model/Slender patterns Sivri-  
Küntt/Sharp-Blunt Düz/  
Straight





**SYSTRUNK**  
**42-214**  
Sert doku makası/Nail splitting scissors  
13 cm



**42-215 - 42-217**  
Inzisyon makasları/Incision scissors  
Düz/ Straight

**42-215**  
13 cm

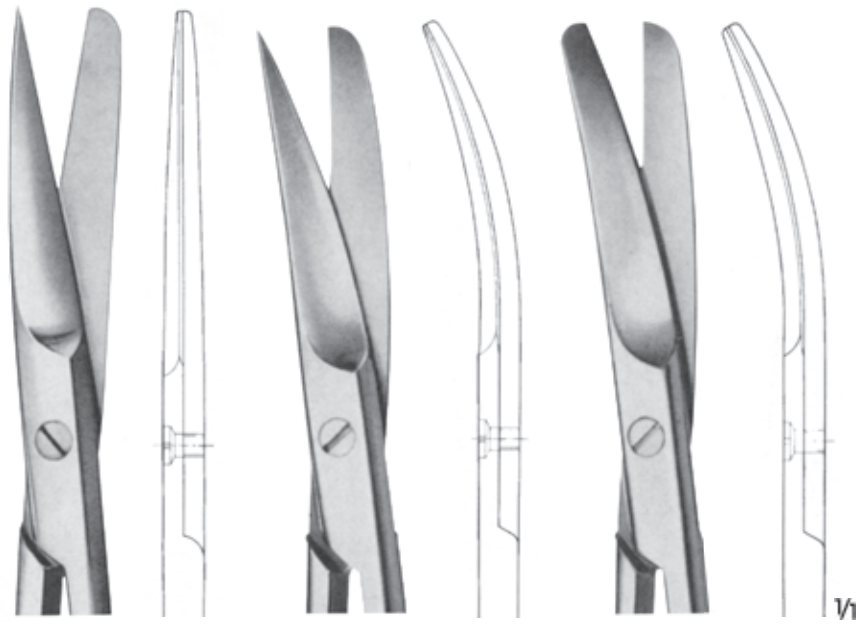
**42-216**  
14.5 cm

**42-217**  
16.5 cm

1/2



**DEEVER**  
**42-218- 42-220**  
Cerrahi makaslar/Surgical scissors  
14.5 cm

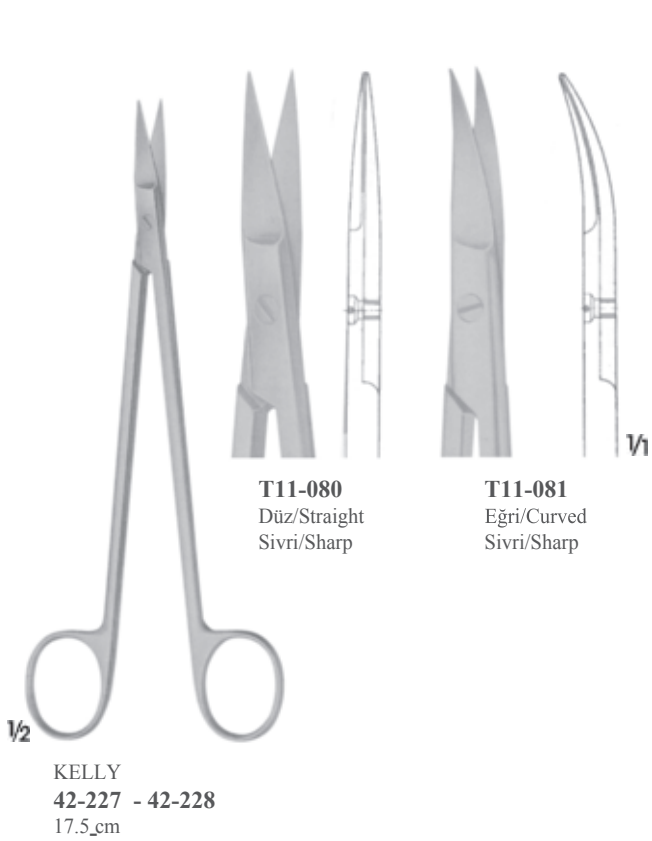
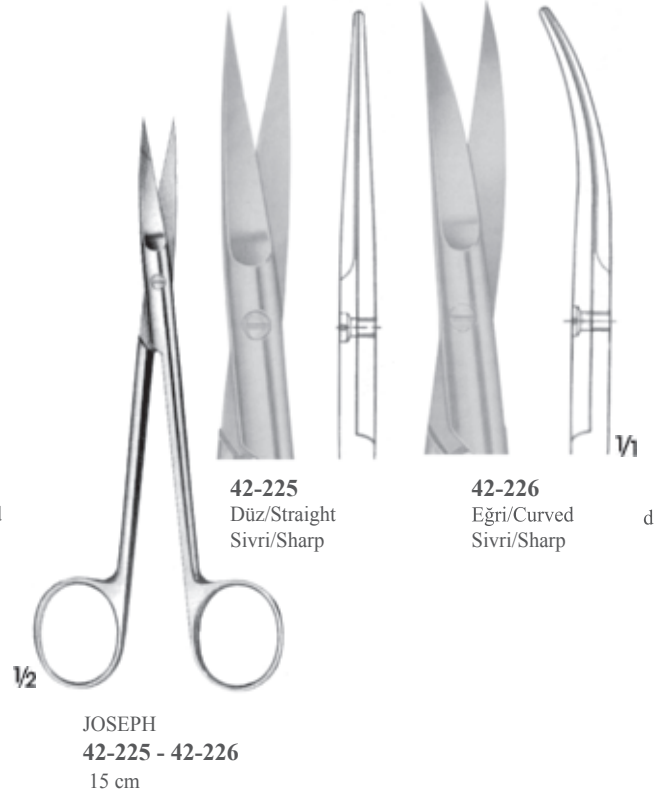
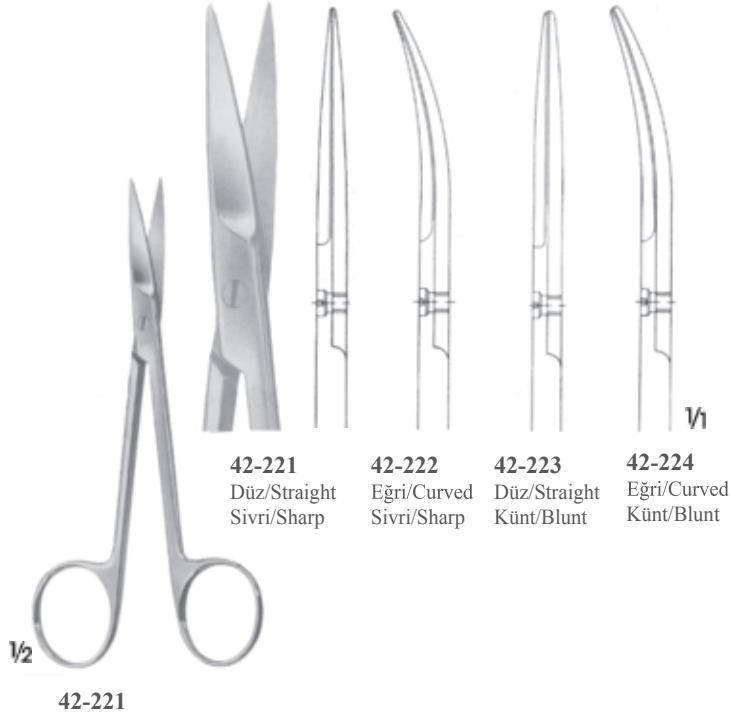


**42-218**  
Sivri/Sharf  
Künt/Blunt

**42-219**  
Sivri/Sharf  
Künt/Blunt

**42-220**  
Künt/Blunt

1/2



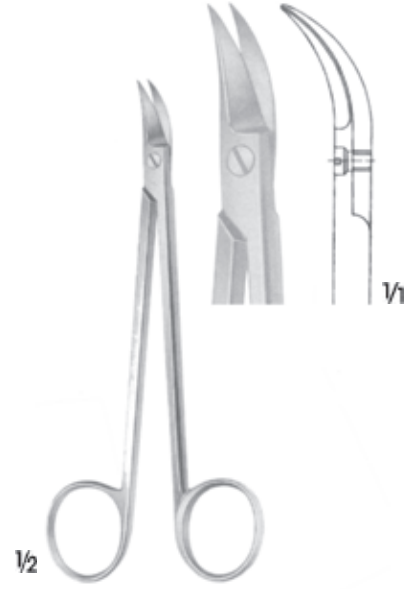




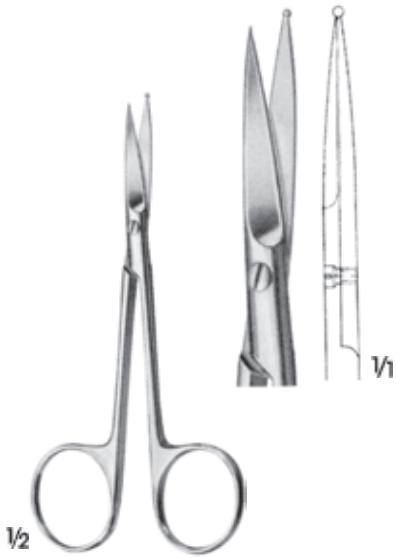
**PERWITZSCHKY**  
**42-232**  
1 bleydi küre uclu eğri,  
With 1 probe pointed blade, curved to side  
10 cm



**CHADWICK**  
**42-233**  
11.5 cm



**QUINBY**  
**42-234**  
13 cm



**42-235**  
1 bleydi küre uclu  
With 1 probe pointed blade  
12 cm



**42-236**  
11 cm



**42-237**  
Yana doğru açılı  
Angled to side  
11.5 cm



**42-238**  
Tek ağız tırtıllı, hassas  
One jaw fine serrated  
13 cm



**LA GRANGE**  
**42-239**  
Tek ağız tırtıllı  
One jaw serrated  
11 cm



**42-240**  
Tek ağız tırtıllı, yana açılı  
Angled on flat, one jaw serrated  
12.5 cm

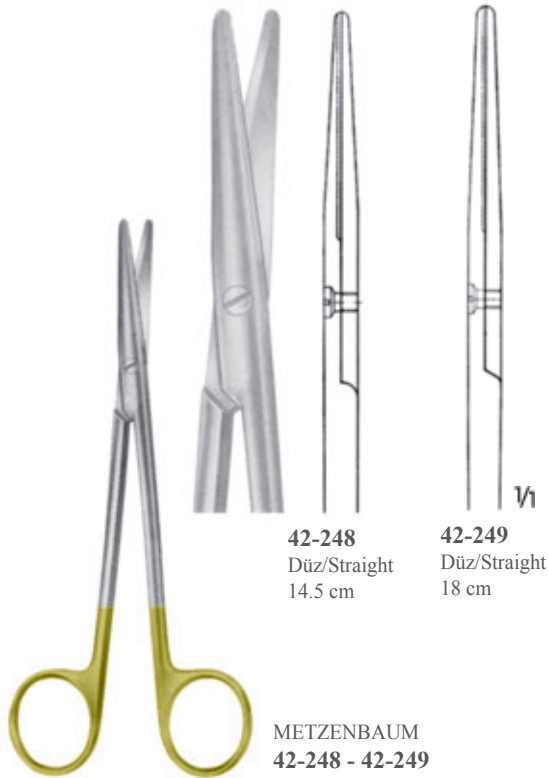
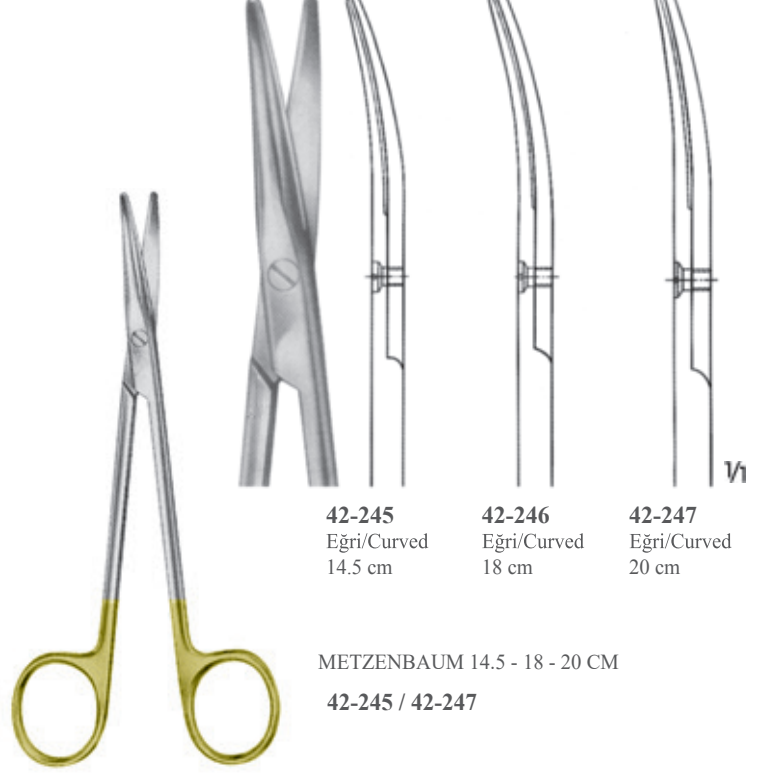


**42-241**  
1 ucu problu  
With 1 probe pointed blade  
14.5 cm



**LOCKLIN**  
**42-242**  
Tek ağız tırtıllı, yana açılı  
Angled to side, one jaw serrated  
15.5 cm







*FineCut*



V1



**42-252**  
Ligatür makası/Ligature scissors  
Eğri/Curved  
11 cm

V2

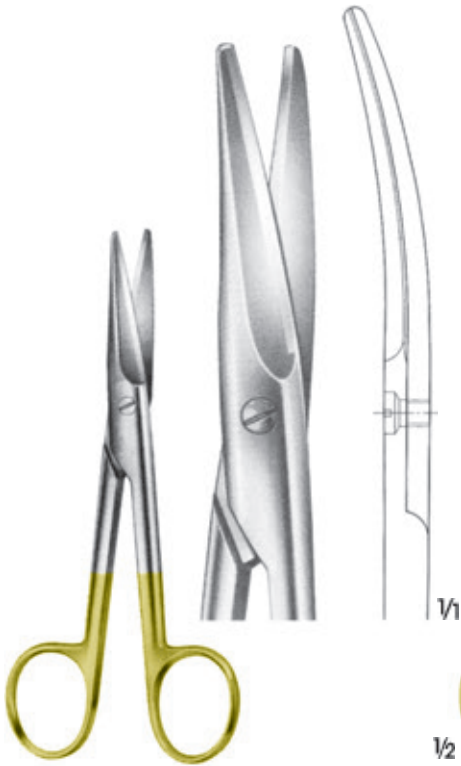


V1

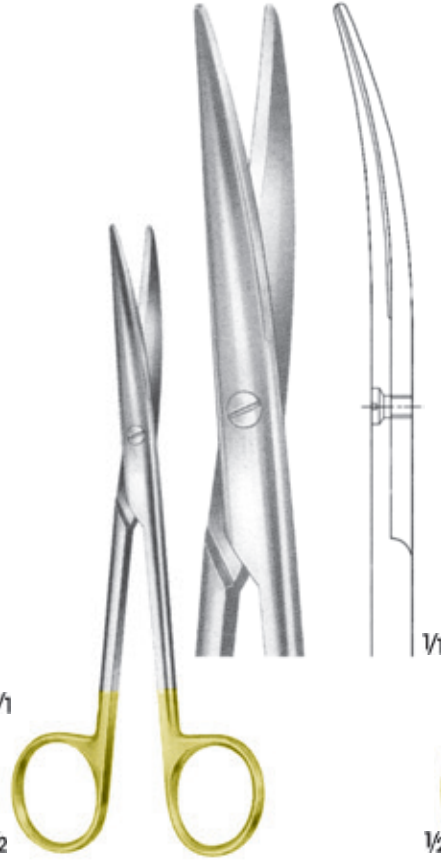


**42-253**  
Cerrahi makas/Surgical Scissors  
14.5 cm

V2

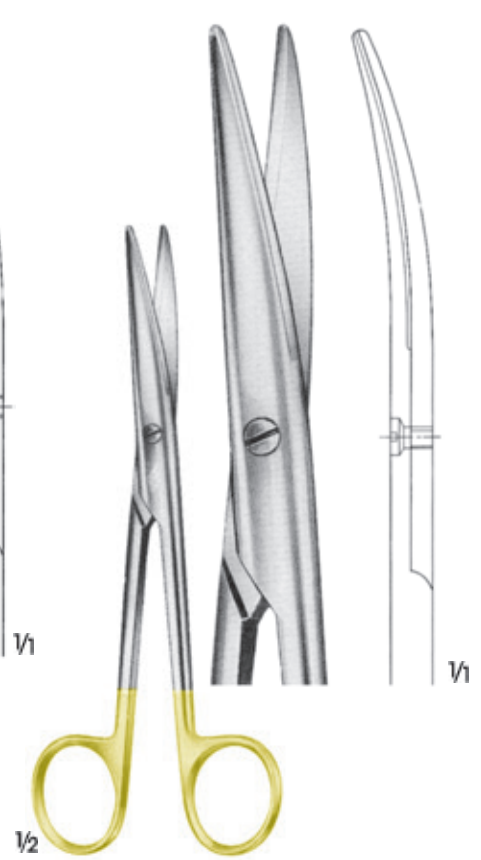


**MAYO**  
**42-254**  
Diseksiyon makası  
Dissecting scissors  
17 cm



**LEXER**  
**42-255**  
İnce diseksiyon makası  
Dissecting scissors, slender  
16.5 cm

V2

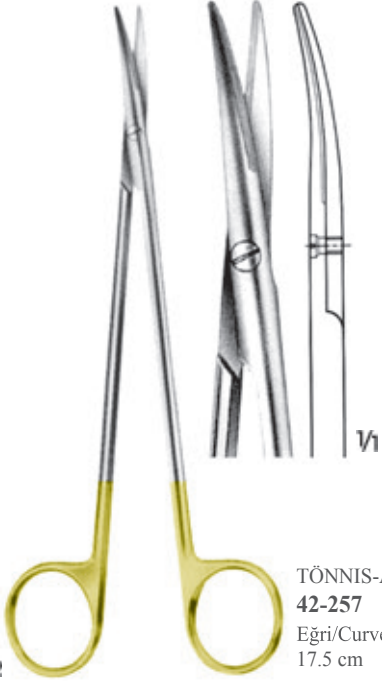


**MAYO-LEXER**  
**42-256**  
Diseksiyon makası  
Dissecting scissors  
16.5 cm

V2



*FineCut*



**TÖNNIS-ADSON**  
**42-257**  
 Eğri/Curved  
 17.5 cm

*FineCut*

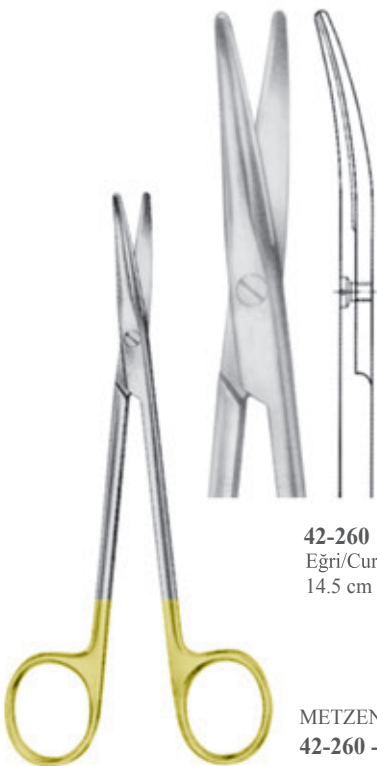


**BABY-METZENBAUM**  
**42-258**  
 Eğri/Curved  
 14.5 cm

*FineCut*

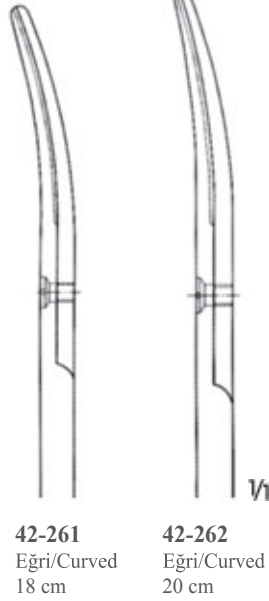


**42-259**  
 Eğri/Curved  
 11.5 cm



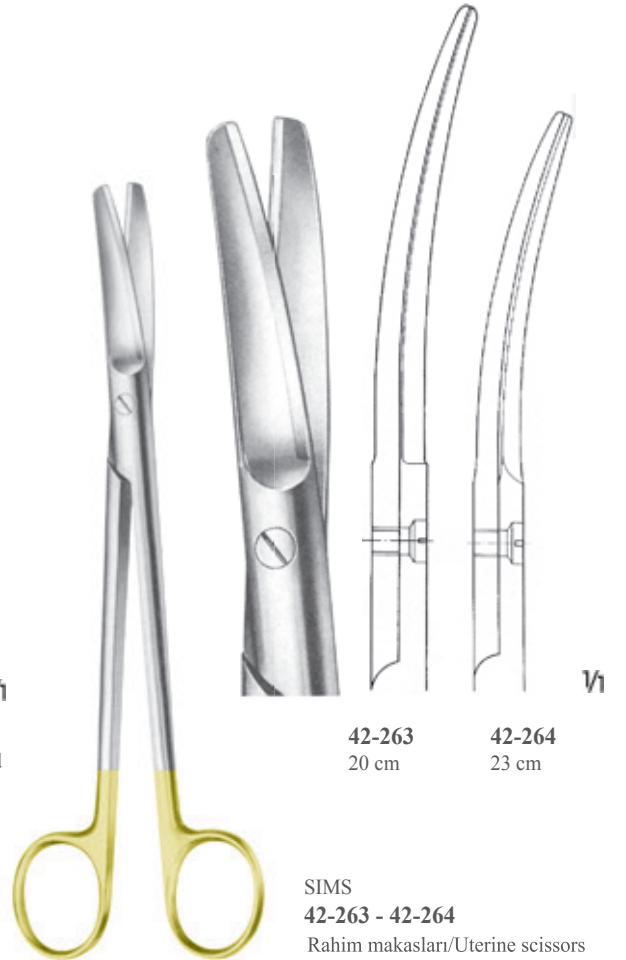
**42-260**  
 Eğri/Curved  
 14.5 cm

**METZENBAUM**  
**42-260 - 42-262**



**42-261**  
 Eğri/Curved  
 18 cm

**42-262**  
 Eğri/Curved  
 20 cm



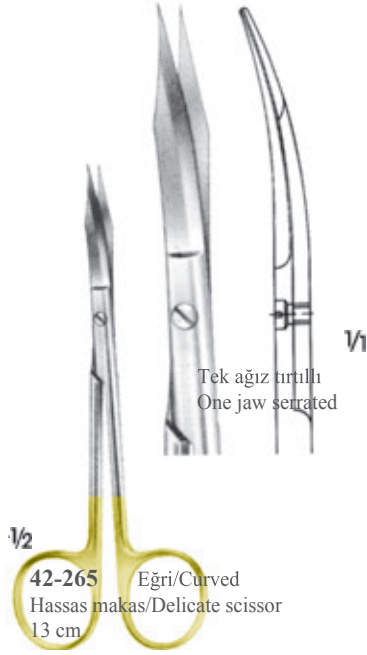
**SIMS**  
**42-263 - 42-264**  
 Rahim makasları/Uterine scissors

Karbür kesme ucu yerleştirilmiş **HARDTIPS** makaslar  
 - Mükemmel kesim  
 - Uzun çalışma ömrü

**HARDTIPS** scissors with inserted carbide cutting edges  
 - Excellent Cutting  
 - Long working

*FineCut*

*FineCut*



**42-266**

**42-267**

**42-266 - 42-267**  
 Cerrahi makaslar/Surgical scissors  
 Sivri/Sharp  
 Künt/Blunt  
 14.5 cm

*FineCut*



**42-268 - 42-269**  
 Hassas ligatür makasları  
 Delicate ligature scissors  
 11 cm



**42-270 - 42-271**  
 Hassas makaslar  
 Delicate scissors  
 12 cm

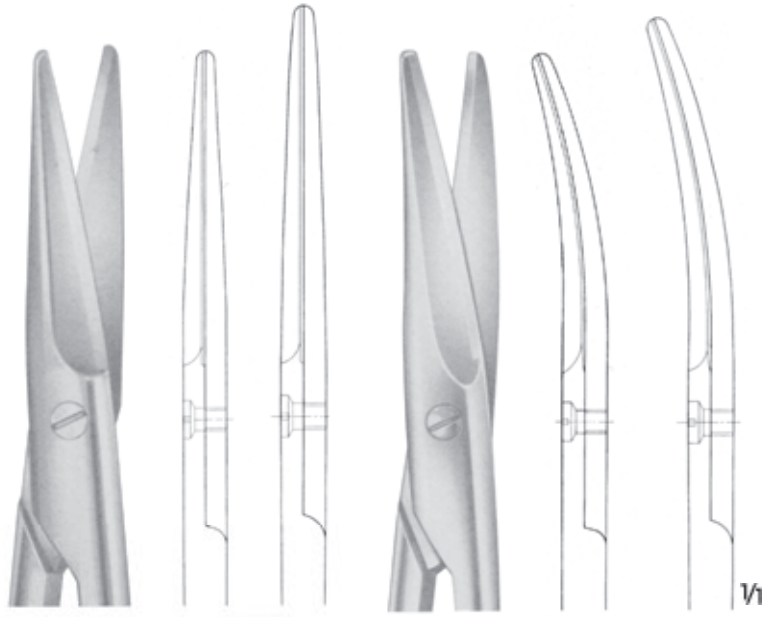






MAYO  
42-272 - 42-275

Diseksiyon makasları/Dissecting scissors

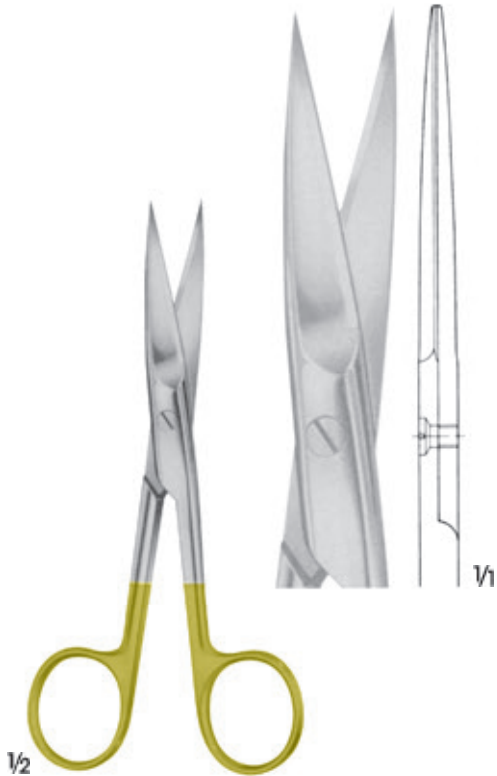


42-272  
Düz/Straight  
14 cm

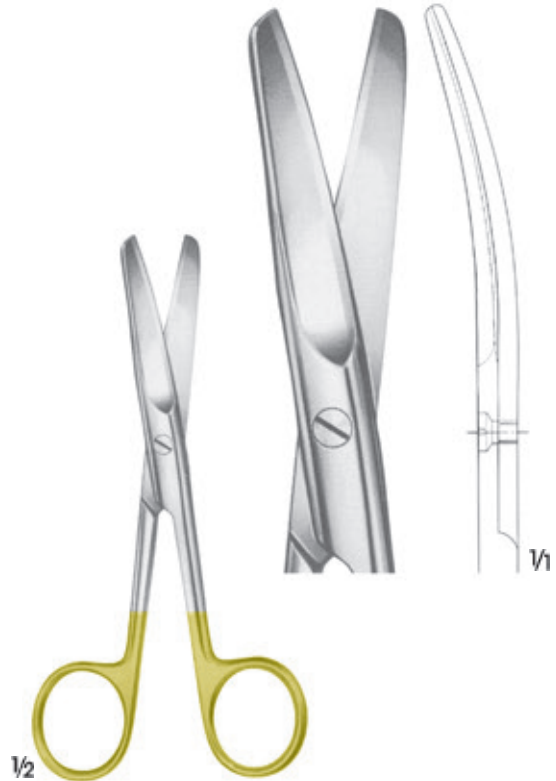
42-273  
Düz/Straight  
17 cm

42-274  
Eğri/Curved  
14 cm

42-275  
Eğri/Curved  
17 cm



42-276  
Cerrahi makas/Surgical scissors  
14.5 cm



42-277  
Cerrahi makas/Surgical scissors  
14.5 cm



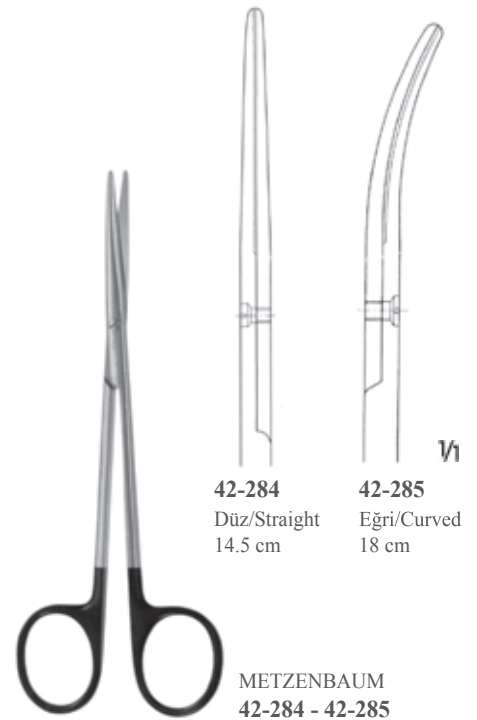
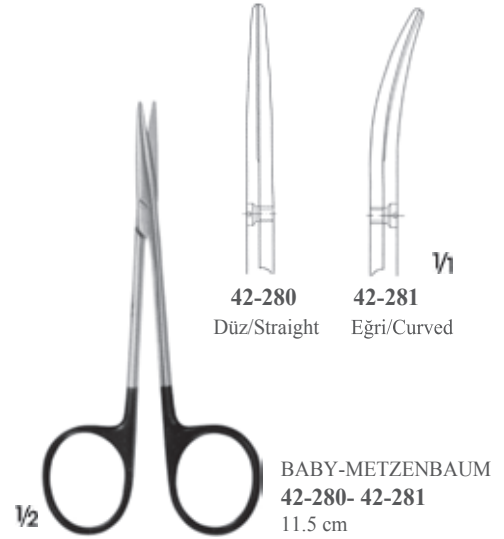


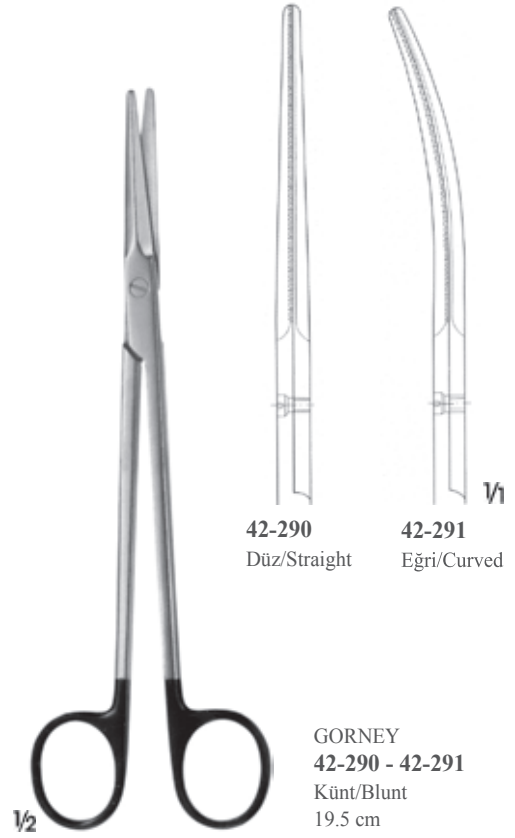
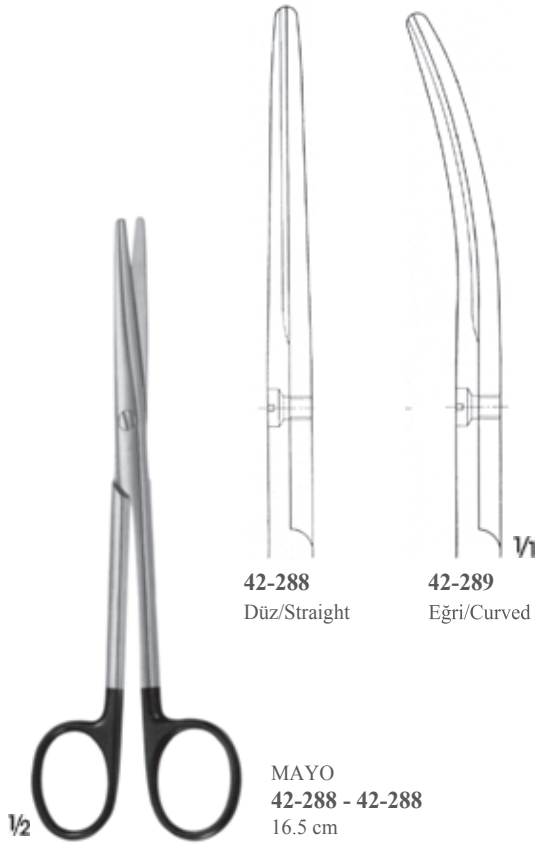
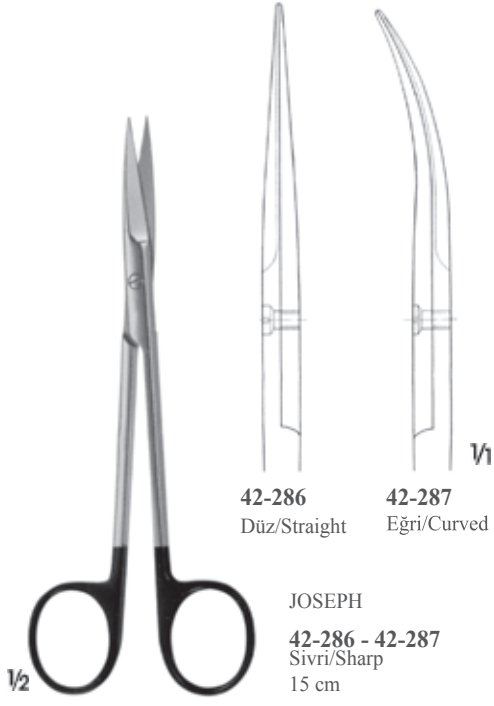
Dikiş malzemelerinin kesimi için ;

- *GripCut* makasın üzerindeki karbid uçları kalıcı keskinlik sağlar. (Makas ağzının uçları da dahil)
- *GripCut* makasın üzerindeki Tırtıklı ağız dikiş malzemelerinin dışarıya kaymasını engeller.

Cutting suture materials;

- Carbide inserts on *GripCut* scissors provide lasting sharpness. (including tip of the blades of the scissors)
- Serrated edges on *GripCut* scissors prevents suture materials from slipping out.







*GripCut* kesme sırasında dokunun kaymasını engeller.  
*GripCut* prevents tissue from slipping out during the cutting process



**42-292**  
Tek ağız tırtıllı/One jaws serrated  
11.5 cm



**42-293**  
Tek ağız tırtıllı/One jaws serrated  
14.5 cm



**42-294**  
16.5 cm

**42-295**  
16.5 cm

MAYO-LEXER  
**42-294 - 42-295**  
Tek ağız tırtıllı/One jaw



**42-296**  
14.5 cm

**42-297**  
18 cm

**42-298**  
20 cm

**42-299**  
18 cm

**42-300**  
20 cm

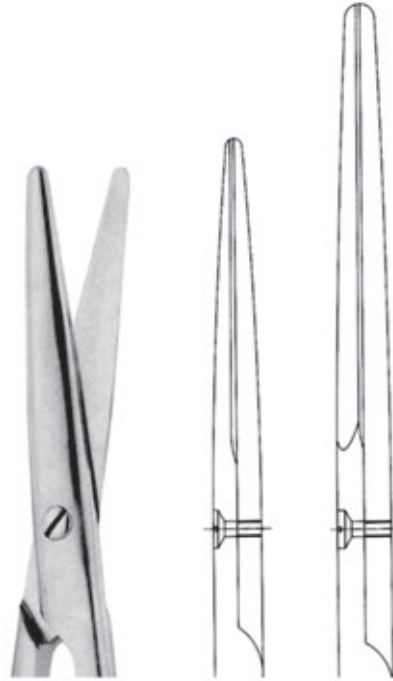
METZENBAUM  
**42-296 - 42-300**  
Tek ağız tırtıllı/One jaws serrated







MAYO  
42-310- 42-311

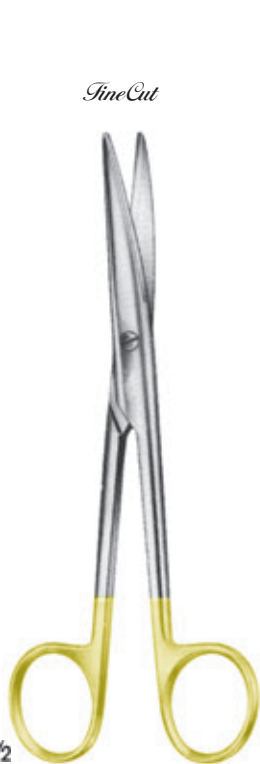
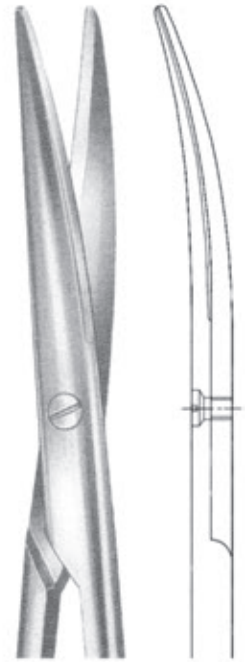


42-310  
17 cm

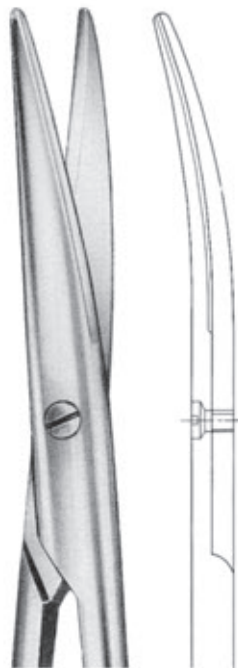
42-311  
23 cm



*FineCut*  
LEXER  
42-312  
Dar/Narrow  
16.5 cm



*FineCut*  
MAYO-LEXER  
42-313  
16.5 cm



42-314  
17 cm

42-315  
23 cm



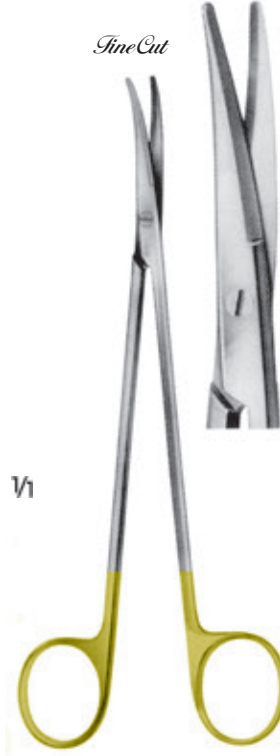
**METZENBAUM**  
**42-316 - 42-318**

**42-316**  
Düz/Straight  
18 cm

**42-317**  
Düz/Straight  
20 cm

**42-318**  
Düz/Straight  
23 cm

1/1



**METZENBAUM**  
**42-319 - 42-321**

**42-319**  
Eğri/Curved  
18 cm

**42-320**  
Eğri/Curved  
20 cm

**42-321**  
Eğri/Curved  
23 cm

1/1



1/2

**TÖNNIS-ADSON**  
**42-322** Eğri/Curved  
17.5 cm

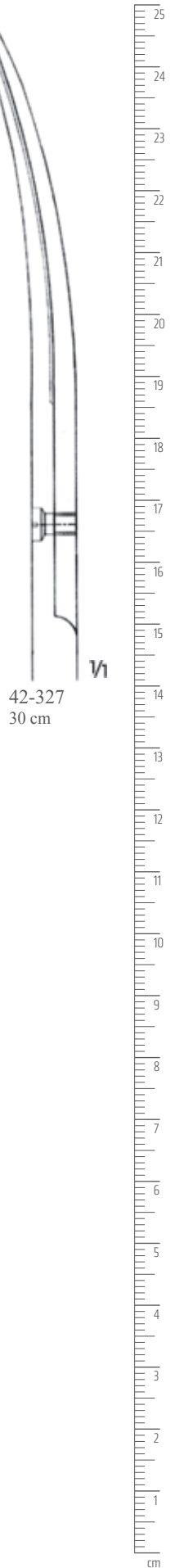
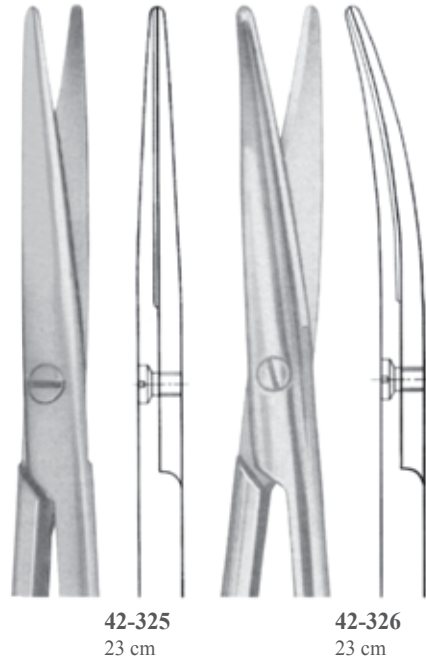
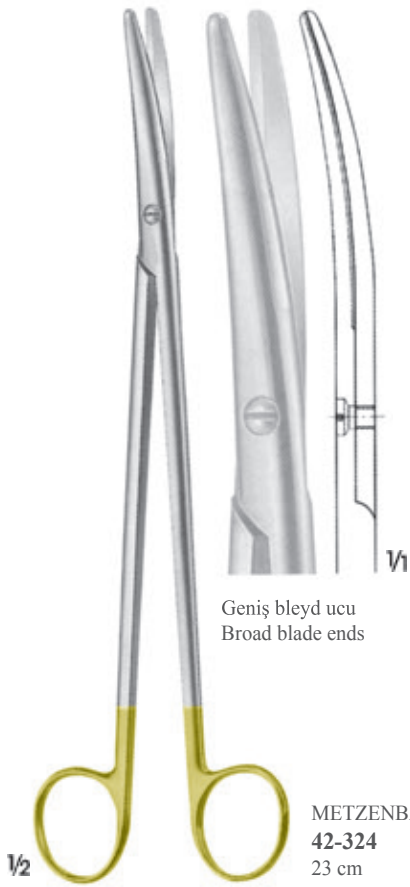
1/1



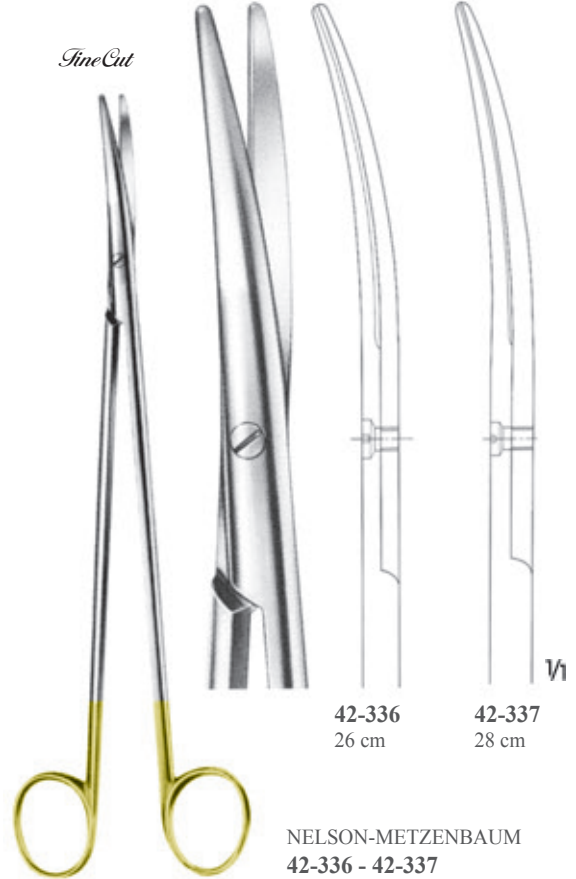
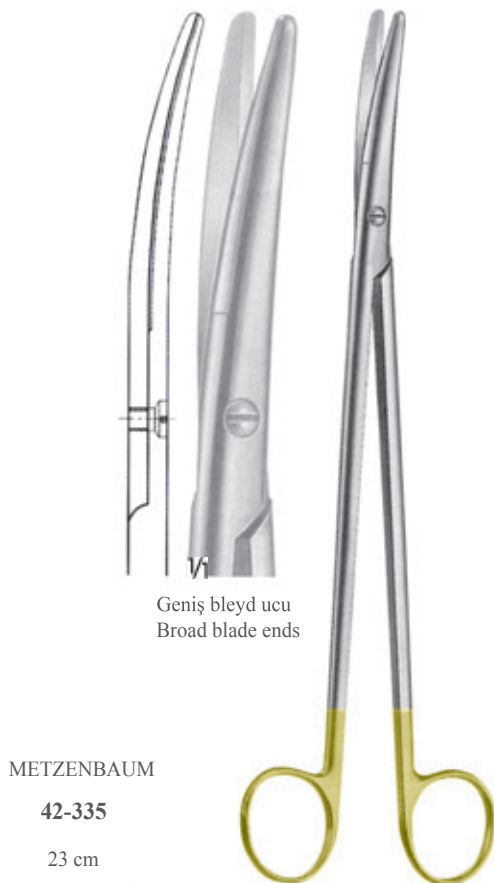
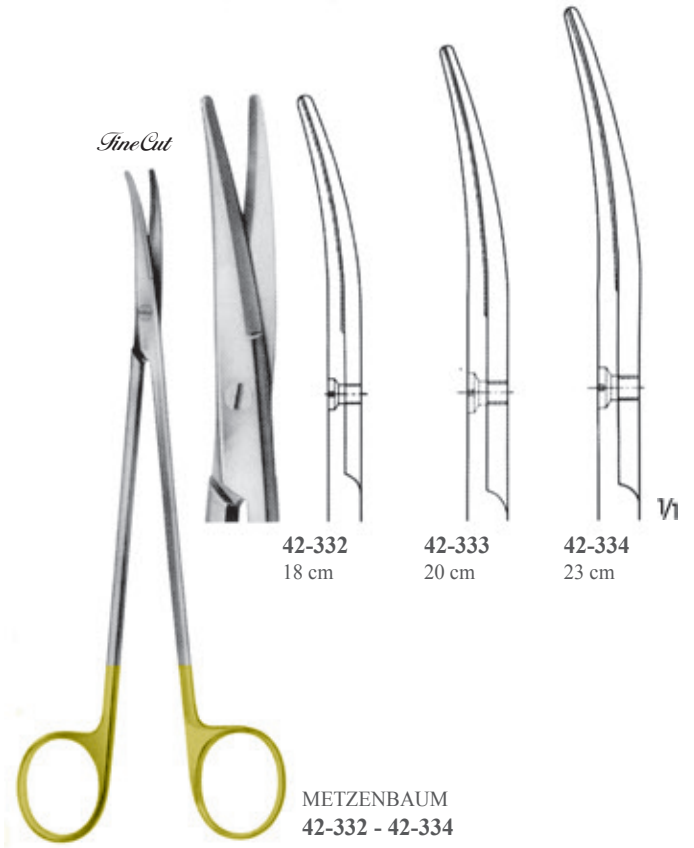
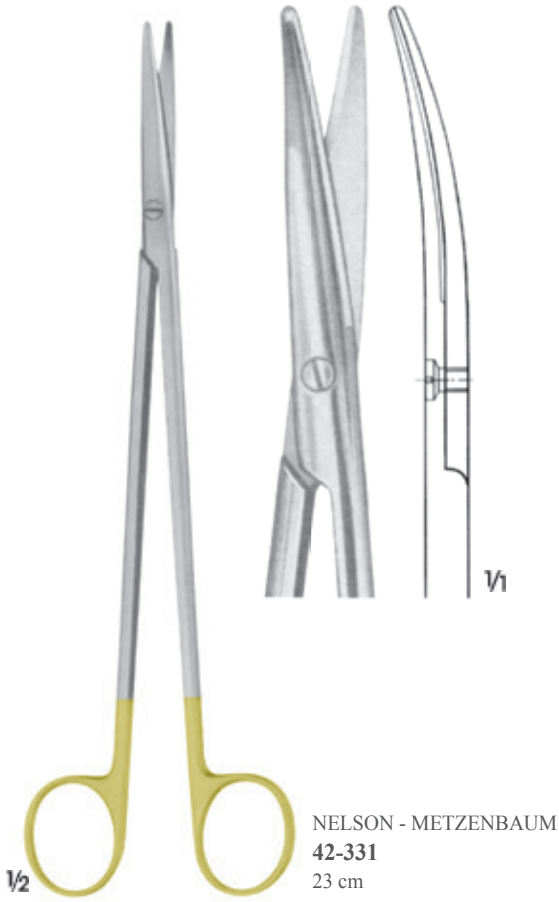
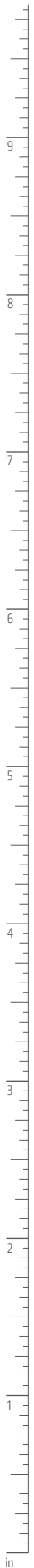
**METZENBAUM-NELSON**  
**42-323** Eğri/Curved  
35 cm

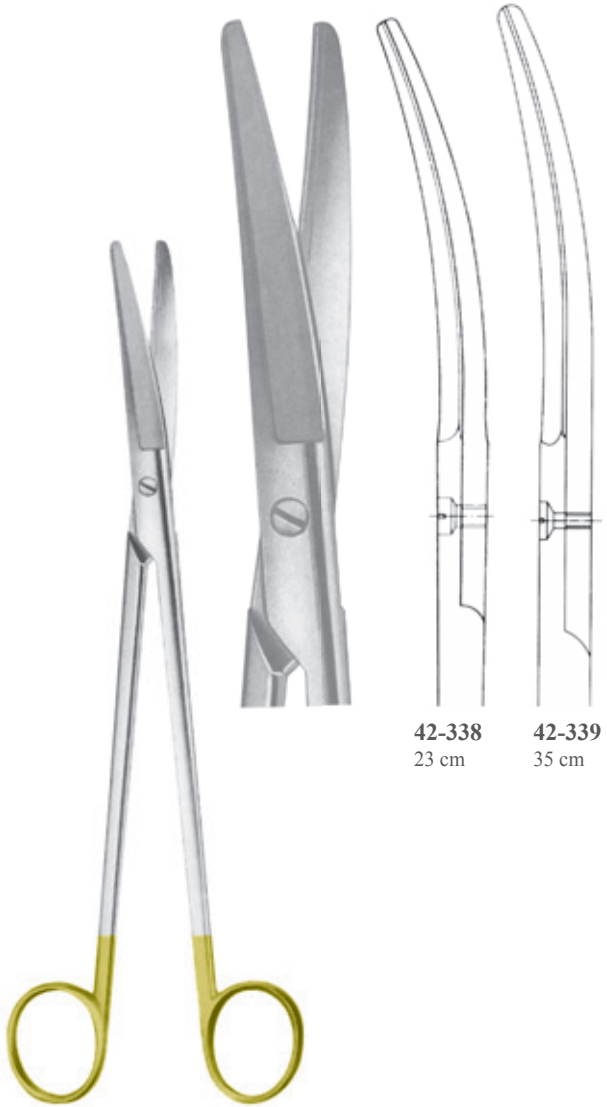
1/1







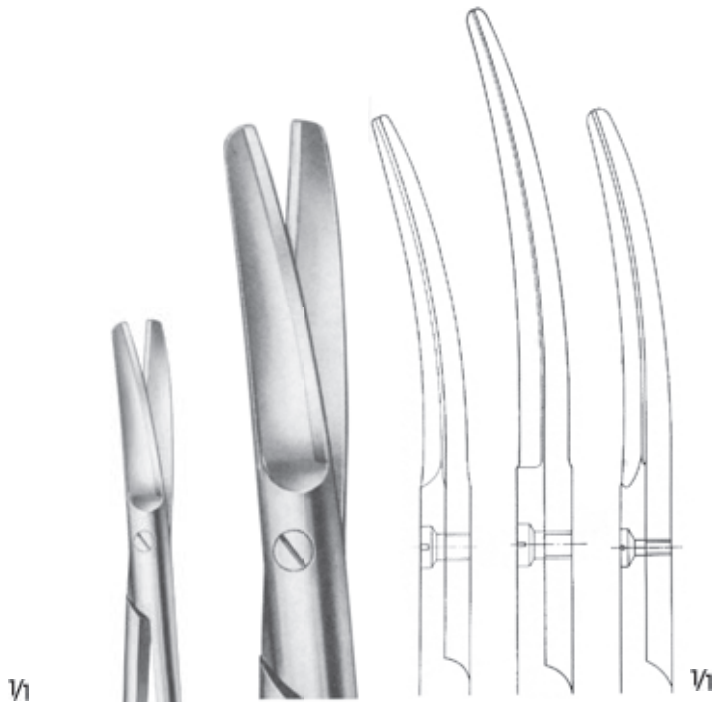




**42-338**  
23 cm

**42-339**  
35 cm

WERTHEIM  
**42-338 - 42-339**  
 Diseksiyon makasları/Dissecting scissors



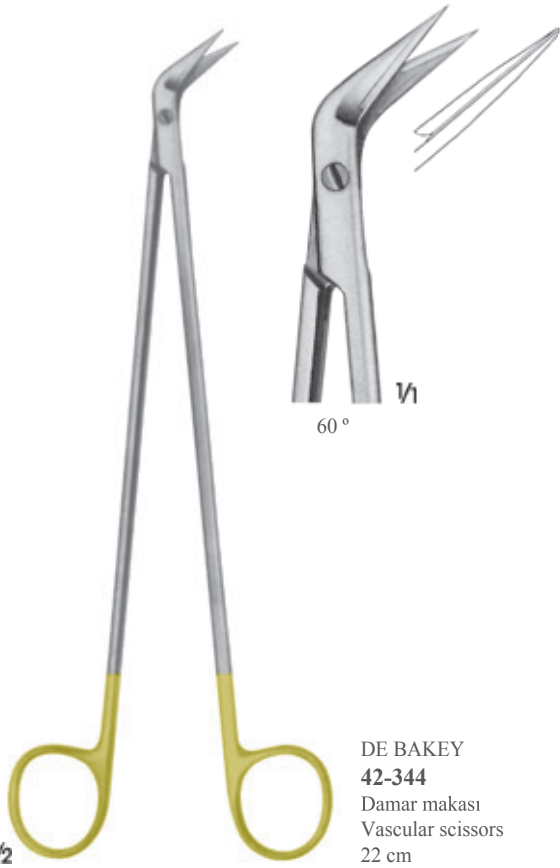
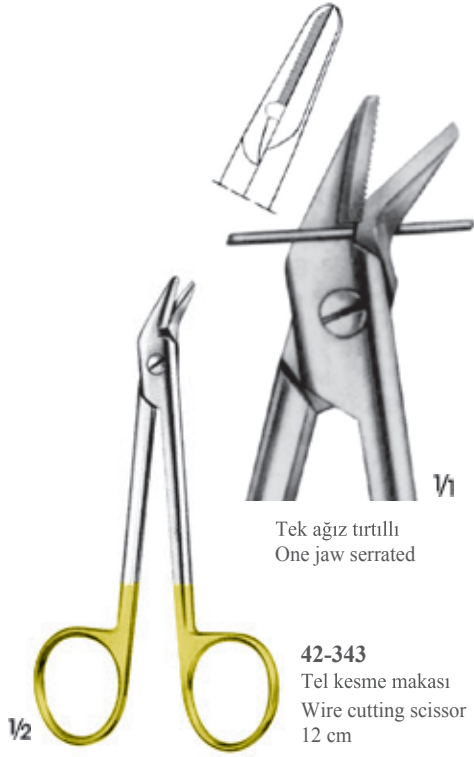
**42-340**  
20 cm

**42-341**  
23 cm

**42-342**  
35 cm

SIMS  
**42-340 - 42-342**  
 Rahim makasları/Uterine Scissors





Dikiş malzemelerinin kesimi için ;

- *GripCut* makasın üzerindeki karbid uçları kalıcı keskinlik sağlar. (Makas ağzının uçları da dahil)
- *GripCut* makasın üzerindeki Tırtıklı ağız dikiş malzemelerinin dışarıya kaymasını engeller.

Cutting suture materials;

- Carbide inserts on *GripCut* scissors provide lasting sharpness. (including tip of the blades of the scissors)
- Serrated edges on *GripCut* scissors prevents suture materials from slipping out.



42-347 / 42-351



**42-347**  
 Tek ağız tırtıllı  
 One jaw serrated  
 14.5 cm



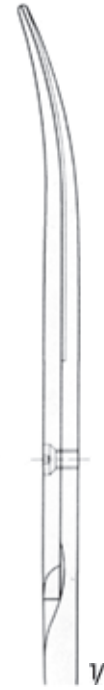
**42-348**  
 Tek ağız tırtıllı  
 One jaw serrated  
 18 cm



**42-349**  
 Tek ağız tırtıllı  
 One jaw serrated  
 23 cm



**42-350**  
 Tek ağız tırtıllı  
 One jaw serrated  
 26 cm



**42-351**  
 Tek ağız tırtıllı  
 One jaw serrated  
 35 cm





1/2  
42-352 - 42-353  
9.5 cm



42-352  
Düz/Straight



42-353  
Eğri/Curved



1/2  
42-354 - 42-355  
10.5 cm



42-354  
Düz/Straight



42-355  
Eğri/Curved



1/2  
42-356 - 42-357  
9 cm



42-356  
Düz/Straight



42-357  
Eğri/Curved



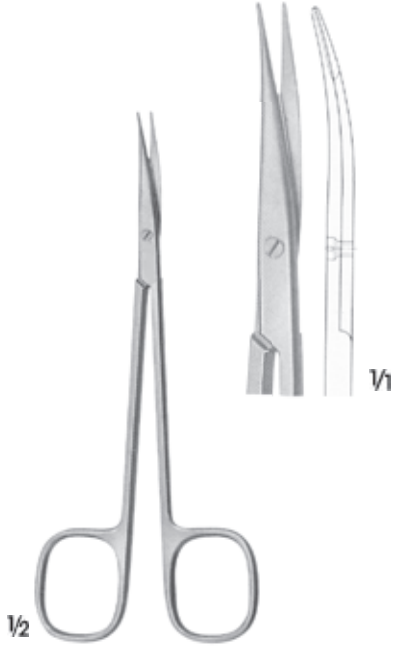
1/2  
42-358 - 42-359  
12 cm



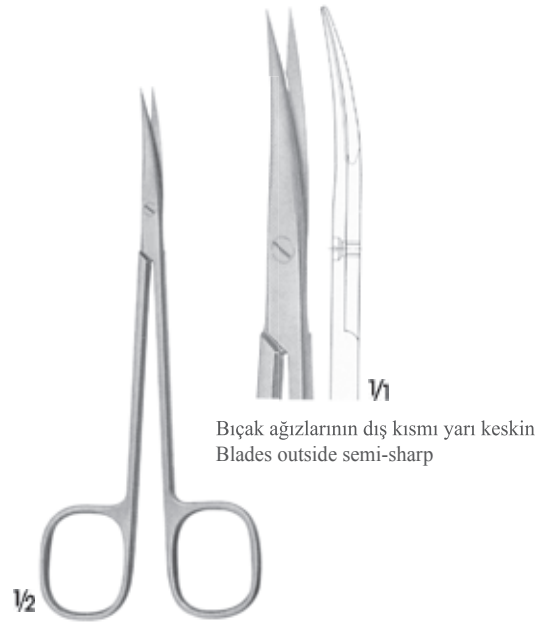
42-358  
Düz/Straight



42-359  
Eğri/Curved



REYNOLDS-JAMESON  
**42-360**  
Vasküler makas/Vascular scissors  
14 cm

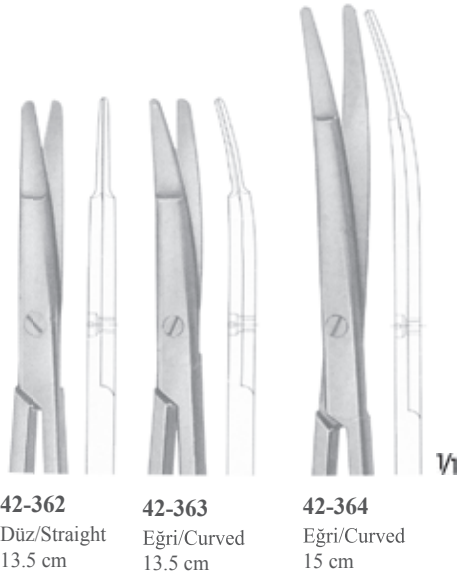


Bıçak ağzlarının dış kısmı yarı keskin  
Blades outside semi-sharp

**42-361**  
Diseksiyon, sinir makası  
Nerve dissecting scissors  
14 cm



RAGNELL  
**42-362 - 42-364**  
Diseksiyon ve cilt altı için özel düz uçlar  
Special flat points for dissecting and  
undermining the skin



**42-362**  
Düz/Straight  
13.5 cm

**42-363**  
Eğri/Curved  
13.5 cm

**42-364**  
Eğri/Curved  
15 cm



**42-365**  
Düz/Straight

**42-366**  
Eğri/Curved

METZENBAUM  
**42-365 - 42-366**  
Diseksiyon makasları/Dissecting scissors  
14.5 cm



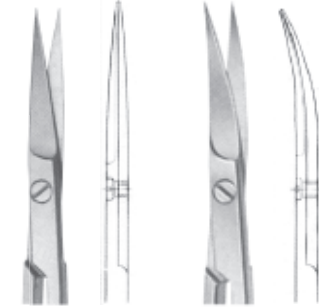


**42-367**  
Sivri/Sharp

**42-368**  
Sivri/Sharp

**42-369**  
Künt/Blunt

**42-370**  
Künt/Blunt



**42-371**  
Düz/Straight

**42-372**  
Eğri/Curved



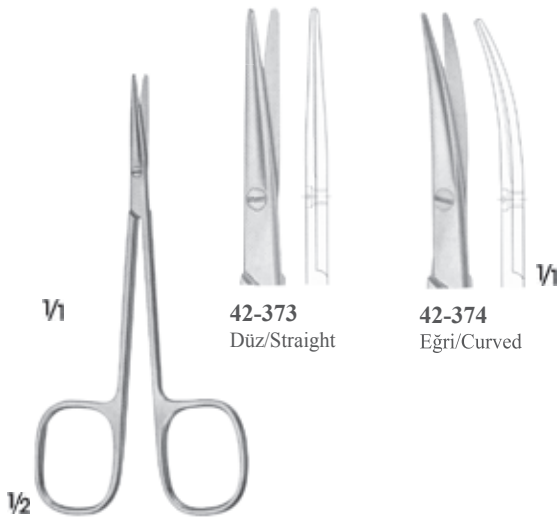
1/2

**STVENS**  
**42-367 - 42-370**  
Diseksiyon makasları/Dissecting scissors  
11.5 cm



1/2

**42-371 - 42-372**  
Hassas makaslar/Delicate scissors  
11.5 cm



1/1

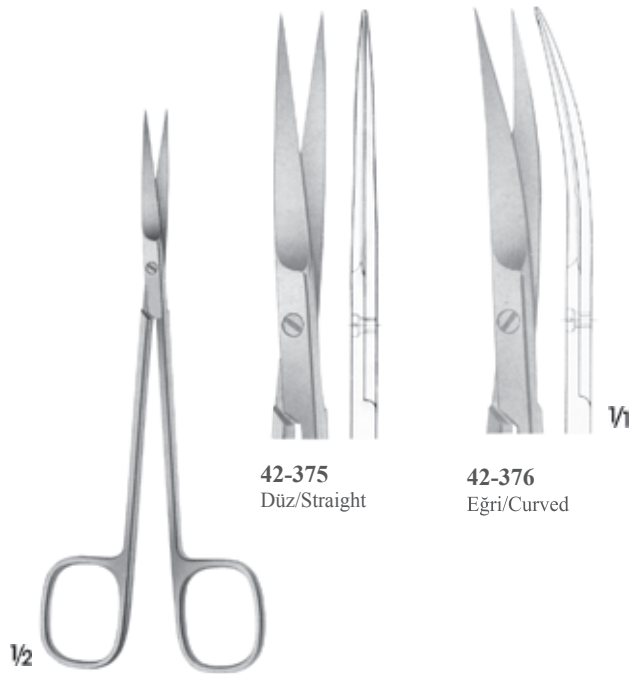
**42-373**  
Düz/Straight

**42-374**  
Eğri/Curved

1/1

1/2

**42-373 - 42-374**  
Diseksiyon ve şaşılık makasları  
Dissecting- and strabismus scissors  
11.5 cm



**42-375**  
Düz/Straight

**42-376**  
Eğri/Curved

1/1

1/2

**JOSEP**  
**42-375- 42-376**  
Hassas makaslar/Delicate scissors  
15 cm





42-377  
Düz/Straight

42-378  
Eğri/Curved

1/2

42-377 - 42-378  
12 cm



42-379  
Düz/Straight

42-380  
Eğri/Curved

1/2

42-379 - 42-380  
11.5 cm

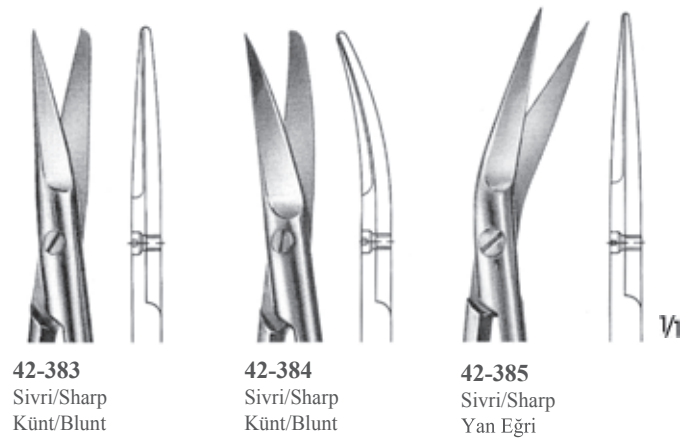


42-381  
Sivri/Sharp

42-382  
Sivri/Sharp

1/2

42-381 - 42-385  
11 cm



42-383  
Sivri/Sharp  
Künt/Blunt

42-384  
Sivri/Sharp  
Künt/Blunt

42-385  
Sivri/Sharp  
Yan Eğri  
Curved to side



**KILNER**  
**42-386**  
Hassas diseksiyon makası  
Delicate dissecting scissors  
11.5 cm



**42-387** Düz/Straight  
**42-388** Eğri/Curved  
Diseksiyon makasları  
Dissecting scissors  
11.5 cm



**GRAEFE**  
**42-389** Künt/Blunt  
Diseksiyon makası/Dissecting scissors  
10 cm

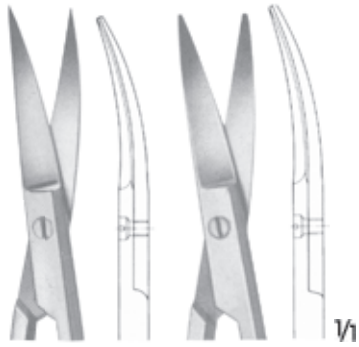


**COTTLE**  
**42-390**  
Bulldog makası/Bulldog scissors  
11.5 cm



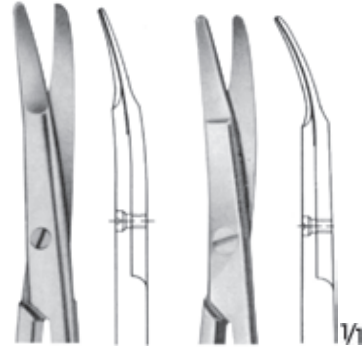
**LITTLER**  
**42-391**  
Diseksiyon makası ip kesici, delikli  
Dissecting scissors, tips with eye suture  
11.5 cm





**42-392**  
Sivri/Sharp

**42-393**  
Künt/Blunt



**42-394**  
Eğri/Curved  
12.5 cm

**42-395**  
Eğri/Curved  
15 cm



**COTTLE-MASING**  
**42-392 - 42-393**  
Plastik cerrahi makasları  
Scissors for plastic surgery  
10.5 cm



**KILNER**  
**42-394 - 42-395**  
Diseksiyon ve cilt altı için özel düz uçlar  
Special flat points for dissecting and  
undermining the skin



**LANDOLT**  
**42-396**  
Enuklasyon makası  
Enucleation scissors  
12 cm



**42-397**  
Eğri/Curved  
11.5 cm

**42-398**  
Eğri/Curved  
13.5 cm



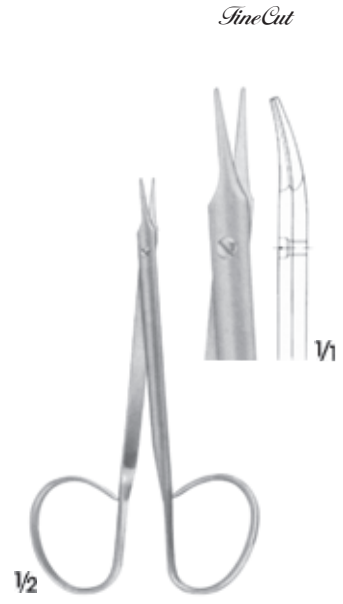
**FOMON**  
**42-397 - 42-398**  
Alt yanıl makaslar  
Lower lateral scissors



**42-399**  
Düz/Straight

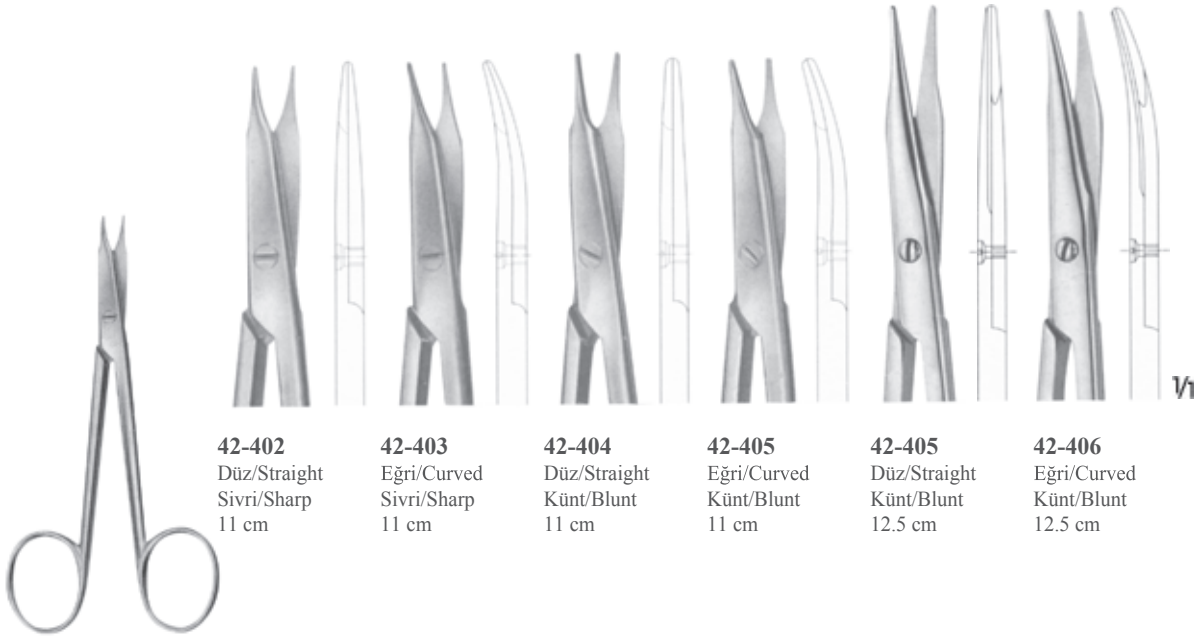


**42-400**  
Eğri/Curved



**42-401**  
Hassas diseksiyon makası

11 cm



**42-402**  
Düz/Straight  
Sivri/Sharp  
11 cm

**42-403**  
Eğri/Curved  
Sivri/Sharp  
11 cm

**42-404**  
Düz/Straight  
Künt/Blunt  
11 cm

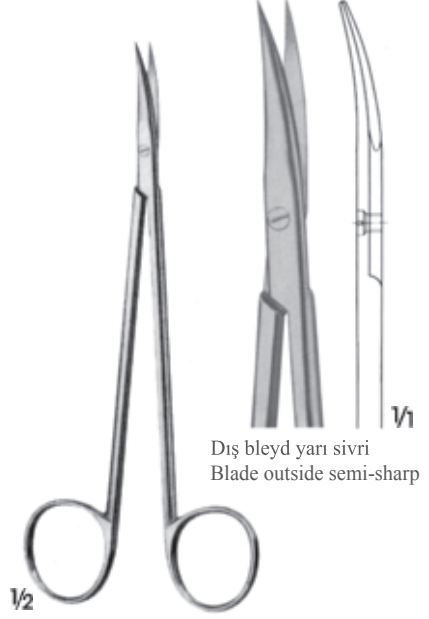
**42-405**  
Eğri/Curved  
Künt/Blunt  
11 cm

**42-405**  
Düz/Straight  
Künt/Blunt  
12.5 cm

**42-406**  
Eğri/Curved  
Künt/Blunt  
12.5 cm

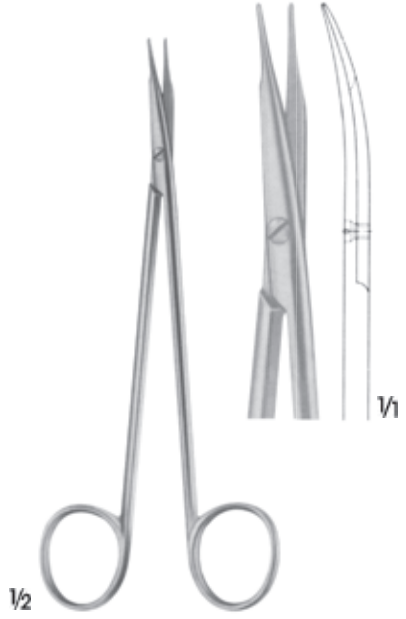
STEVENS  
**42-402 - 42-406**  
Damar ve tendon makasları  
Vascular and tendon scissors

Delicate dissecting scissors

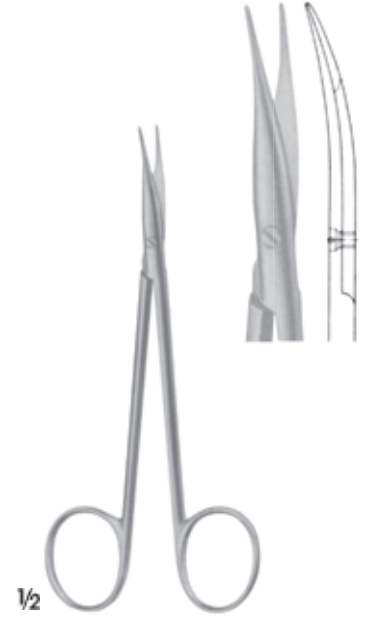


Dış bleyd yarı sivri  
Blade outside semi-sharp

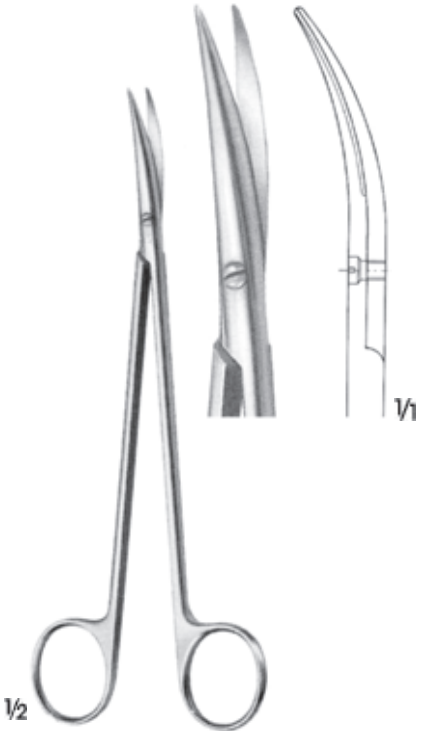
**42-407**  
Sinir, diseksiyon makası  
Nerve dissecting scissors  
15 cm



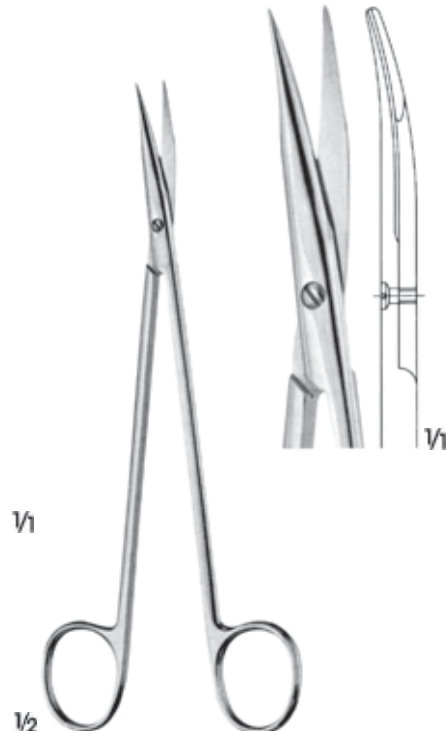
**JAMESON 42-408**  
Diseksiyon makası  
Dissecting scissors  
15 cm



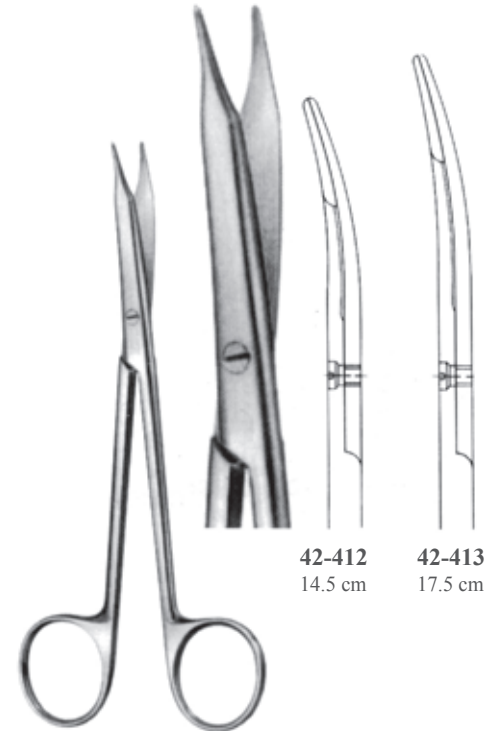
**JAMESON-WERBER 42-409**  
Diseksiyon makası  
Dissecting scissors  
13 cm



**DE BAKEY 42-410**  
Arteriyotomi makası  
Arteriotomy scissors  
17.5 cm



**POTTS 42-411**  
Diseksiyon makası  
Dissecting scissors  
18 cm



**REYNOLDS 42-412- 42-413**  
Diseksiyon makasları  
Dissecting scissors

**42-412**  
14.5 cm

**42-413**  
17.5 cm



Bleyd : Dış taraflar yarı keski  
İç taraflar ince tırtıllı  
Blade : Outside semi-sharp  
Inside fine serrated

GORNEY  
42-414

Diseksiyon makası plastik cerrahi için  
Dissection scissor for plastic surgery  
12.5 cm



1/2



42-415  
Çok hassas  
Very delicate

42-416  
Hassas  
Delicate

42-417  
Hassas  
Delicate

TÖNNIS  
42-415 - 42-417  
Diseksiyon makasları  
Dissecting scissors  
18 cm

1/2



42-418  
Düz/Straight

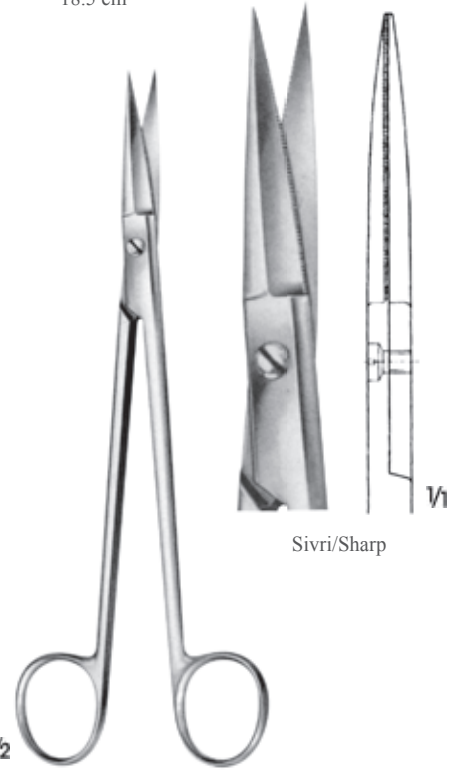
42-419  
Eğri/Curved

GORNEY  
42-418 - 42-419  
Diseksiyon makaları plastik cerrahi için  
Dissection scissors for plastic surgery  
19.5 cm

Bleydler : Dış taraflar yarı keski  
İç taraflar ince tırtıllı  
Blades : Outside semi-sharp  
Inside fine serrated



1/2



42-420  
Kıkırdak makası, çift ağız tırtıllı  
Cartilage scissors, blades  
cutting on both sides

Sivri/Sharp

1/2





Düz sap  
Flat handle



42-421 - 42-440  
16.5 cm

25°4

5°

Ultra hassas bleyd  
Ultra delicate blade

60°

90°

125°



42-421  
42-441

42-422  
42-442

42-423  
42-443

42-424  
42-444

42-425  
42-445

Hassas bleyd  
Delicate blade



(Düz Sap) - 42-426  
(Yuvarlak Sap) - 42-446

42-427  
42-447

42-428  
42-448

42-429  
42-449

42-430  
42-450

Ince bleyd,  
tek tarafı küre uçlu bleyd  
Fine blade,  
with 1 probe pointed blade

Yuvarlak sap  
Round handle



42-441 - 42-460  
16.5 cm



42-431  
42-451

42-432  
42-452

42-433  
42-453

42-434  
42-454

42-435  
42-455

Ince bleyd  
Fine blade



42-436  
42-456

42-437  
42-457

42-438  
42-458

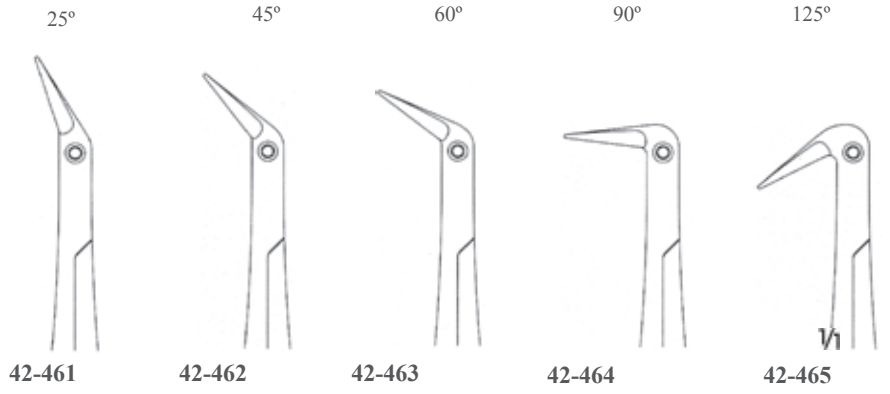
42-439  
42-459

42-440  
42-460

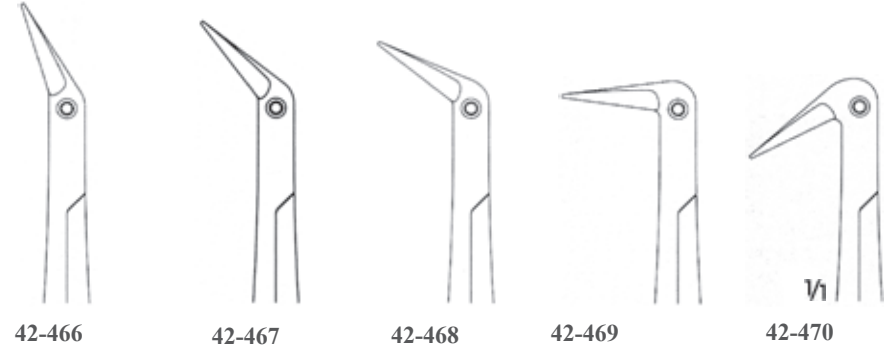




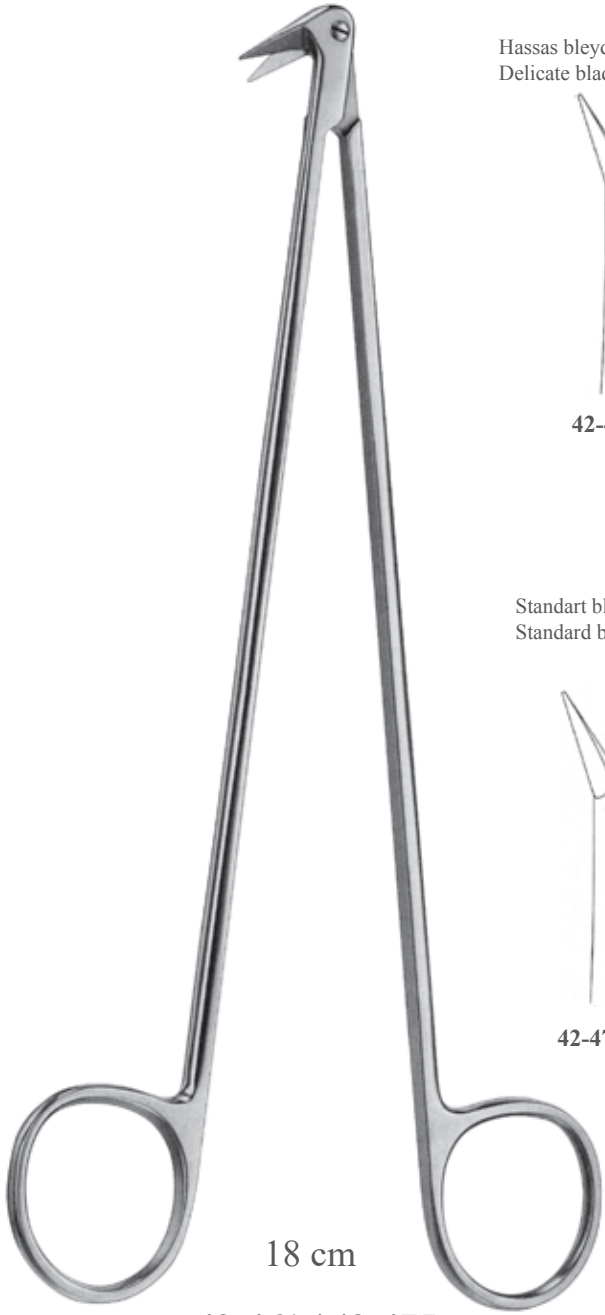
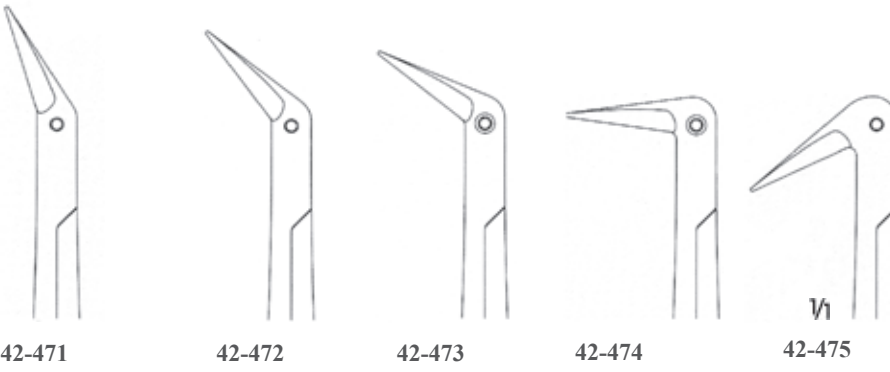
Ultra hassas bleyd  
Ultra delicate blade



Hassas bleyd  
Delicate blade



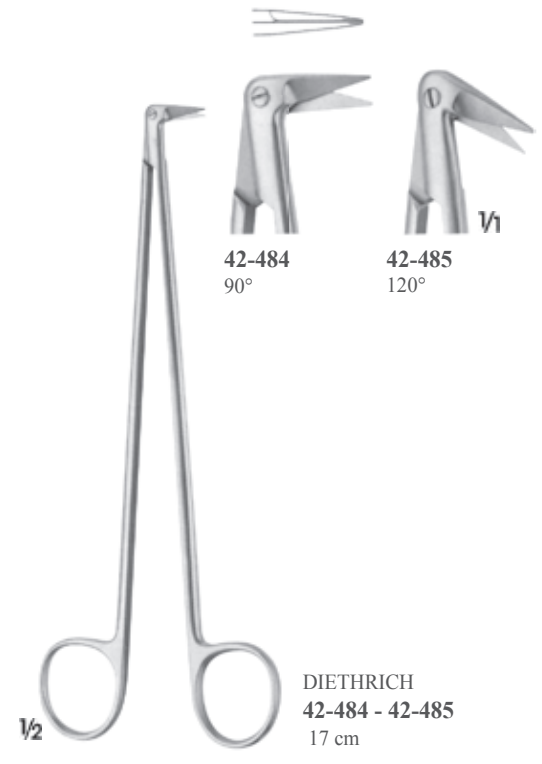
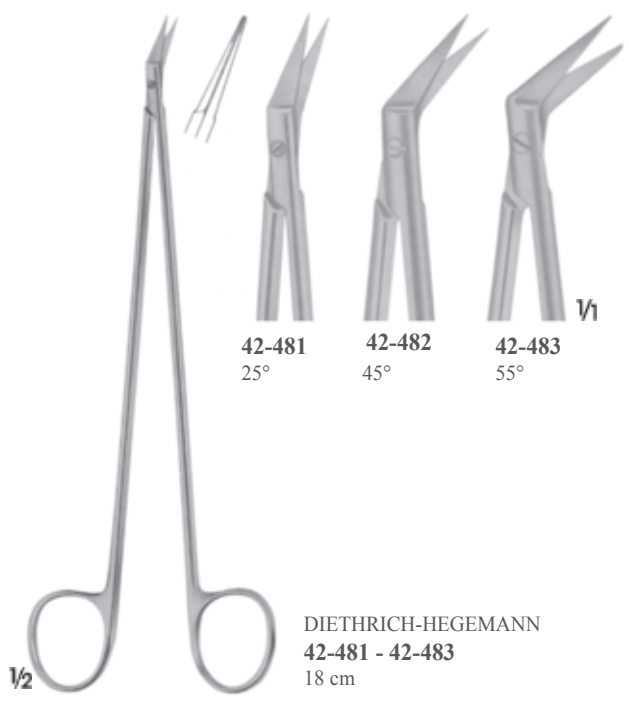
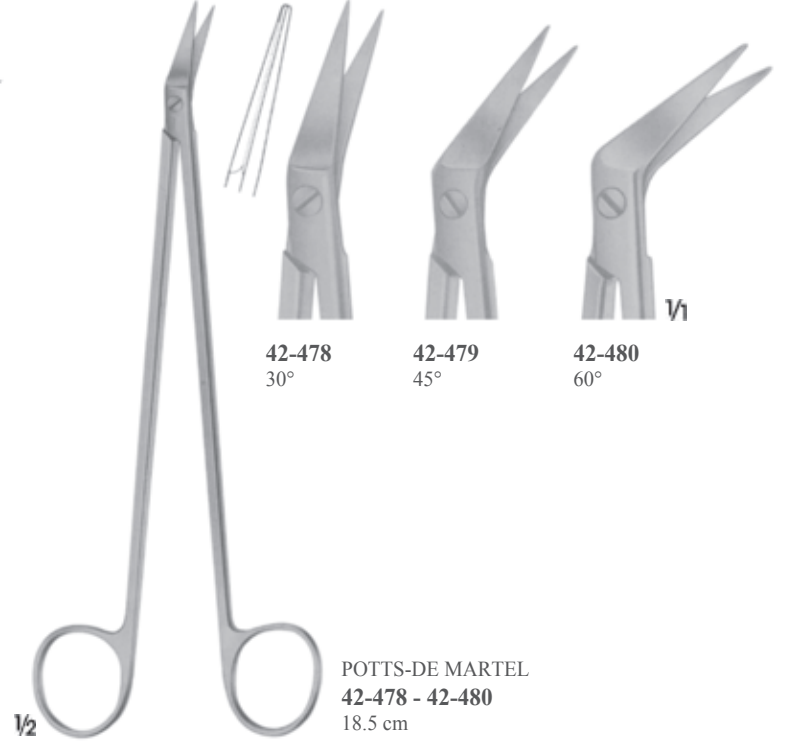
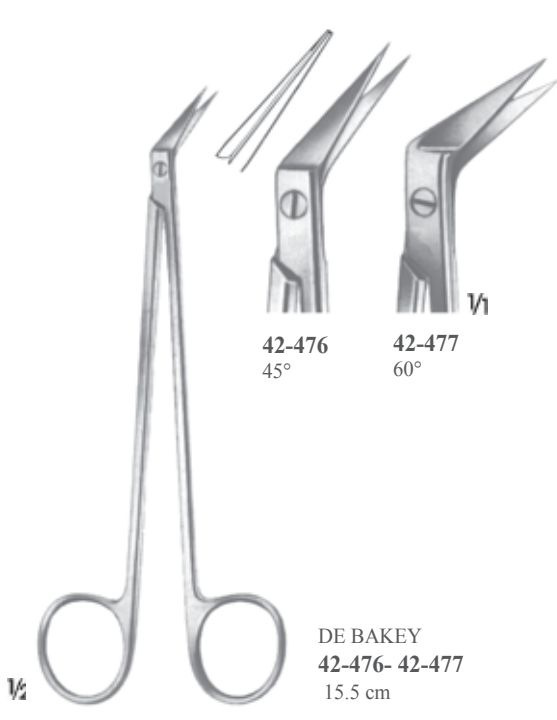
Standart bleyd  
Standard blade

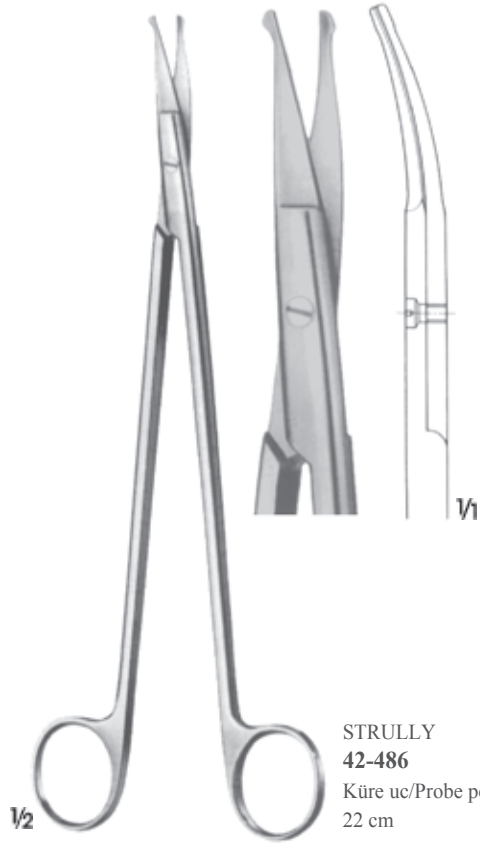


18 cm

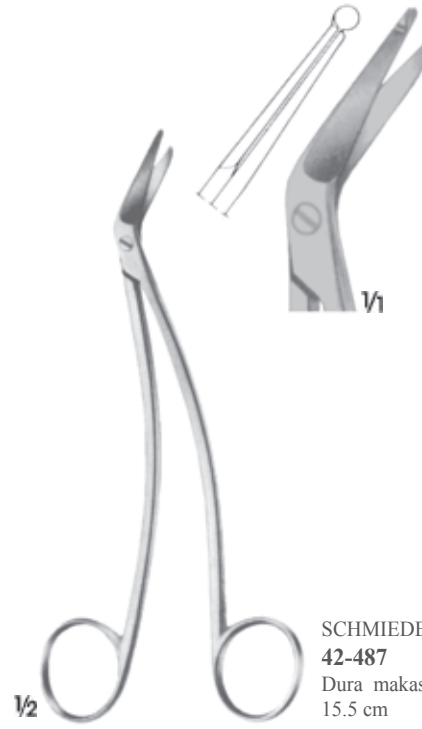
42-461 / 42-475

V1

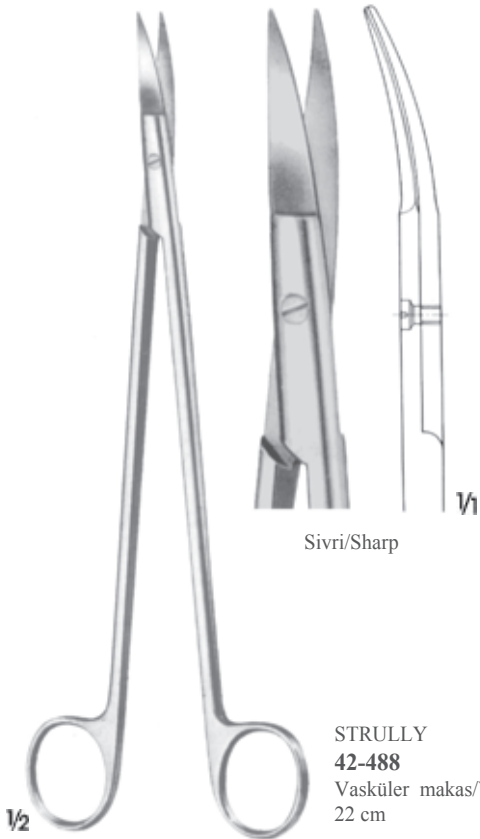




**STRULLY**  
**42-486**  
Küre uc/Probe pointed  
22 cm

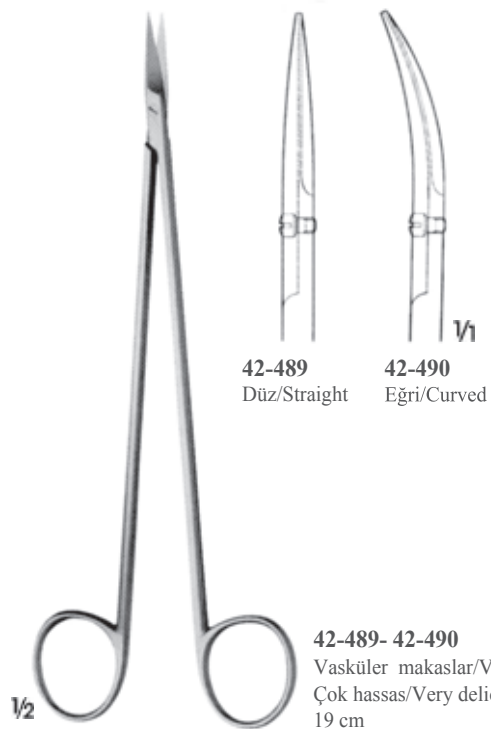


**SCHMIEDEN-TAYLOR**  
**42-487**  
Dura makas/Dura scissors  
15.5 cm



Sivri/Sharp

**STRULLY**  
**42-488**  
Vasküler makas/Vascular scissors  
22 cm

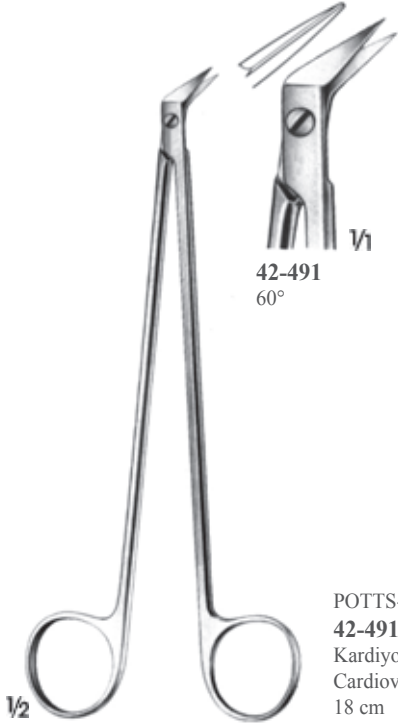


**42-489**  
Düz/Straight

**42-490**  
Eğri/Curved

**42-489- 42-490**  
Vasküler makaslar/Vascular scissors  
Çok hassas/Very delicate  
19 cm





42-491  
60°

POTTS-SMITH  
42-491  
Kardiyovasküler makas  
Cardiovascular scissors  
18 cm



POTTS-  
DE MARTEL  
42-492 60°

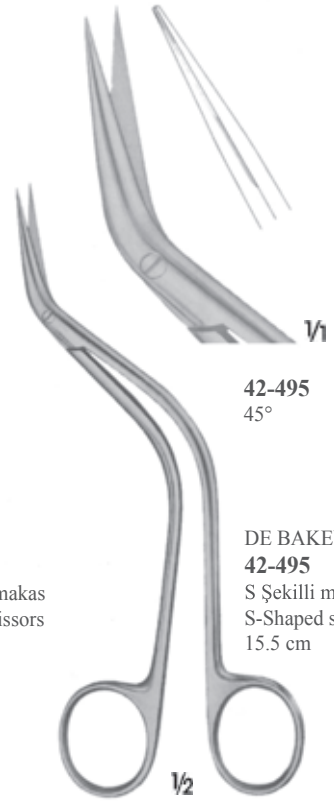
MILLS  
42-493 60°

42-492 - 42-493  
Kardiyovasküler makaslar  
Cardiovascular scissors  
22 cm



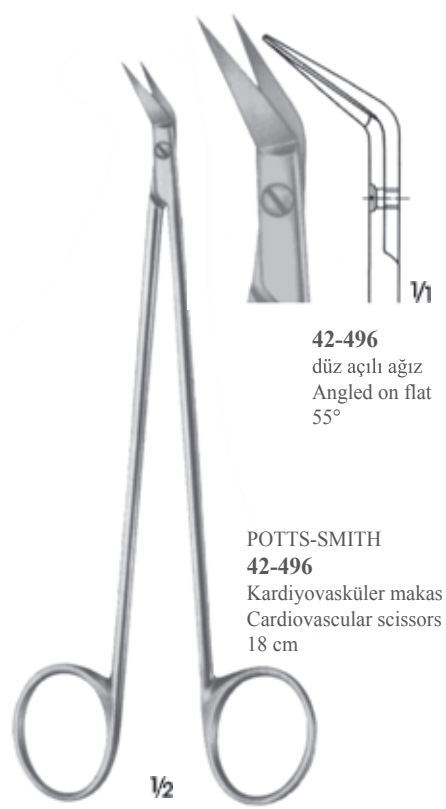
42-494  
55°

FAVOLORO  
42-494  
Kardiyovasküler makas  
Cardiovascular scissors  
14 cm



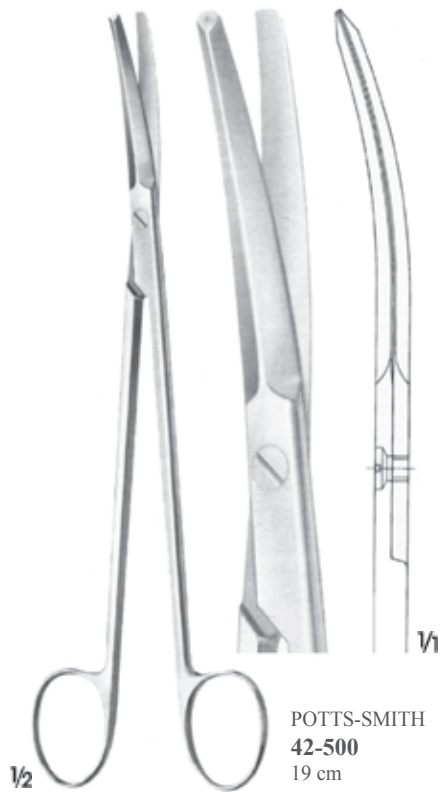
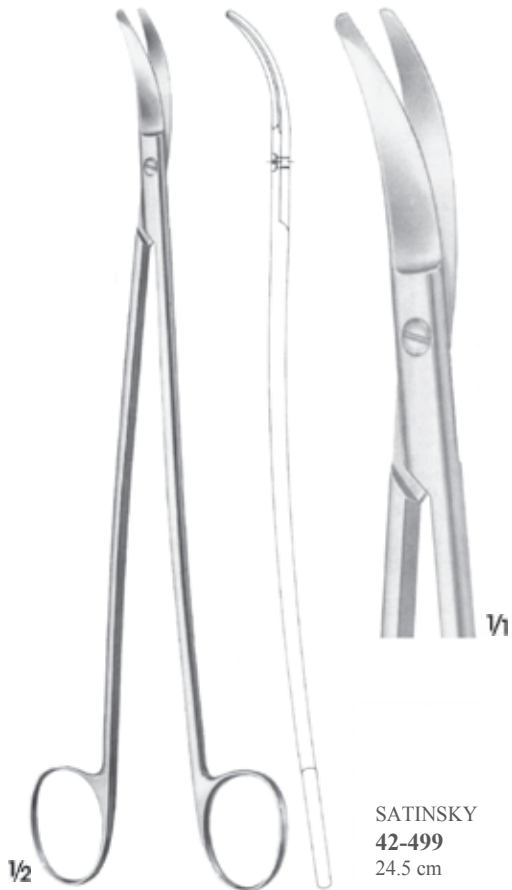
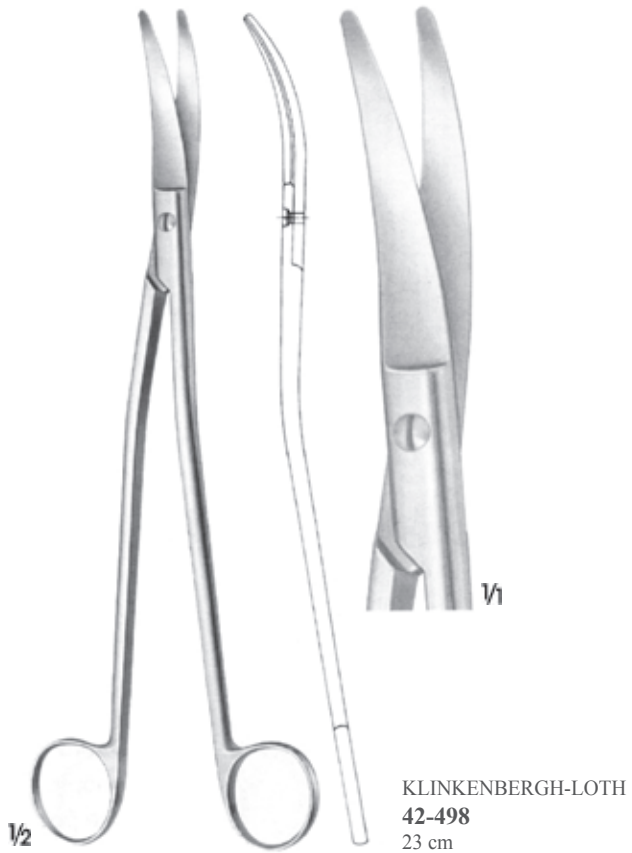
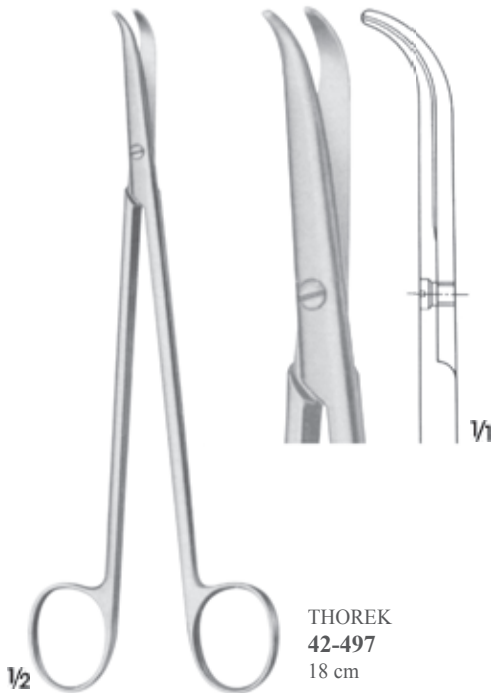
42-495  
45°

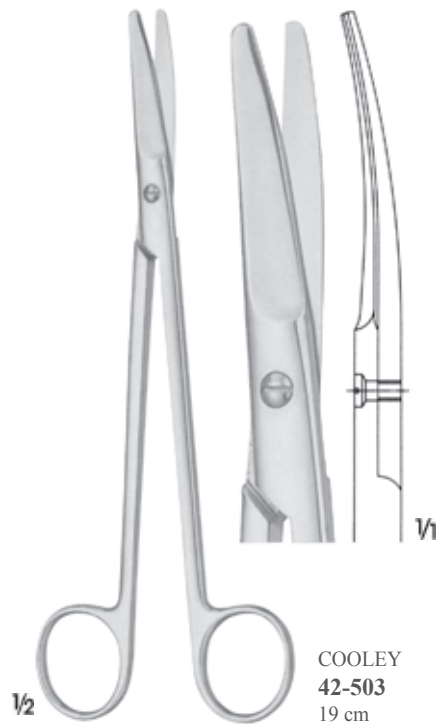
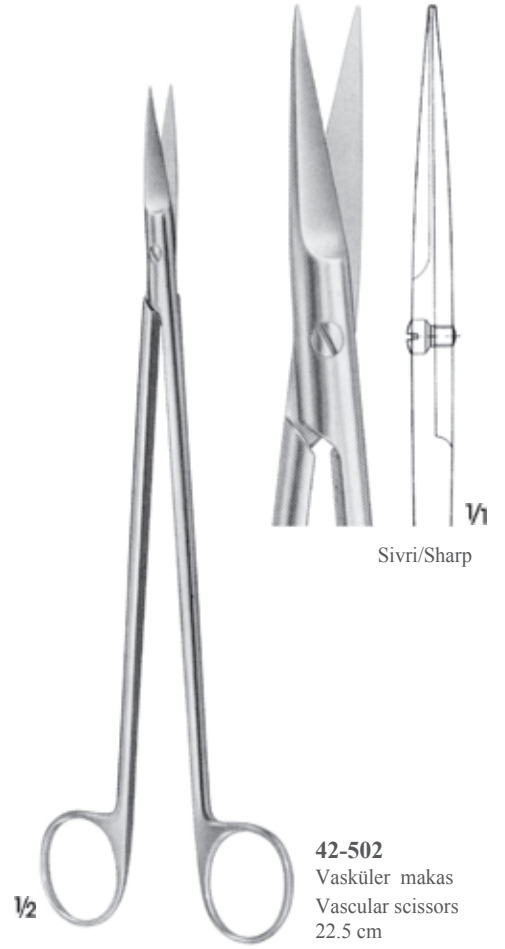
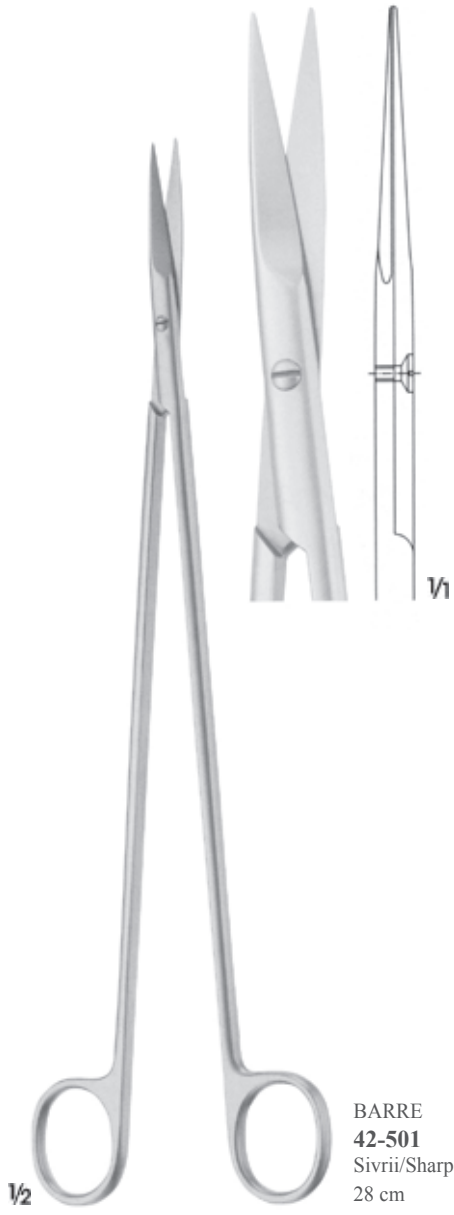
DE BAKEY  
42-495  
S Şekli makas  
S-Shaped scissor  
15.5 cm



42-496  
düz açılı ağız  
Angled on flat  
55°

POTTS-SMITH  
42-496  
Kardiyovasküler makas  
Cardiovascular scissors  
18 cm







**42-504**  
19 cm



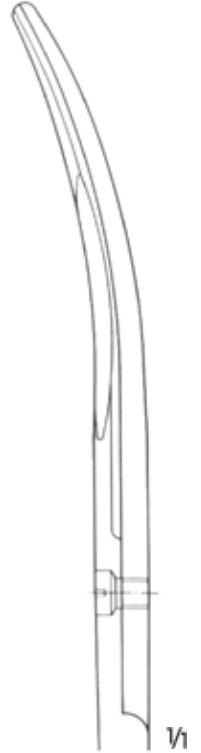
**42-505**  
21.5 cm



**42-506**  
19 cm



**42-507**  
21.5 cm



MAYO  
**42-504 - 42-507**  
Uc kısmı oyuk yapraklı  
With chamfered blades



**42-508**  
14 cm



**42-509**  
17 cm



**42-510**  
14 cm

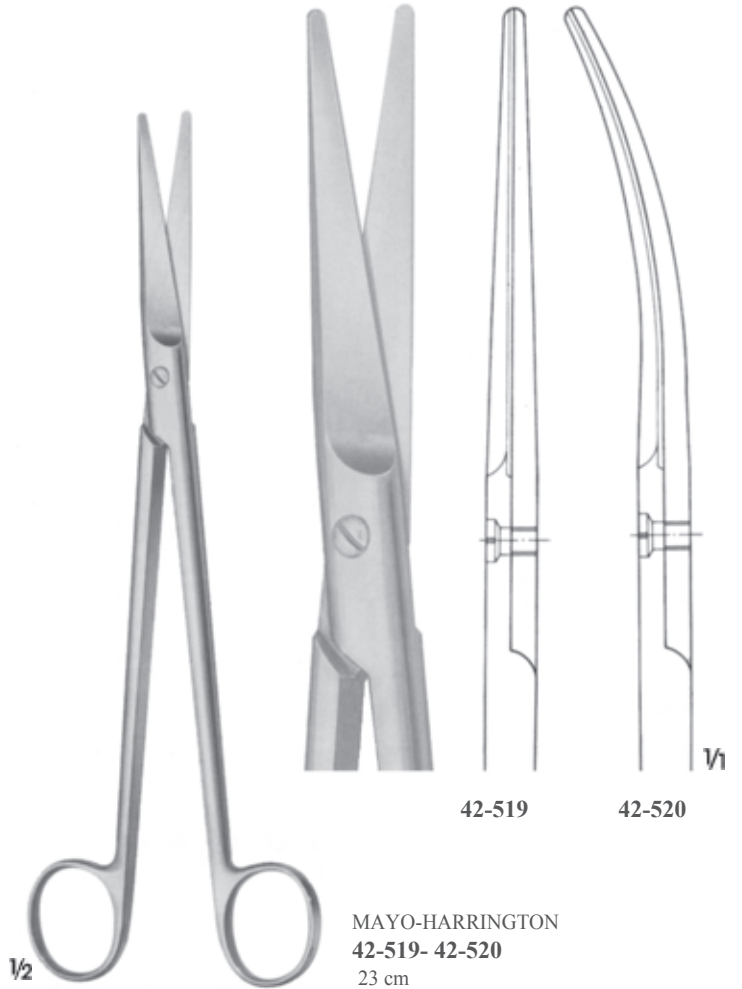
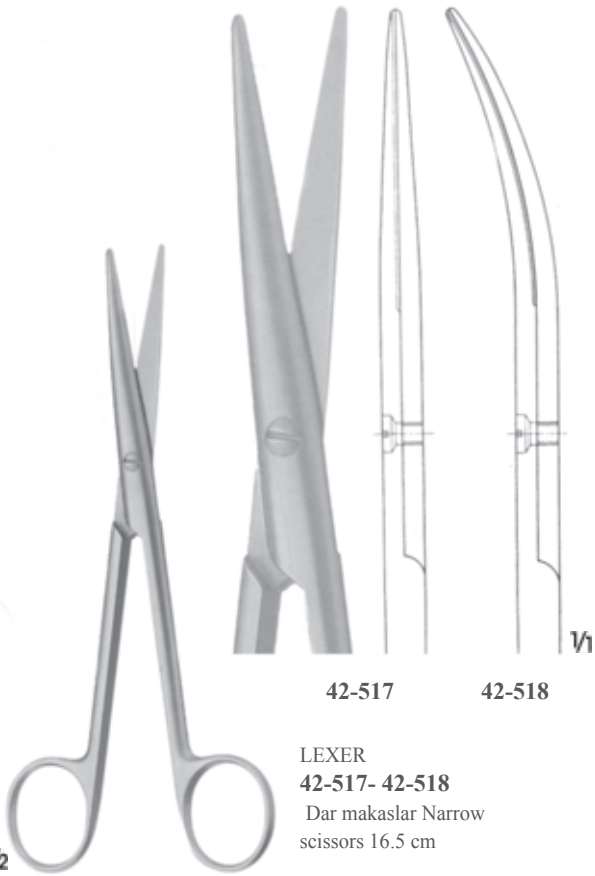
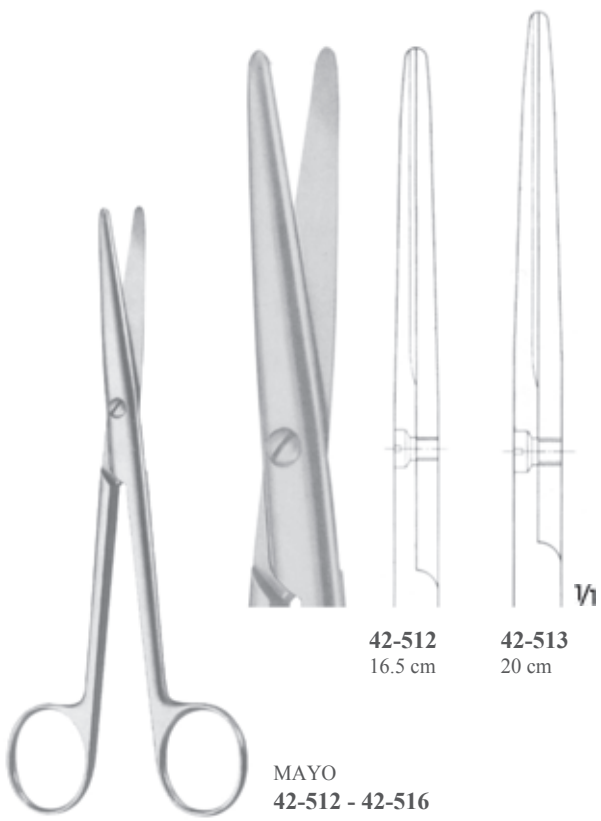


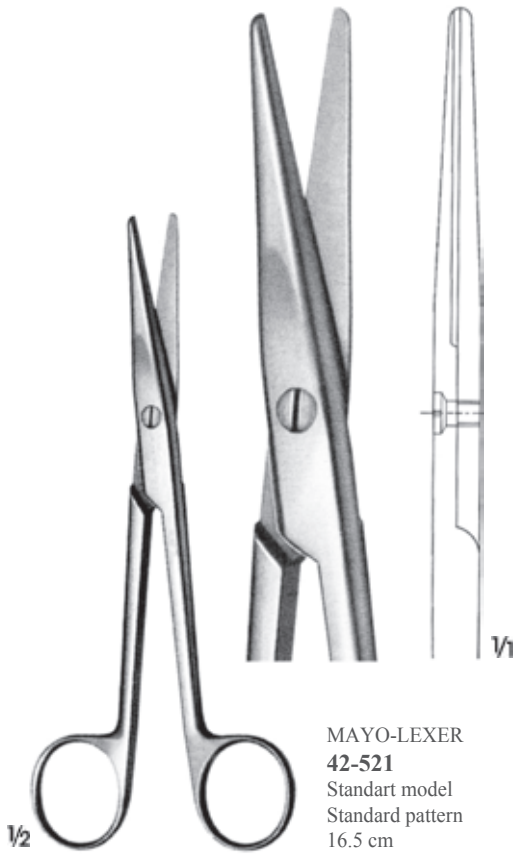
**42-511**  
17 cm

MAYO-STILLE  
**42-508 - 42-511**  
Uc kısmı oyuk yapraklı  
With chamfered blades

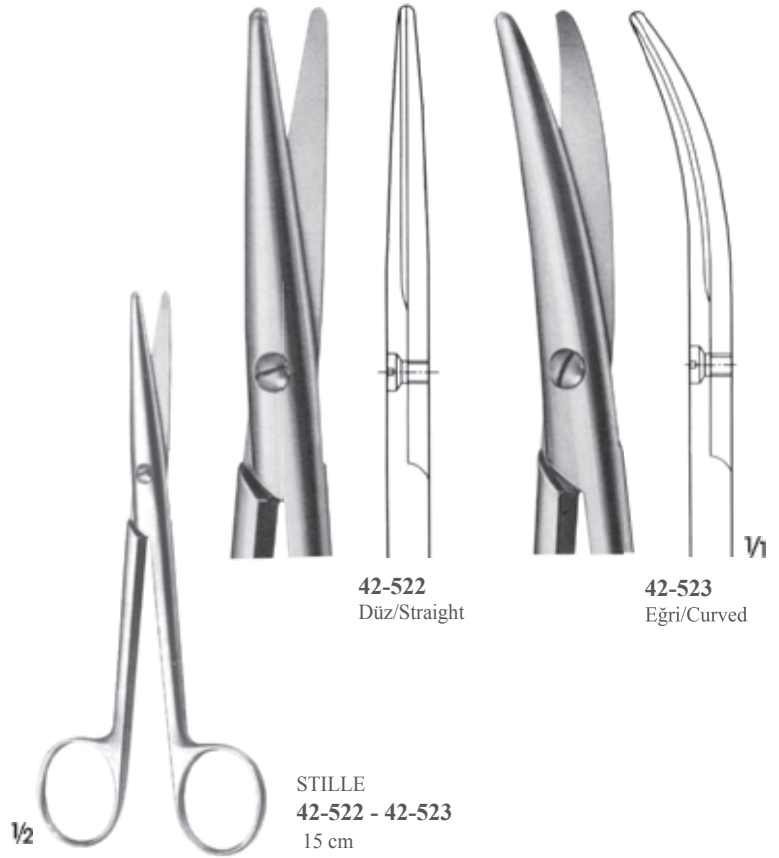








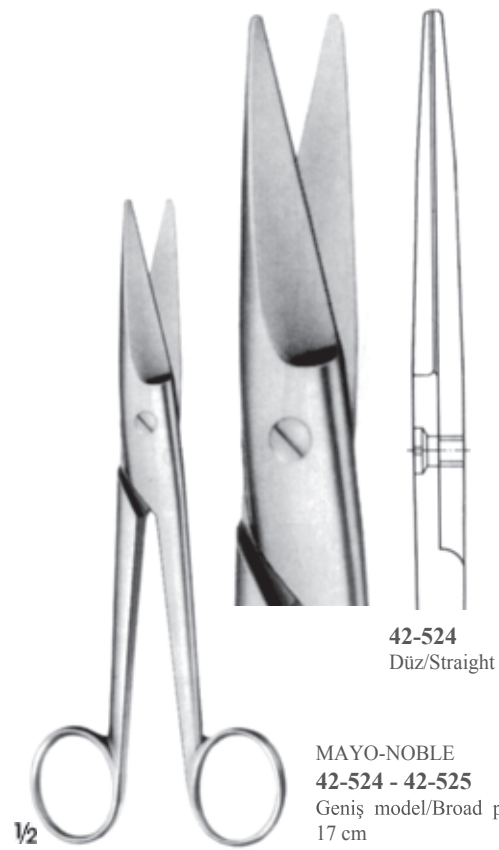
MAYO-LEXER  
42-521  
Standart model  
Standard pattern  
16.5 cm



STILLE  
42-522 - 42-523  
15 cm

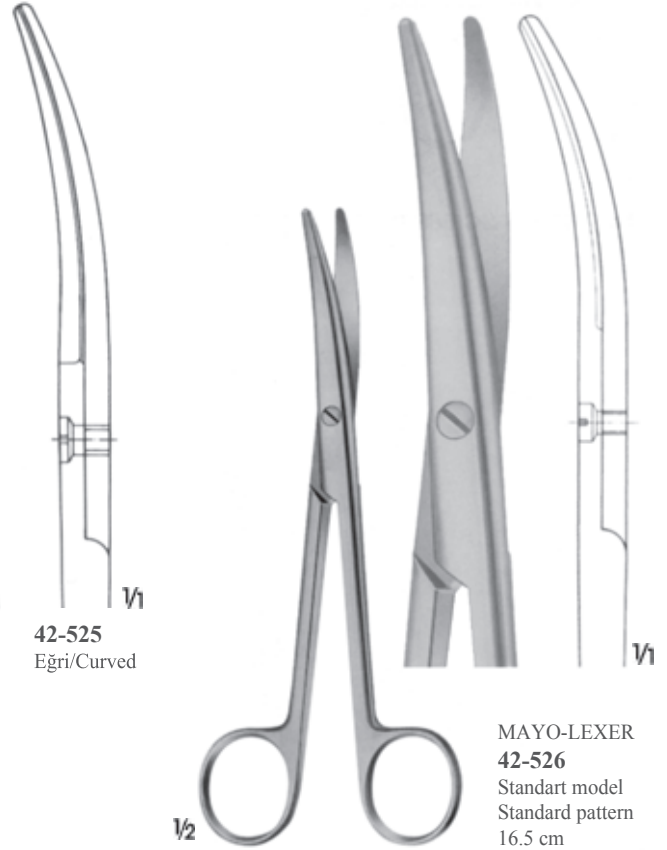
42-522  
Düz/Straight

42-523  
Eğri/Curved



MAYO-NOBLE  
42-524 - 42-525  
Geniş model/Broad patterns  
17 cm

42-524  
Düz/Straight



MAYO-LEXER  
42-526  
Standart model  
Standard pattern  
16.5 cm

42-525  
Eğri/Curved





MAYO-STILLE  
42-529 - 42-532



42-529  
Düz/Straight  
14 cm



42-530  
Düz/Straight  
17 cm



42-531  
Eğri/Curved  
14 cm



42-532  
Eğri/Curved  
17 cm

V1



MAYO  
42-533 - 42-538



42-533  
Düz/Straight  
14 cm



42-534  
Düz/Straight  
15.5 cm



42-535  
Düz/Straight  
17 cm



42-536  
Eğri/Curved  
14 cm



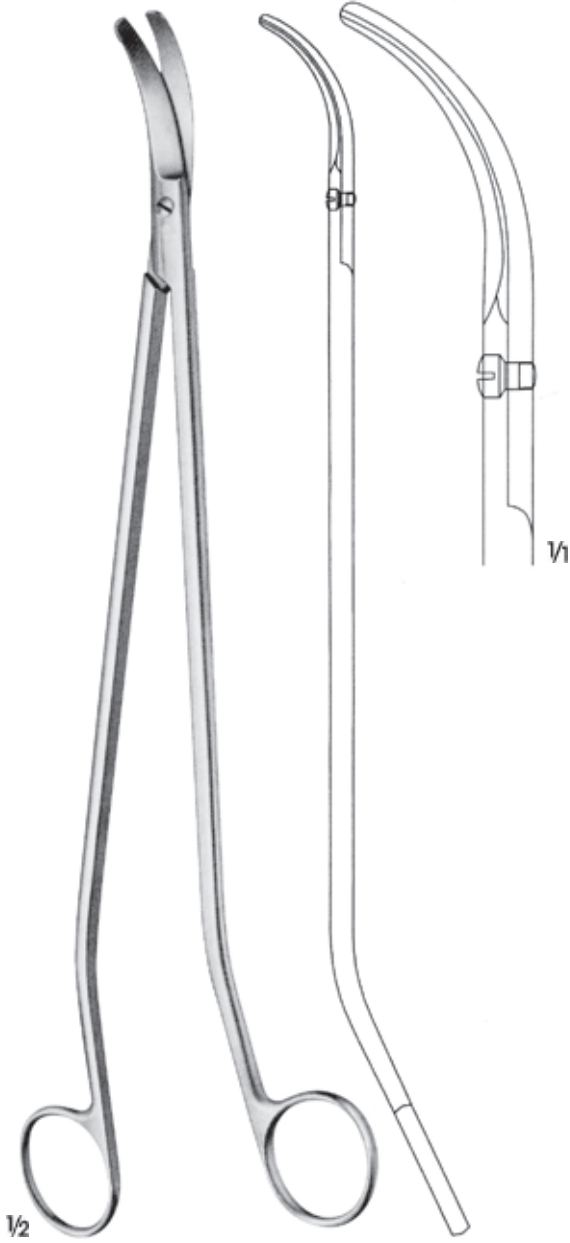
42-537  
Eğri/Curved  
15.5 cm



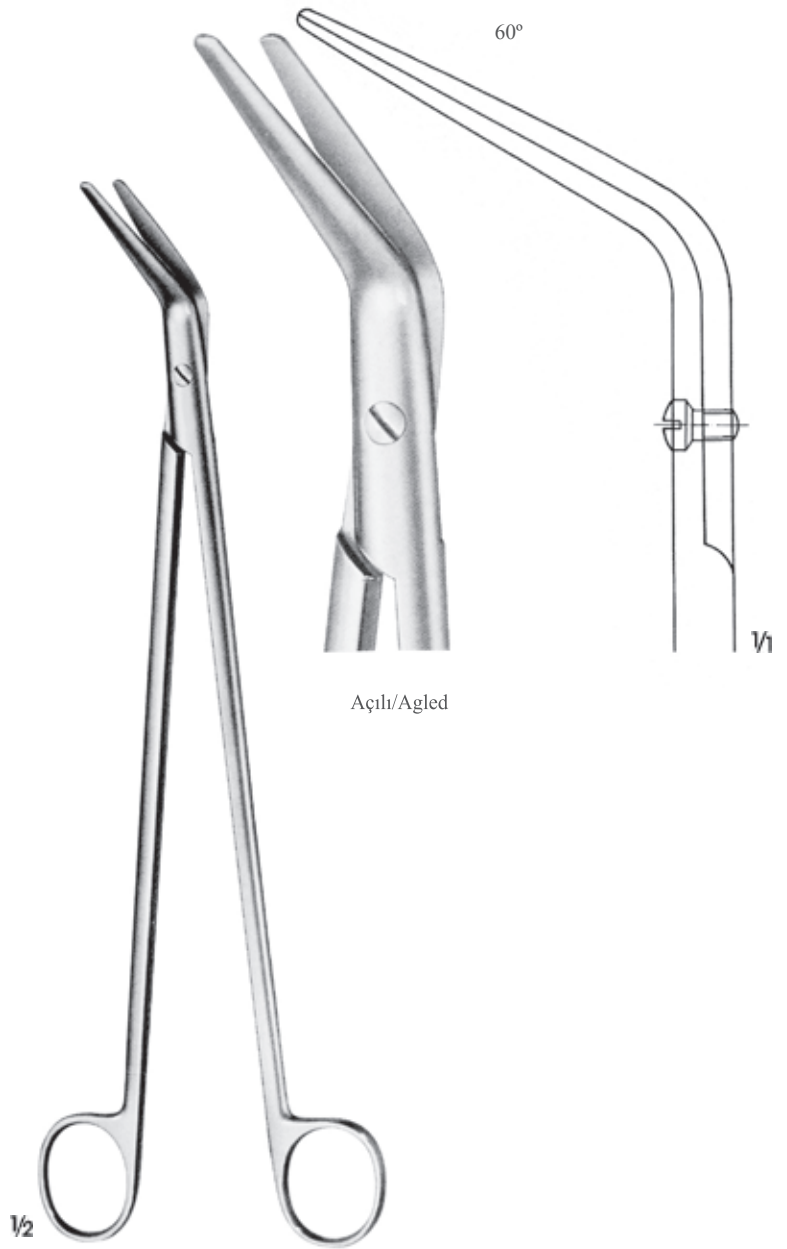
42-538  
Eğri/Curved  
17 cm

V1





**MÜLLER  
42-539**  
Rektal makas/Rectal scissors  
S-şeklinde/S-shaped  
32.5 cm



**42-540**  
Dikiş atıldıktan sonra bağırsak  
kesmek için disseksiyon makası  
Dissecting scissors for cutting  
of the bowel after suturing with  
suture device  
28 cm





1/2

STELZNER  
42-541 - 42-542  
Rektal makas/Rectal  
scissors 31 cm



42-541  
Düz/Straight



42-542  
Eğri/Curved

1/1

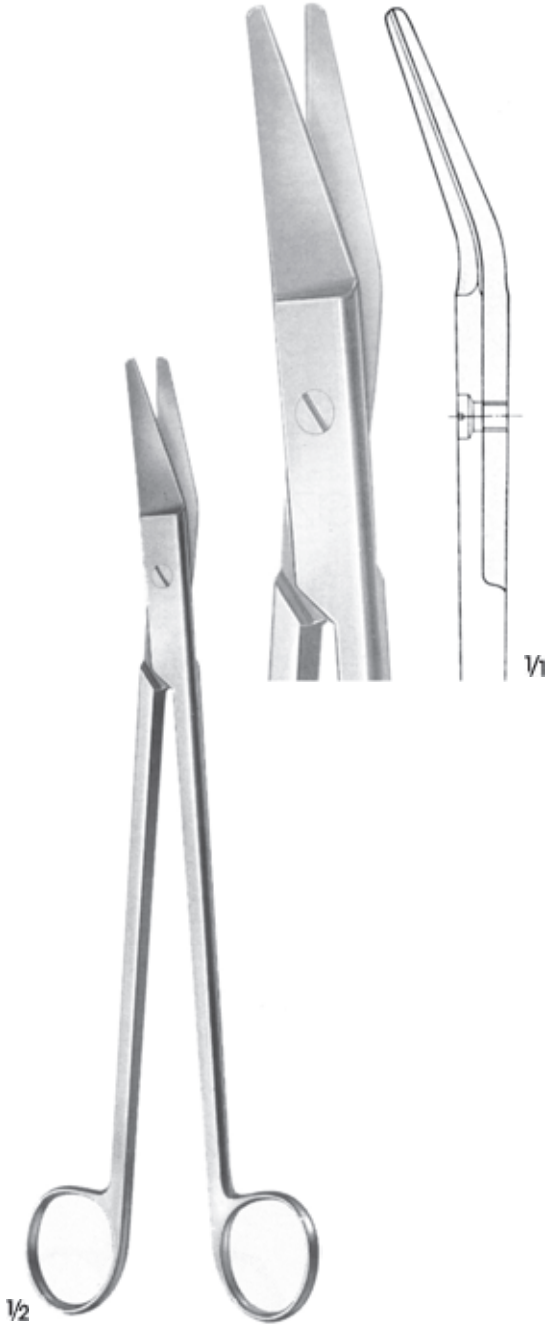


1/2

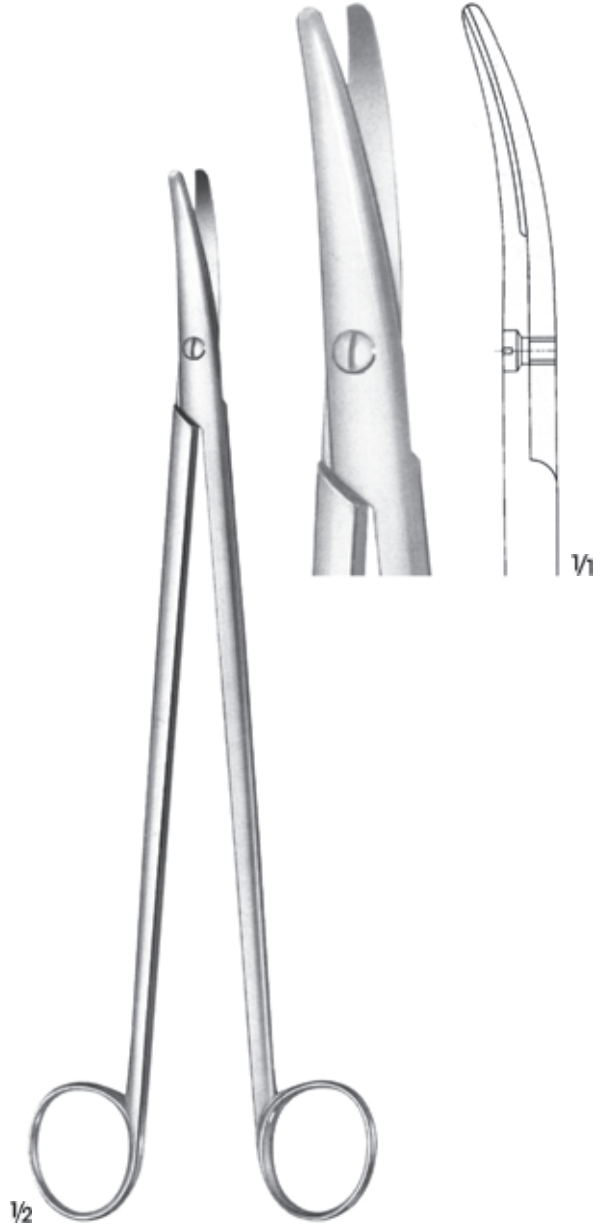
LLOYD-DEVIES(GOLIGHER'S)  
42-543  
Rektal makas/Rectal scissors 25.5  
cm



1/1



RESANO  
42-544  
Kıkırdak makası/Cartilage scissors  
25 cm



WELLER  
42-544  
Diseksiyon makası, zorlu bölgelerde  
Dissecting scissors, heavy pattern  
28 cm





SIMS  
 42-545 - 42-548



42-545  
 20 cm



42-546  
 23 cm



42-547  
 20 cm



42-548  
 23 cm



SIMS  
 42-549 - 42-552



42-549  
 20 cm



42-550  
 23 cm



42-551  
 20 cm



42-552  
 23 cm







V1

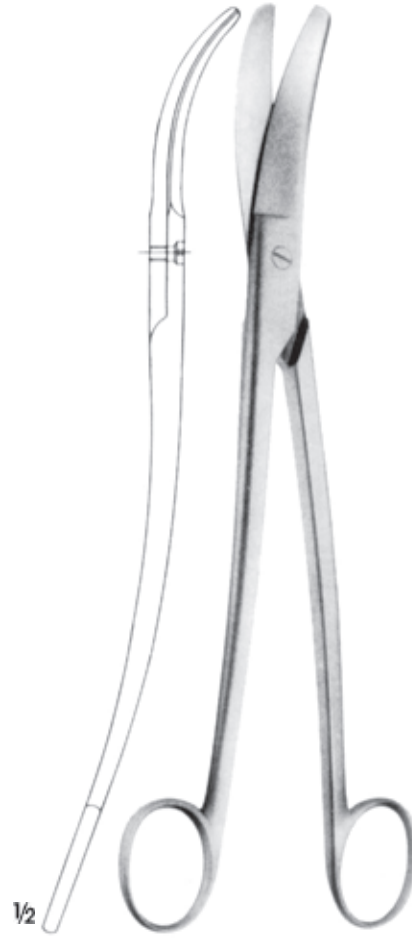


V1



1/2

**BOZEMANN**  
**42-553**  
Rahim makası/Uterine scissors  
22 cm



1/2

**SIEBOLD**  
**42-554**  
Rahim makası/Uterine scissors  
24.5 cm

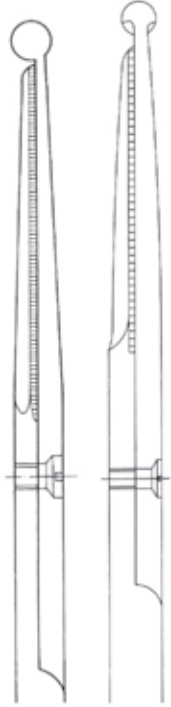




**KEIBACK**  
**42-555 - 42-556**  
Parametrium makasları, yana kavisli,  
tek ağzı sonda uçlu  
Parametrium scissors, curved to side,  
with one probe pointed blade



**42-555**  
26 cm



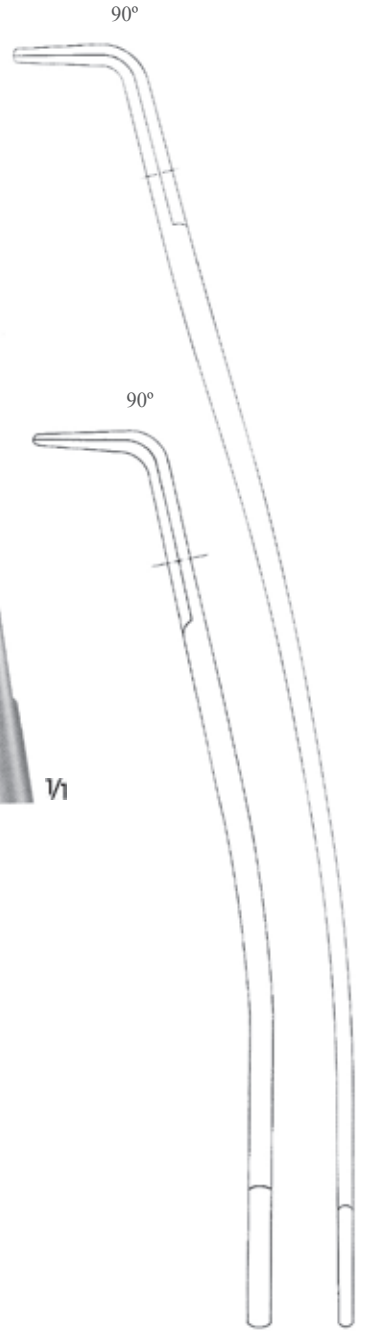
**42-556**  
35 cm



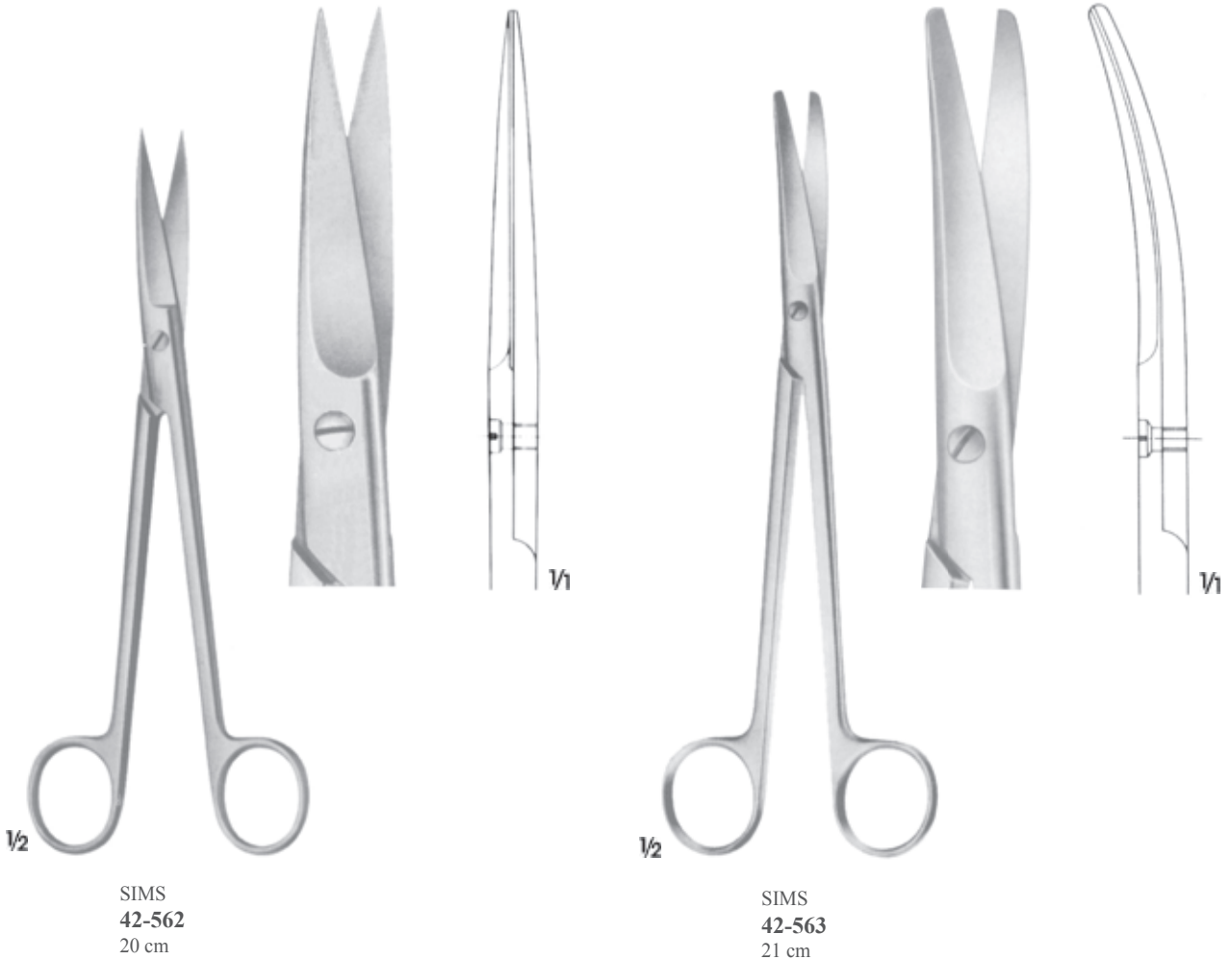
**KEIBACK**  
**42-557- 42-558**  
Parametrium makası  
Parametrium scissors



**42-557**  
24 cm



**42-558**  
35 cm





DUBOIS  
42-564 - 42-565  
Embriyo makası/Embriyo scissors  
27.5 cm



42-564  
Düz/Straight

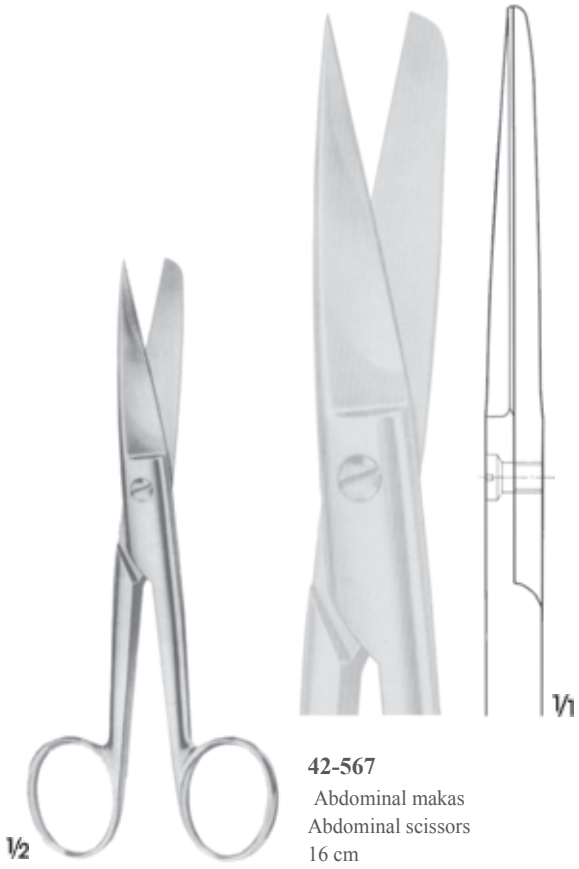


42-565  
Eğri/Curved



SIMS SIEBOLD  
42-566  
Rahim makası/Uterine scissors  
25 cm





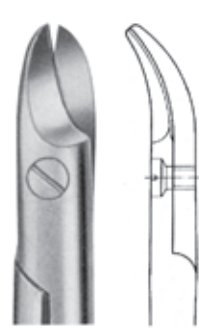


1/2

BEEBE  
42-571 - 42-574  
11 cm



42-571 42-572



42-573  
Geniş ağız bleyd  
Broad blades



42-574  
Tek ağız tırtıllı  
One jaw serrated

1/1



1/2

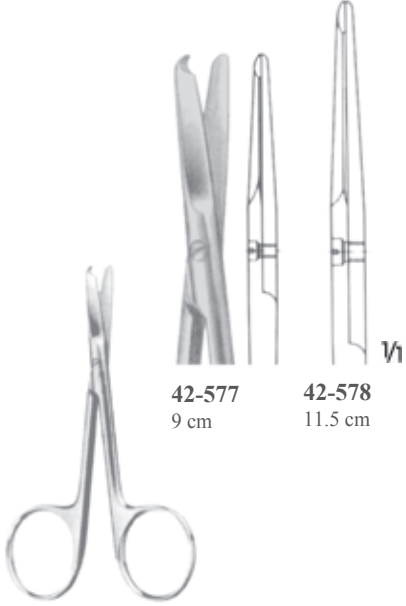
42-575  
Tek ağız tırtıllı  
One jaws serrated  
12 cm



1/2

HARVEY  
42-576  
Çift ağız tırtıllı  
Both jaws serrated  
12.5 cm

1/1



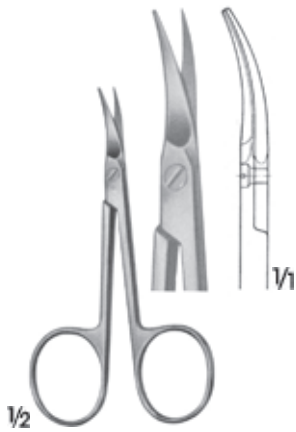
SPENCER  
42-577 - 42-578  
Ligatür makası  
Ligature scissors



LITTAUER  
42-579  
Ligatür makası  
Ligature scissors  
13.5 cm



NORTHBENT  
42-580  
Ligatür makası  
Ligature scissors  
12 cm



42-581  
Tırnak makası  
Nail scissors  
9 cm



42-582  
Hassas bölge için tırnak makası  
Nail Scissors, especially delicate  
pattern  
9 cm



42-583  
Çocuk tırnak makası  
Baby nail scissors  
8.5 cm

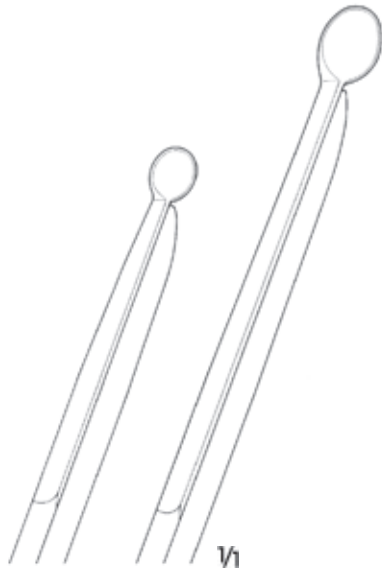




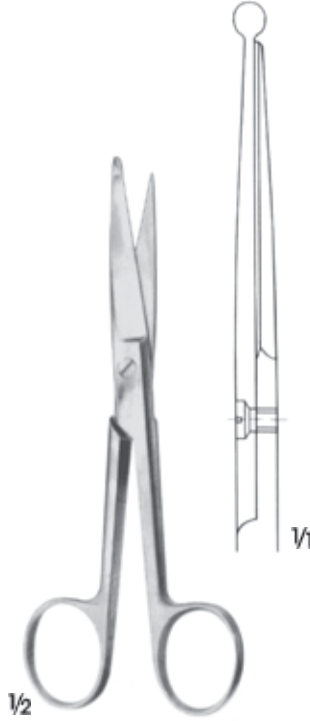


42-584  
15.5 cm

KNOWLES  
42-584 - 42-585

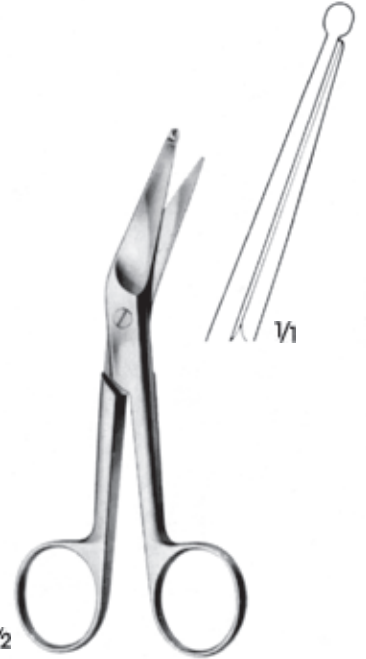


42-585  
18 cm



1/2

KNOWLES  
42-586  
14.5 cm

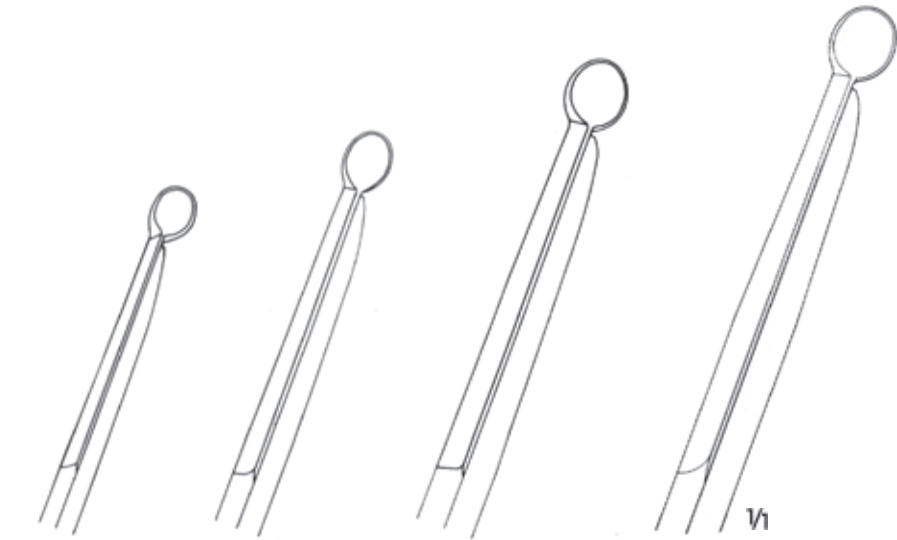


1/2

KNOWLES  
42-587  
14 cm



LISTER  
42-588 - T42-591

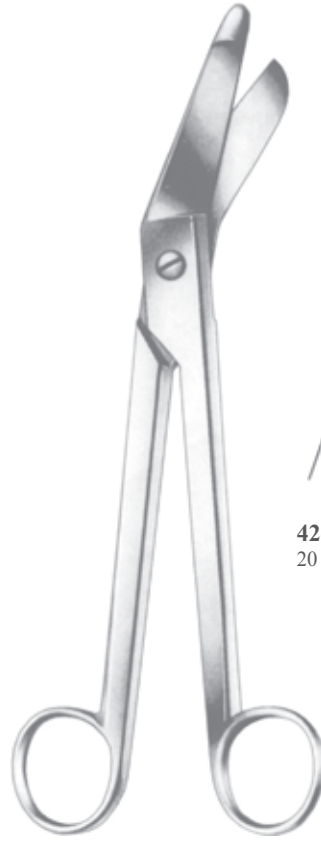


42-588  
11.5 cm

42-589  
14 cm

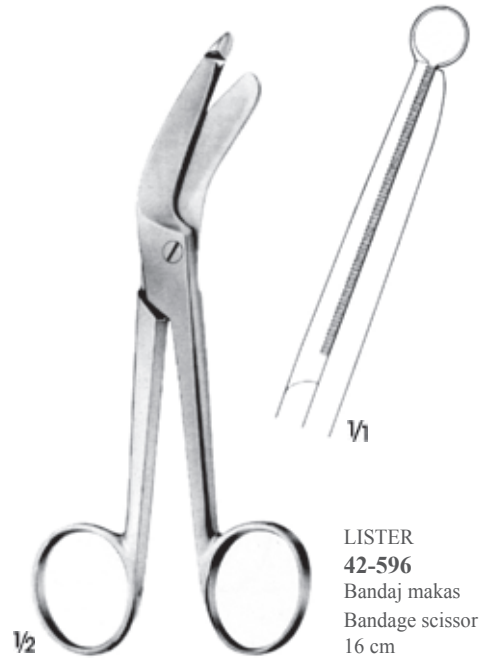
42-590  
18 cm

42-591  
20 cm



42-593  
20 cm

42-594  
23 cm





1/2

SCHUMACHER  
42-597  
Göbek kordonu makası  
Umbilical cord scissors  
15.5 cm



1/1

1/2

42-598  
Göbek kordonu makası  
Umbilical cord scissors  
10.5 cm



42-599 - 42-600  
Göbek kordonu makasları  
Umbilical Cord scissors



42-599  
13.5 cm



42-600  
16 cm

1/1



BRAUN-STADLER  
42-601 - 42-602

Epizyotomi makasları/Episiotomy scissors



1/1 **42-601**  
14.5 cm



1/1 **42-602**  
20 cm



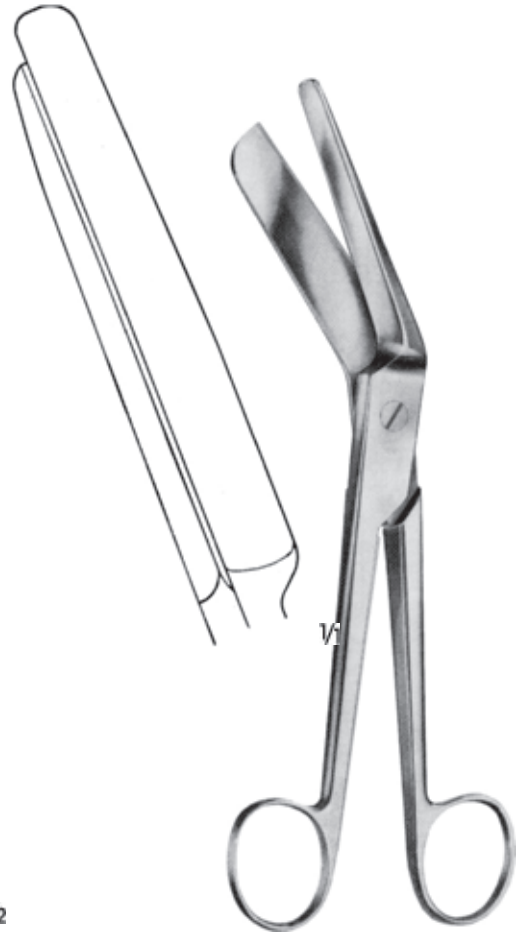
1/2

**42-603**

Epizyotomi makası/Episiotomy scissors  
24 cm



1/1

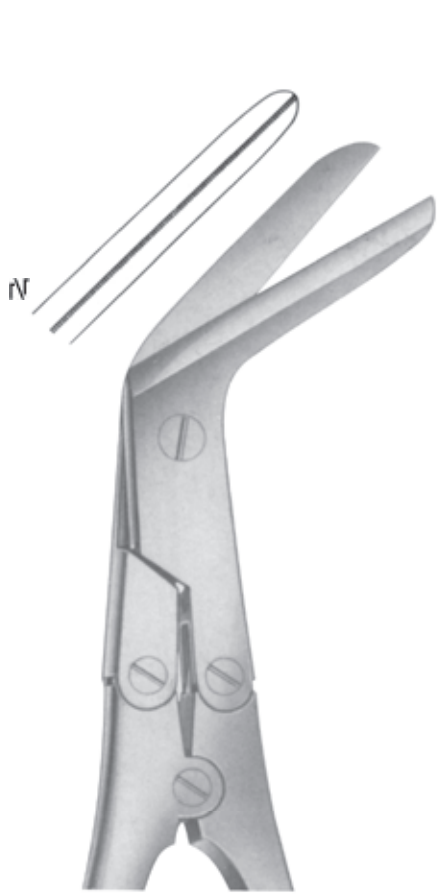


1/2

BRAUN-STADLER  
**42-604**

Bandaj makası/Bandage scissor  
22.5 cm



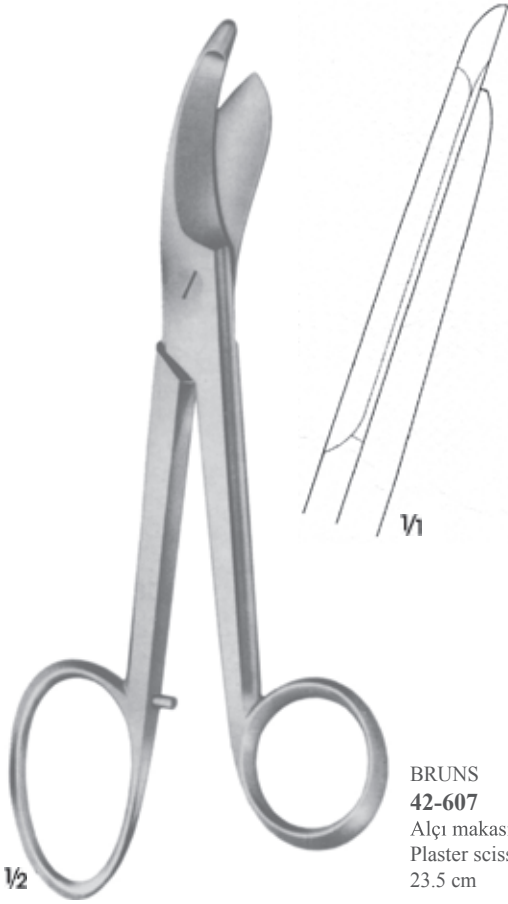


**KILLIAN**  
**42-605**  
İki taraflı dişli makas  
Both jaws serrated  
20 cm

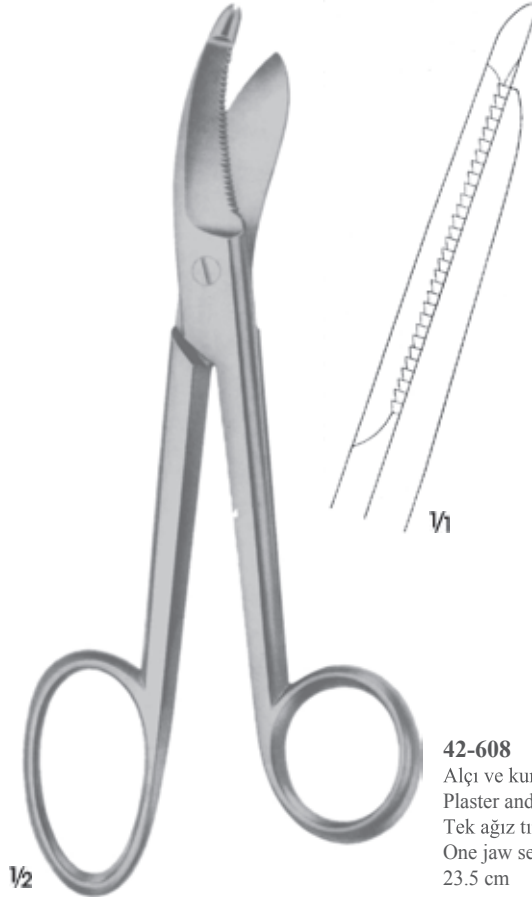


**MUHLING**  
**42-606**  
21 cm





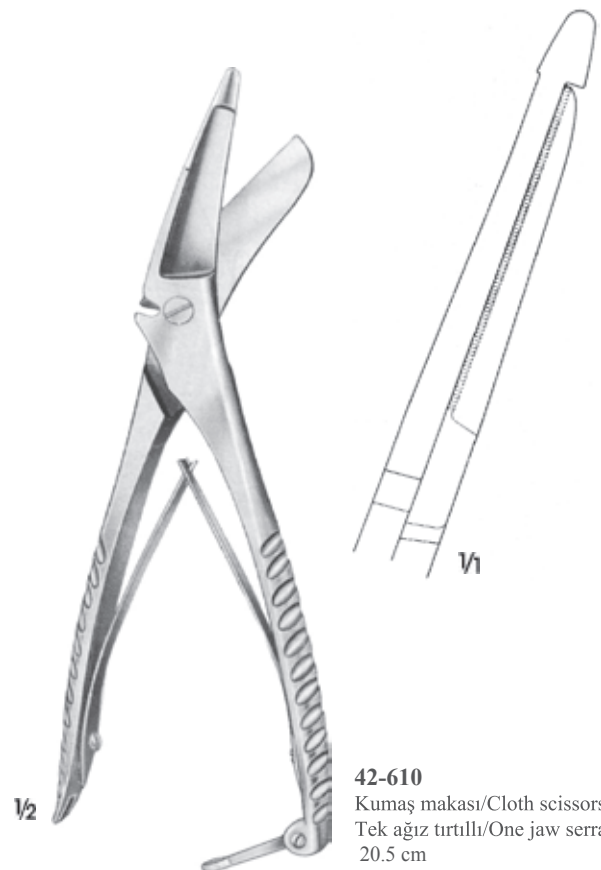
BRUNS  
42-607  
Alçı makası  
Plaster scissors  
23.5 cm



42-608  
Alçı ve kumaş kesme makası  
Plaster and cloth scissors  
Tek ağız tırtıllı  
One jaw serrated  
23.5 cm



SEUTIN  
42-609  
Bandaj makası/Bndage scissors  
Tek ağız tırtıllı/One jaw serrated  
23 cm



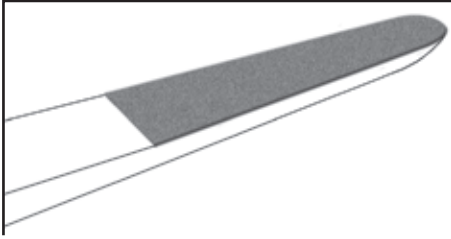
42-610  
Kumaş makası/Cloth scissors  
Tek ağız tırtıllı/One jaw serrated  
20.5 cm







**43**



**DIAMOTE** ağızlar, daha sert ve aşınmaya dayankılı yüzeyler sağlar.  
**DIAMOTE** ağızlar, hassas iğne, suture ve dokuların güvenilir bir şekilde kavranmasını garanti eder.

**DIAMOTE** jaws provide harder and more wear resistant surfaces.  
**DIAMOTE** jaws ensure reliable grip of fine needles, sutures and tissues.

Ø 1.2 mm



**43-100**  
18 cm



**43-101**  
22 cm

Ø 1.2 mm



Ø 1.0 mm



18.5 cm  
21 cm

**43-102**  
**43-103**

Platform tip, düz  
Platform tip, straight

Ø 1.0 mm



**43-104**  
**43-105**

Düz/Straight

Ø 1.0 mm



**43-106**  
**43-107**

Eğri/Curved

Ø 1.0 mm



15 cm  
18.5 cm  
21 cm  
23 cm  
25 cm

**43-108**  
**43-109**  
**43-110**  
**43-111**  
**43-112**

Düz/Straight

Ø 2.0 mm



**43-113**  
**43-114**  
**43-115**  
**43-116**  
**43-117**

Düz/Straight

Ø 1.0 mm



**43-118**  
**43-119**  
**43-120**  
**43-121**  
**43-122**

Eğri/Curved

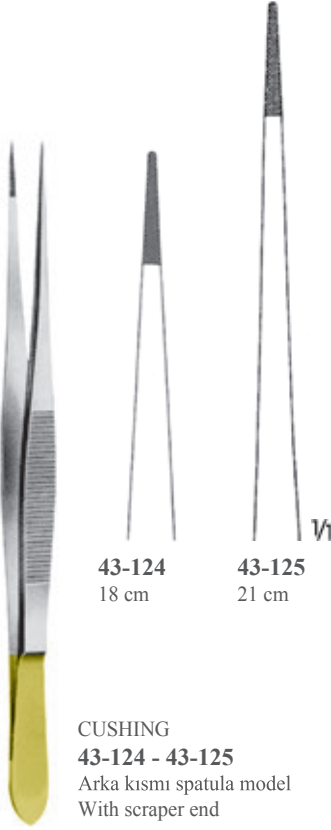
**43-102-43-107**

**43-108-43-122**

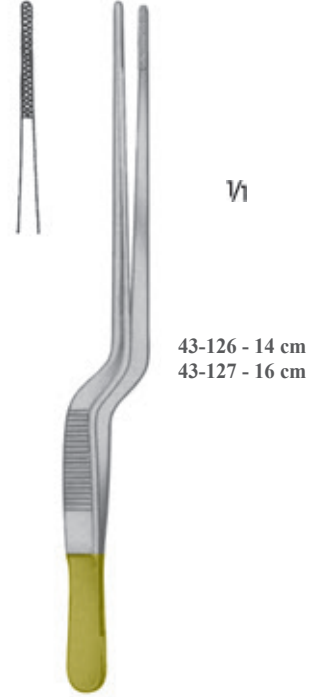




**GRUENWALD**  
**43-123**  
Diseksiyon  
pensetler Dissecting  
forceps 18.5 cm



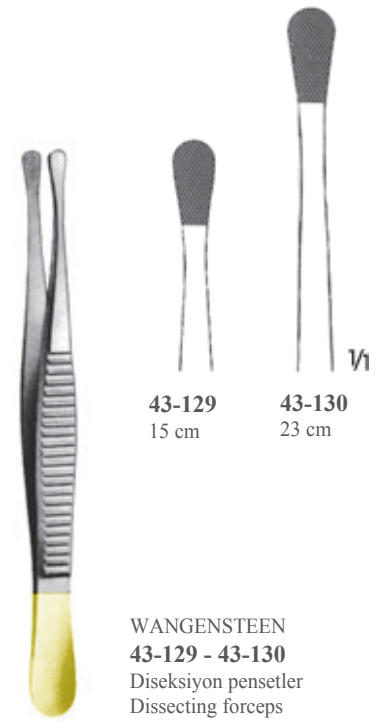
**CUSHING**  
**43-124 - 43-125**  
Arka kısmı spatula model  
With scraper end



**43-126 - 14 cm**  
**43-127 - 16 cm**



**FERRIS-SMITH**  
**43-128**  
Diseksiyon  
pensetler Dissecting  
forceps 17.5 cm



**43-129**  
15 cm

**43-130**  
23 cm

**WANGENSTEEN**  
**43-129 - 43-130**  
Diseksiyon pensetler  
Dissecting forceps



18.5 cm **43-131**  
21 cm **43-132**  
Platform tip, düz  
Platform tip, straight



**43-131 - 43-132**  
Yuvarlak sap/Round handle



15 cm **43-133**  
18.5 cm **43-134**  
21 cm **43-135**  
25 cm **43-136**  
Platform tip, düz  
Platform tip, straight



**43-133 - 43-139**  
Yuvarlak sap/Round handle



**43-137**  
**43-138**  
**43-139**  
**43-140**  
Platform tip, eğri  
Platform tip, curved



**43-141**  
Platformlu  
With plateau

**WACHTEL**  
**43-141**  
diseksiyon penset,  
yuvarlak sap Micro  
dissecting forceps, round  
handle  
18 cm



**43-142**  
Ø 1.0 mm  
Düz/Straight

**43-142**  
**43-143** Düz sap/Flat  
handle 18 cm



18 cm **43-144**  
20 cm **43-145**  
1.0 mm  
Düz/Straight

**43-144**  
**43-145**  
Düz sap/Flat handle



**43-146**  
1 mm  
1 x 2 diş  
1 x 2 teeth

**43-146- 43-147**  
Dişli doku pensetleri,  
düz sap  
Mikro tissue forceps  
flat handle  
18 cm



**43-148**  
Düz  
1 x 2 diş  
Straight  
1 x 2 teeth

**WACHTEL**  
**43-148 - 43-149**  
Mikro dişli doku pensetleri  
yuvarlak sap  
Mikro tissue forceps  
round handle  
18 cm

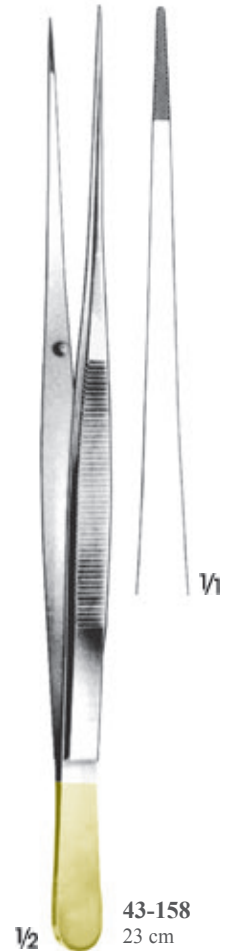
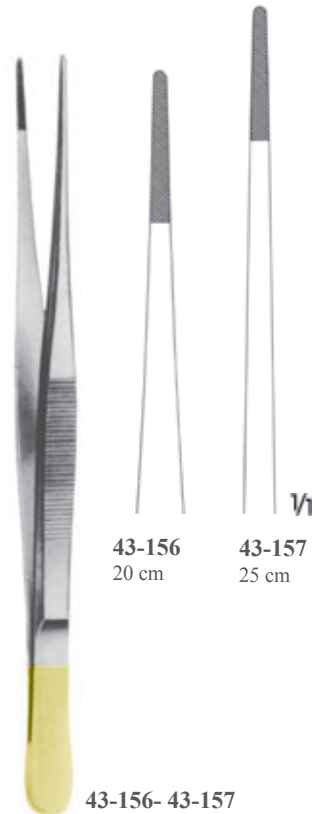
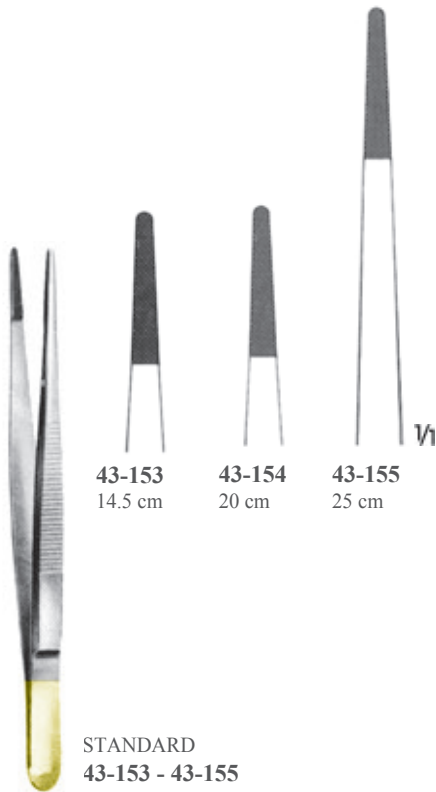
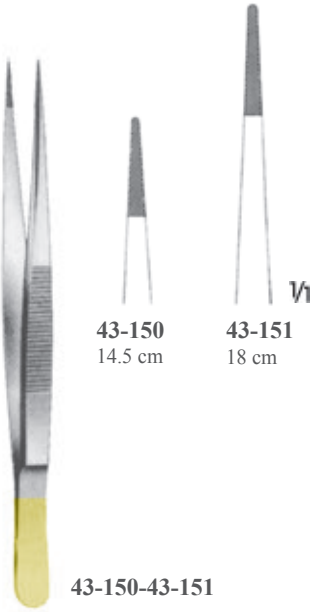
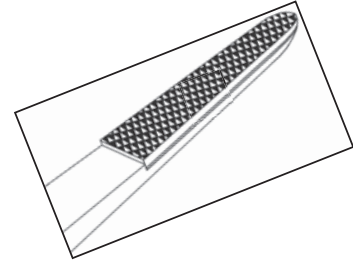


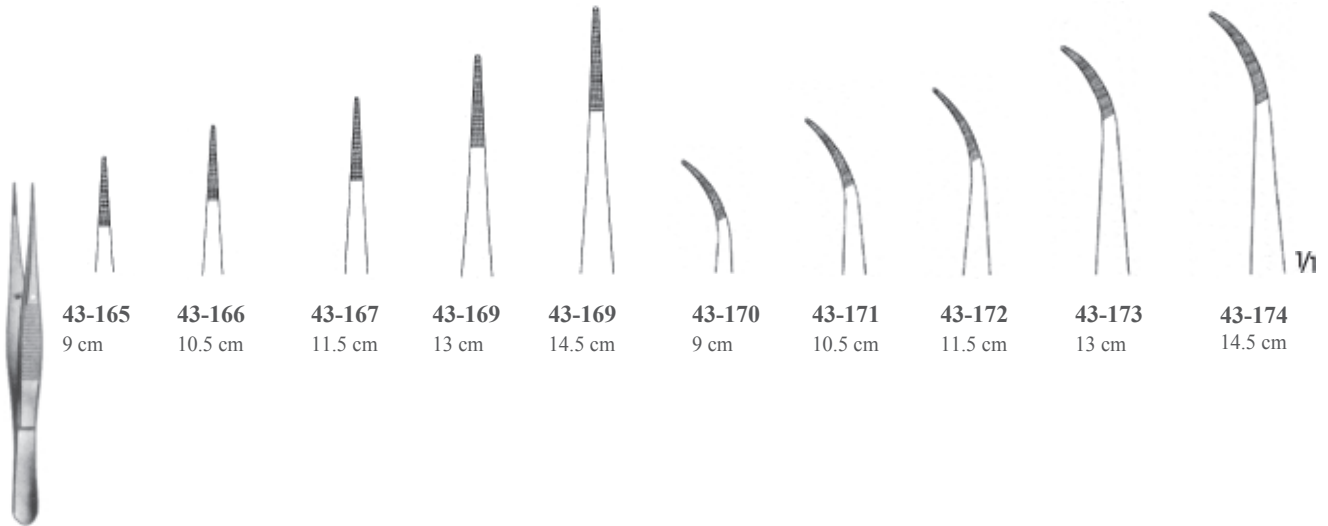
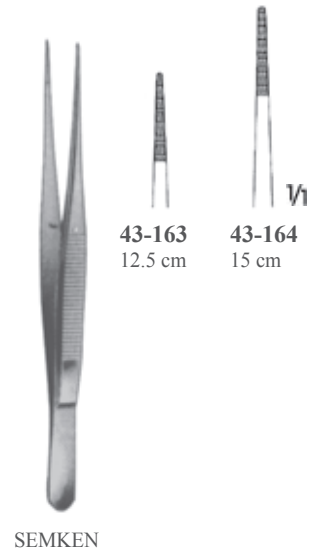
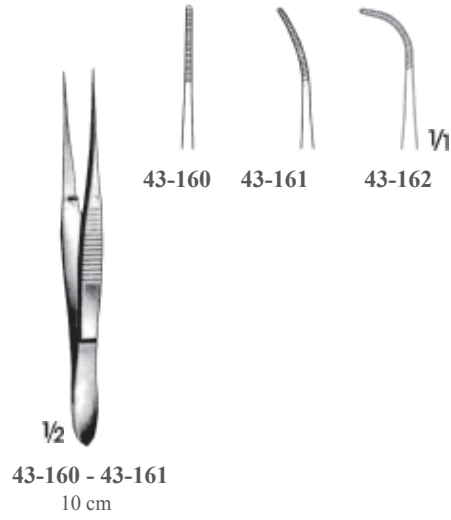
Karbid uclu Diseksiyon Pensleri

- Ince yapılı karbid ucu sayesinde verimli kullanım...
- Sıkı şekilde ve dokuya zarar vermeden kavrama...
- Çok amaçlı kullanım
- Uzun çalışma süresi

Carbide-tipped dissecting forceps

- Due-to slender carbide tip, efficient use
- Tight gripping without damaging the tissue
- Multi-purpose use
- Long working life







**43-175 - 43-182**  
Orta/Medium

**43-175**  
11.5 cm



**43-176**  
13 cm



**43-177**  
14.5 cm



**43-178**  
16 cm



**43-179**  
18 cm



**43-180**  
20 cm



**43-181**  
25 cm



**43-182**  
30.5 cm



Vi



**43-183 - 43-190**  
Standart model/Standard pattern

**43-183**  
11.5 cm



**43-184**  
13 cm



**43-185**  
14.5 cm



**43-186**  
16 cm



**43-187**  
18 cm



**43-188**  
20 cm



**43-189**  
25 cm

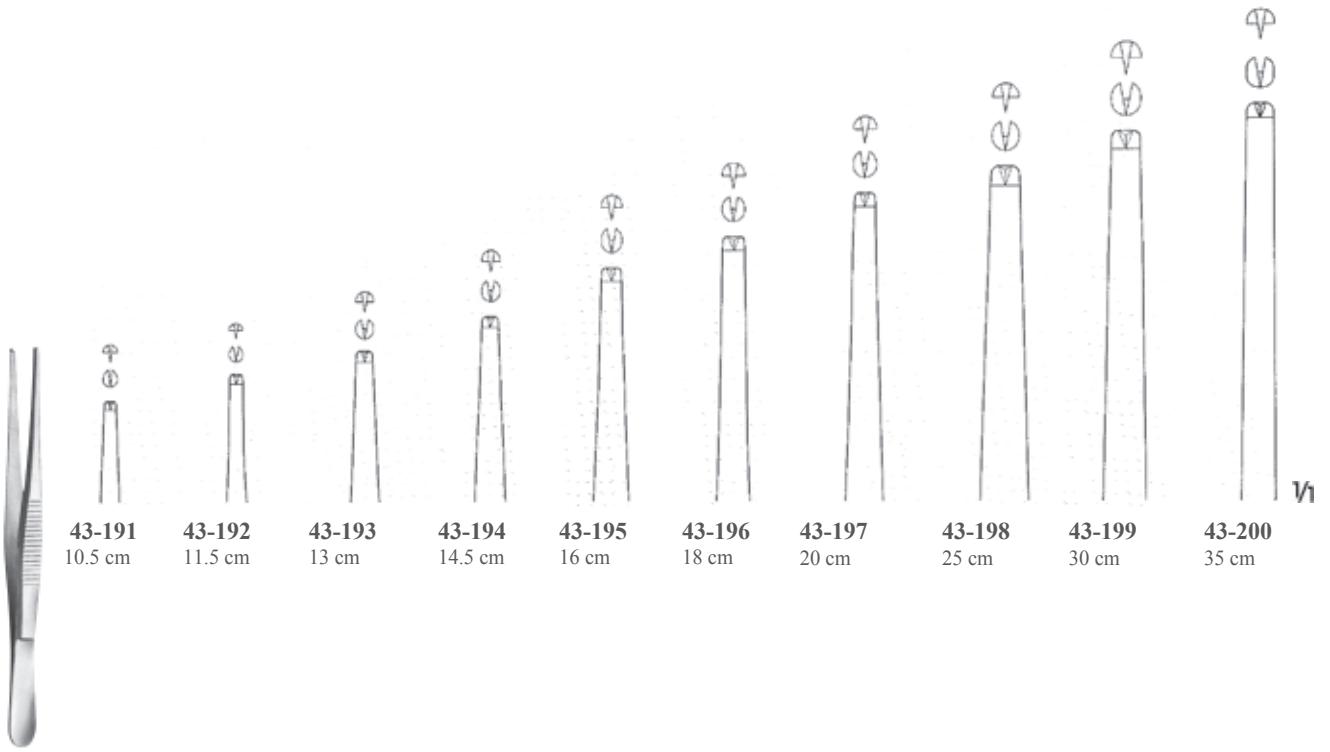


**43-190**  
30 cm



Vi





**43-191**  
10.5 cm

**43-192**  
11.5 cm

**43-193**  
13 cm

**43-194**  
14.5 cm

**43-195**  
16 cm

**43-196**  
18 cm

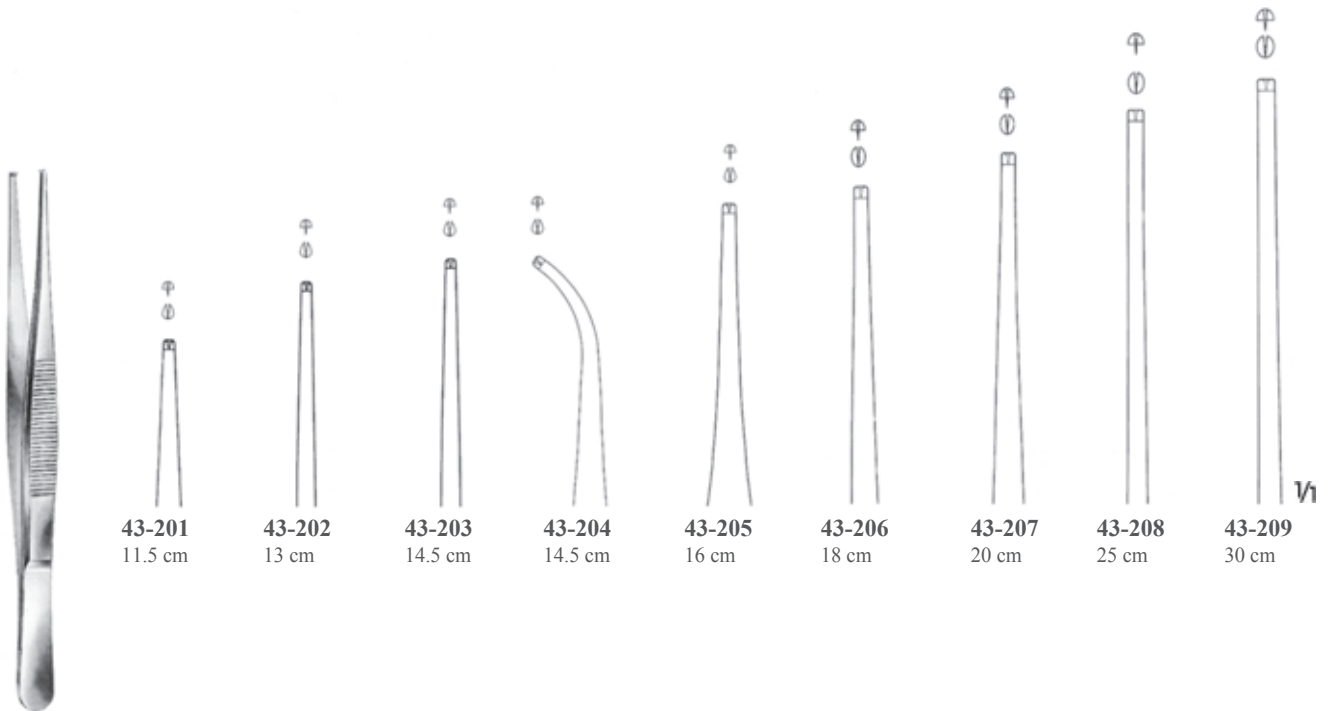
**43-197**  
20 cm

**43-198**  
25 cm

**43-199**  
30 cm

**43-200**  
35 cm

**43-191 - 43-200**  
Satandard model  
Standard modelle



**43-201**  
11.5 cm

**43-202**  
13 cm

**43-203**  
14.5 cm

**43-204**  
14.5 cm

**43-205**  
16 cm

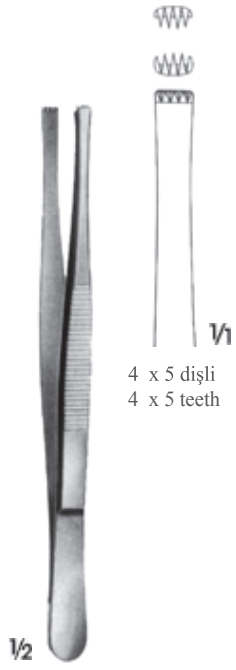
**43-206**  
18 cm

**43-207**  
20 cm

**43-208**  
25 cm

**43-209**  
30 cm

**43-201 - 43-209**  
Orta boy/medium



**43-210**  
14.5 cm

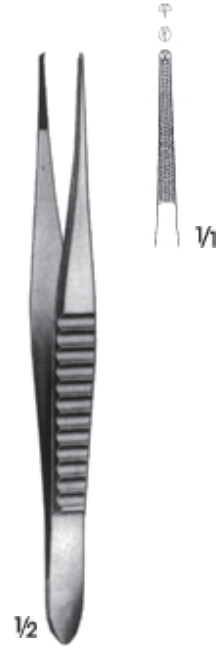
4 x 5 dişli  
4 x 5 teeth



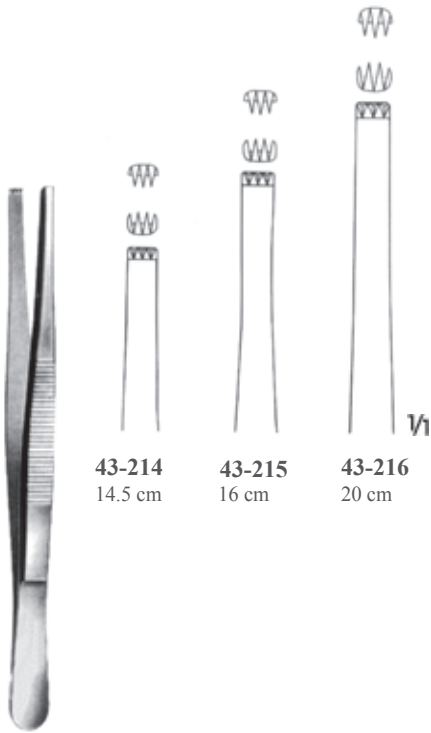
**43-211**  
Güçlü model/Heavy Pattern  
14.5 cm



MC INDOE  
**43-212**  
15 cm



GILLIES  
**43-213**  
15.5 cm

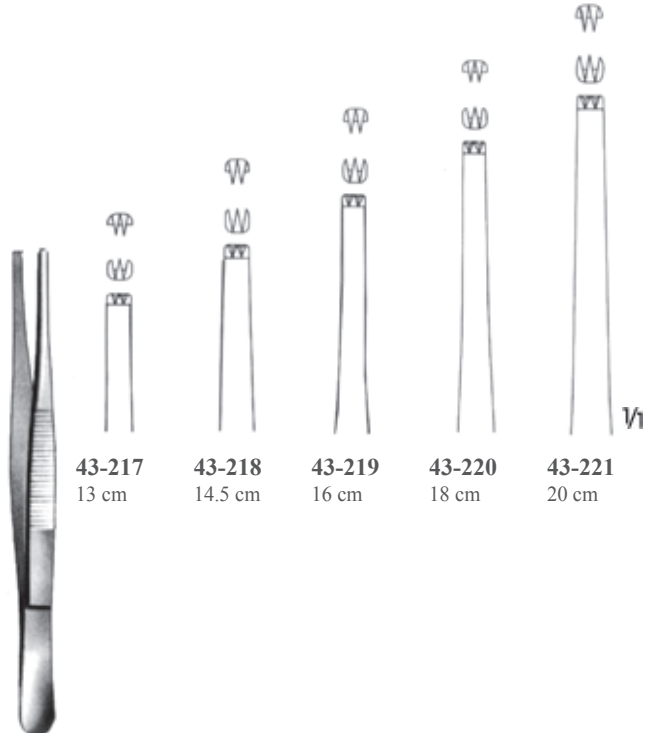


**43-214**  
14.5 cm

**43-215**  
16 cm

**43-216**  
20 cm

3 x 4 diş/3 x 4 teeth



**43-217**  
13 cm

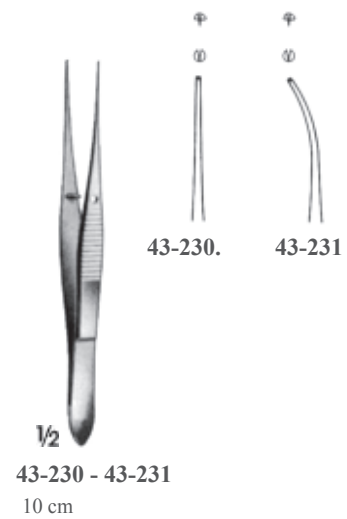
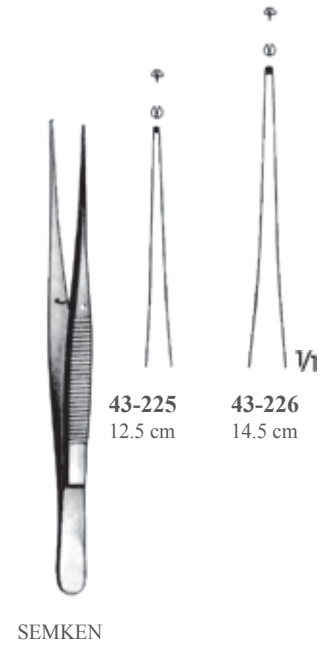
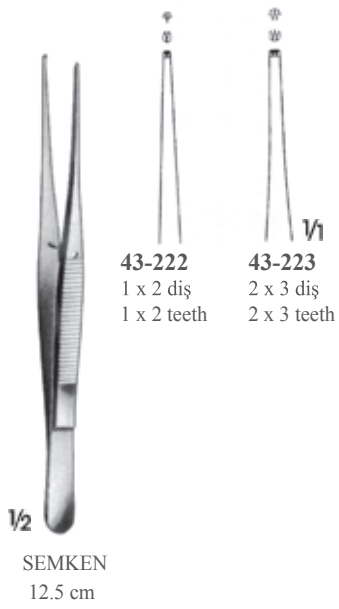
**43-218**  
14.5 cm

**43-219**  
16 cm

**43-220**  
18 cm

**43-221**  
20 cm

2 x 3 diş/2 x 3 teeth

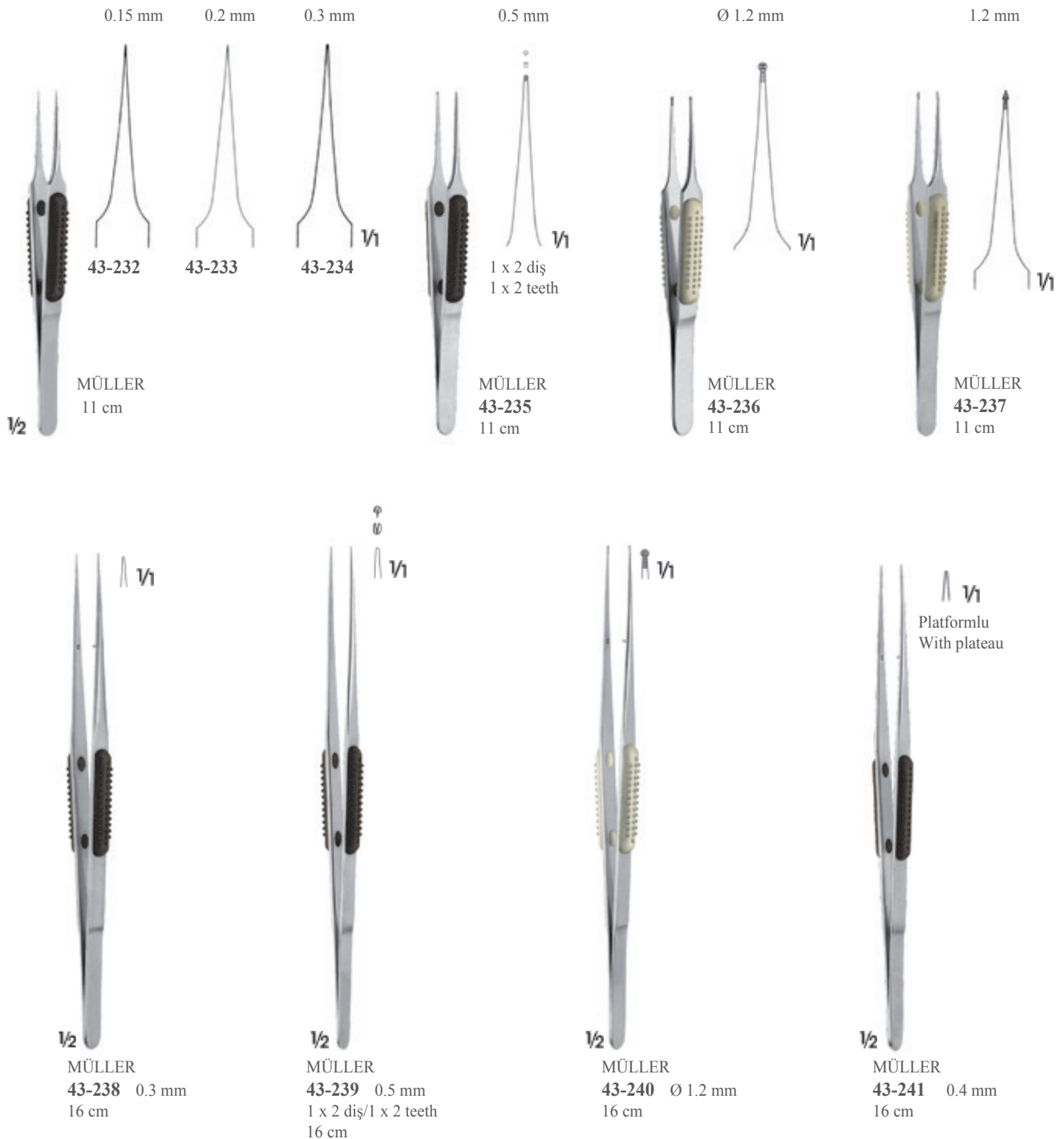


Kavrama yüzeyini artıran hafif plastik tutamak :

- Kramp oluşturmeyan, doğal tutma pozisyonu ve duyarlılık sağlar.
- Yuvarlak tutma kesiti aletin kolay ve düzgün rotasyonunu sağlar. Böylelikle uygulama ve çalışma alanı genişler.
- Pimli tutma profili güvenli tutmayı garanti eder.
- Ergonomik, hafif plastik sap yorulmadan optimum kullanım sağlar.

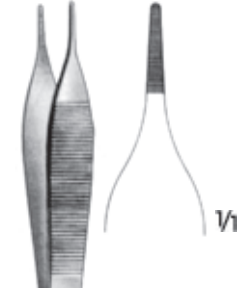
Lightweigh plastic handles to increase grip surface:

- Provides cramp free ,natural holding positions and sensitivity
- Round cross-section of the instrument provides an easy and smooth rotation.Expands the working and application area.
- Retention profile with pin ensures safe gripping.
- Ergonomic, light weight plastic handle provides fatigue free, optimal usage.





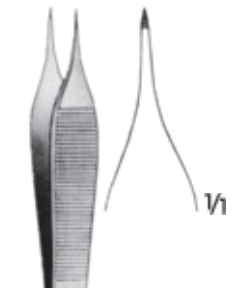
**1/2**  
MICRO-ADSON  
43-242  
12 cm



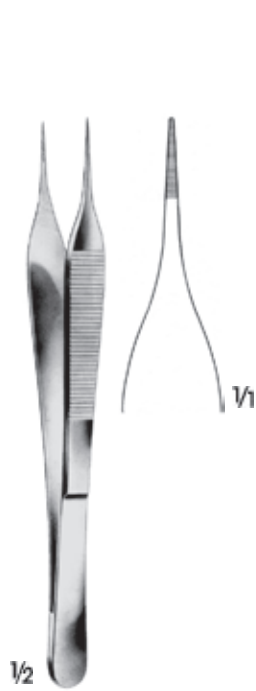
**1/2**  
ADSON  
43-243  
12 cm



**1/2**  
HUDSON  
43-244  
12.5 cm



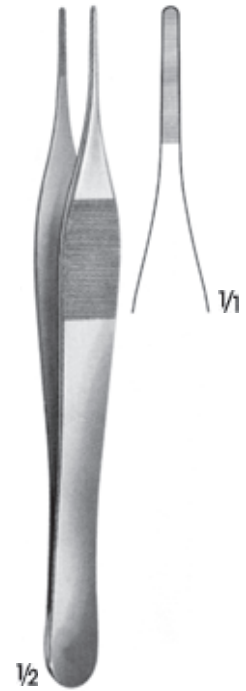
**1/2**  
THORPE  
43-245  
Korneal penset  
Corneal forceps  
12 cm



**1/2**  
MICRO-ADSON  
43-246  
15 cm



**1/2**  
ADSON  
43-247  
18 cm



**1/2**  
JEFFERSON  
43-248  
18 cm



**43-249**  
Hassas diseksiyon penseti  
Delicate dissecting forceps  
10 cm



**43-250**  
Hassas diseksiyon penseti  
Delicate dissecting forceps  
10 cm



**43-251**  
Hassas diseksiyon penseti  
Delicate dissecting forceps  
10 cm



**43-252**  
Mikro penset  
Micro forceps  
11.5 cm



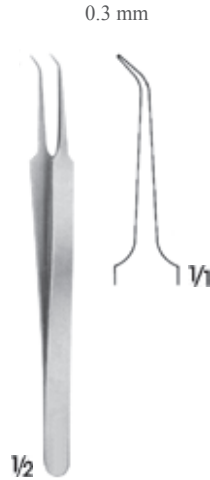
**43-253**  
Mikro penset  
Micro forceps  
1 x 2 diş  
1 x 2 teeth  
11.5 cm



**43-254**  
Mikro penset  
Micro forceps  
11 cm



**43-255**  
Mikro penset  
Micro forceps  
11 cm



**43-256**  
Mikro penset  
Micro forceps  
11 cm

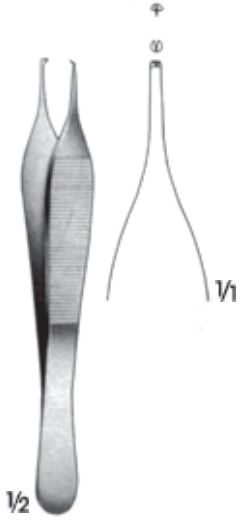


**43-257**  
Mikro penset  
Micro forceps  
13.5 cm



**43-258**  
Mikro penset  
Micro forceps  
1 x 2 diş/1 x 2 teeth  
13.5 cm





**ADSON  
43-259**  
Hassas doku penseti  
Delicate tissue forceps  
12 cm



**ADSON  
43-260**  
Hassas doku penseti  
Delicate tissue forceps  
12 cm

Dişli platform  
With plateau

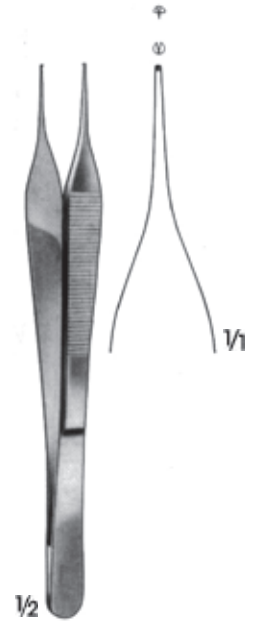


**HUDSON  
43-261**  
Doku penseti  
Tissue forceps  
12.5 cm



**ADSON  
43-262**  
Doku penseti  
Tissue forceps  
12 cm

2 x 3 diş  
2 x 3 teeth



**MICRO-ADSON  
43-263**  
Hassas doku penseti  
Delicate tissue forceps  
15 cm



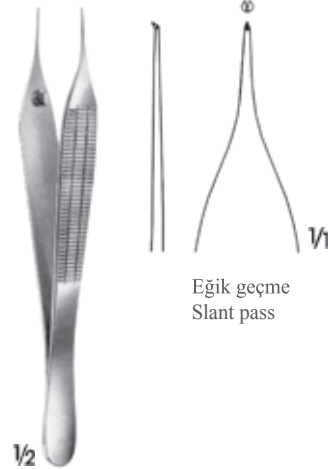
**BISHOP-HARMON  
43-264**  
Hassas göz penseti  
Delicate eye forceps  
8.5 cm



**ST. MARTIN  
43-265**  
Hassas göz penseti  
Delicate eye forceps  
8 cm



**CASTROVIEJO  
43-266**  
Hassas göz penseti  
Delicate eye forceps  
8 cm



**MICRO-ADSON-BIEMER  
43-267**  
Hassas doku penseti  
Delicate tissue forceps  
12 cm

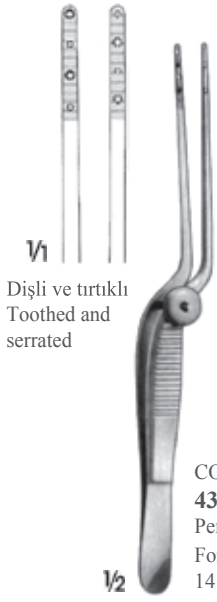
Eğik geçme  
Slant pass



**MICRO-ADSON  
43-268**  
Hassas doku penseti  
Delicate tissue forceps  
12 cm







**COTTLE**  
43-269  
Penset  
Forceps  
14 cm



**LUCAE**  
43-270  
14 cm



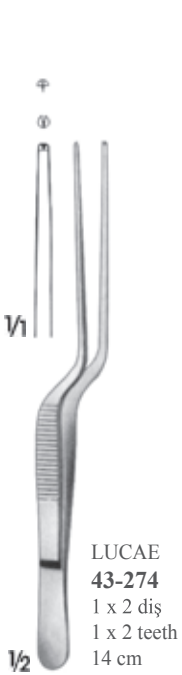
**JANSEN**  
43-271  
16 cm



**ADSON**  
43-272  
17.5 cm



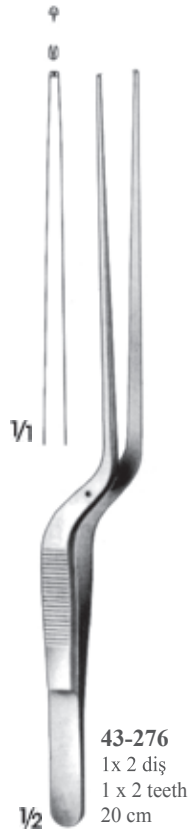
**GRUENWALD**  
43-273  
20 cm



**LUCAE**  
43-274  
1 x 2 diş  
1 x 2 teeth  
14 cm



**43-275**  
1 x 2 diş  
1 x 2 teeth  
16 cm



**43-276**  
1 x 2 diş  
1 x 2 teeth  
20 cm



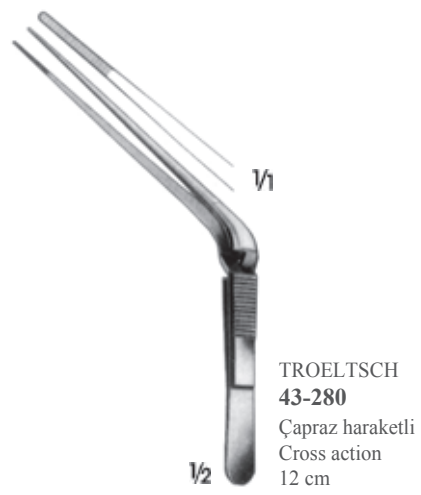
**43-277**  
18.5 cm



**43-278**  
16 cm



WILDE  
43-279  
11.5 cm



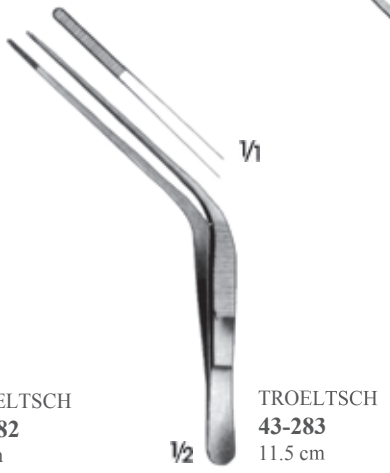
TROELTSCH  
43-280  
Çapraz hareketli  
Cross action  
12 cm



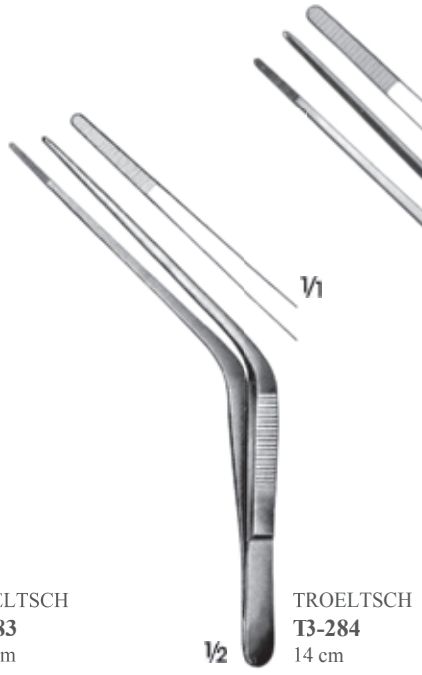
TROELTSCH  
43-281  
1 x 2 diş  
1 x 2 teeth  
11.5 cm



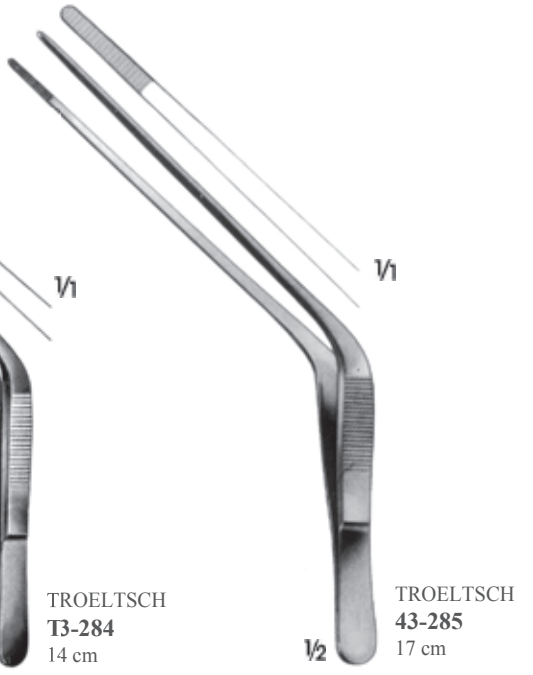
TROELTSCH  
43-282  
10 cm



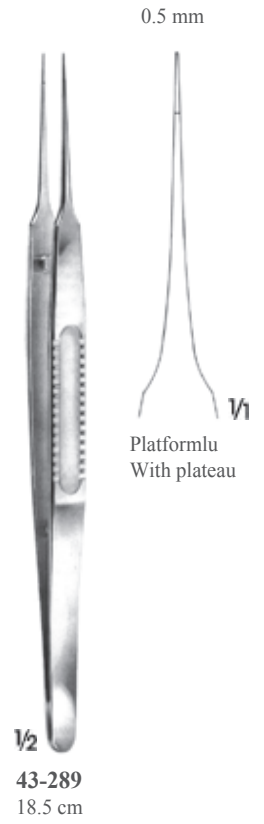
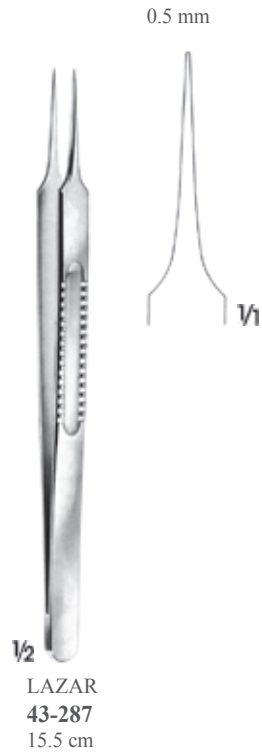
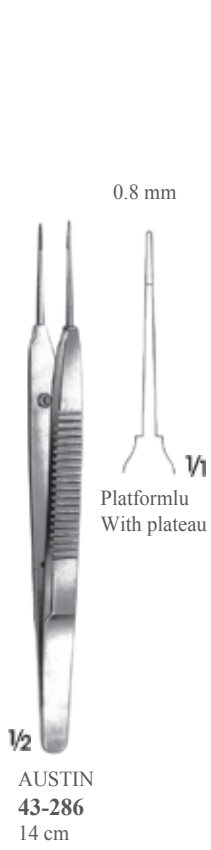
TROELTSCH  
43-283  
11.5 cm

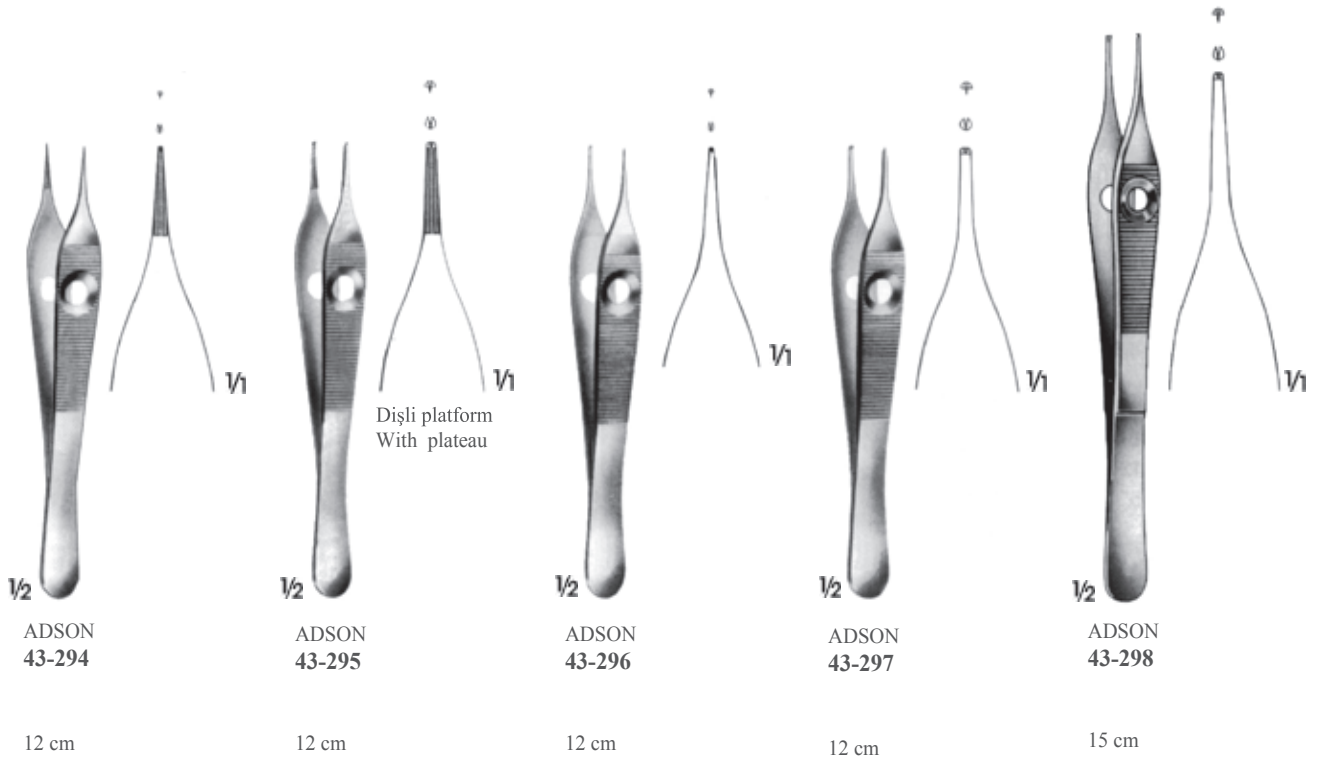


TROELTSCH  
13-284  
14 cm



TROELTSCH  
43-285  
17 cm





ADSON  
43-294

12 cm

ADSON  
43-295

12 cm

ADSON  
43-296

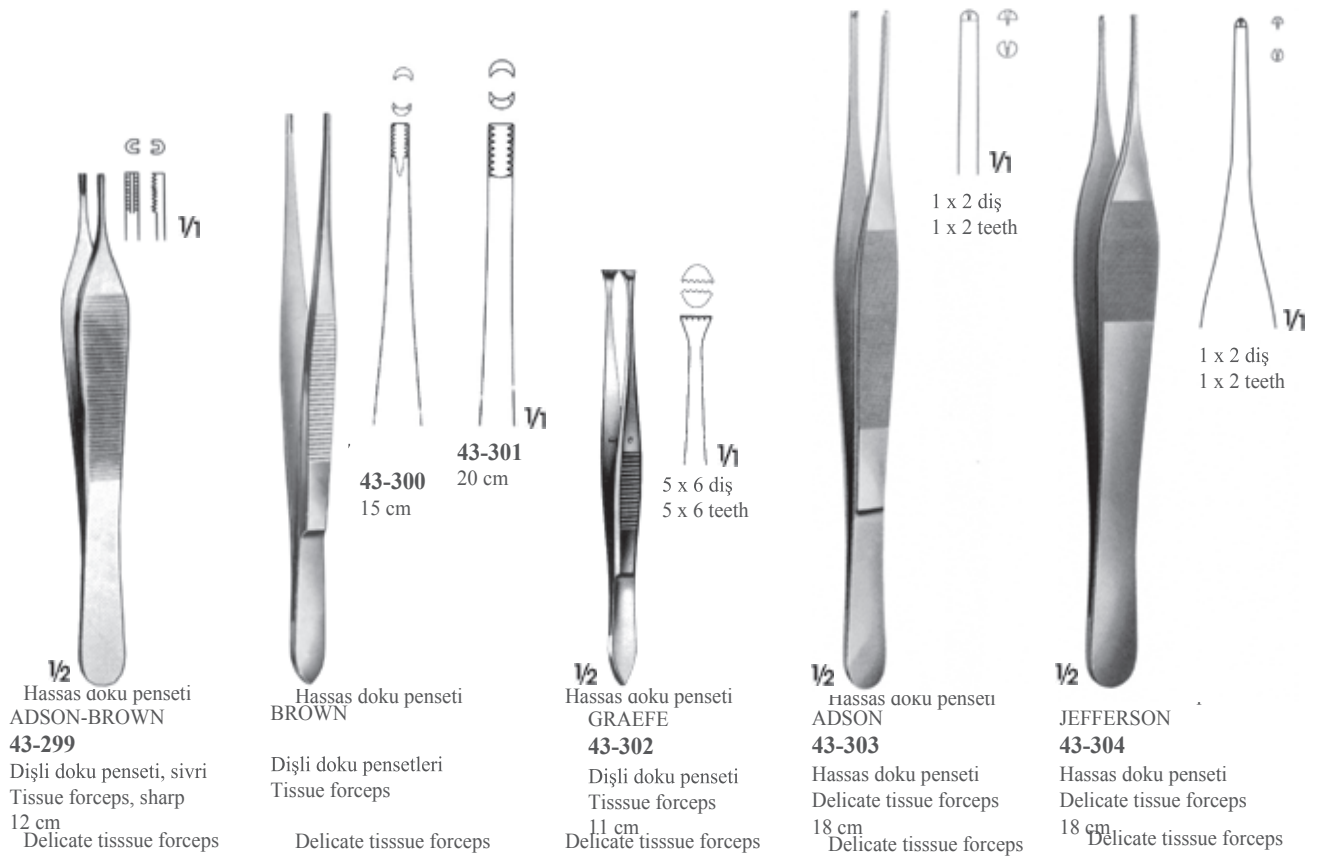
12 cm

ADSON  
43-297

12 cm

ADSON  
43-298

15 cm



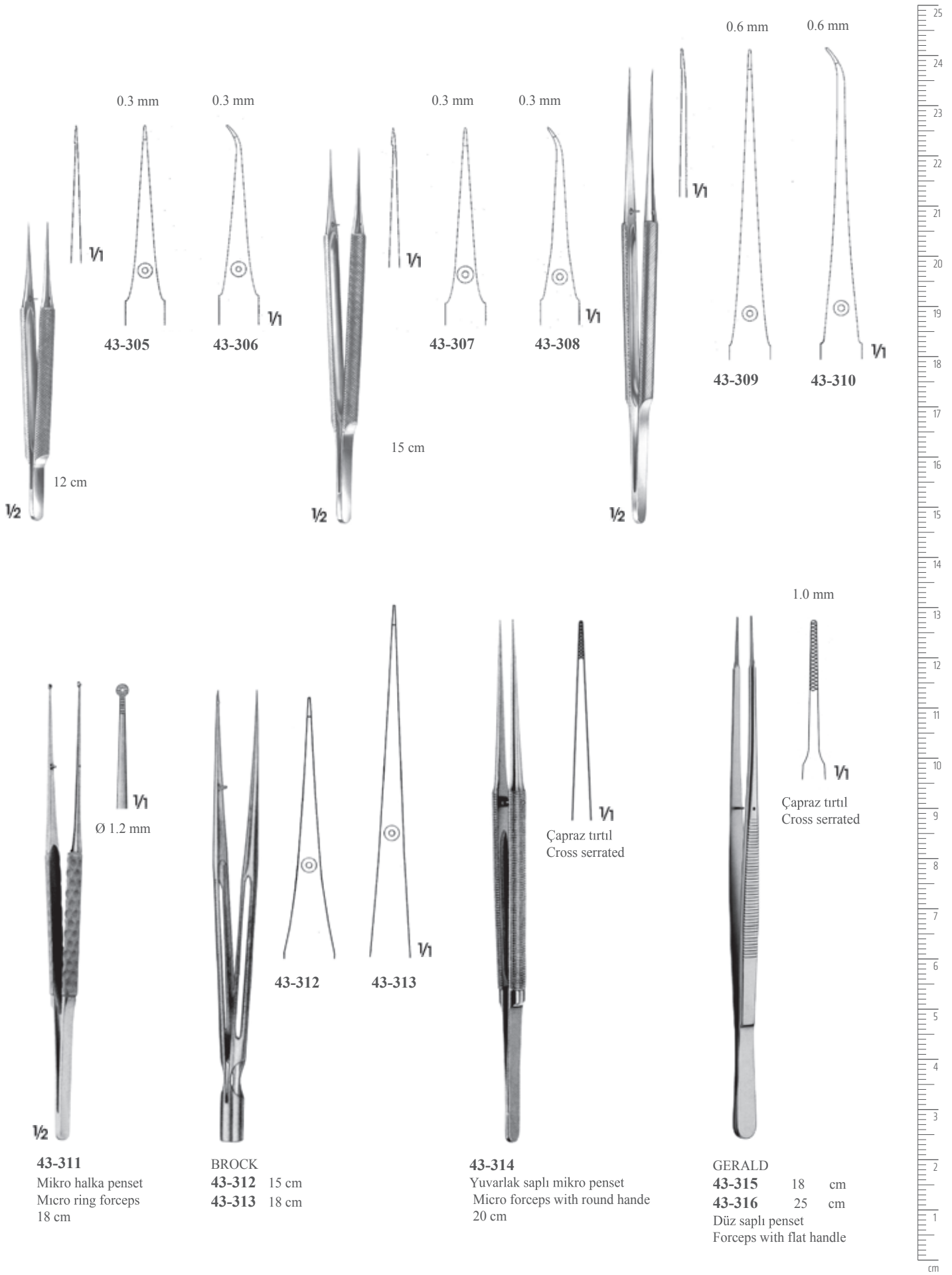
Hassas doku penseti  
ADSON-BROWN  
43-299  
Dişli doku penseti, sivri  
Tissue forceps, sharp  
12 cm  
Delicate tissue forceps

Hassas doku penseti  
BROWN  
43-300  
Dişli doku pensetleri  
Tissue forceps  
15 cm  
Delicate tissue forceps

Hassas doku penseti  
GRAEFE  
43-302  
Dişli doku penseti  
Tissue forceps  
11 cm  
Delicate tissue forceps

Hassas doku penseti  
ADSON  
43-303  
Hassas doku penseti  
Delicate tissue forceps  
18 cm  
Delicate tissue forceps

Hassas doku penseti  
JEFFERSON  
43-304  
Hassas doku penseti  
Delicate tissue forceps  
18 cm  
Delicate tissue forceps

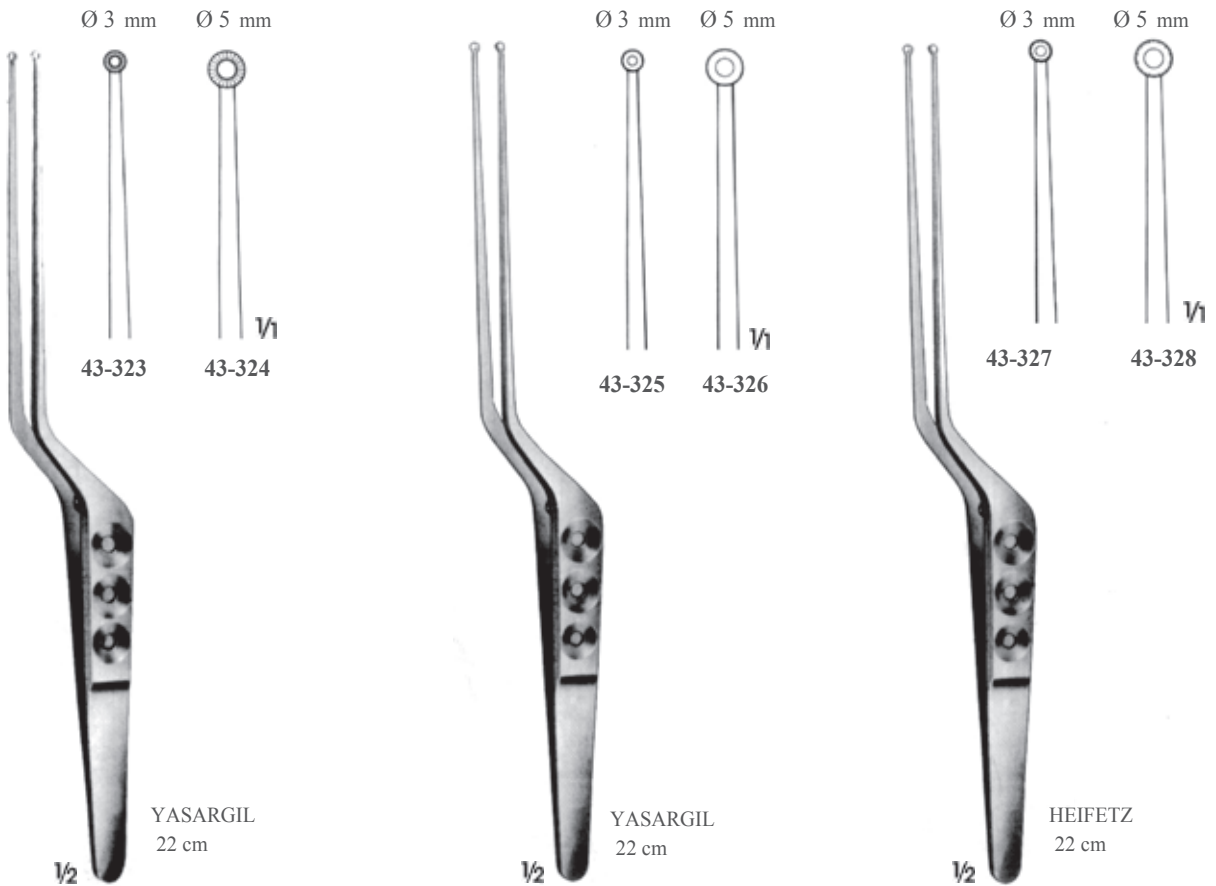
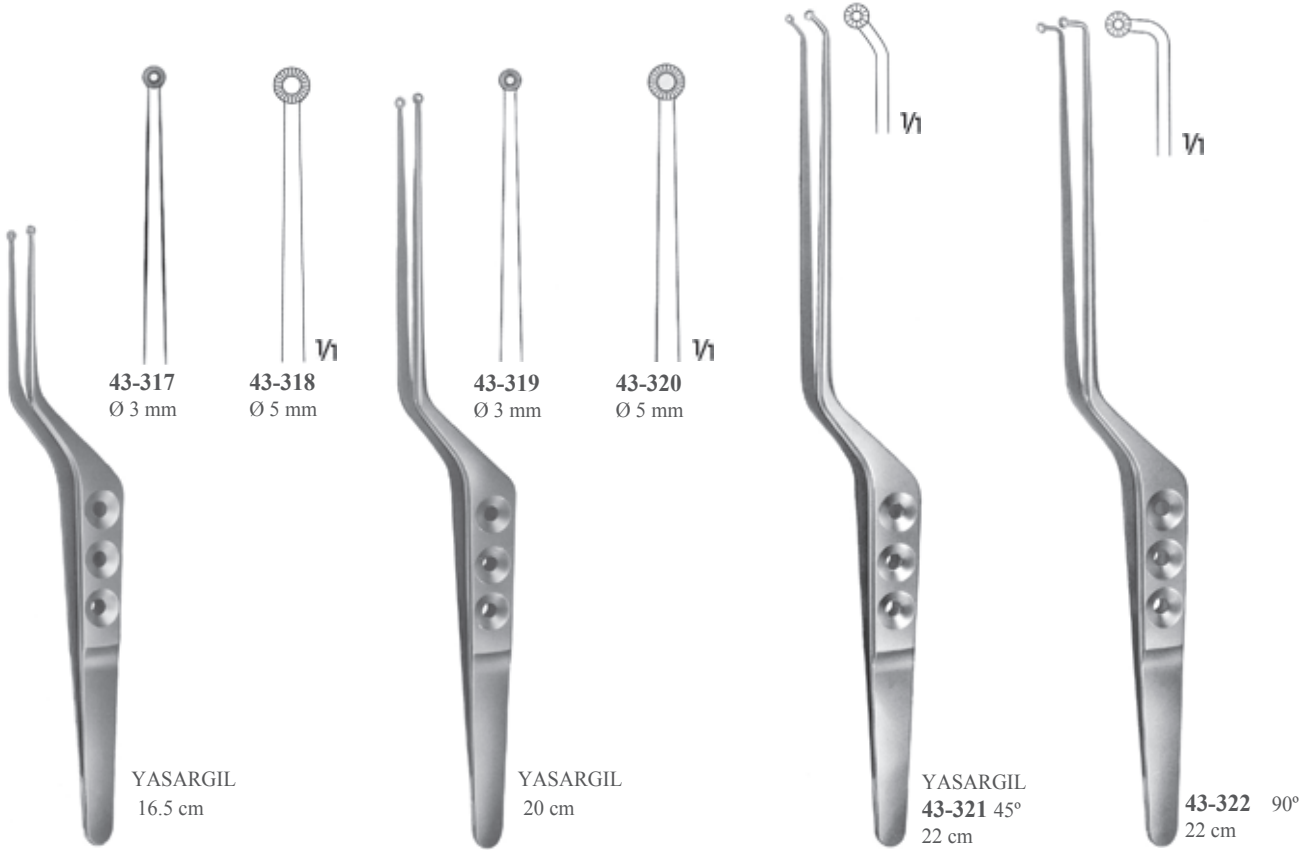


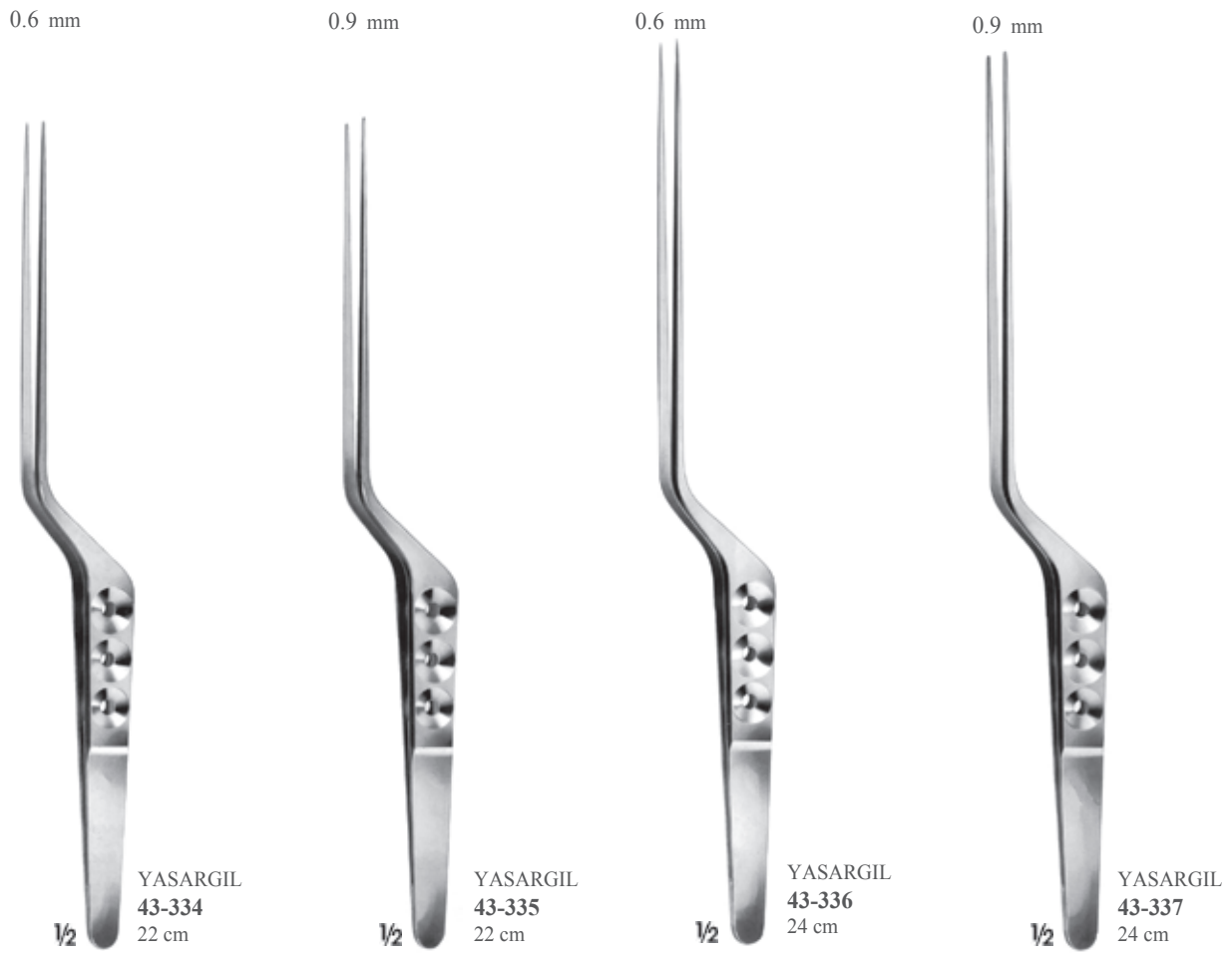
**43-311**  
Mikro halka penset  
Micro ring forceps  
18 cm

**BROCK**  
**43-312** 15 cm  
**43-313** 18 cm

**43-314**  
Yuvarlak saplı mikro penset  
Micro forceps with round handle  
20 cm

**GERALD**  
**43-315** 18 cm  
**43-316** 25 cm  
Düz saplı penset  
Forceps with flat handle









43-338  
17.5 cm

43-339  
21.5 cm

CAIRNS-DOTT



43-340  
20 cm



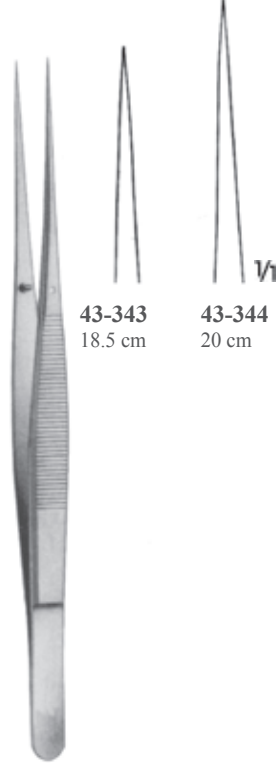
43-341  
15 cm

MC INDOE



43-342  
20 cm

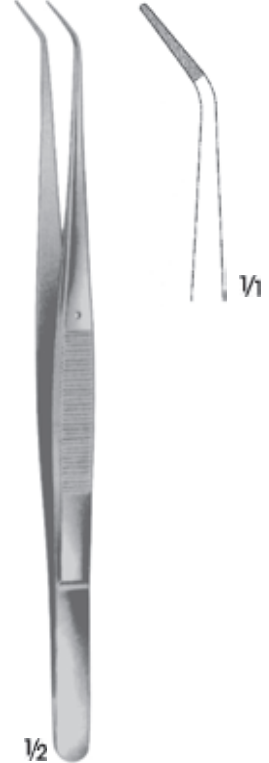
COOLEY



43-343  
18.5 cm

43-344  
20 cm

Düz Ağız/Smooth jaws

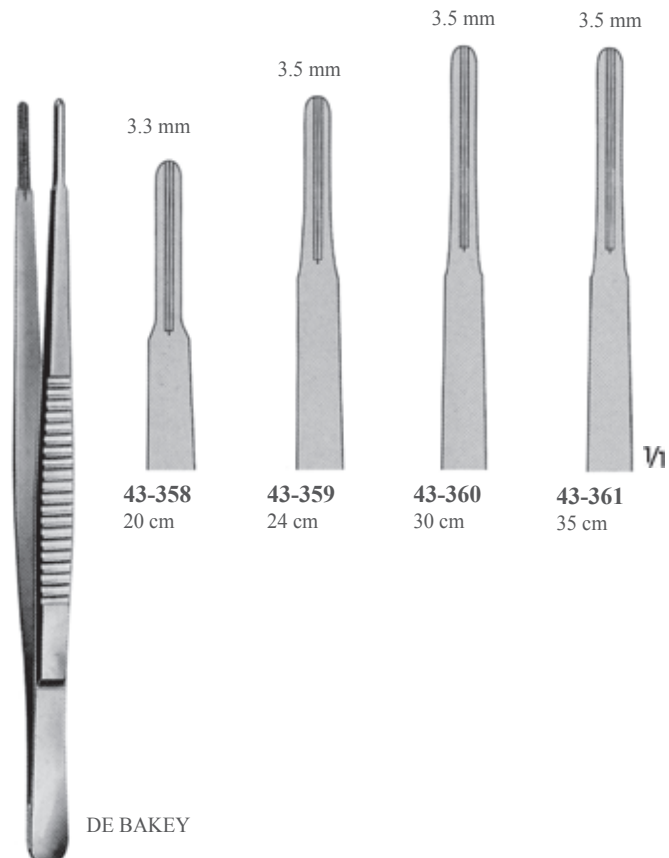
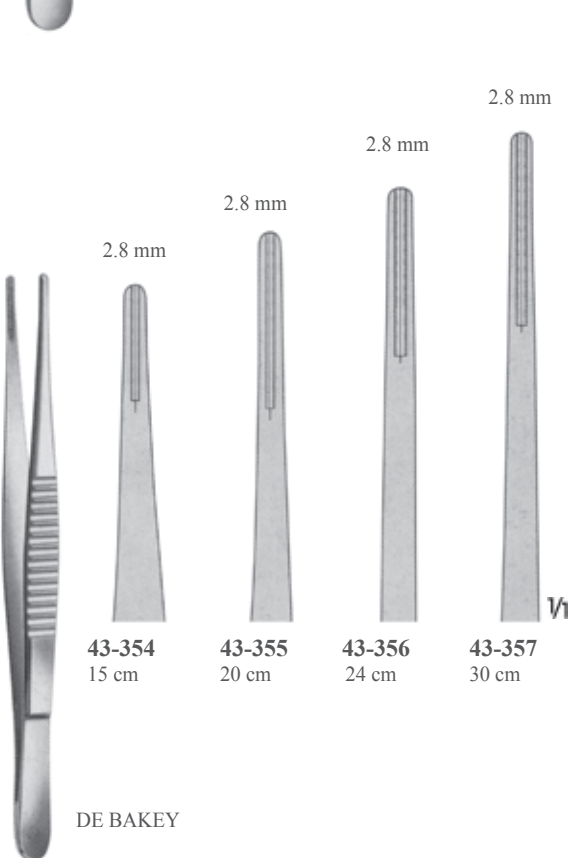
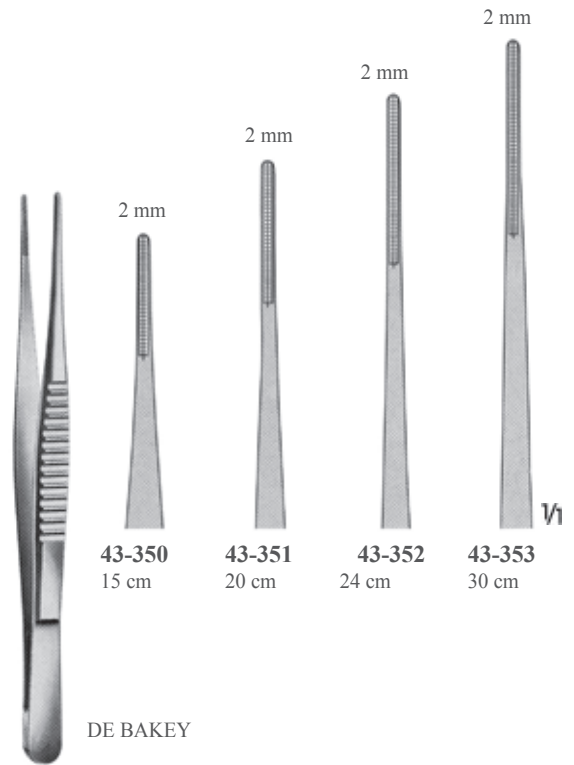
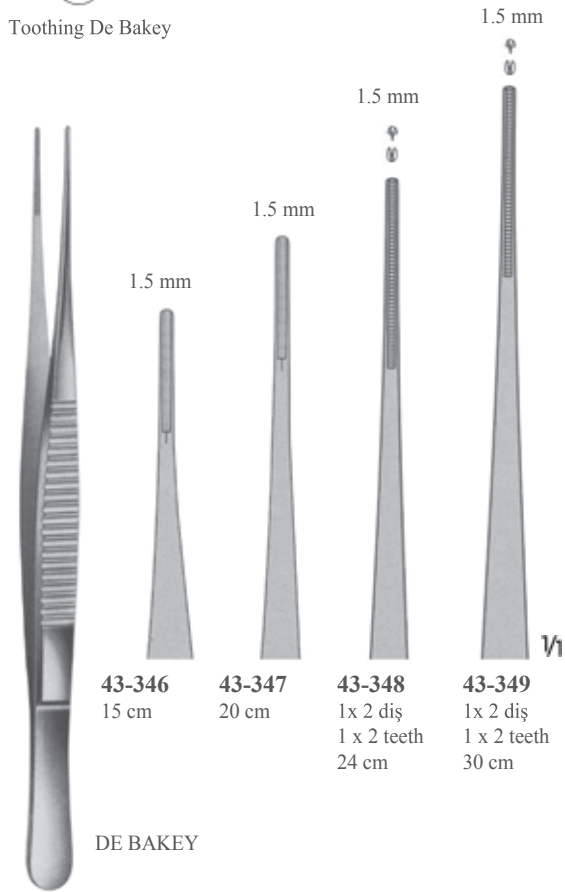


43-345  
20 cm

De Bakey Diş



Toothing De Bakey





GERALD



43-362  
17.5 cm



43-363  
17.5 cm



43-364  
23 cm



CUSHING



43-365  
18 cm



43-366  
20 cm



43-367  
25 cm



43-368  
20 cm



BROPHY

1/2

20 cm



43-369



43-370



GILLIES  
43-371  
15 cm

1/2



1/2



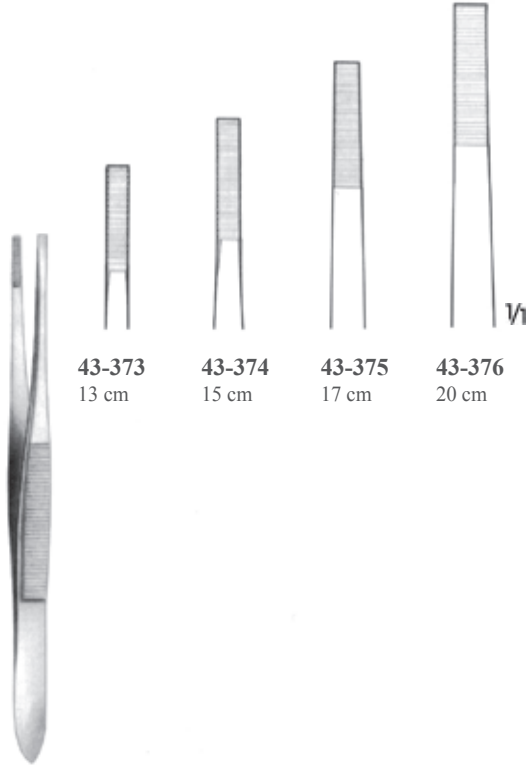
43-372  
15.5 cm

1/2

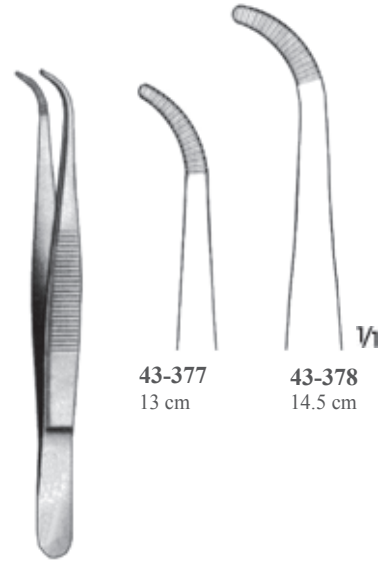


1/2





SCHWEDISCHES MODELL  
Diseksiyon pensetleri  
Dissecting forceps



Orta/Medium  
Diseksiyon pensetleri  
Dissecting forceps



OCHSNER  
43-379  
Ligatür penseti  
Ligature forceps  
14.5 cm



BONNEY  
43-380  
Diseksiyon penseti  
Dissecting forceps  
17.5 cm



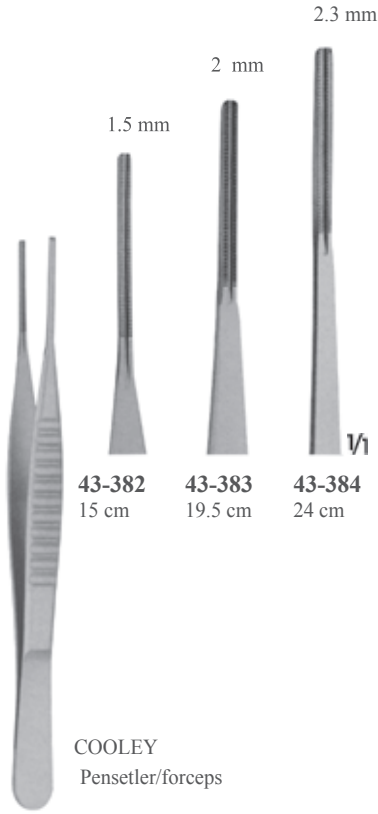
RAMSEY  
43-381  
Diseksiyon penseti  
Dissecting forceps  
18 cm



De Bakey Diş



Toothing De Bakey



**43-382**  
15 cm

**43-383**  
19.5 cm

**43-384**  
24 cm

COOLEY  
Pensetler/forceps



DE BAKEY **43-385**  
18.5 cm  
**43-386 21 cm**  
uvarlak Saplı  
Mikro pensetler  
Micro forceps With  
round handle



DE BAKEY **43-387**  
18.5 cm  
**43-388 21 cm**  
Yuvarlak saplı  
Mikro pensetler  
Micro forceps With  
round handle



DE BAKEY  
**43-389** 18 cm  
**43-390** 20 cm  
Düz saplı  
Mikro penset  
Micro forceps  
With round handle



DE BAKEY  
**43-391** 15 cm  
**43-392** 19.5 cm  
**43-393** 24 cm  
Penset/forceps



**43-394**  
15 cm

**43-395**  
20 cm

**43-396**  
24 cm

**43-397**  
30 cm

Ultra hafif pensetler  
Ultra-Light forceps



**43-398**  
12.5 cm

**TREVES**  
Doku pensetleri  
Tissue forceps



**43-399**  
15 cm



**43-400**  
14.5 cm

Doku pensetleri  
Tissue forceps



**43-401**  
16 cm



**43-402**  
17.5 cm

**GERALD**  
Hassas doku pensetleri  
Delicate tissue forceps



**43-403**  
23 cm



**43-404**  
17.5 cm



**43-405**  
Doku penset  
Tissue forceps  
20 cm



**BROPHY**  
**43-406**  
Doku penset  
Tissue forceps  
20 cm



**CUSHING**  
**43-407**  
Doku penset  
Tissue forceps  
18 cm



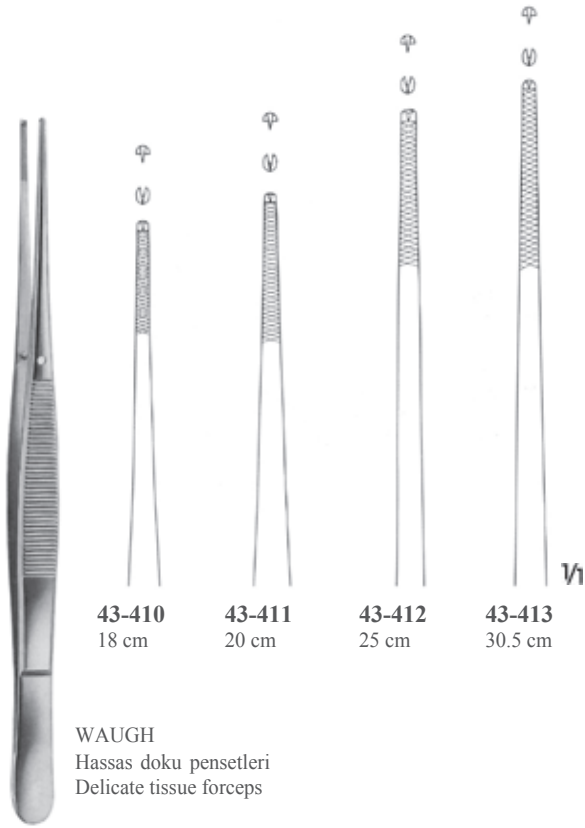
**STRASSBURGER MODEL**  
**43-408 - 43-409**  
Doku pensetleri  
Tissue forceps



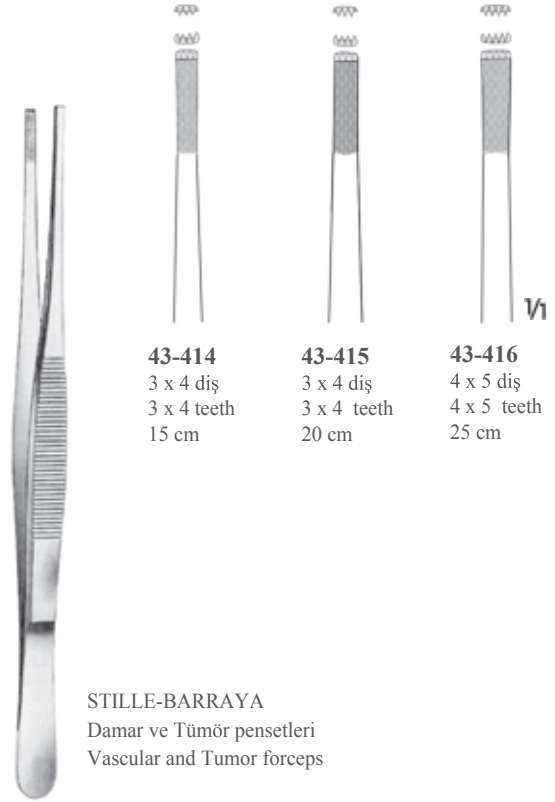
**43-408**  
15 cm



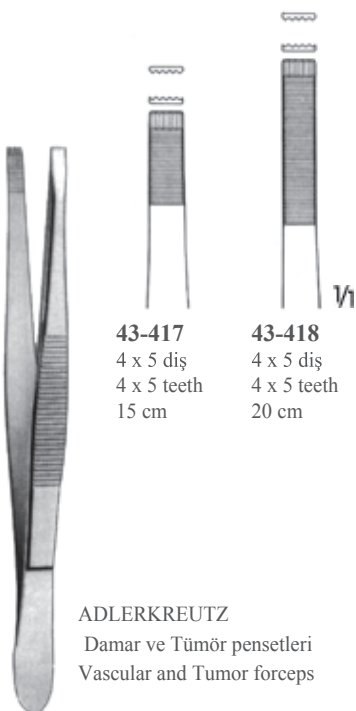
**43-409**  
20 cm



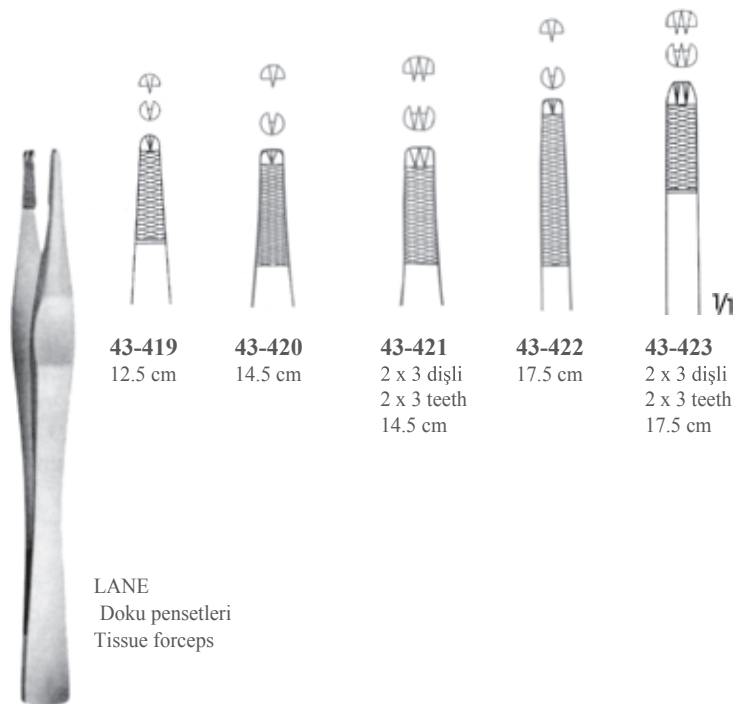
**WAUGH**  
Hassas doku pensetleri  
Delicate tissue forceps



**STILLE-BARRAYA**  
Damar ve Tümör pensetleri  
Vascular and Tumor forceps



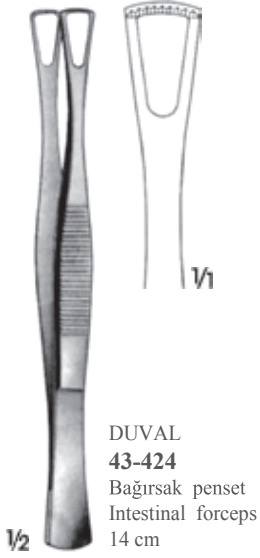
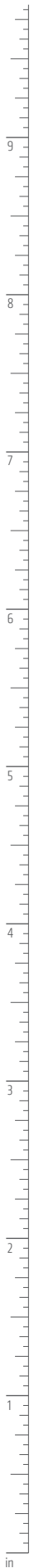
**ADLERKREUTZ**  
Damar ve Tümör pensetleri  
Vascular and Tumor forceps



**LANE**  
Doku pensetleri  
Tissue forceps



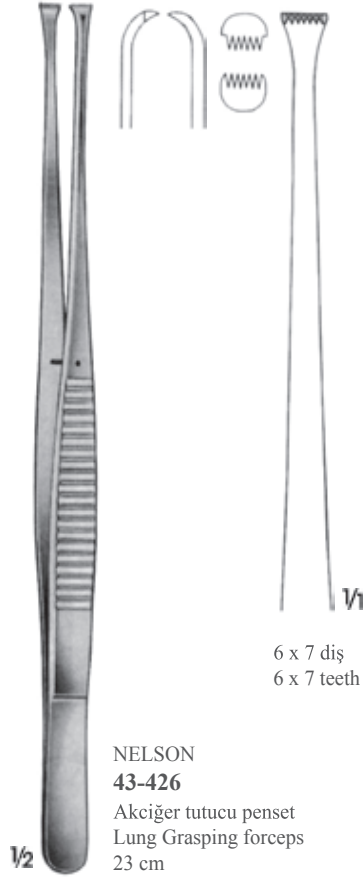




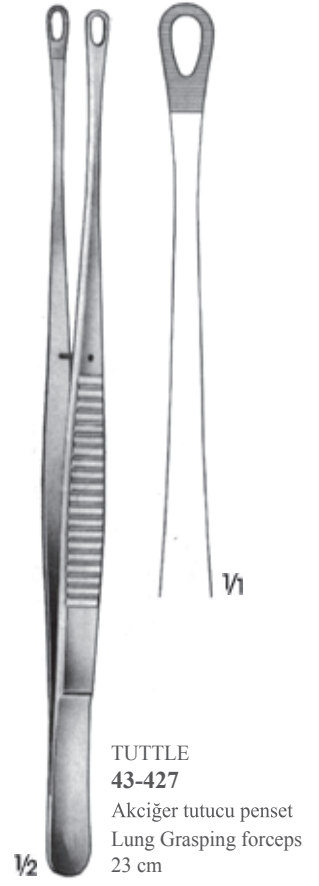
**DUVAL**  
**43-424**  
Bağırsak penset  
Intestinal forceps  
14 cm



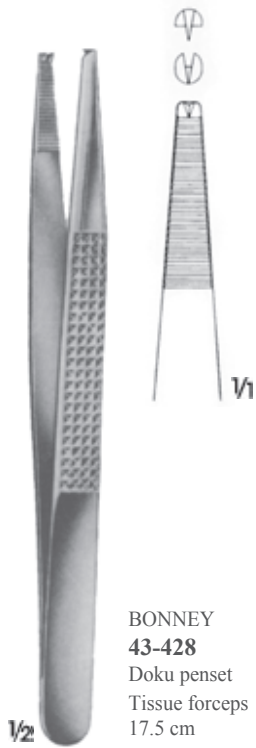
**DENNIS-BROWNE**  
**43-425**  
Bağırsak pensetleri  
Intestinal forceps  
19 cm



**NELSON**  
**43-426**  
Akciğer tutucu penset  
Lung Grasping forceps  
23 cm



**TUTTLE**  
**43-427**  
Akciğer tutucu penset  
Lung Grasping forceps  
23 cm



**BONNEY**  
**43-428**  
Doku penset  
Tissue forceps  
17.5 cm



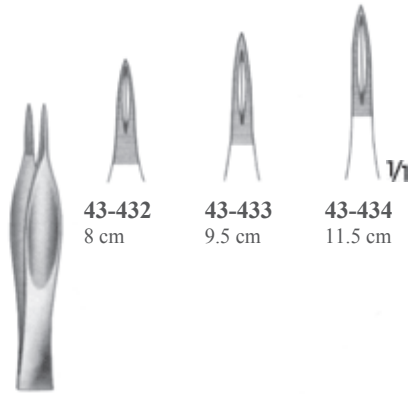
**CHARNLEY**  
**43-429**  
Doku penset  
Tissue forceps  
18 cm



**JACKSON-BURROWS**  
**43-430**  
Doku penset  
Tissue forceps  
14 cm



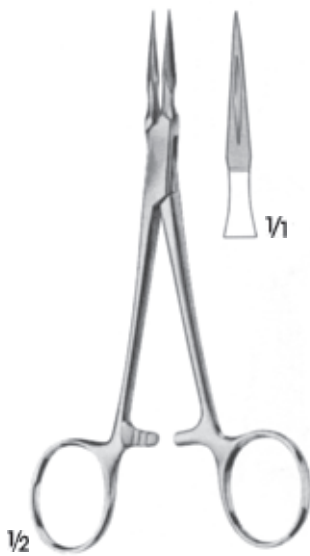
**43-431**  
Kıymık penset  
Splinter forceps  
8 cm



Kıymık pensetler



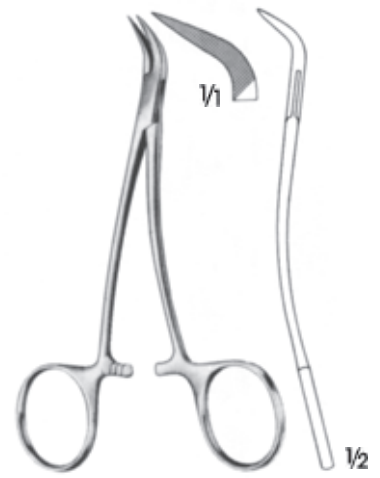
**HUNTER**  
**43-435**  
Kıymık penset  
Splinter forceps  
10.5 cm



**STIEGLITZ**  
**43-436**  
Kıymık penset  
Splinter forceps  
14 cm

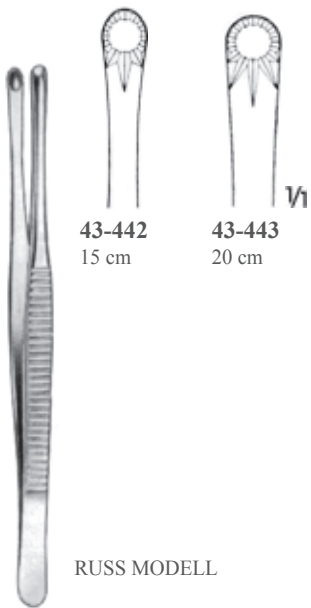
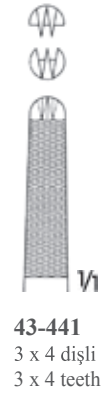
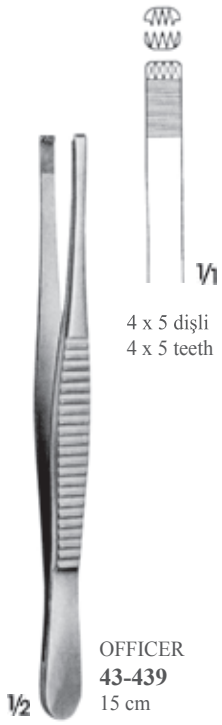


**STIEGLITZ**  
**43-437**  
Kıymık penset  
Splinter forceps  
14 cm



**STIEGLITZ**  
**43-438**  
Kıymık penset  
Splinter forceps  
12 cm







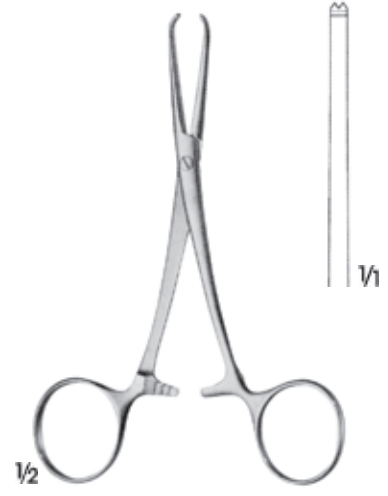
**44-**



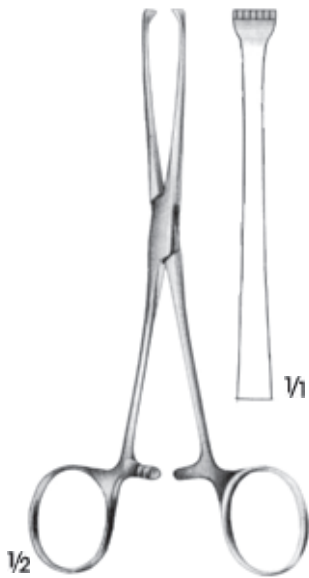
**TUFFIER**  
**44-100**  
5 x 6 diş, sivri  
5 x 6 teeth, sharp  
12.5 cm



**CHAPUT**  
**44-101**  
2 x 3 diş, sivri  
2 x 3 teeth, sharp  
12.5 cm



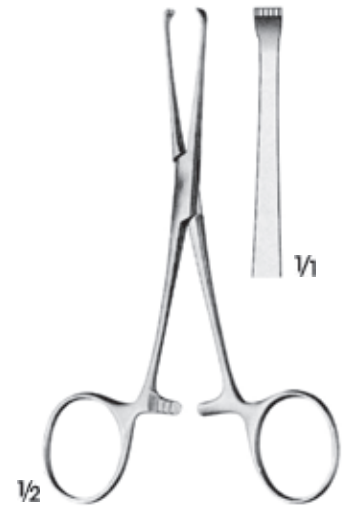
**POIRIER**  
**44-102**  
2 x 3 diş  
2 x 3 teeth  
12.5 cm



**ALLIS**  
**44-103**  
5 x 6 diş/5 x 6 teeth  
15.5 cm

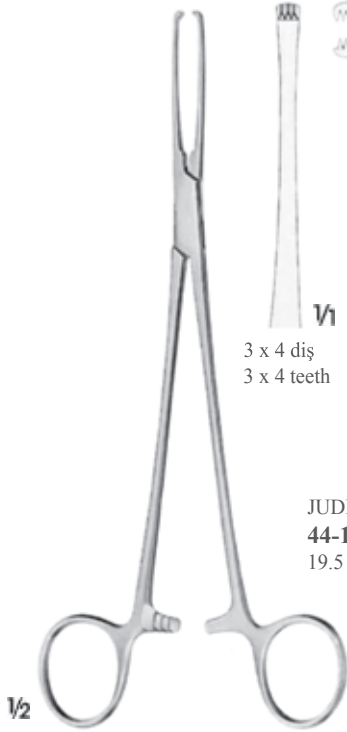


**BOYS-ALLIS**  
**44-104**  
5 x 6 diş/5 x 6 teeth  
15.5 cm



**BABY-ALLIS**  
**44-105**  
4 x 5 diş/4 x 5 teeth  
13 cm

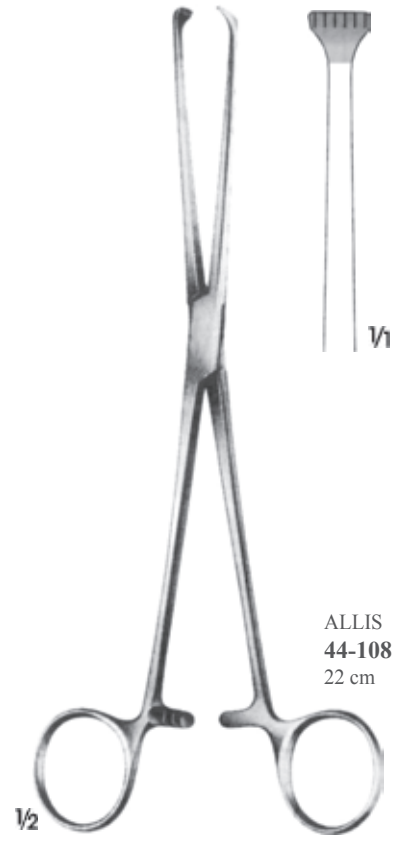




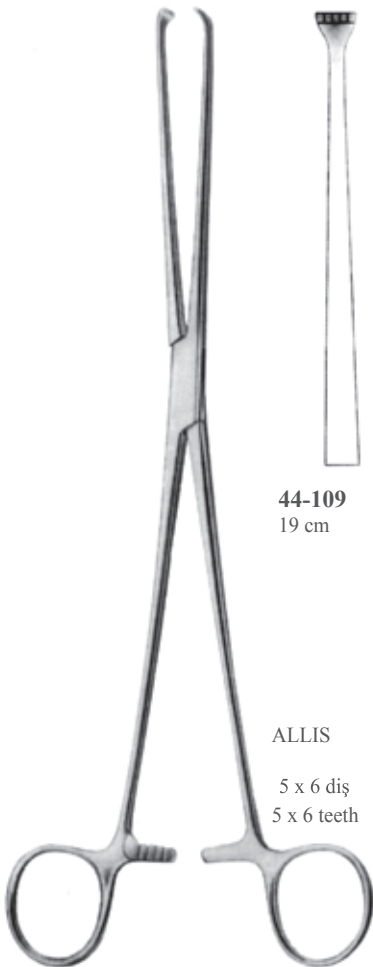
JUDD-ALLIS  
44-106  
19.5 cm



ALLIS-THOMS  
44-107  
20 cm



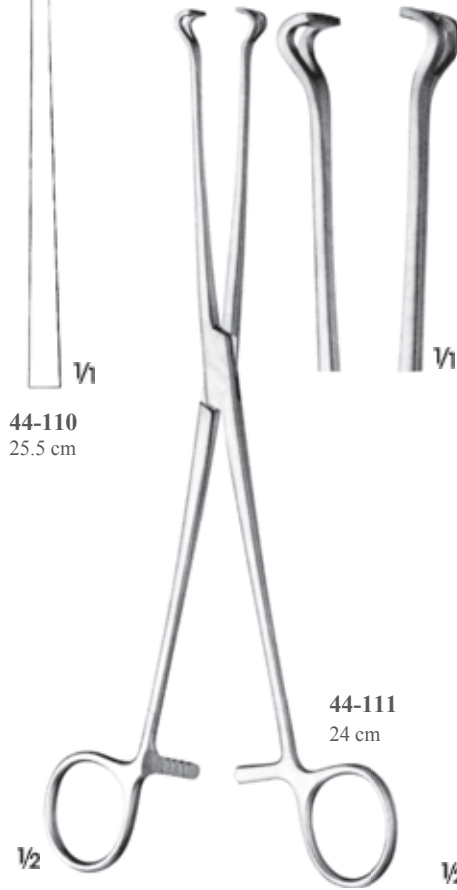
ALLIS  
44-108  
22 cm



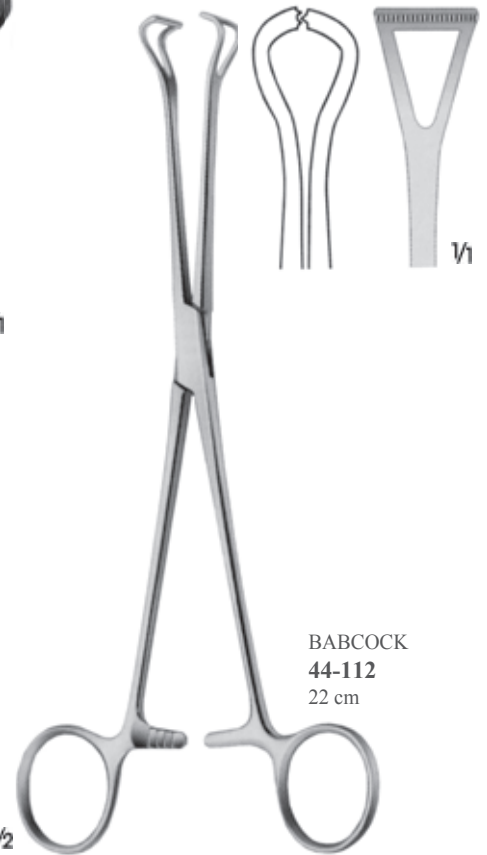
ALLIS  
44-109  
19 cm



44-110  
25.5 cm



44-111  
24 cm



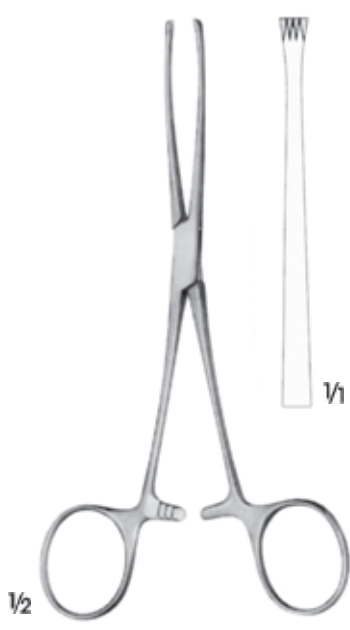
BABCOCK  
44-112  
22 cm







ALLIS-ADAIR  
**44-113**  
9 x 10 diş  
9 x 10 teeth  
16 cm



JUDD-ALLIS  
**44-114**  
3 x 4 diş  
3 x 4 teeth  
15.5 cm



**44-115**  
2 x 3 diş  
2 x 3 teeth



**44-116**  
3 x 4 diş  
3 x 4 teeth



**44-117**  
4 x 5 diş  
4 x 5 teeth

Atromatik  
Atraumatic



ALLIS  
44-118 - 44-124

6.2 mm



**44-118**  
15.5 cm

7.0 mm



**44-119**  
20 cm

8.4 mm



**44-120**  
22 cm

8.4 mm



**44-121**  
25.5 cm

8.4 mm



**44-122**  
30 cm

8.4 mm



**44-123**  
35 cm

5.0 mm



**44-124**  
29.5 cm



LANE



44-125  
13 cm



44-126  
15.5 cm



44-127  
19.5 cm



DOYEN  
44-128  
11 cm



1/1



DOYEN  
44-129  
18 cm



1/1



44-130  
5.5 cm



1/1



ENGL.MOD  
44-131  
8.5 cm



1/1



JONES  
44-132  
8.5 cm



1/1



SCHAEDEL  
44-133  
8.5 cm

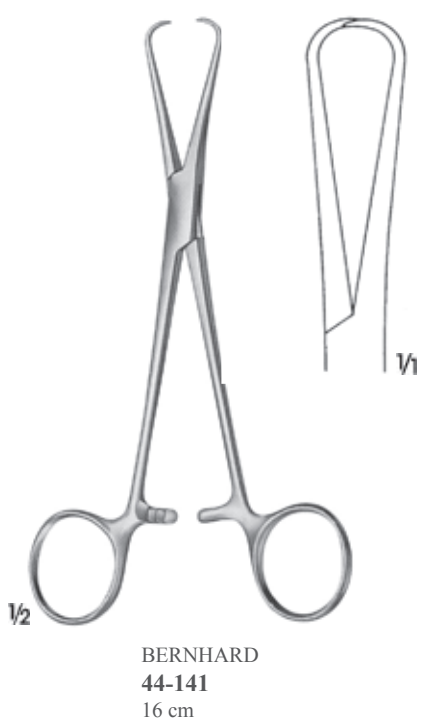
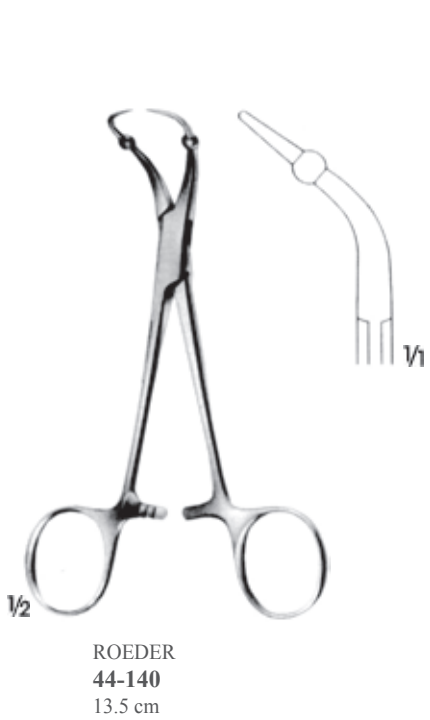
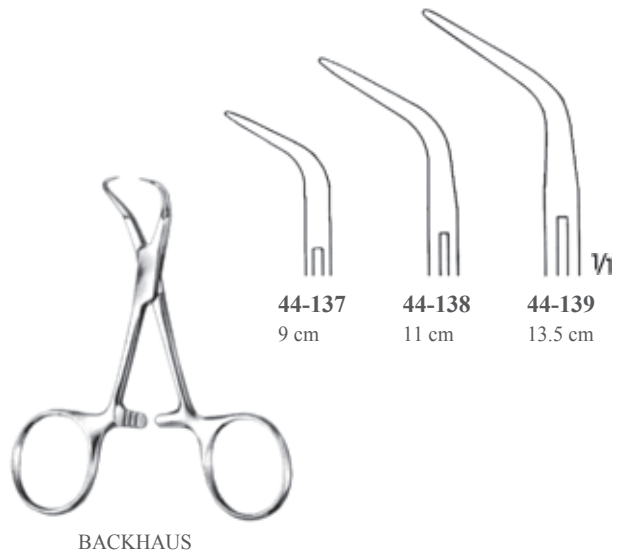


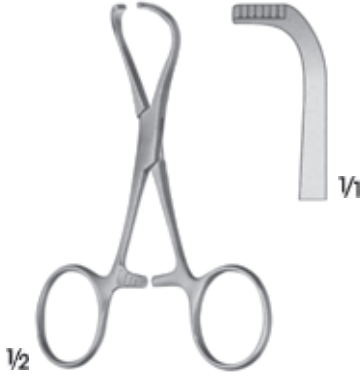
44-133



44-134

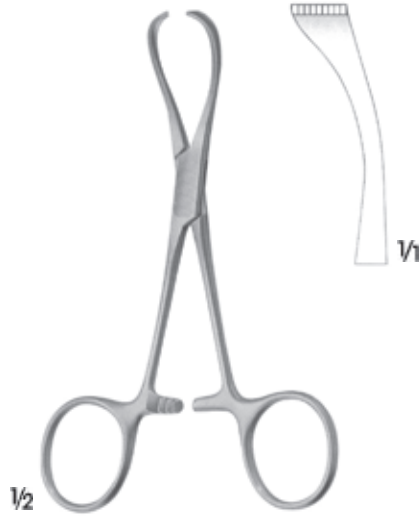






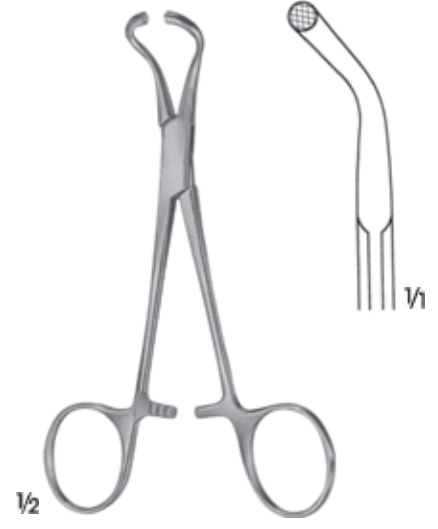
LORNA  
44-143

Non-perforating  
9.5 cm



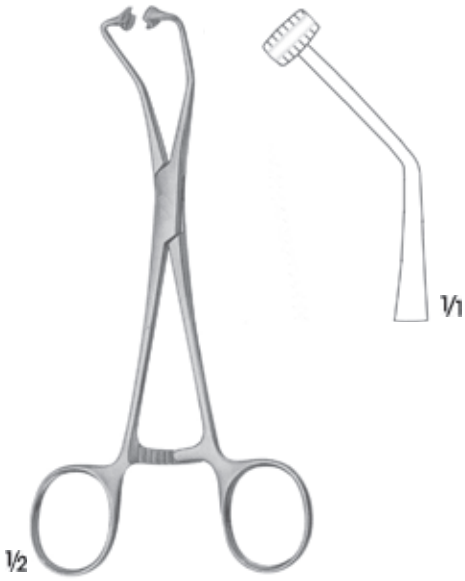
LORNA  
44-144

Non-perforating  
13 cm



44-145

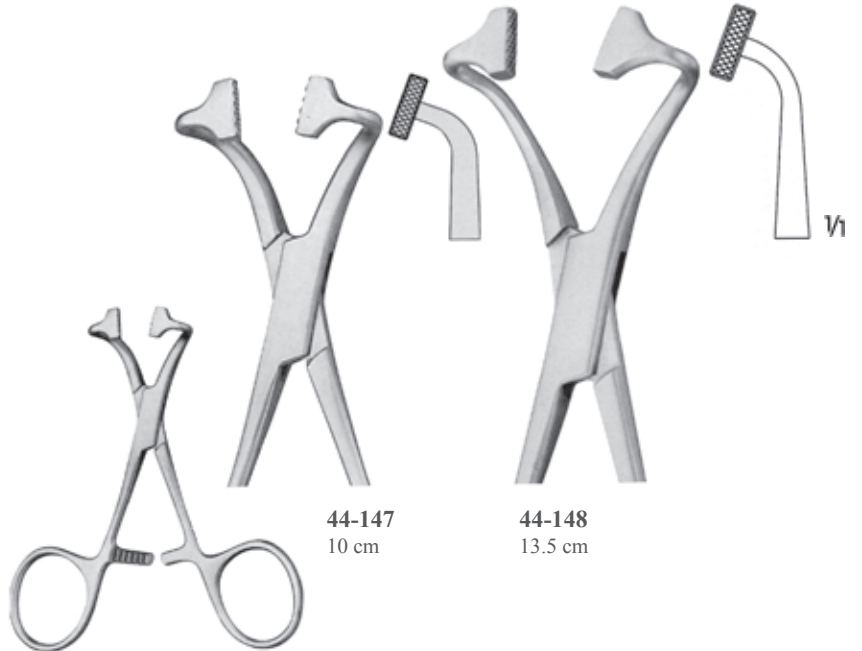
Bez örtüler için  
For towel cloths  
13.5 cm



44-146

Kağıt örtüler için  
For paper cloths  
15 cm

Delmeden tutucu klempe



44-147  
10 cm

44-148  
13.5 cm

44-147 - 44-148

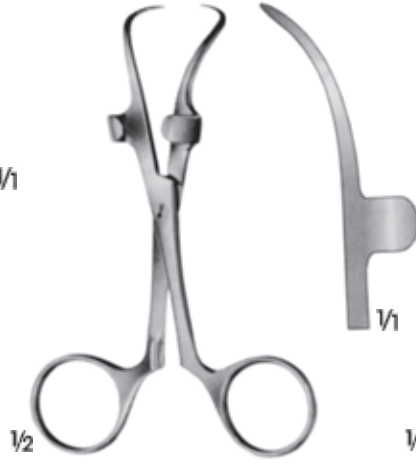
Delmeden tutucu klempe  
Non-perforating

Delmeden tutucu klempe





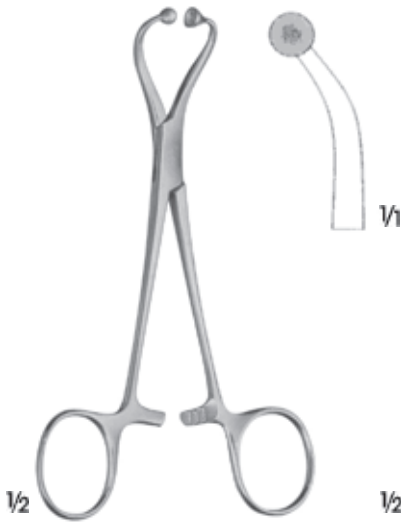
**44-149**  
15 mm kadar tüp tutucu  
With holders for tubing up to 15 mm  
11 cm



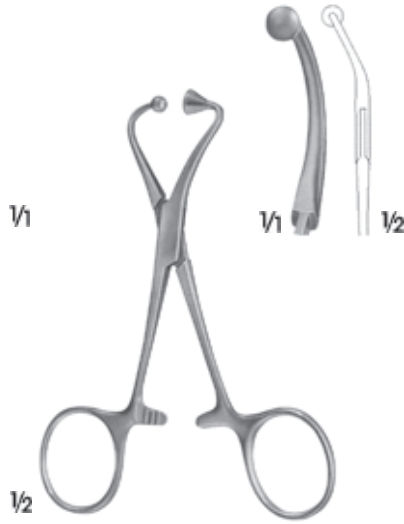
ROBIN  
**44-150**  
13 mm kadar tüp tutucu  
With holders for tubing up to 13 mm  
13.5 cm



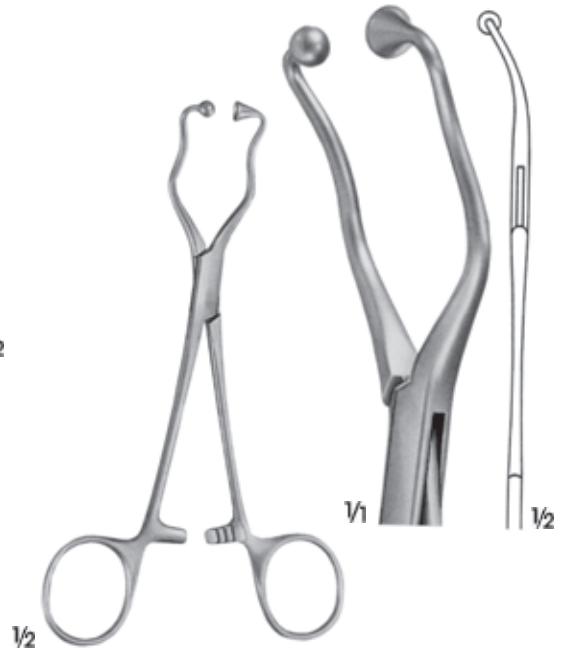
ROBIN  
**44-151**  
5 mm kadar kablo tutucu  
With holders for cable up to 5 mm  
13.5 cm



**44-152**  
Kağıt örtüler için  
For paper cloths  
14 cm



**44-153**  
Kağıt örtüler için  
For paper cloths  
11.5 cm



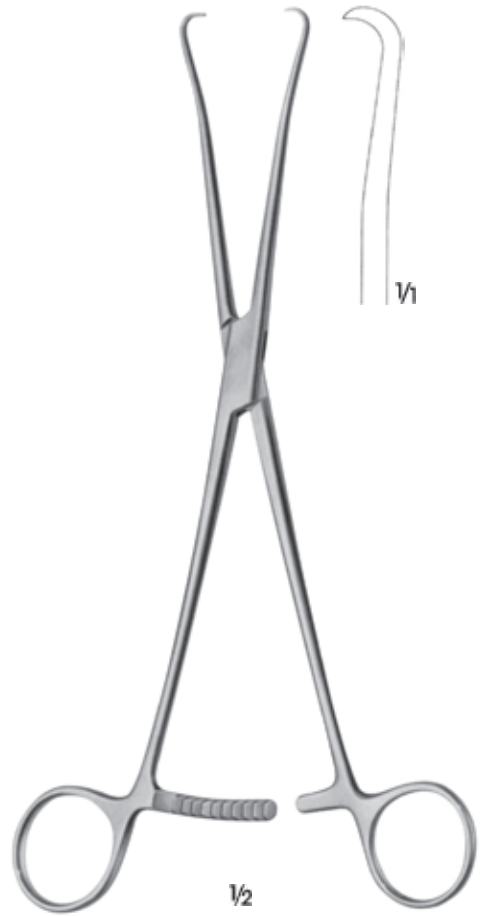
**44-154**  
Tüp sabitleyici pens  
Tube fixation forceps with  
atraumatic jaw parts  
14 cm



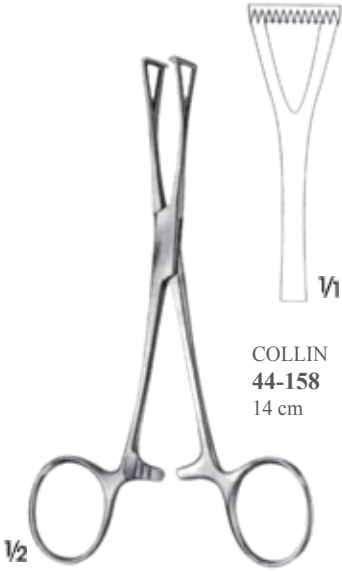
SCHRÖDER  
44-155  
25 cm



POZZI  
44-156  
25.5 cm



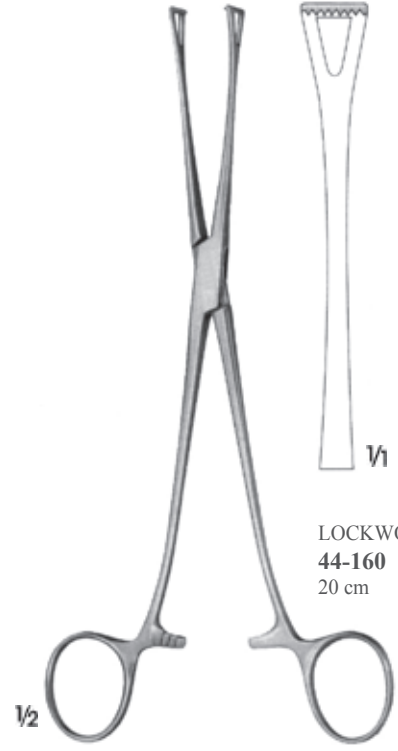
WILSON  
44-157  
24 cm



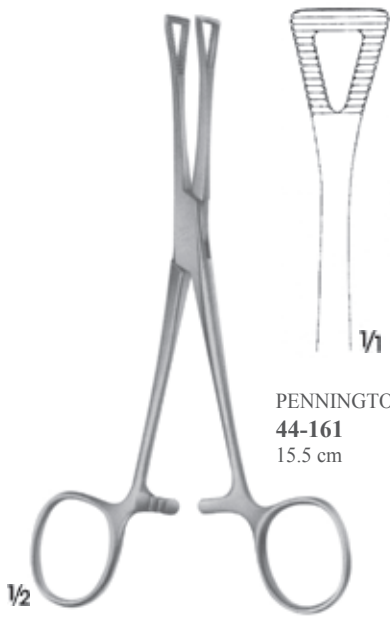
COLLIN  
44-158  
14 cm



COLLIN  
44-159  
18 cm



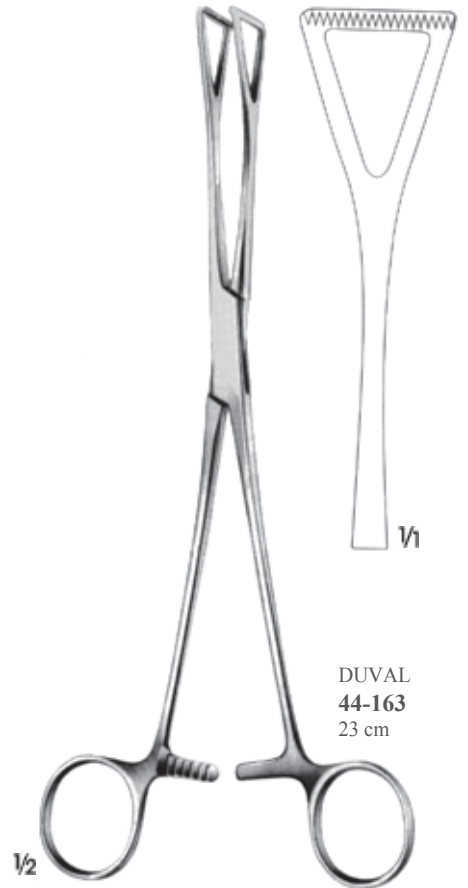
LOCKWOOD  
44-160  
20 cm



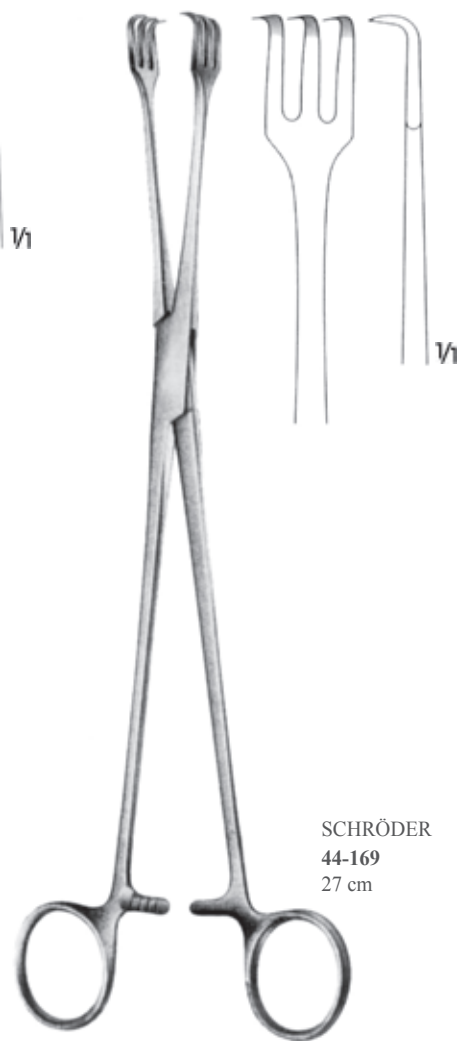
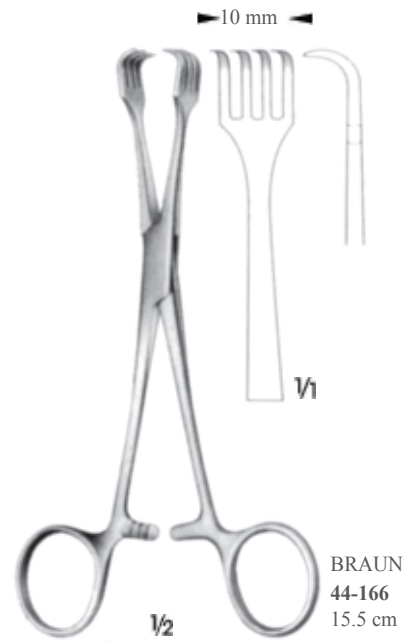
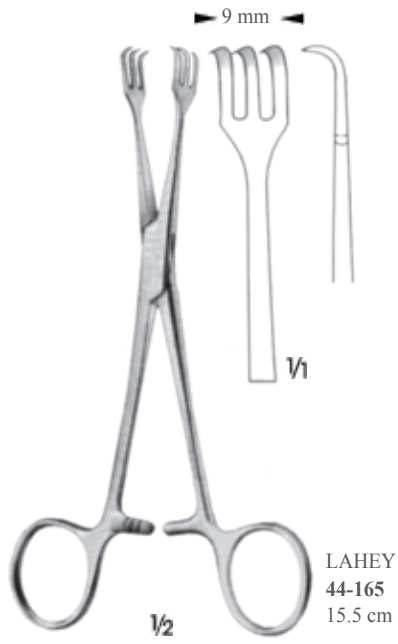
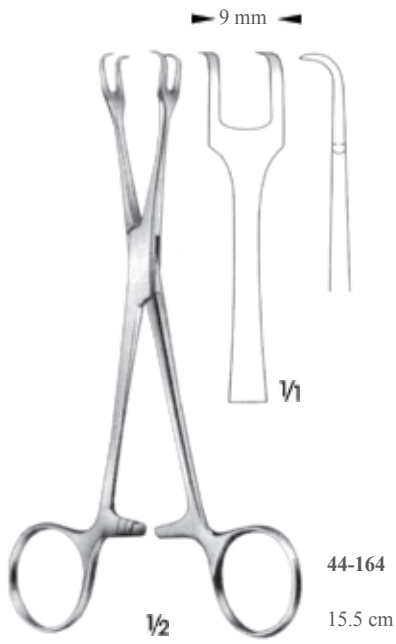
PENNINGTON  
44-161  
15.5 cm



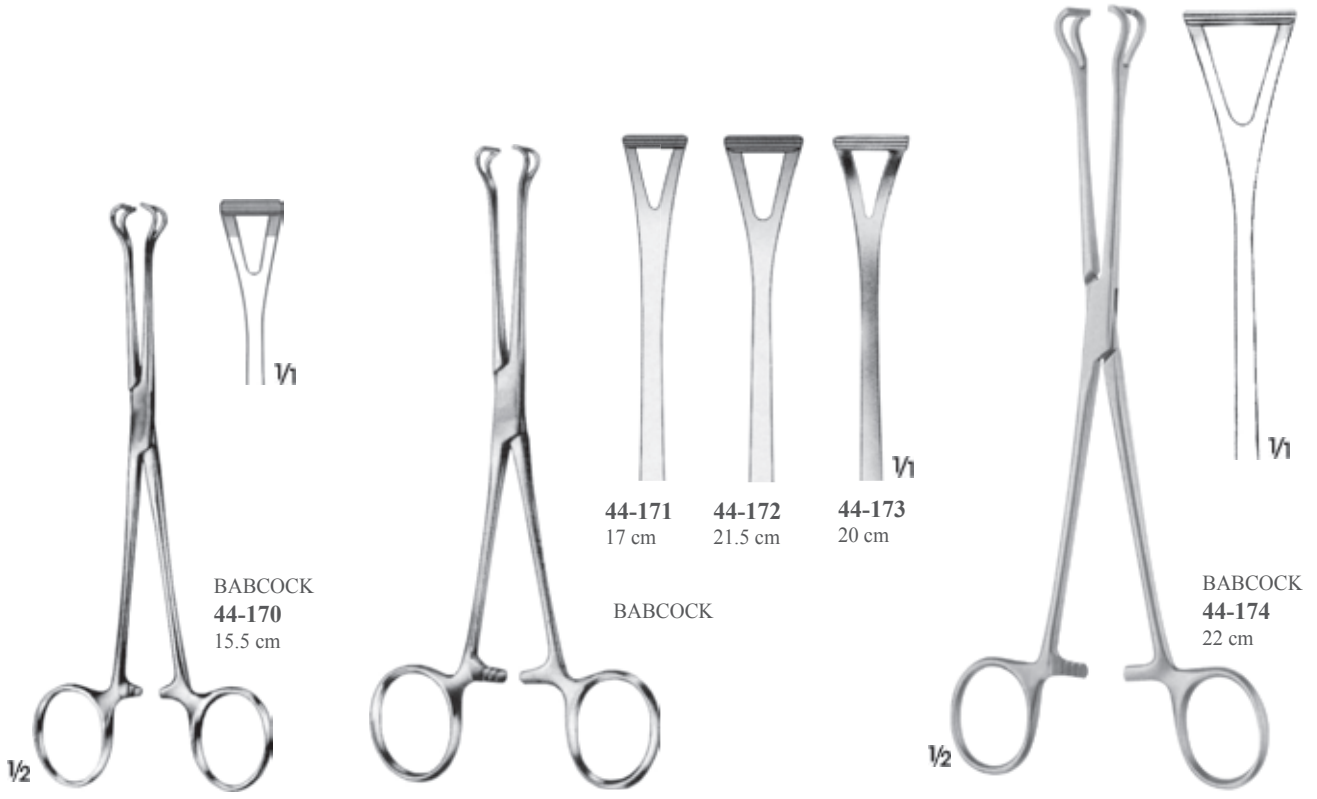
PENNINGTON  
44-162  
20 cm



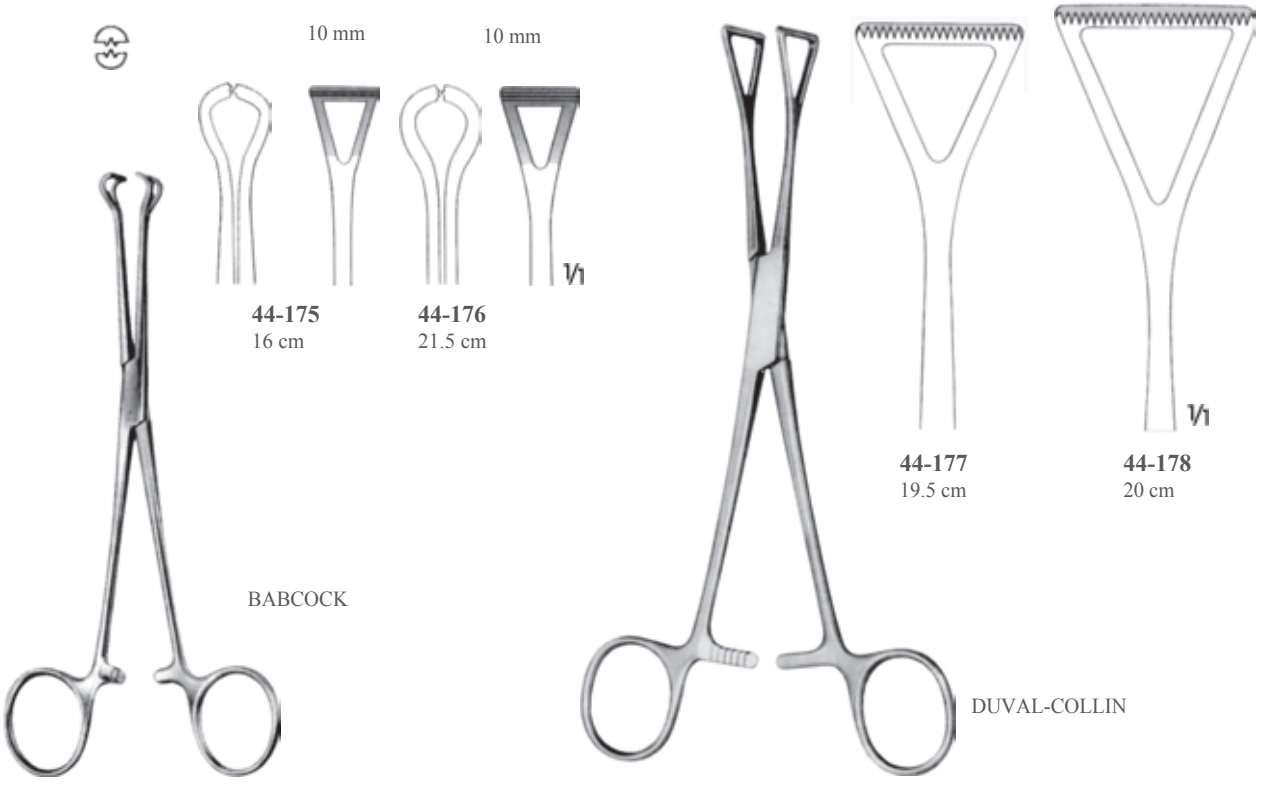
DUVAL  
44-163  
23 cm





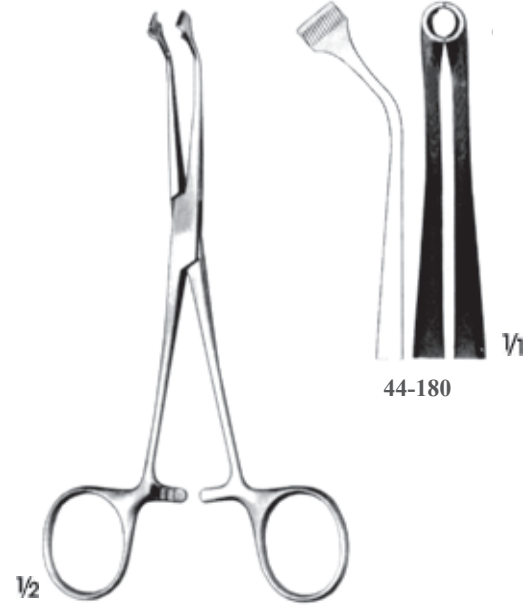


Atromatik  
 Atraumatic

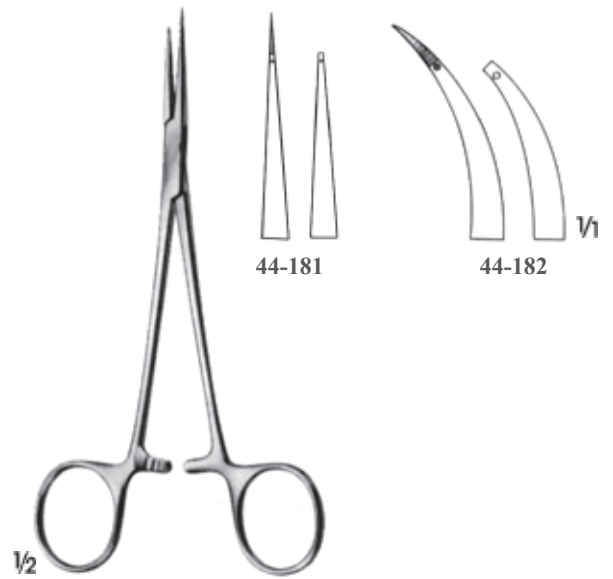




JACKSON  
44-179  
Tendon tutucu pens  
Tendon seizing forceps  
4x5 diş/4x5 teeth  
15 cm

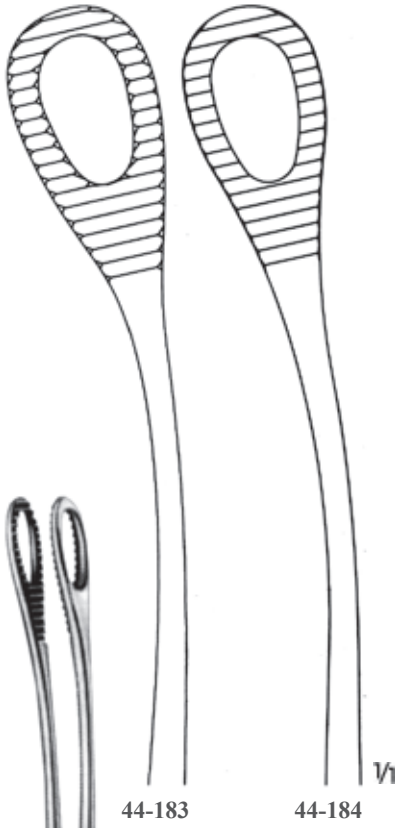


HERZ  
Tendon tutucu pens  
Tendon seizing forceps  
15.5 cm



44-181 - 44-182  
Tendon geçmeli pensleri  
Tendon interlacing forceps  
15 cm

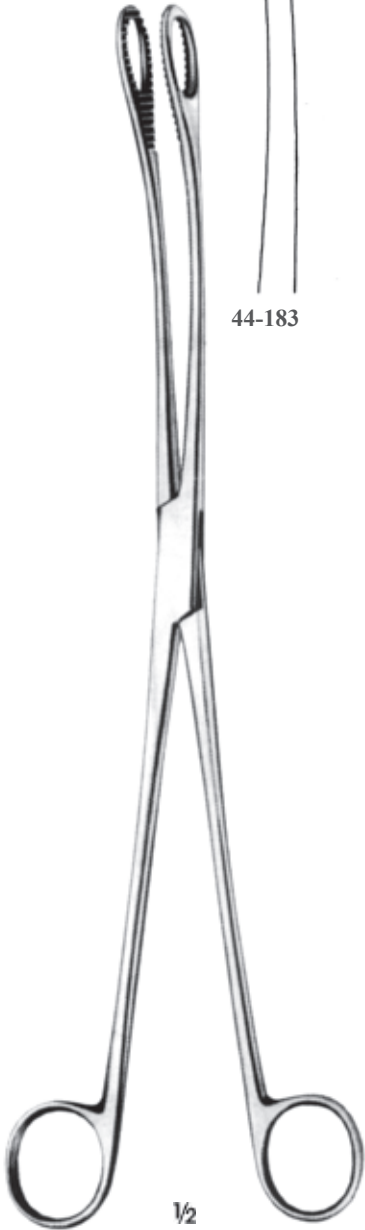




44-183

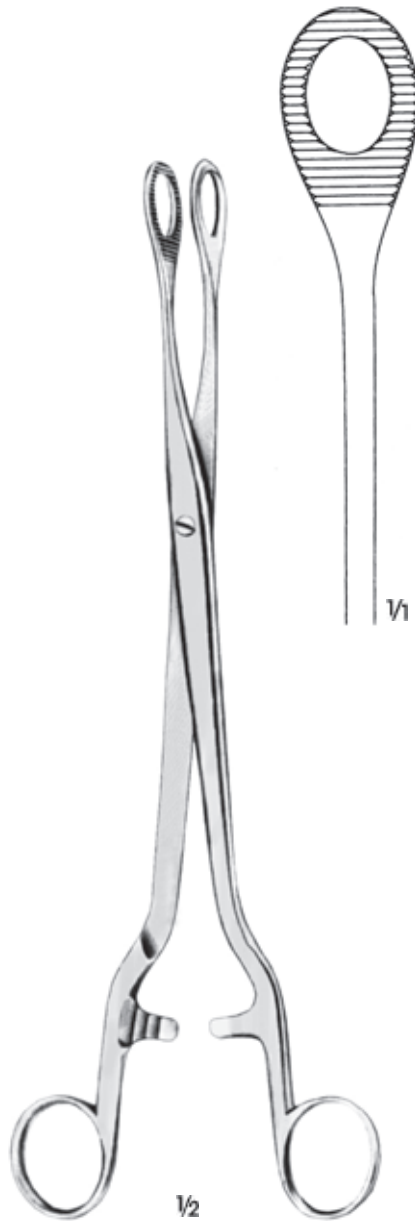
44-184

1/1



1/2

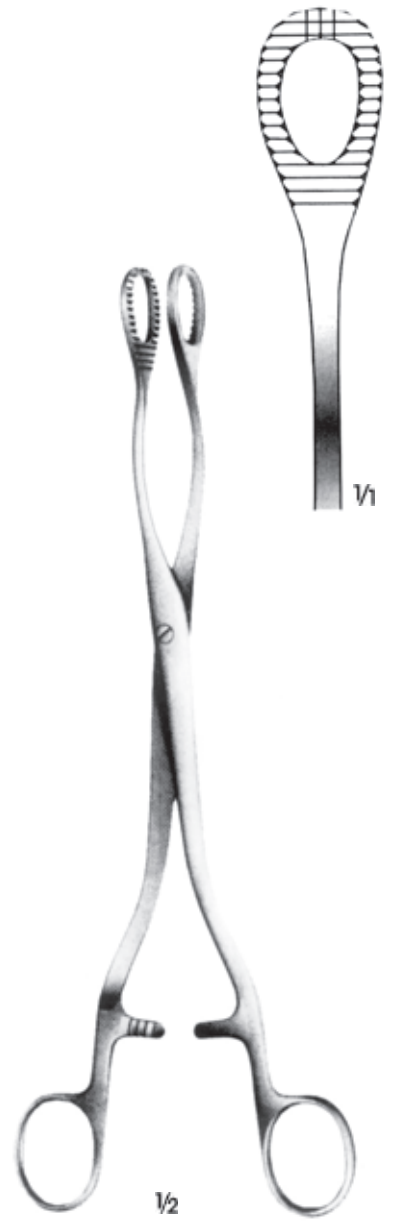
KELLY  
32 cm



1/2

NOTO  
44-185  
28 cm

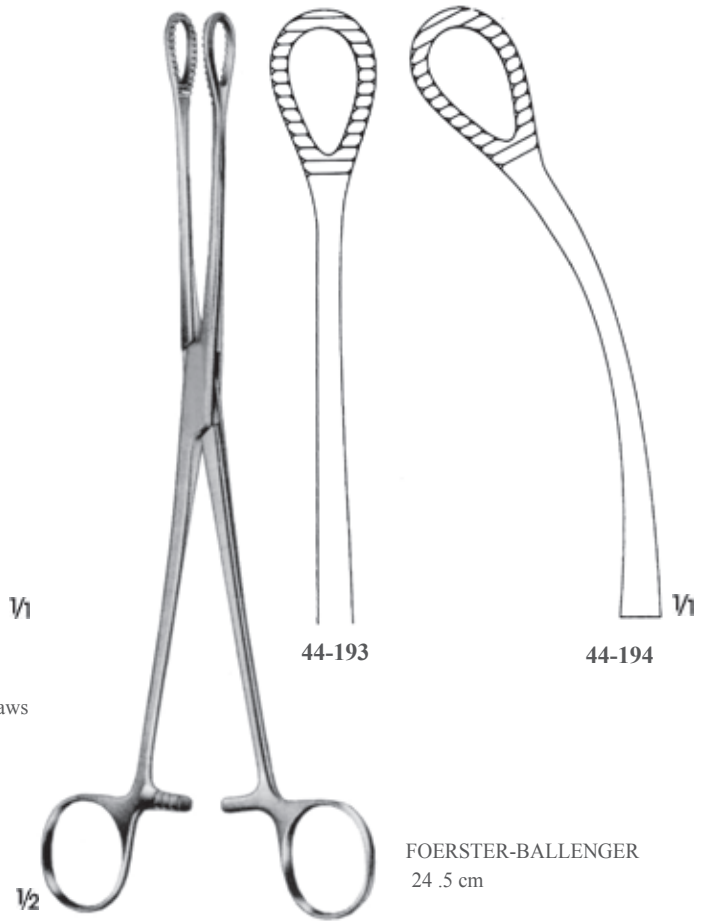
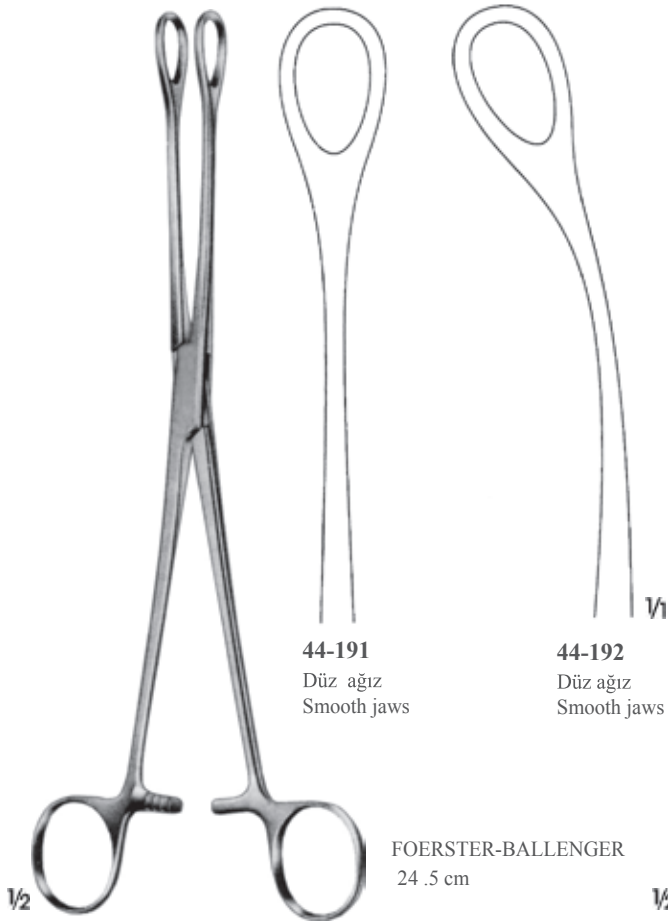
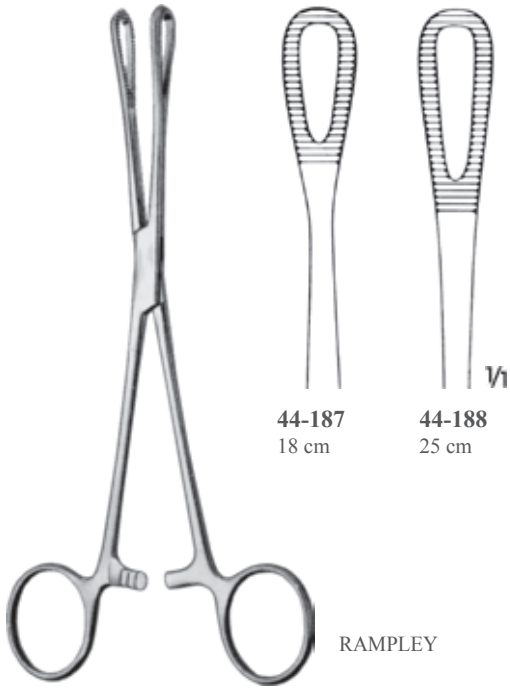
1/1



1/2

HEYWOOD-SMITH  
44-186  
25 cm

1/1





HEYWOOD-SMITH  
44-195  
20 cm



44-196  
16 cm

COLLIN

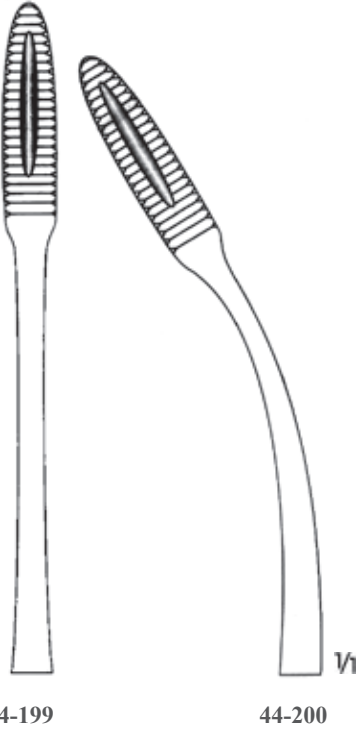


44-197  
17 cm



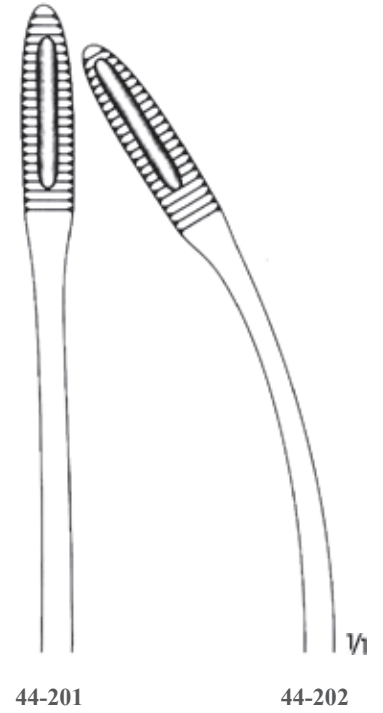
HEYWOOD-SMITH  
44-198  
21.5 cm





44-199

44-200



44-201

44-202



1/2

MAIER  
Kilitli/With ratchet  
26.5 cm



1/2

MAIER  
Kilitlessiz/Without  
ratchet 26.5 cm



SIMS-MAIER



44-203  
28 cm



44-204  
28 cm



44-205  
35 cm



1/2

24 cm

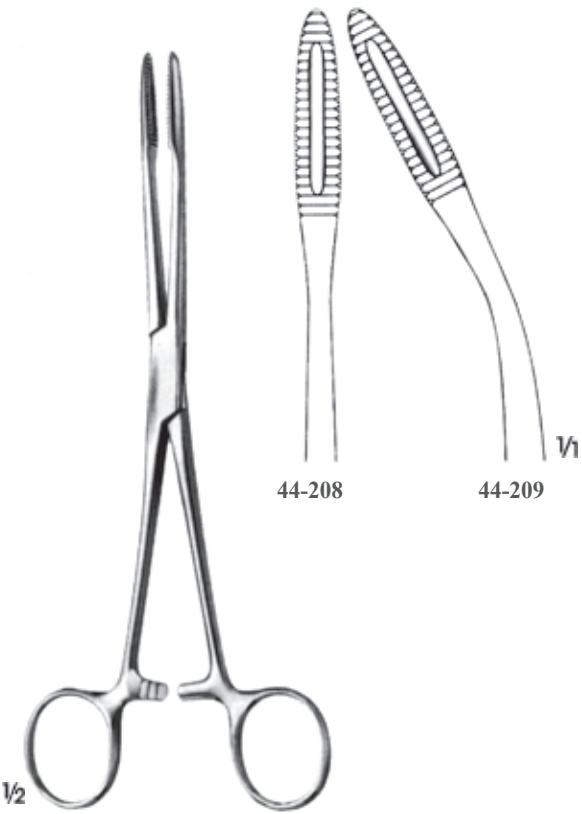


44-206

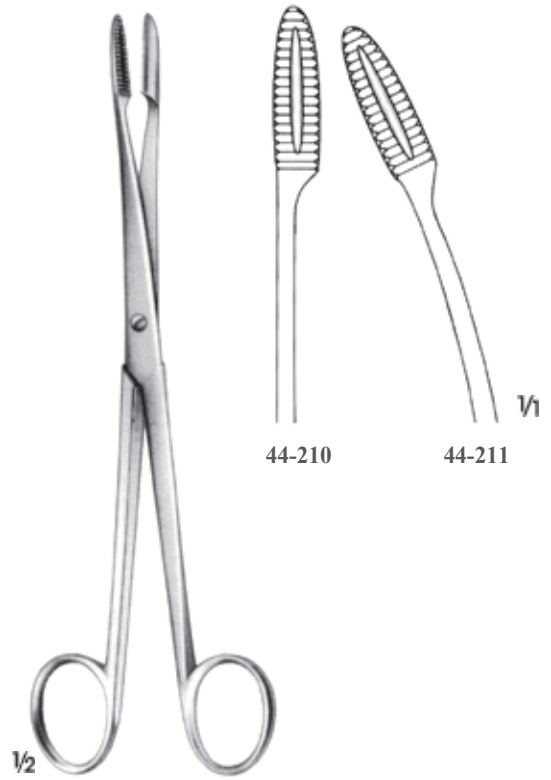


44-207

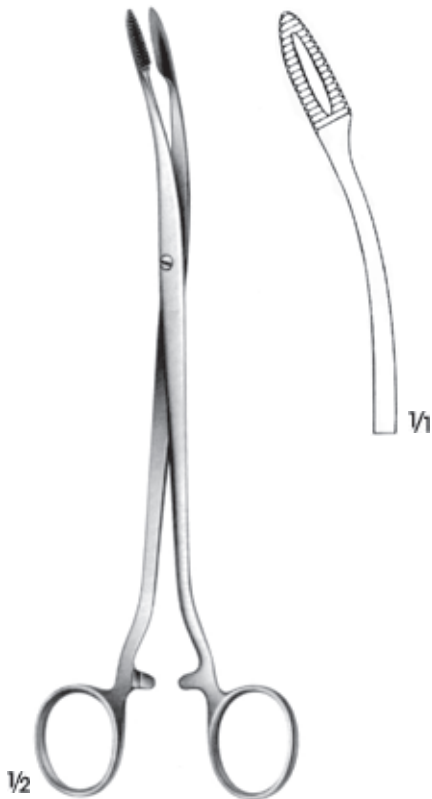
1/1



GROSS  
T14-130 - T14-131  
20 cm



GROSS  
T14-132 - T14-133  
Kilitsiz/Without ratchet  
20 cm



DUPLAY  
44-212  
21 cm



DUPLAY  
44-213  
19 cm



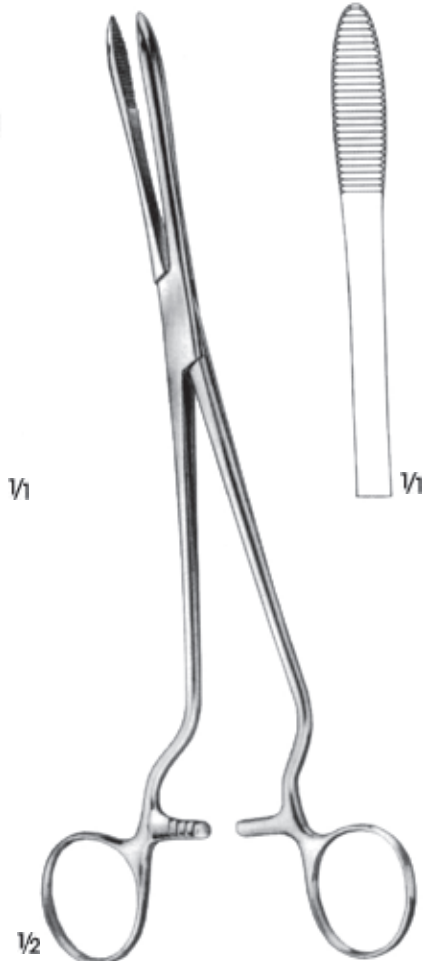




EMMET  
44-214  
21 cm



COLLIN  
44-215  
24 cm



CHERON  
44-216  
Açılı saplar  
Handles angled to side  
24 cm

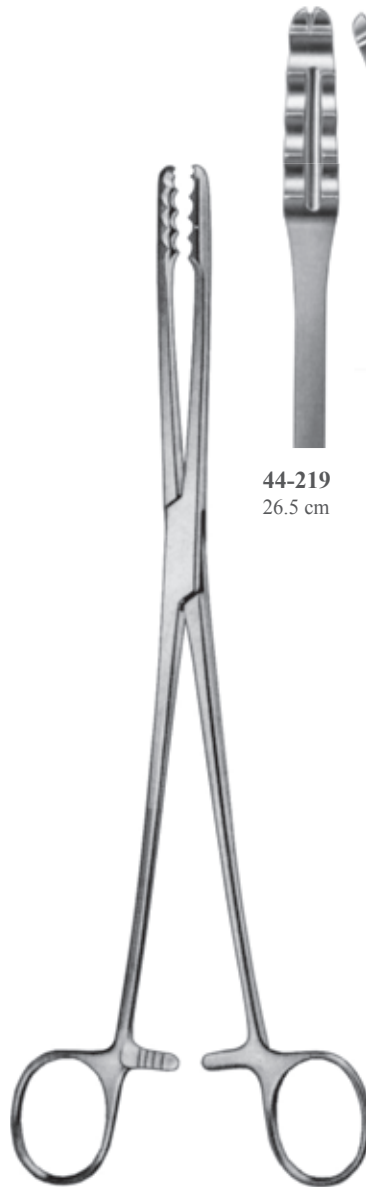


44-217

22 cm



44-218



44-219  
26.5 cm

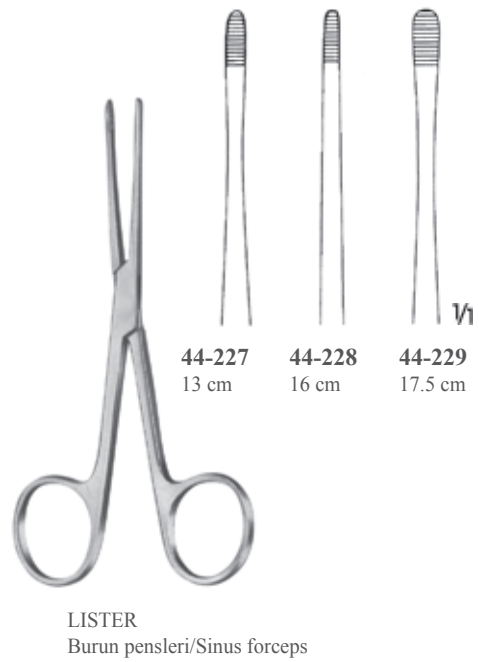
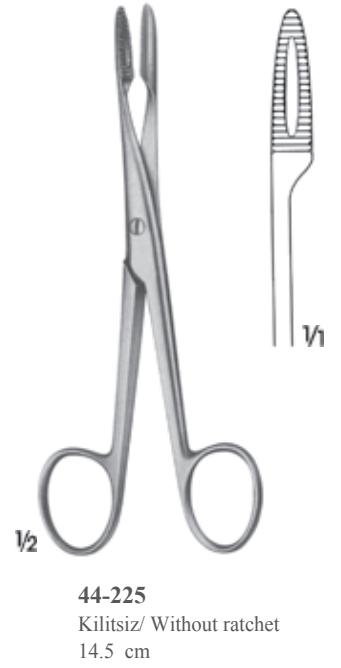
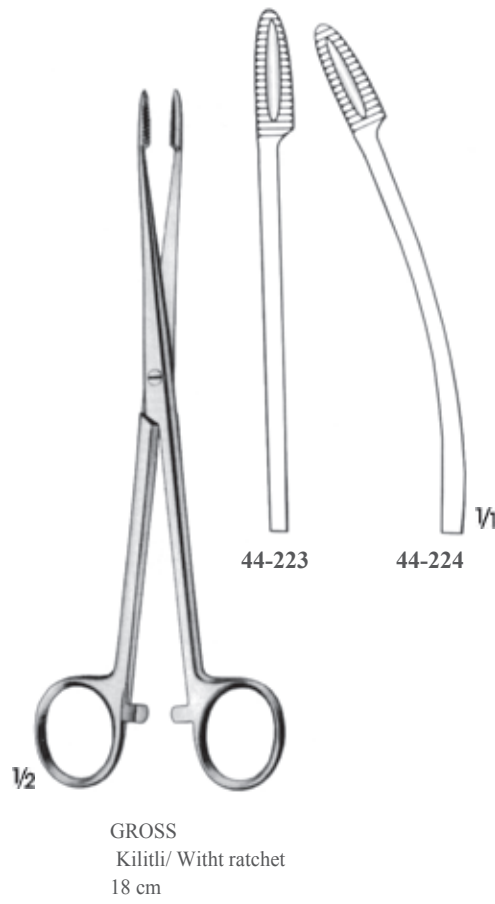
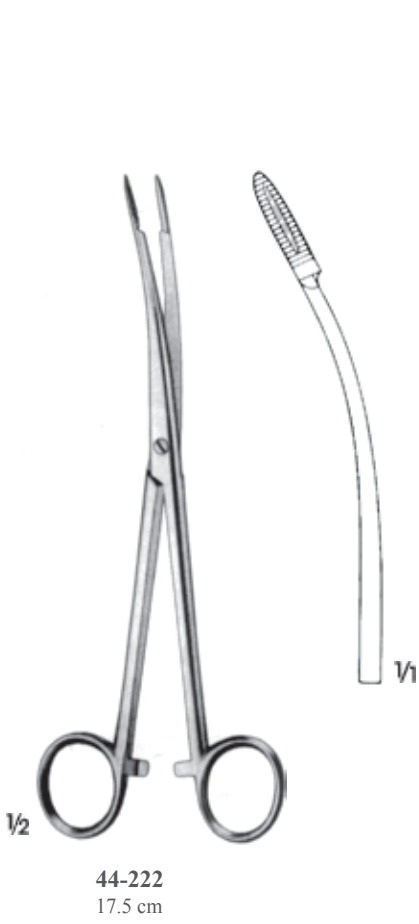


44-220  
26.5 cm



44-221  
35 cm

ULRICH

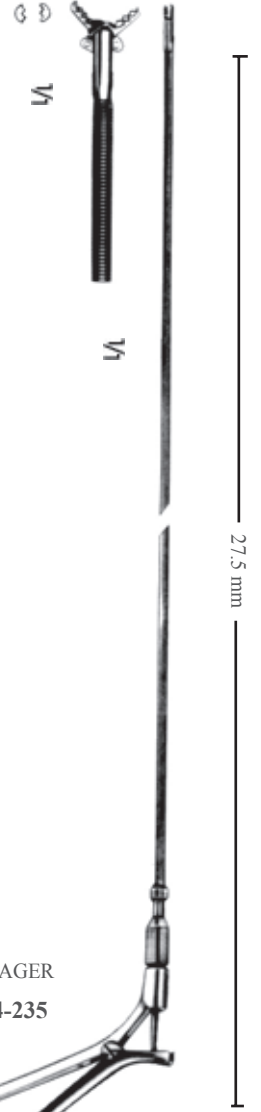




KLEINERT-KUTZ  
44-230

Tendon passing forceps  
20.5 cm

Tendon geçiş pensi



JAGER  
44-235

Tendon-and cross ligament passing  
forceps flexible shaft  
27.5 cm

Tendon ve çapraz bağlara geçiş  
sağlayan pens, esnek shaft



44-231  
Düz/Straight  
18.5 cm



44-232  
Eğri/Curved  
18.5 cm



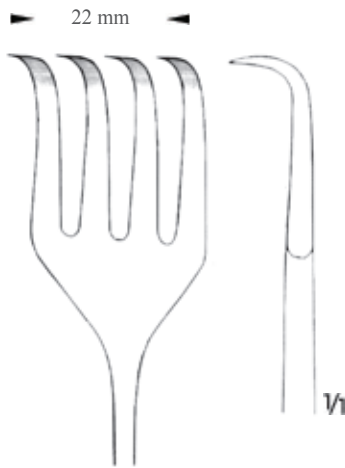
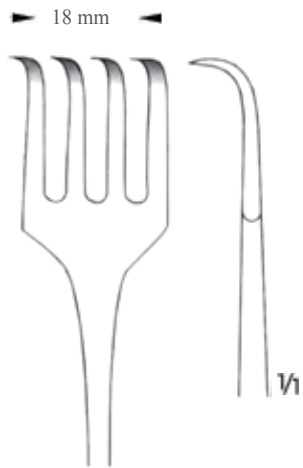
44-233  
Düz/Straight  
15 cm



44-234  
Eğri/Curved  
15 cm



BRAND  
Tendon tutma pensleri  
Tendon holding forceps



44-236  
26 cm



PRATT  
44-237  
27 cm

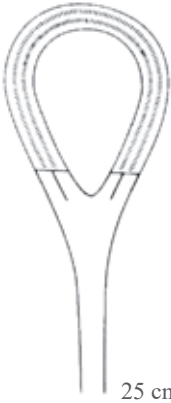
De Bakey Diş



Toothing De Bakey

21 mm

27 mm



44-238

25 cm



44-239

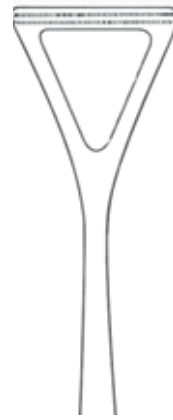
27 cm



2/3 sıra diş  
2/3 teeth rows

21 mm

23 mm



44-240



44-241

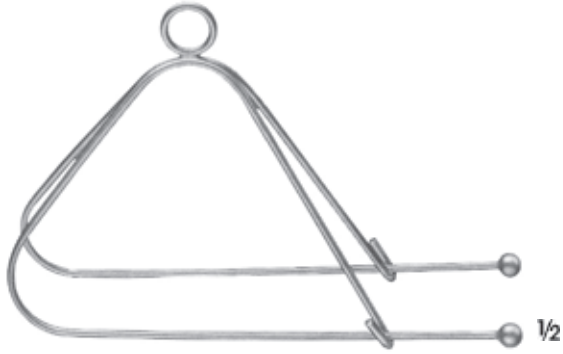


COLLIN

19.5 cm

23 cm





MAYO  
44-244  
Çift/double  
12.5 cm



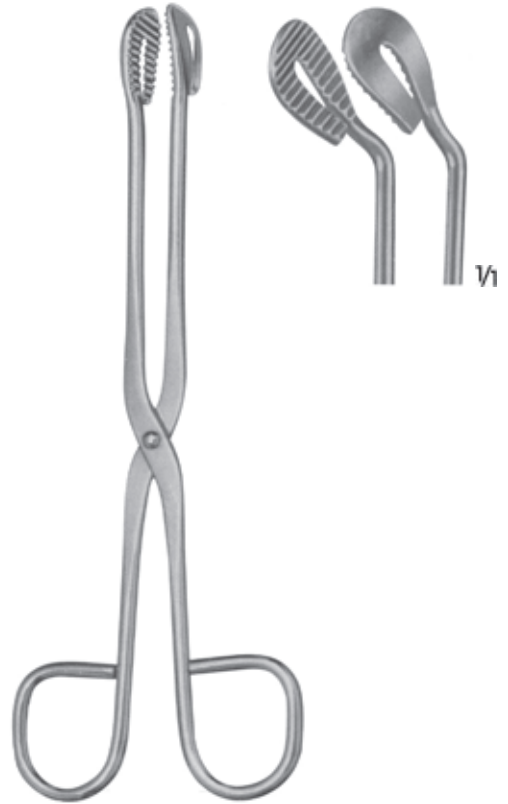
BUNT  
44-243  
10.5 cm



MAYO  
44-242  
14 cm



1/3  
CHEATTLE  
44-245  
Sterilizatör pens  
Sterilizing forceps  
28 cm



1/1  
44-246 20 cm  
44-247 30 cm  
Sterilizatör pensleri  
Sterilizing forceps

**45-**







45-100  
Approximator

Derin aralıkta mikro damar anastomileri için.

- Güvenli ve dikkatli şekilde damar kavrama.
- Tırtıklı yüzeyli bleydler.
- El ile basınç ayarı yapabilme özelliği.
- Mesafeyi el ile yakınlaştırma ve uzaklaştırma.

For micro vessel anastomosis

- Safe and careful gripping of vessel.
- Blades with serrated blade surface
- The ability to manually set the pressure distance, in and out manually.



BIEMER  
45-101

Derin aralıkta mikro damar anastomileri için.

- Güvenli ve dikkatli şekilde damar kavrama.
- Tırtıklı yüzeyli bleydler.

For micro vessel anastomosis

- Safe and careful gripping of vessel.
- Blades with serrated blade surface
- 



BIEMER  
45-102  
Komple Aproksimatör,  
Approximator, complete

Sinir anastomilerine güvenli adaptasyon

- Sinir merkezinin, güçlü patolojik değişiklikleri önleyen hassas iğneler ile delinmesi
- 
- 

Safe adaptation of nerve anastomoses

- Piercing the nerve center with fine needles that prevents strong pathological changes
- 



Geçici damar tıkkama için:

Güvenli ve dikkatli şekilde damar kavrama

Sabitlenmiş baskı mesafeli, tırtıklı yüzeyli bleydler

Kapama kuvveti klipsin ağızlarının 1/3 mesafesinde 1 mm aralık durumunda ölçülür.

For temporary occlusion :

Safe and careful gripping of vessel

Blades with serrated surface and rigidly fixed pressure feature

Closing force is measured at 1/3 of the blades a 1 mm opening



BIEMER  
**45-103**

Çene uzunluğu/Lenght of jaws 6 mm

Açıklık/Opening 4 mm

Kapanma kuvveti/Closing force 30-40 gr. (0.29 - 0.39 N)



**45-104**

Çene Uzunluğu/Lenght of jaws 9 mm

Açıklık/Opening 5 mm

Kapanma kuvveti/Closing force 30-40 gr. (0.29 - 0.39 N)



BIEMER  
**45-105**

Çene uzunluğu/Lenght of jaws 9 mm

Açıklık/Opening 5 mm

Kapanma kuvveti/Closing force 20-25 gr. (0.20 - 0.25 N)

for vessel Ø 0.5 - 2.0 mm.



MEHDORN  
**45-106**

Çene uzunluğu/Lenght of jaws 1 mm

Açıklık/Opening 4 mm

Kapanma kuvveti/Closing force 10-15 gr. (0.10 - 0.15 N)



MEHDORN  
**45-107**

Çene uzunluğu/Lenght of jaws 1.4 mm

Açıklık/Opening 4 mm

Kapanma kuvveti/Closing force 15-20 gr. (0.15 - 0.20 N)

MEHDORN  
**45-108**

Çene uzunluğu/Lenght of jaws 1 mm

Açıklık/Opening 6 mm

Kapanma kuvveti/Closing force 10-15 gr. (0.10 - 0.15 N)



MEHDORN  
**45-109**

Çene uzunluğu/Lenght of jaws 1.4 mm

Açıklık/Opening 6 mm

Kapanma kuvveti/Closing force 15-20 gr. (0.15 - 0.20 N)

for vessel Ø 0.5 - 2.0 mm.

Mikro damar anastomileri için:  
Güvenli ve dikkatli şekilde damar kavrama.  
Sabitlenmiş baskı mesafeli, tırtıllı yüzeyli bleydler.  
Klipsler arası mesafe ayarlanabilir.  
Bükerek otomatik sabitleme.

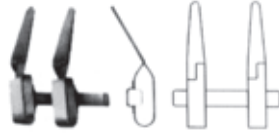
For micro vessel anastomosis:  
Safe and careful gripping of vessel.  
Blades with serrated surface and rigidly fixed pressure feature.  
Adjustable distance between clips.  
Automatic fixation by tilling



BIEMER-MÜLLER  
**45-110**  
Çene uzunluğu/Lenght of jaws.6 mm  
Açıklık/Opening 4 mm  
Kapanma kuvveti/Closing force 30-40 gr.



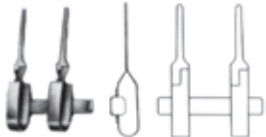
BIEMER-MÜLLER  
**45-111**  
Çene uzunluğu/Lenght of jaws.4.5 mm  
Açıklık/Opening 3 mm  
Kapanma kuvveti/Closing force 25-30 gr.



BIEMER-MÜLLER  
**45-112**  
Çene uzunluğu/Lenght of jaws.9 mm  
Açıklık/Opening 5 mm  
Kapanma kuvveti/Closing force 25-30 gr.



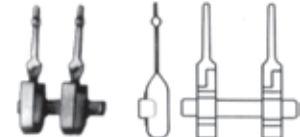
BIEMER-MÜLLER  
**45-113**  
Çene uzunluğu/Lenght of jaws.9 mm  
Açıklık/Opening 5 mm  
Kapanma kuvveti/Closing force 25-30 gr.



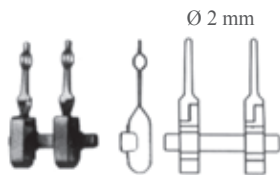
BIEMER-MÜLLER  
**45-114**  
Çene uzunluğu/Lenght of jaws.9 mm  
Açıklık/Opening 5 mm  
Kapanma kuvveti/Closing force 25-30 gr.



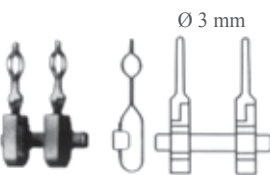
BIEMER-MÜLLER  
**45-115**  
Çene uzunluğu/Lenght of jaws.9 mm  
Açıklık/Opening 5 mm  
Kapanma kuvveti/Closing force 25-30 gr.



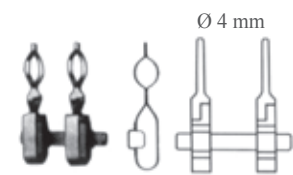
MÜLLER  
**45-116**  
Kapanma kuvveti/Closing force. 25-30 gr.



MÜLLER  
**45-117**  
Kapanma kuvveti/Closing force. 25-30 gr.



MÜLLER  
**45-118**  
Kapanma kuvveti/Closing force. 25-30 gr.



MÜLLER  
**45-119**  
Kapanma kuvveti/Closing force. 25-30 gr.



Toplam boy  
Total length

Ağız uzunluğu  
Length of jaws

DIEFFENBACH

**45-120** 38 mm 12 mm  
**45-121** 48 mm 16 mm



Toplam boy  
Total length

Ağız uzunluğu  
Length of jaws

DIEFFENBACH

**45-122** 38 mm 12 mm  
**45-123** 48 mm 16 mm



Toplam boy  
Total length

Ağız uzunluğu  
Length of jaws

DIEFFENBACH

**45-124** 58 mm 16 mm



Toplam boy  
Total length

Ağız uzunluğu  
Length of jaws

DIEFFENBACH

**45-125** 58 mm 16 mm



Toplam boy  
Total length

Ağız uzunluğu  
Length of jaws

DE BAKEY-HESS

**45-126** 34 mm 20mm  
**45-127** 43 mm 30mm



Toplam boy  
Total length

Ağız uzunluğu  
Length of jaws

JOHNS-HOPKINS

**45-128** 38 mm 12 mm  
**45-129** 48 mm 17 mm  
**45-130** 56 mm 25 mm  
**45-131** 63 mm 30 mm  
**45-132** 70 mm 33 mm  
**45-133** 80 mm 42 mm  
**45-134** 91 mm 52 mm



JOHNS-HOPKINS

**45-135**

Buldog klemplerin takılması ve çıkarılması için pens



V1

BIEMER  
45-136  
Kilitsiz/Without lock



V1

BIEMER  
45-137  
Kilitli/With lock



V1



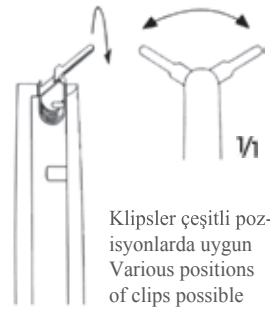
V1

BIEMER  
45-138  
Uygulama pensetleri, damar klipsleri,  
BIEMER-MÜLLER ve MÜLLER apüksio-  
matör.  
Applying forceps for BIEMER  
vessel approximator  
14.5 cm



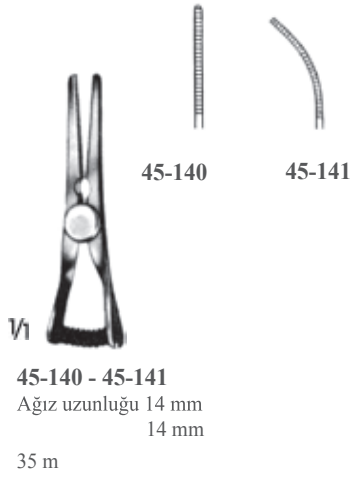
V1

MEHDORN  
45-139  
Uygulama pensetleri, MEHDORN  
damar klipsleri  
Applying forceps for MEHDORN  
vessel clips  
15 cm



Klipsler çeşitli pozisyonlarda uygun  
Various positions of clips possible

BIEMER  
45-140 - 45-141  
BIEMER damar klipsleri ve BIEMER-MÜLLER ve  
MÜLLER yaklaştırıcılar için başvuru pensleri  
Applying forceps for BIEMER vessel clips and  
BIEMER-MÜLLER and MÜLLER approximators  
14 cm



Length of jaws 19 mm

Length of jaws 19 mm

Length of jaws



De Bakey Diş



Toothing De BAkey



Toplam boy  
Total length

Ağız uzunluğu  
Length of jaws

DE BAKEY

<b>45-147</b>	8.0 cm	25 mm
<b>45-148</b>	9.0 cm	35 mm
<b>45-149</b>	10.5 cm	50 mm
<b>45-150</b>	12.4 cm	68 mm

Toplam boy  
Total length

Ağız uzunluğu  
Length of jaws

DE BAKEY

<b>45-151</b>	7.8 cm	23 mm
<b>45-152</b>	8.6 cm	31 mm
<b>45-153</b>	9.7 cm	42 mm
<b>45-154</b>	11.4 cm	58 mm



1/2

DE BAKEY  
**45-155**

Ağız uzunluğu 27 mm  
Length of jaws 27 mm  
5 cm



75°

1/2

GLOVER  
**45-156**

Ağız uzunluğu 35 mm  
Length of jaws 35 mm  
5.2 cm



Toplam boy  
Total length

Ağız uzunluğu  
Length of jaws

GLOVER

<b>45-157</b>	33 mm
<b>45-158</b>	50 mm
<b>45-159</b>	69 mm



Toplam boy  
Total length

Ağız uzunluğu  
Length of jaws

GLOVER

<b>45-160</b>	6.5 cm	33 mm
<b>45-161</b>	9.1 cm	50 mm
<b>45-162</b>	11 cm	69 mm



DE BAKEY  
**45-163**

Ağız uzunluğu 27 mm  
Length of jaws 27 mm  
4.8 cm



21 cm

1/1

1/2

DE BAKEY  
**45-164**

Ağız uzunluğu 38 mm  
Length of jaws 38 mm  
7.3 cm



21 cm

1/1

1/2

DE BAKEY  
**45-165**

Ağız uzunluğu 63 mm  
Length of jaws 63 mm  
9.9 cm

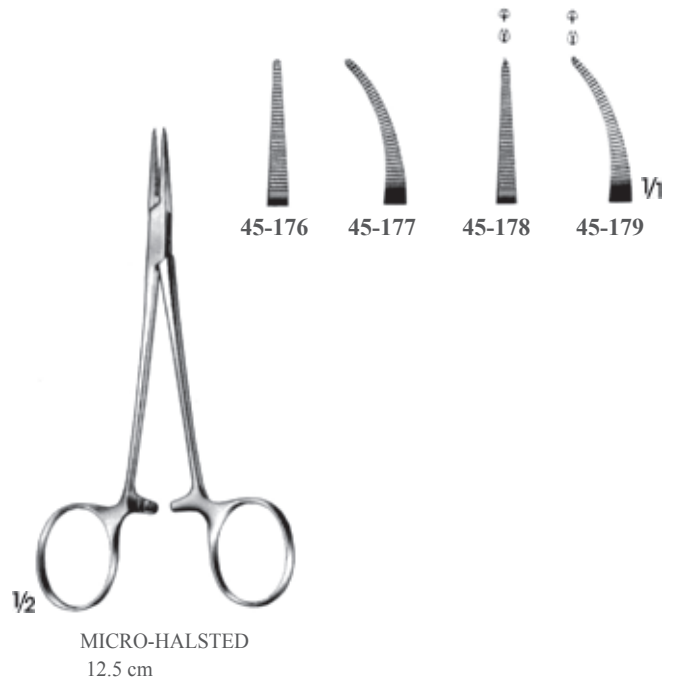
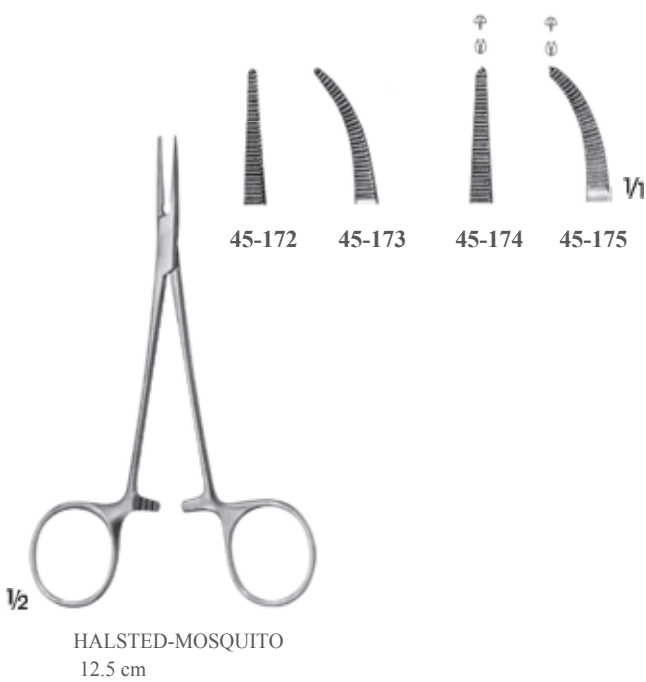
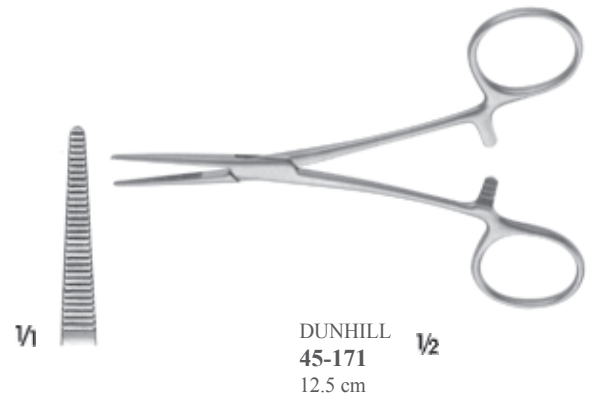
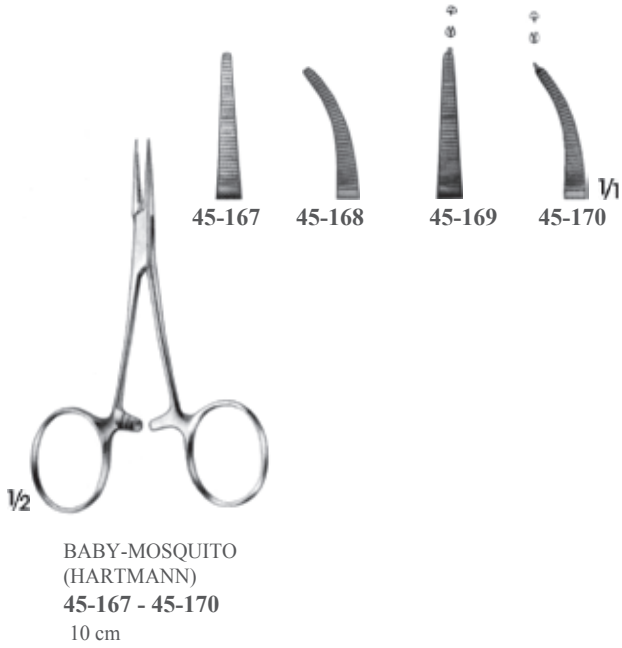


1/2

DE BAKEY  
**45-166**

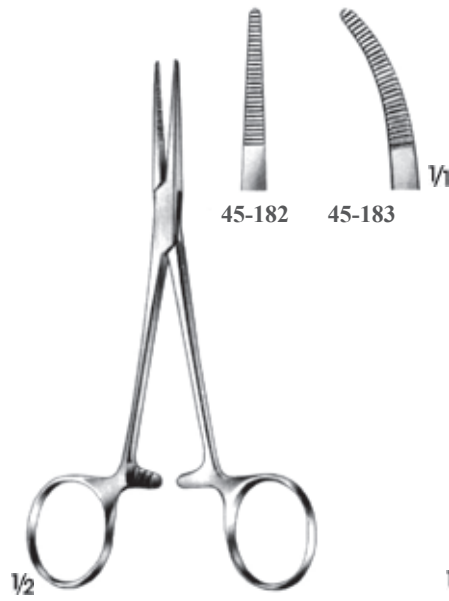
Ağız uzunluğu 54 mm  
Length of jaws 54 mm  
9.5 cm



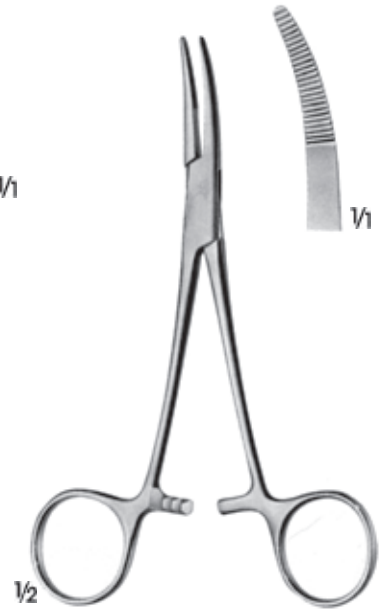




PROVIDENCE-HOSPITAL  
45-180 - 45-181  
14 cm



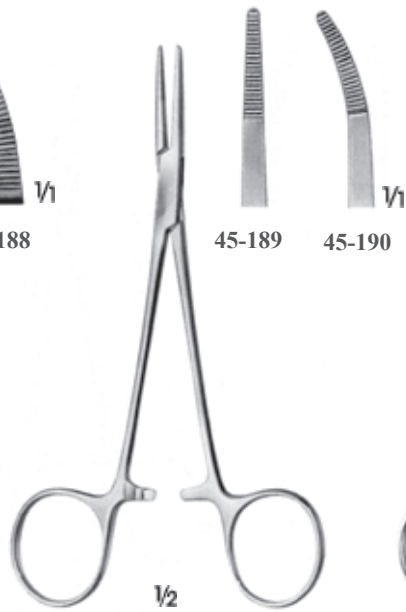
KELLY  
45-182 - 45-183  
14 cm



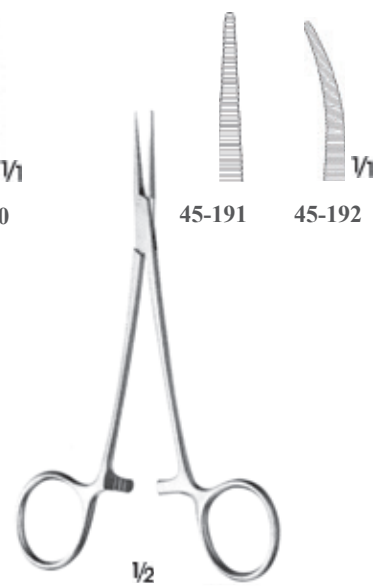
MOYNIHAN  
45-184  
Yana eğimli/Curved to side  
15 cm



BABY-CRILE  
14 cm



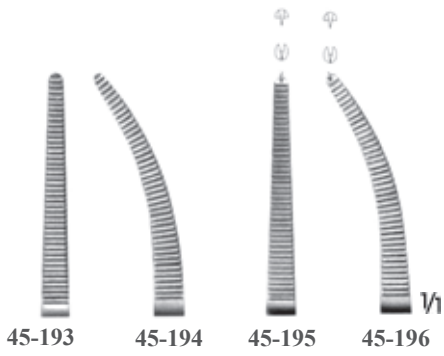
CAIRNS  
15 cm



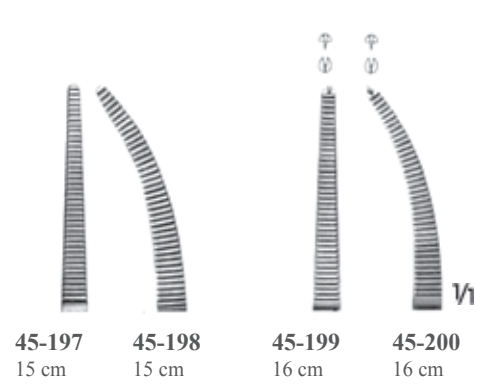
JACOBSON  
12.5 cm



CRILE  
14 cm



LERICHE



DANDY

Yana eğimli/Curved to side  
14 cm



CAIRNS  
45-203  
Yana eğimli/Curved to side  
14.5 cm





PEAN

45-204  
13 cm

45-205  
14 cm

45-206  
13 cm

45-207  
14 cm



PEAN

45-208  
13 cm

45-209  
14 cm

45-210  
14 cm



SPENCER - WELLS

45-211  
13 cm

45-212  
15 cm

45-213  
17.5 cm

45-214  
20 cm

45-215  
13 cm

45-216  
15 cm

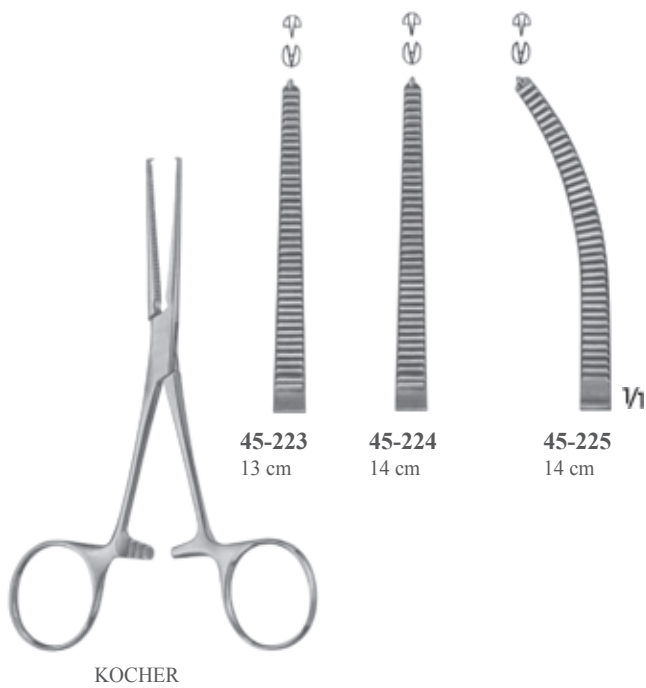
45-217  
17.5 cm

45-218  
20 cm

45-219  
23 cm

Ince model/Slender type







COLLER

45-228  
14 cm



45-229  
16.5 cm



45-230  
14 cm



45-231  
16.5 cm



1/2

RANKIN  
16 cm



45-232



45-233

1/1



1/2

CRILE  
16 cm



45-234



45-235

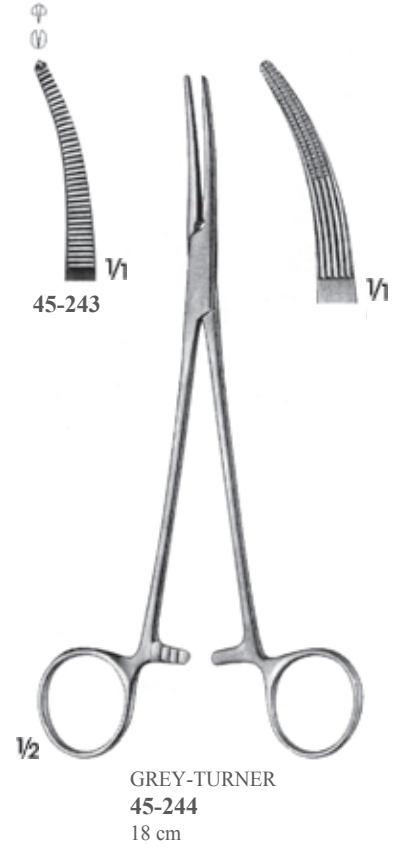
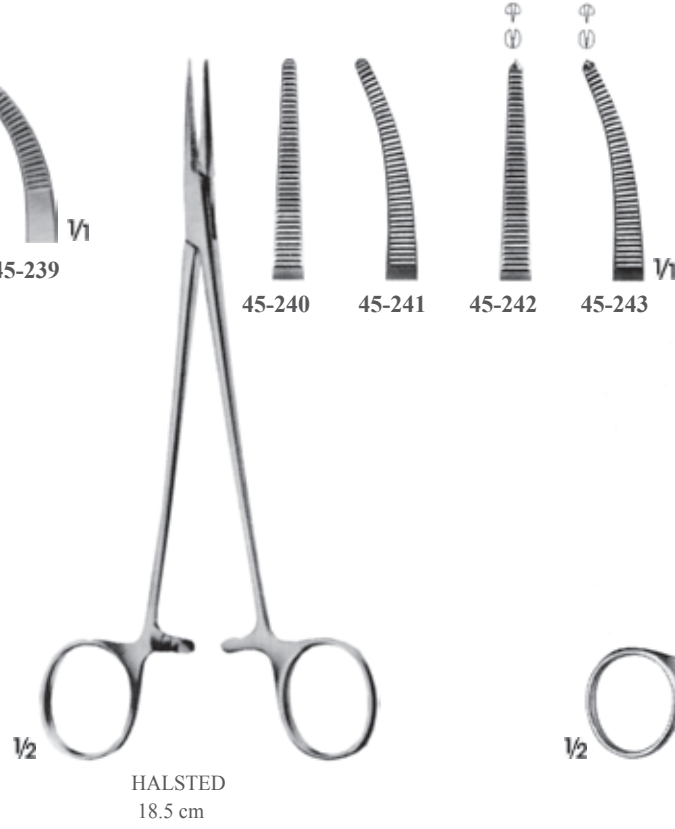


45-236



45-237

1/1





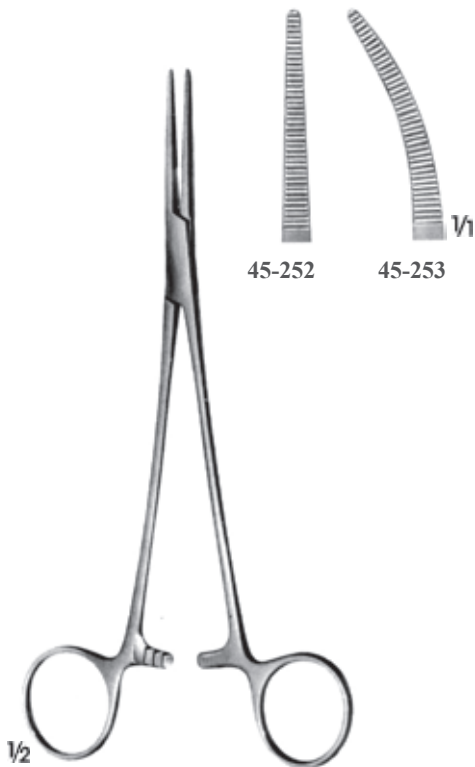
FRASER-KELLY(CRILE)  
45-249  
18 cm



DUNHILL  
45-250  
19 cm



JACOBSON  
45-251  
19 cm



BIRKETT  
18.5 cm



HALSTED-MOSQUITUO  
20 cm







HEISS

T45-258  
20 cm



45-259  
20 cm



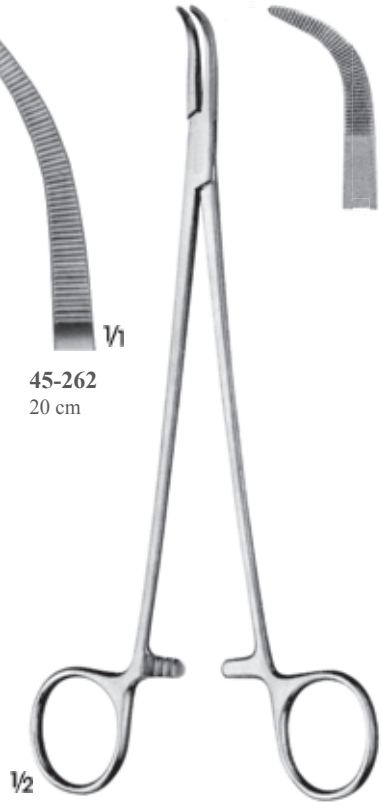
45-260  
19.5 cm



45-261  
20 cm



45-262  
20 cm



ADSON  
45-263  
21.5 cm

V1

1/2



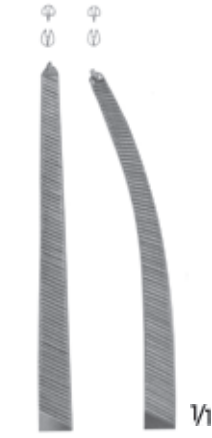
BENGOLA  
24.5 cm



45-264



45-265

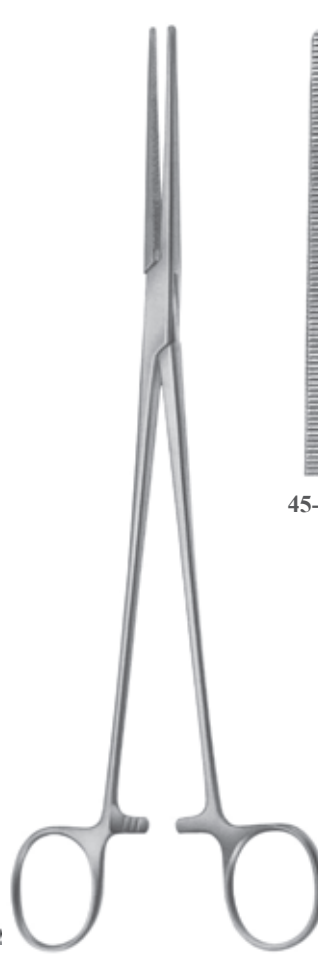


45-266



45-267

V1



SAROT  
24 cm



45-268



45-269

V1

1/2



45-270  
16 cm



45-271  
18.5 cm



45-272  
20 cm



45-273  
22.5 cm



45-274  
24 cm



45-275  
35 cm



V1



45-276  
16 cm



45-277  
18.5 cm



45-278  
20 cm



45-279  
22.5 cm



45-280  
24 cm



45-281  
35 cm



V1

ROCHESTER - PEAN

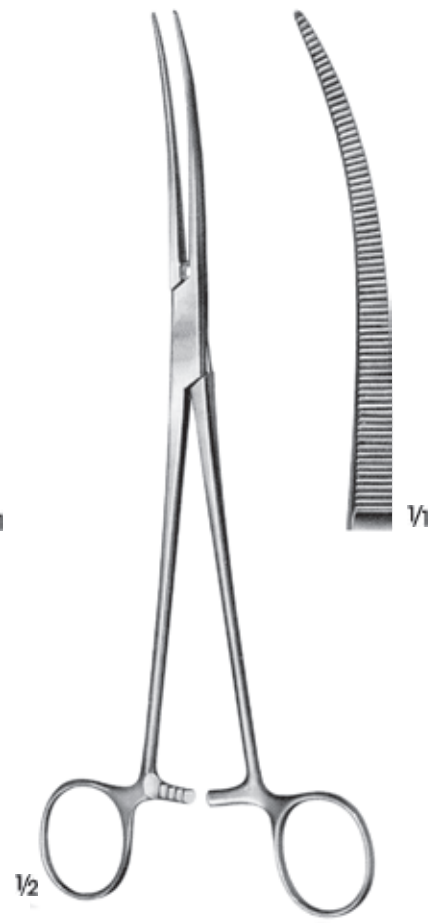




BRIDGE  
T15-198 - T15-199  
27.5 cm



CRAFOORD  
45-284  
24.5 cm



CRAFOORD, MOD.  
45-285  
24 cm





PEAN



45-286  
24 cm



45-287  
26 cm



45-288  
28 cm



45-289  
24 cm

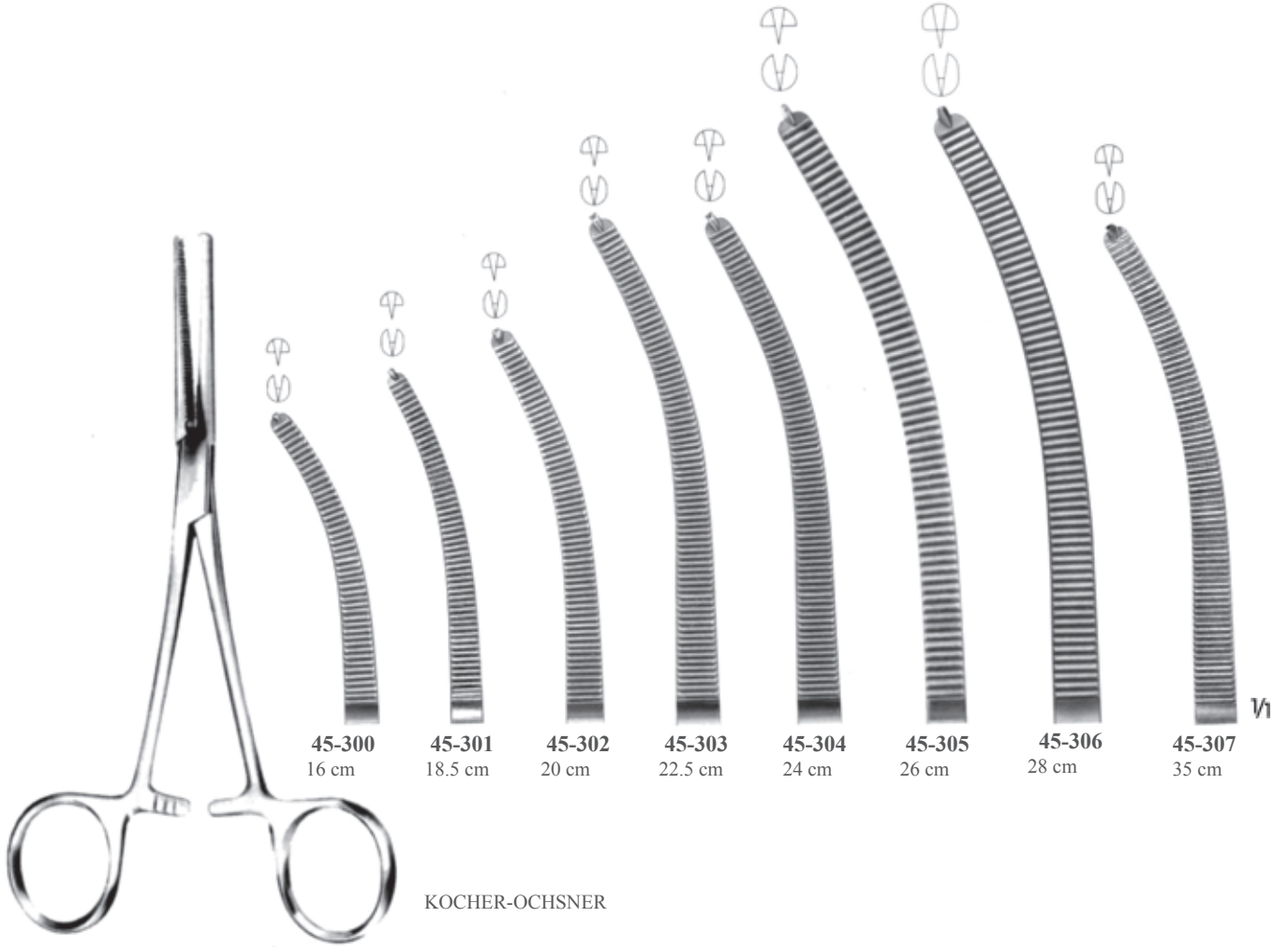
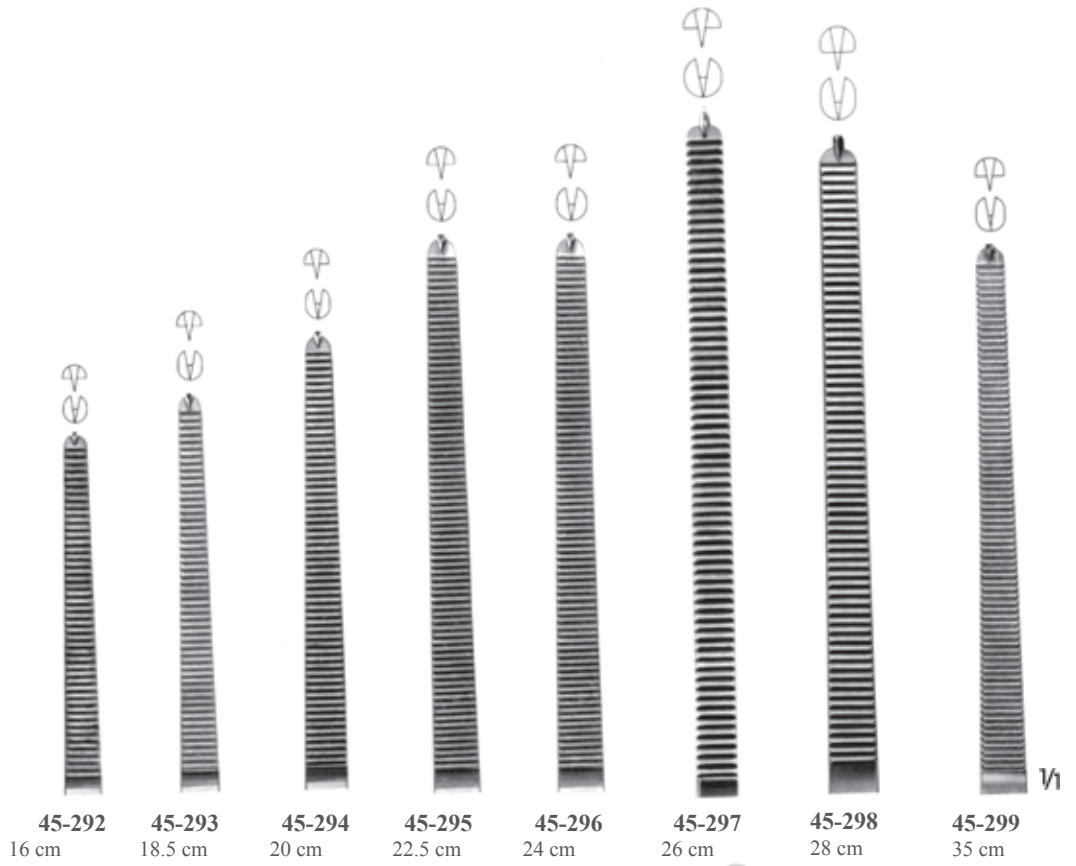


45-290  
26 cm



45-291  
28 cm

VI





ROCHESTER-CARMALT

45-308  
16 cm

45-309  
20 cm

45-310  
16 cm

45-311  
20 cm

1/2



45-312

45-313  
1x2 diş  
1x2 teeth

1/1

FICKLING  
18 cm



MOYNIHAN

45-314  
23 cm

45-315  
24 cm

1/1



45-316

45-317

1/1

ROBERTS  
25 cm

1/2



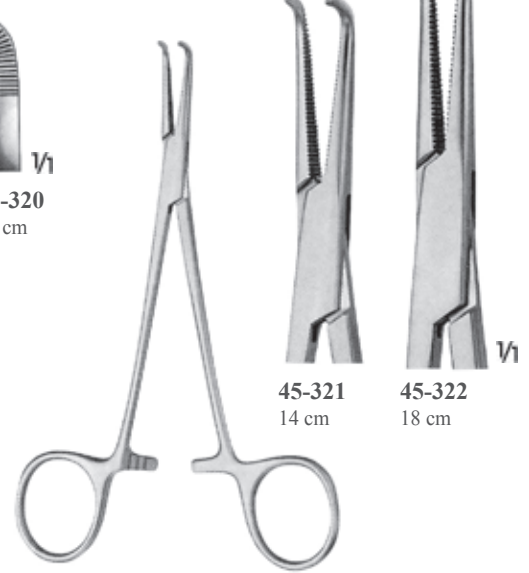
**MICRO-ADSON**  
**45-318**  
Diseksiyon pensi  
Dissecting forcep  
14 cm



**BABY-ADSON**  
Diseksiyon pensleri  
Dissecting forceps

**45-319**  
14 cm

**45-320**  
18 cm



Diseksiyon pensleri  
Dissecting forceps

**45-321**  
14 cm

**45-322**  
18 cm



**BABY-MIXTER**  
Diseksiyon pensleri  
Dissecting forceps

**45-323**  
14 cm

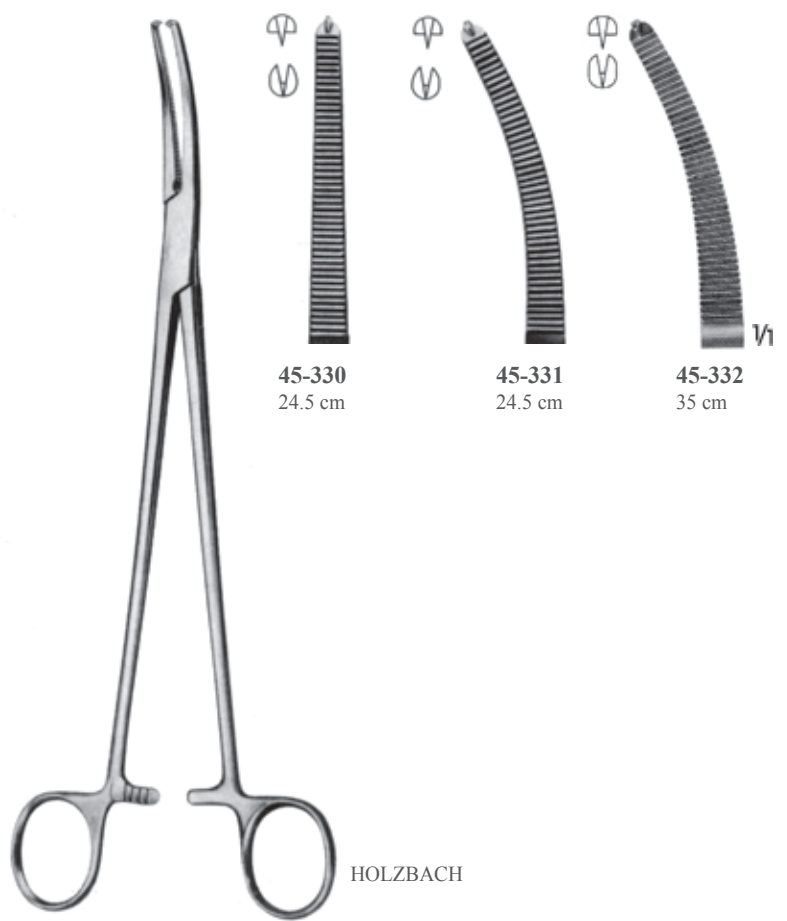
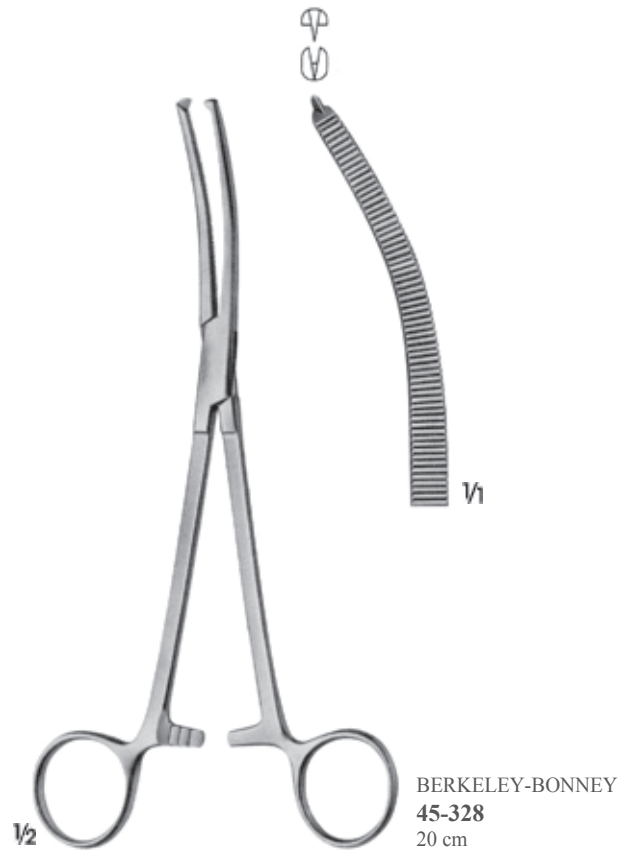
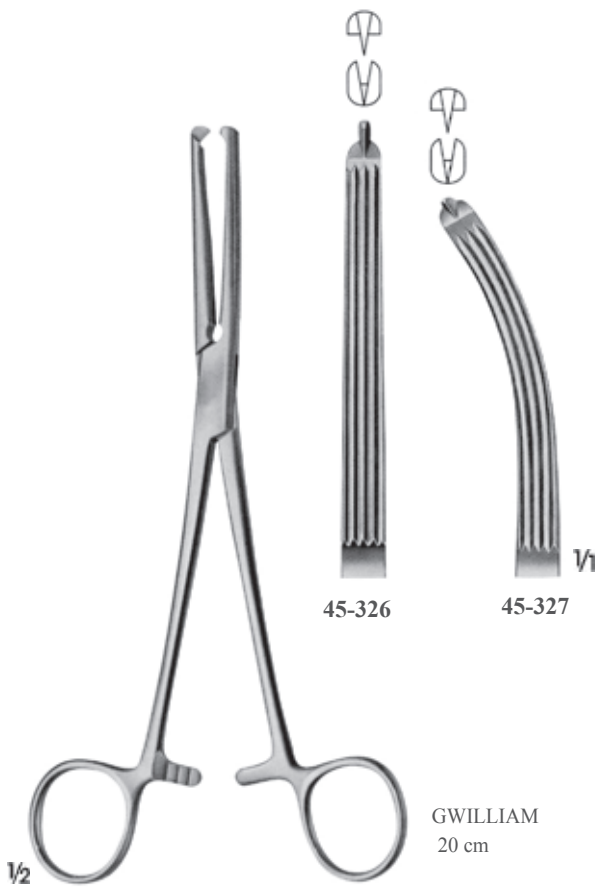
**45-324**  
18 cm



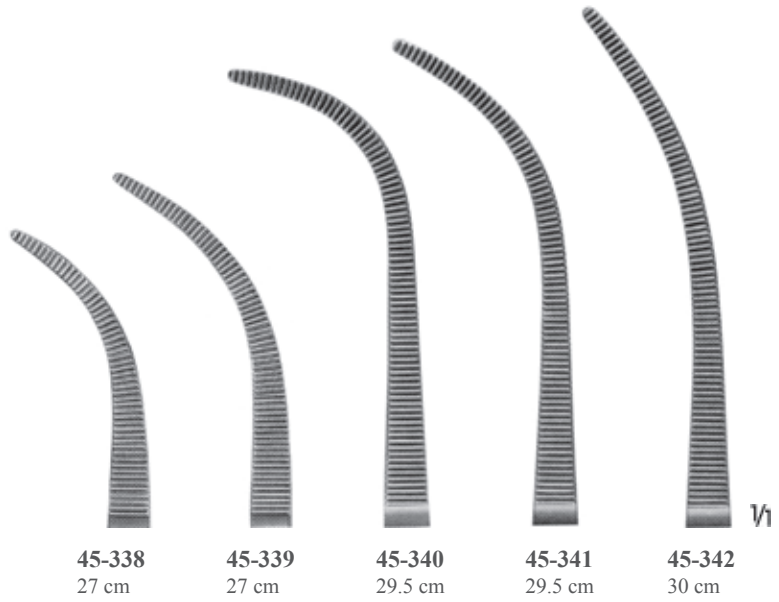
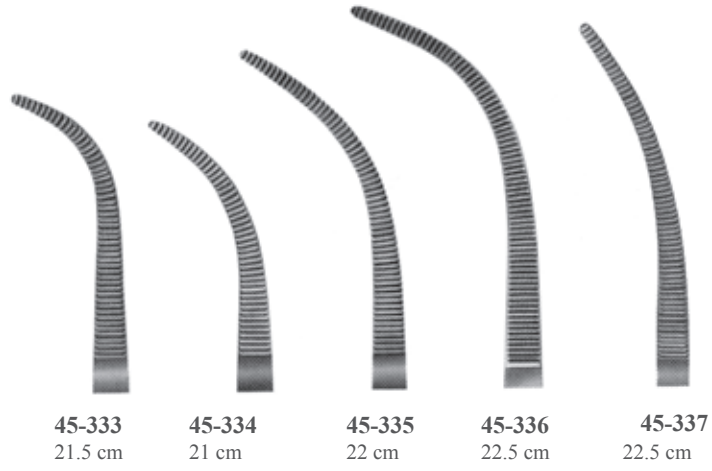
**BABY-OVERHOLT**  
**45-325**  
Diseksiyon pensi  
Dissecting forcep  
13.5 cm











OVERHOLT  
Hassas model/Delicate pattern



45-343  
15 cm



45-344  
18 cm



45-345  
20 cm



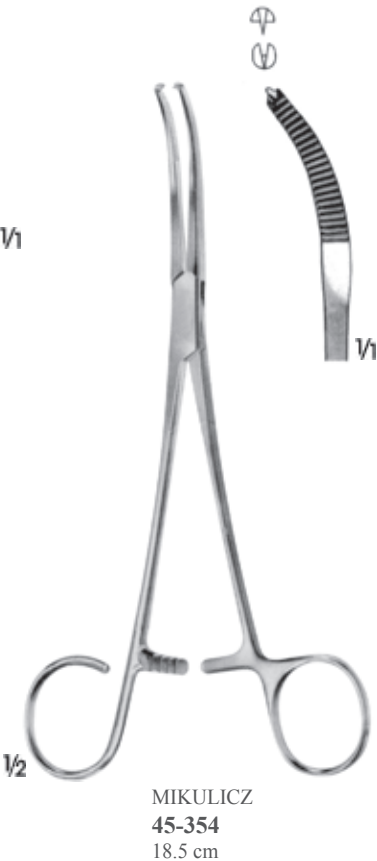
45-346  
23 cm

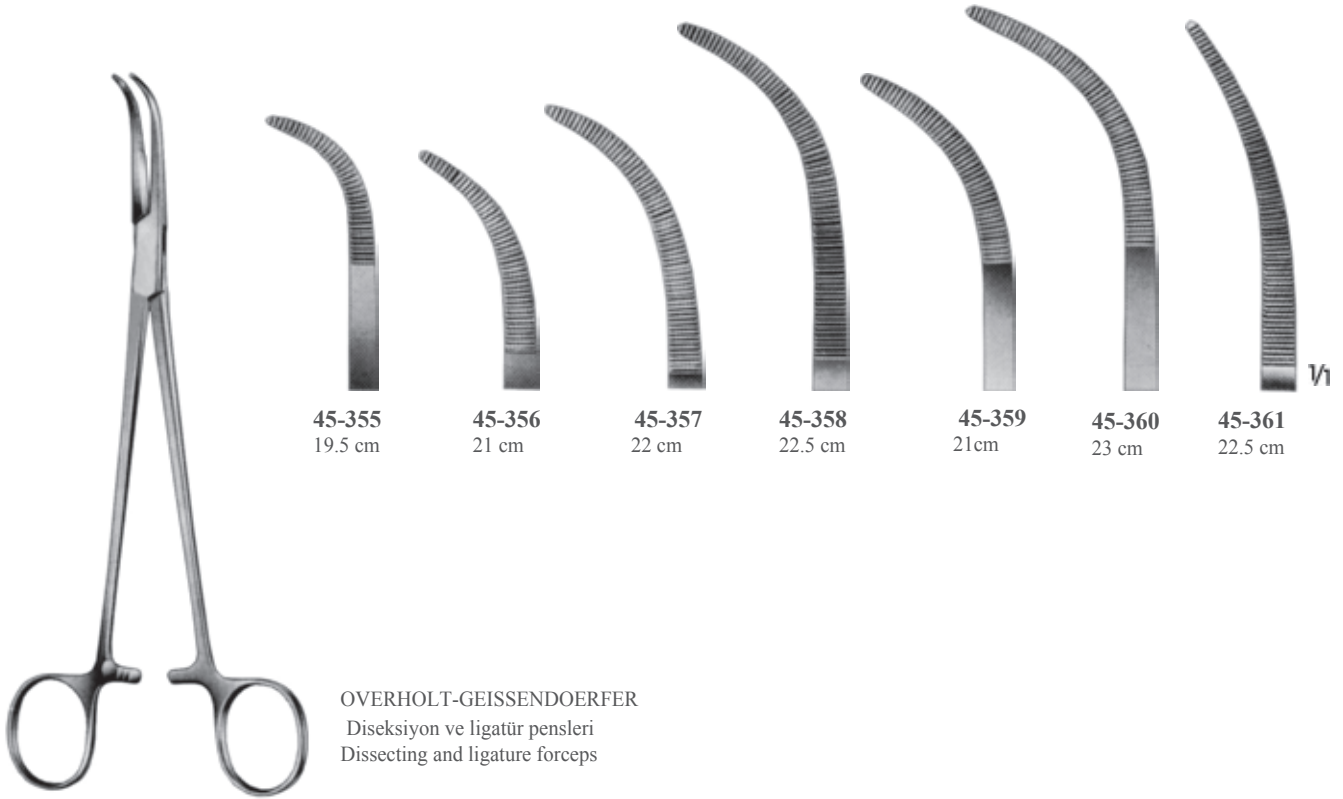


45-347  
25.5 cm

O'SHAUGHNESSY  
45-343 - 45-347







45-355  
19.5 cm

45-356  
21 cm

45-357  
22 cm

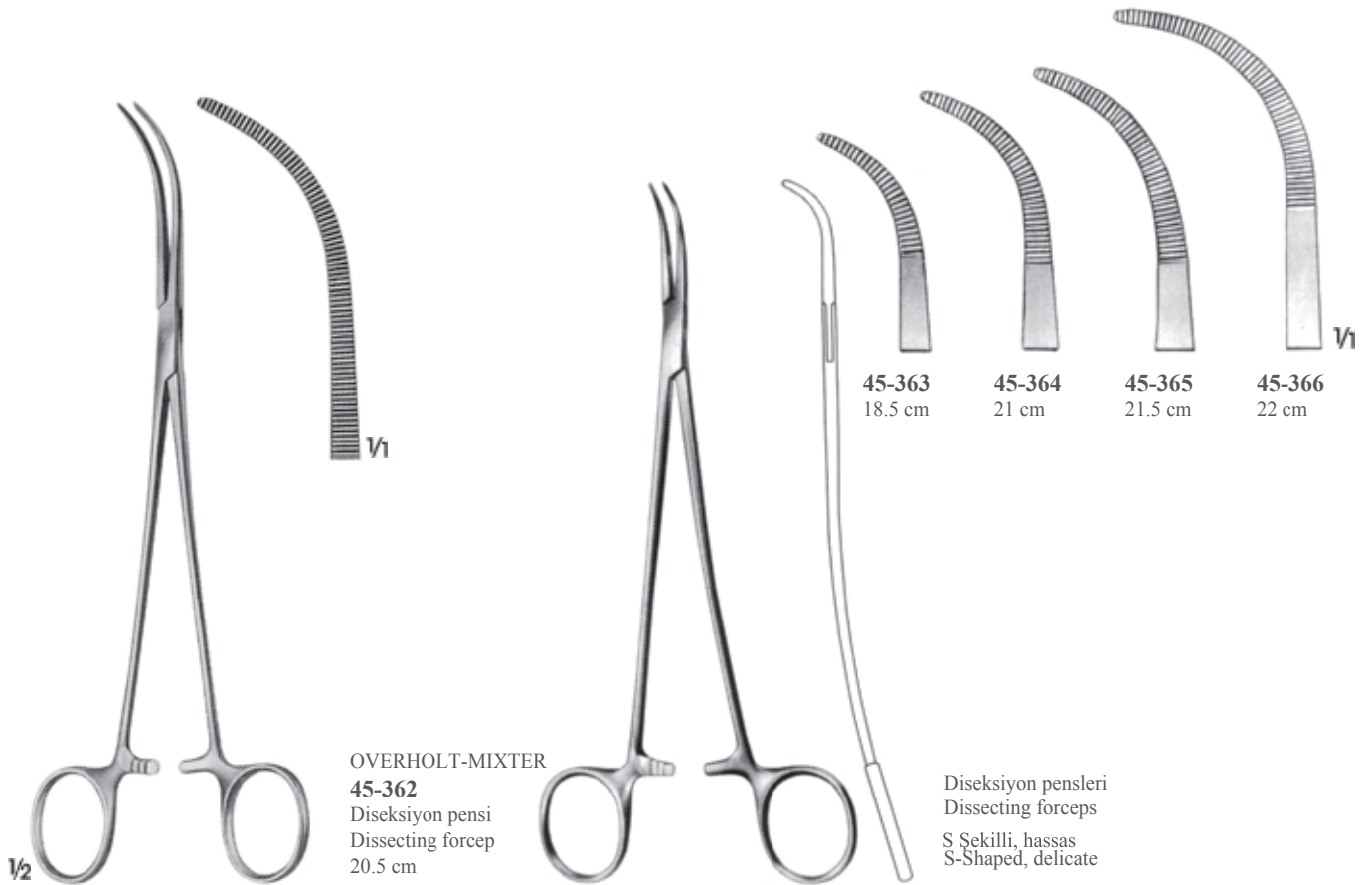
45-358  
22.5 cm

45-359  
21 cm

45-360  
23 cm

45-361  
22.5 cm

OVERHOLT-GEISSENDOERFER  
Diseksiyon ve ligatür pensleri  
Dissecting and ligature forceps



45-363  
18.5 cm

45-364  
21 cm

45-365  
21.5 cm

45-366  
22 cm

OVERHOLT-MIXTER  
45-362  
Diseksiyon pens  
Dissecting forceps  
20.5 cm

Diseksiyon pensleri  
Dissecting forceps  
S Şekli, hassas  
S-Shaped, delicate



GEMINI



45-367  
13 cm



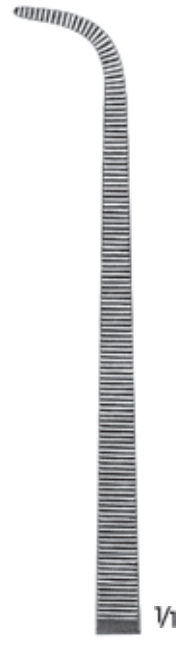
45-368  
18 cm



45-369  
20 cm



45-370  
23 cm



45-371  
28 cm



OVERHOLT-GEISSENDOERFER



45-372  
26 cm



45-373  
27 cm



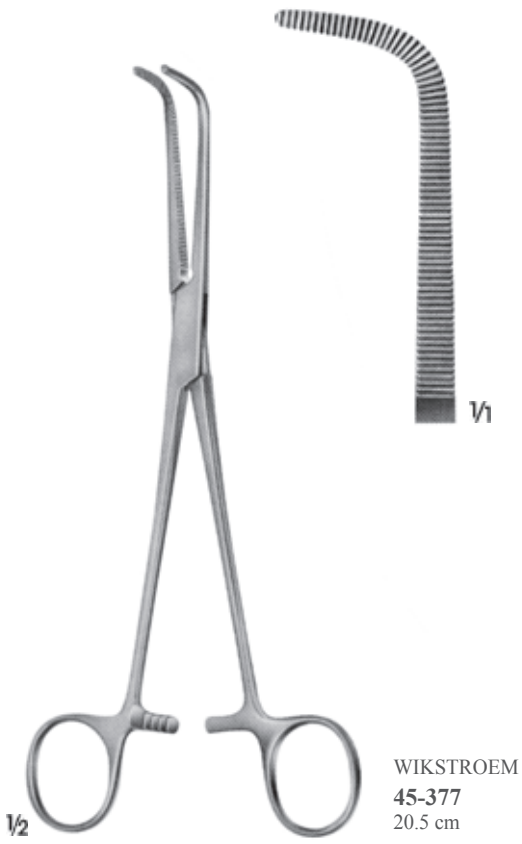
45-374  
27.5 cm



45-375  
27 cm



45-376  
28 cm





RUMEL  
24 cm

1/2



45-381



45-382



45-383



45-384



45-385

1/1



BARRE  
28 cm

45-386  
Çok hassas  
Extra delicate



45-387  
Hassas  
Delicate

1/1



KANTROWITZ

45-388  
20 cm



45-389  
24 cm



45-390  
27.5 cm

1/1



ZENKER



45-391  
30 cm



45-392  
29 cm



45-393  
35 cm



45-394  
35 cm



45-395  
35 cm

V1







LAWRENCE  
45-396  
27 cm



MIXTER  
45-397  
23 cm



45-398  
19.5 cm

PEAN



45-399  
22 cm



45-400  
23 cm

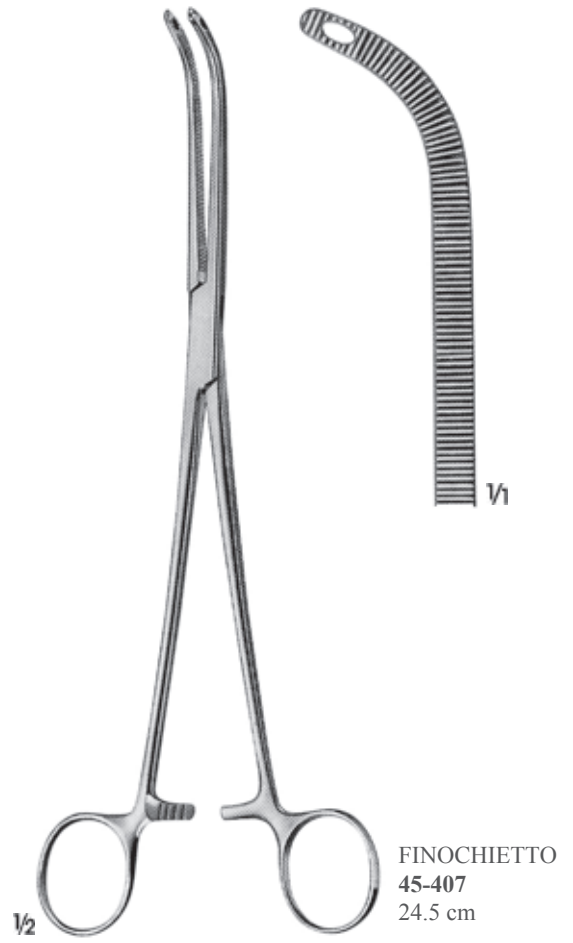
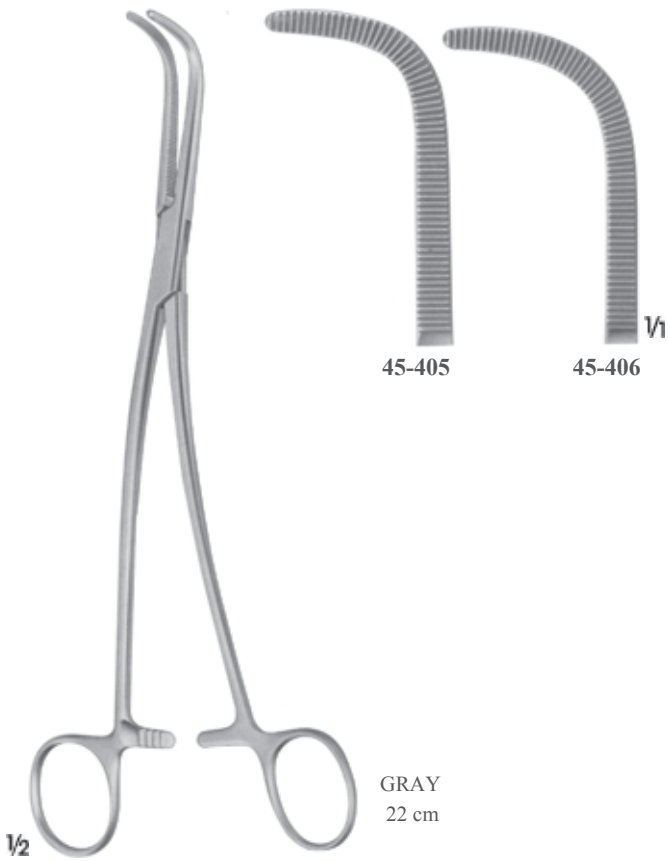
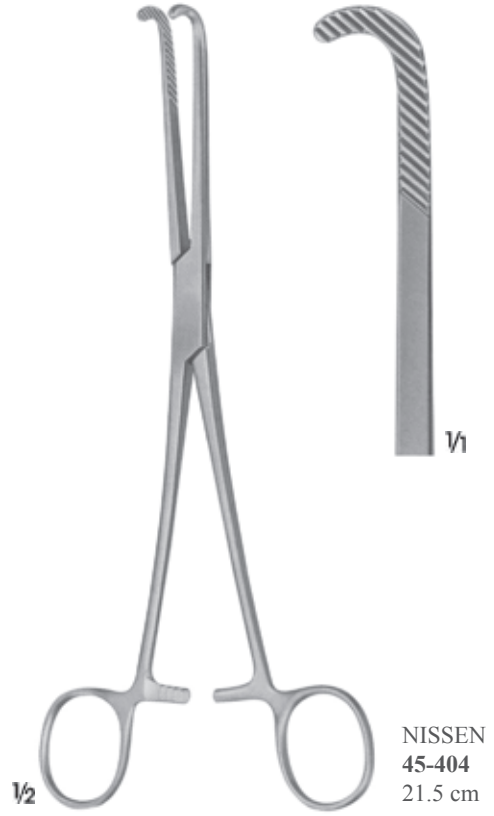
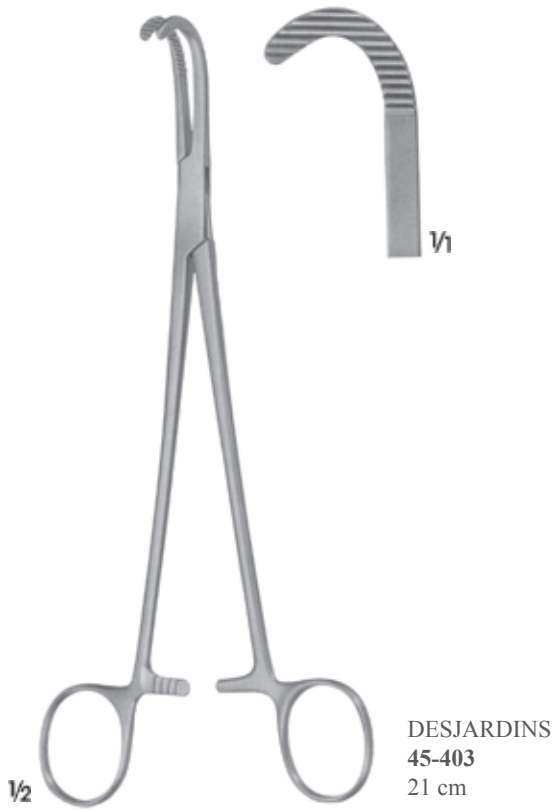


SAROT  
45-401  
25 cm



ROBERTS  
45-402  
22.5 cm







**BABY-MIKULICZ**  
**45-408**  
14 cm



**MIKULICZ**  
**45-409**  
18.5 cm



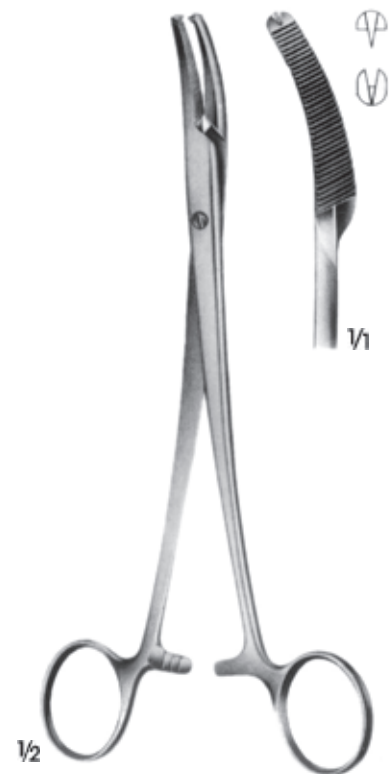
**MIKULICZ**  
**45-410 - 45-411**



**MIKULICZ**  
**45-412**  
20.5 cm

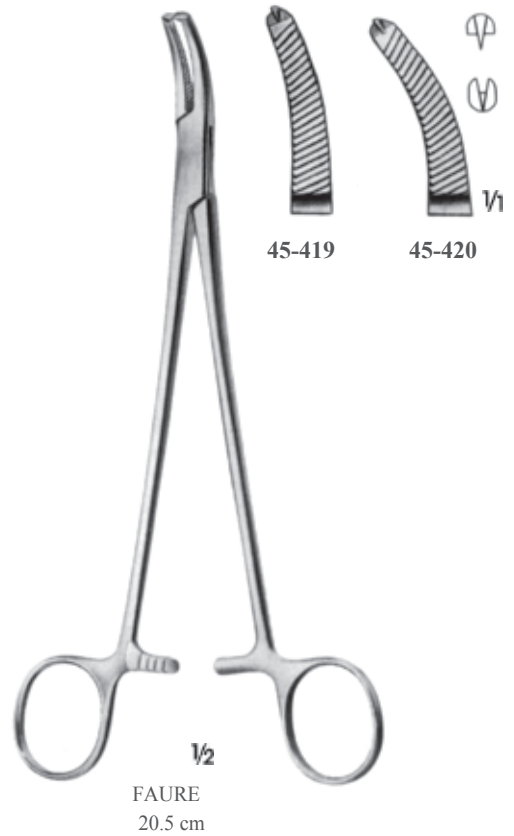


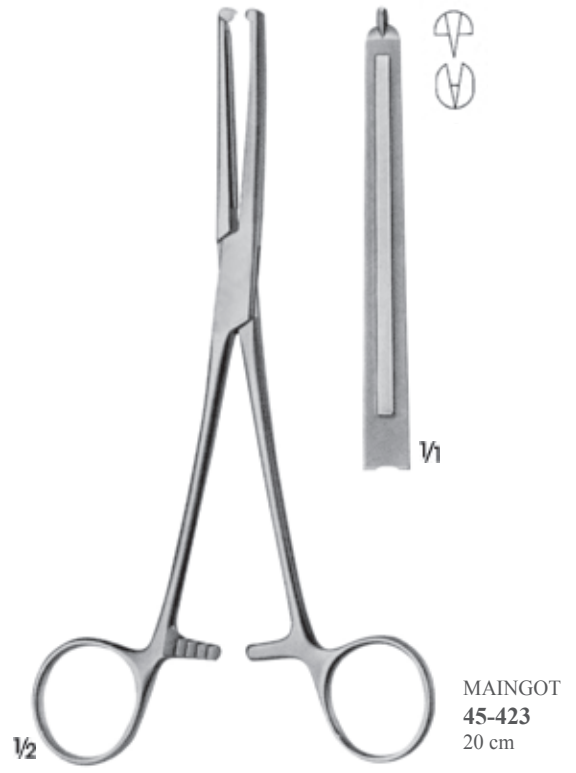
**MIKULICZ**  
**45-413**  
20.5 cm



**MIKULICZ**  
**45-414**  
20 cm







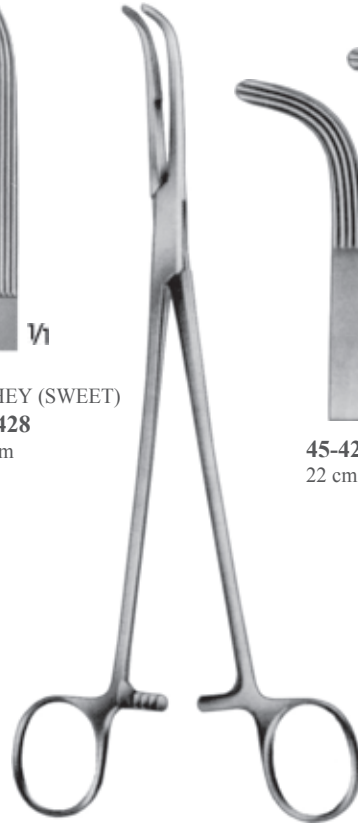


LAHEY (SWEET) LAHEY  
45-426 45-427  
20 cm 22.5 cm

LAHEY



LAHEY (SWEET)  
45-428  
23 cm



45-429  
22 cm



45-430  
25 cm

MIXTER



45-431  
29 cm



1/2

LOWER  
45-432  
18 cm



1/2



45-433  
23.5 cm



45-434  
35 cm

KEIBACK

Öne eğimli üreter kanalı  
açma klempleri  
Ureteral tunnel clamps  
curved on flat





BURKE

Parametrium pensı kısa ağız  
Parametrium clamp, short jaw part



45-435  
25 cm

45-436  
35 cm



BURKE

Parametrium pensı uzun ağız  
Parametrium clamp, long jaw part

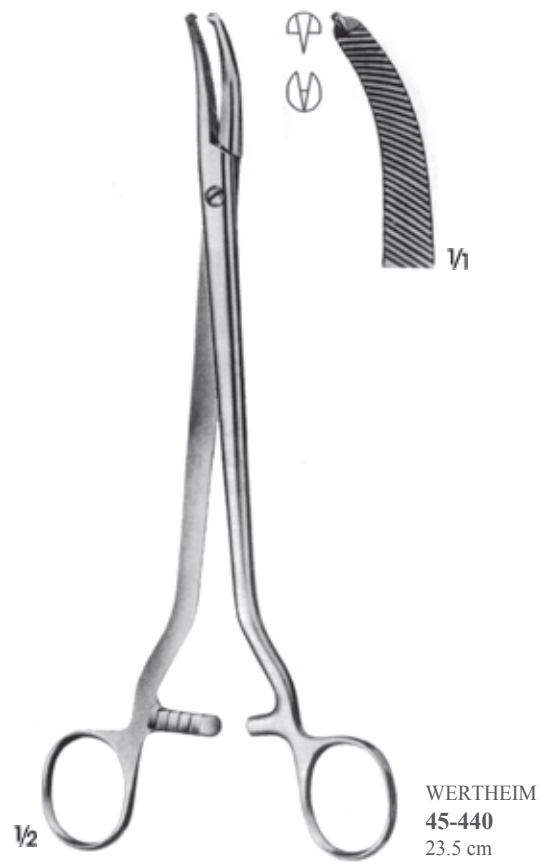


45-437  
25 cm

45-438  
35 cm









45-443  
20.5 cm

45-444  
24.5 cm

45-445  
35 cm

HEANEY



HEANEY  
45-446  
19.5 cm



45-447  
21 cm

45-448  
20.5 cm

PHANEUF



45-449  
22 cm

45-450  
24 cm

WIENER MODELL

De Bakey Diş



Toothed De BAkey



45-451  
25.5 cm

45-42  
26.5 cm

45-453  
27.5 cm

DICK



De Bakey Diş



Toothing De BAkey



KIEBACK



45-454  
25 cm



45-455  
35 cm



45-456  
25 cm



45-457  
35 cm

V1



1/2

WERTHEIM  
45-458  
25.5 cm



1/2

WERTHEIM  
45-459  
26 cm

De Bakey Diş



Toothing De BAkey



HEANEY



45-460  
22.5 cm



45-461  
22 cm



45-462  
21.5 cm



45-463  
20.5 cm



WERTHEIM



45-464  
25 cm



45-465  
24.5 cm



45-466  
24 cm



45-467  
22 cm





**45-468**  
12.5 cm

PEAN



**45-469**  
14 cm

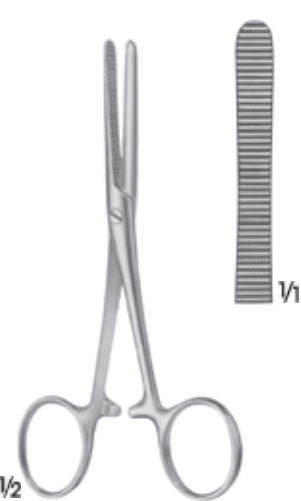


**45-470**  
16.5 cm

PEAN



**45-471**  
18.5 cm



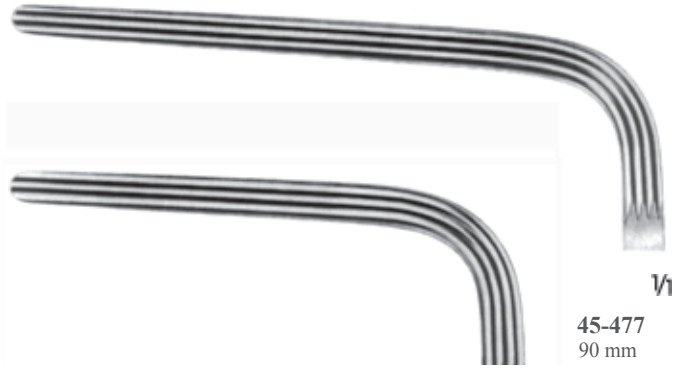
**1/2**  
**PEAN**  
**45-472**  
12.5 cm



**1/2**  
**KRÖNLEIN**  
**45-473**  
13 cm



**1/2**  
**PEAN**  
**45-474**  
12.5 cm



1/1  
45-476  
80 mm



WERTHEIM-CULLEN  
45-475  
21.5 cm



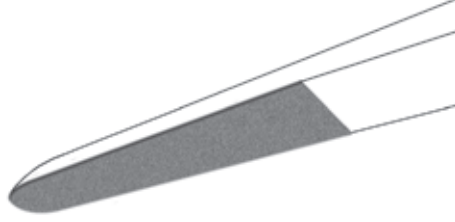
23 cm





**46-**

**DIAMOTE** ağızlar, daha sert ve aşınmaya dayanıklı yüzeyler sağlar.  
**DIAMOTE** ağızlar, hassas iğne, suture ve dokuların güvenilir bir şekilde kavranmasını garanti eder.



**DIAMOTE** jaws provide harder and more wear resistant surfaces.  
**DIAMOTE** jaws ensure reliable grip of fine needles, sutures and tissues.



Suture 5-0 ve daha küçükler için  
 For sutures 5-0 and smaller

1/2

**46-100**  
 Kilitli/Without lock  
 21 cm



**46-101 / 46-102**

1/2

**46-101 - 46-102**  
 Kilitli/With lock  
 18 cm

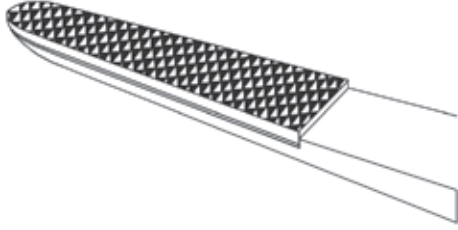


Suture 5-0 ve daha küçükler için  
 For sutures 5-0 and smaller

1/2

**46-103**  
 Kilitli/With lock  
 21 cm





**Elmas Uclu Portegüler :**

Asclass Portegülerinin ağızlarındaki elmas uclarının kullanıma göre yüzey yapısı seçilebilir.

Asclass elmas uclu portegülerinin 4 farklı yüzeyi vardır. Pürüzsüz yüzey ve 3 farklı çentik yüzeyi uygun iğne yakalamayı sağlar.

Needle holders with carbide inserts.

The carbide inserts on ASCLASS needle holders can be selected base on usage.

ASCLASS needle holders with carbide inserts have four different surface types. Smooth surface and there different notched surfaces provide appropriate needle catch.



Düz  
smooth

Pürüzsüz yüzeye sahip ağızlarda kullanılacak, dikiş malzemesi için: 9/0 - 11/0

With smooth jaw surface for suture materials: 9/0 - 11/0



0,20

0.2 mm adımlı çentiğe sahip ağızda kullanılacak, dikiş malzemesi için: 6/0 - 10/0

With 0.2 mm pitch of serration for suture material: 6 /0 - 10/0



,4

0.4 mm adımlı çentiğe sahip ağızda kullanılacak, dikiş malzemesi için: 4/0 - 6/0

0.4 mm pitch of serration for suture material: 4 /0 - 6/0



0,5

0.5 mm adımlı çentiğe sahip ağızda kullanılacak, dikiş malzemesi için: 3/0' a kadar

0.5 mm pitch of serration for suture material: up to 3/0



Düz ağız  
With smooth jaw

CASTROVIEJO  
**46-104**  
Kilitli/With lock  
14.5 cm



0,2

CASTROVIEJO  
**46-105**  
Kilitli/With lock  
14.5 cm



0,4

**46-106**  
Kilitli/With lock  
17 cm



0,2

CASTROVIEJO  
**46-107 / 46-108**  
Kilitli/With lock



0,2

**46-108**  
Kilitli/With lock  
21.5 cm



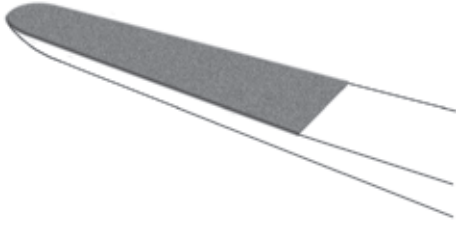
0,2

**46-109**  
Kilitli/With lock  
18 cm



0,2

**46-110**  
Kilitli/With lock  
20 cm



**DIAMOTE** ağızlar, daha sert ve aşınmaya dayanıklı yüzeyler sağlar.  
**DIAMOTE** ağızlar, hassas iğne, suture ve dokuların güvenilir bir şekilde kavranmasını garanti eder.

**DIAMOTE** jaws provide harder and more wear resistant surfaces.  
**DIAMOTE** jaws ensure reliable grip of fine needles, sutures and tissues.

Suture 5-0 ve daha küçükler için  
For sutures 5-0 and smaller



46-111  
46-112  
46-113  
46-114  
46-115  
46-116

Suture 7-0 ve daha küçükler için  
For sutures 7-0 and smaller



12 cm 46-117  
14.5 cm 46-118  
16 cm 46-119  
18.5 cm 46-120  
21 cm 46-121  
23 cm 46-122

Suture 5-0 ve daha küçükler için  
For sutures 5-0 and smaller



46-123  
46-124  
46-125  
46-126  
46-127  
46-128

Suture 7-0 ve daha küçükler için  
For sutures 7-0 and smaller



12 cm 46-129  
14.5 cm 46-130  
16 cm 46-131  
18.5 cm 46-132  
21 cm 46-133  
23 cm 46-134

Suture 4-0 ve daha küçükler için  
For sutures 4-0 and smaller



46-135  
46-136  
46-137  
46-138  
46-139  
46-140

Suture 4-0 ve daha küçükler için  
For sutures 4-0 and smaller

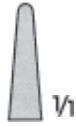


46-141  
46-142  
46-143  
46-144  
46-145  
46-146

46-111 - 46-122  
Kilitsiz/Without lock

46-123 - 46-146  
Kilitli/With lock

Suture 2-0 ve daha küçükler için  
For sutures 2-0 and smaller



19 cm 46-147  
23 cm 46-148  
25 cm 46-149

46-147 - 46-149  
Kilitli/With lock

Suture 2-0 ve daha küçükler için  
For sutures 2-0 and smaller



19 cm 46-150  
23 cm 46-151  
25 cm 46-152

46-150 - 46-152  
Kilitsiz/Without lock

Düz Sap/Flat Handle

Sütür 7-0 ve daha küçükler için  
For sutures 7-0 and smaller



14.5 cm **46-153**  
17 cm **46-154**  
18.5 cm **46-155**  
21 cm **46-156**  
23 cm **46-157**

**46-153 - 46-162**  
Kilitsiz/Without lock

Sütür 5-0 ve daha küçükler için  
For sutures 5-0 and smaller



14.5 mm **46-158**  
17 cm **46-159**  
18.5 cm **46-160**  
21 cm **46-161**  
23 cm **46-162**

Sütür 7-0 ve daha küçükler için  
For sutures 7-0 and smaller



14.5 mm **46-163**  
17 cm **46-164**  
18.5 cm **46-165**  
21 cm **46-166**  
23 cm **46-167**

**46-163 - 46-172**  
Kilitli/With lock

Sütür 5-0 ve daha küçükler için  
For sutures 5-0 and smaller



14.5 mm **46-168**  
17 cm **46-169**  
18.5 cm **46-170**  
21 cm **46-171**  
23 cm **46-172**

Kanallı Düz Sap/Flat Knurled Handle

Sütür 5-0 ve daha küçükler için  
For sutures 5-0 and smaller



18.5 cm **46-173**  
21 cm **46-174**  
23 cm **46-175**

**46-173 - 46-175**  
Kilitsiz/Without lock

Sütür 5-0 ve daha küçükler için  
For sutures 5-0 and smaller



18.5 cm **46-176**  
21 cm **46-177**  
23 cm **46-178**

**46-176 - 46-178**  
Kilitli/With lock



**Yuvarlak Saplar**  
Parmaklar arasında istenildiği şekilde döndürmeye izin verir.  
Sağlam veya oyulmuş saplardan dolayı her bir alette optimum denge sağlar

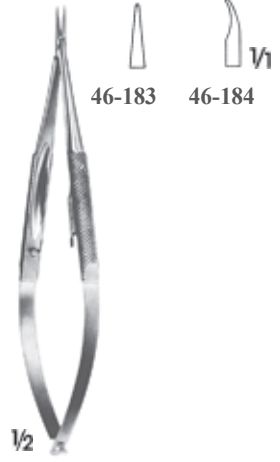
**Round Handle**  
Allows rotation between the fingers as required  
Due to carved and strong handle, each instrument provides optimum balance



**BARRAQUER**  
Kilitsiz/Without lock



**BARRAQUER**  
Kilitsiz/Without lock  
12 cm



**BARRAQUER**  
Kilitli/With lock  
12 cm



**Kilitli/With lock**  
15 cm



**REILL**  
Kilitsiz/Without lock  
15 cm

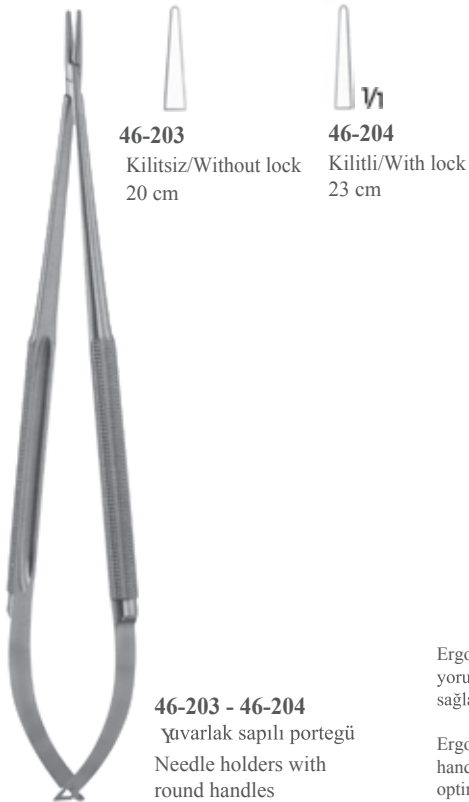
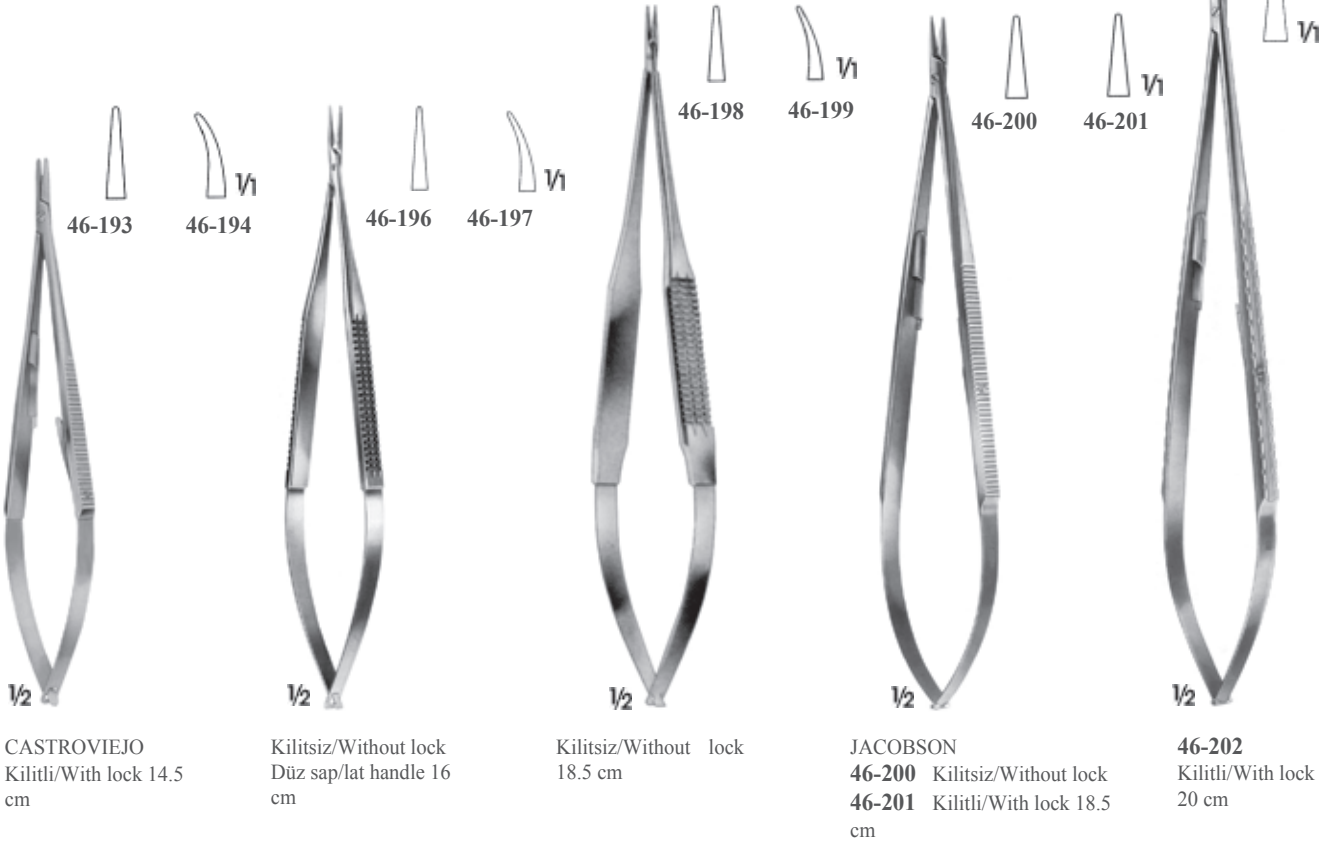


**Kilitsiz/Without lock**  
18.5 cm



**Kilitli/ With catch**  
18.5 cm

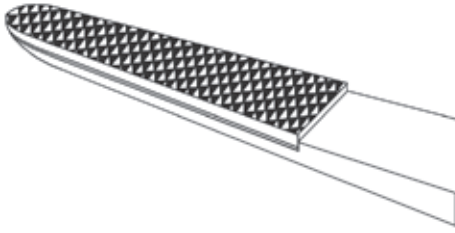
Düz Saplar/Flat Handles



Ergonomik, hafif plastik sap yorulmadan optimum kullanım sağlar.

Ergonomic, light weight plastic handle provides fatigue free, optimal usage.





**Elmas Uclu Portegüler :**

Asclass Portegülerinin ağızlarındaki elmas uclarının kullanıma göre yüzey yapısı seçilebilir.

Bahadır elmas uclu portegülerinin 4 farklı yüzeyi vardır. Pürüzsüz yüzey ve 3 farklı çentik yüzeyi uygun iğne yakalamayı sağlar.

Needle holders with carbide inserts.

The carbide inserts on ASCLASS needle holders can be selected based on usage.

ASCLASS needle holders with carbide inserts have four different surface types. Smooth surface and three different notched surfaces provide appropriate needle catch.



Düz  
smooth

Pürüzsüz yüzeye sahip ağızlarda kullanılacak, dikiş malzemesi için: 9/0 - 11/0

With smooth jaw surface for suture materials: 9/0 - 11/0



0,20

0.2 mm adımlı çentiğe sahip ağızda kullanılacak, dikiş malzemesi için: 6/0 - 10/0

With 0.2 mm pitch of serration for suture material: 6/0 - 10/0



,4

0.4 mm adımlı çentiğe sahip ağızda kullanılacak, dikiş malzemesi için: 4/0 - 6/0

0.4 mm pitch of serration for suture material: 4/0 - 6/0



0,5

0.5 mm adımlı çentiğe sahip ağızda kullanılacak, dikiş malzemesi için: 3/0' a kadar

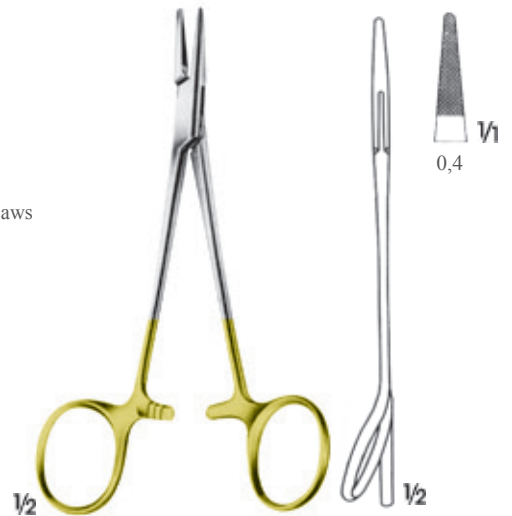
0.5 mm pitch of serration for suture material: up to 3/0



HALSEY  
46-205  
12 cm

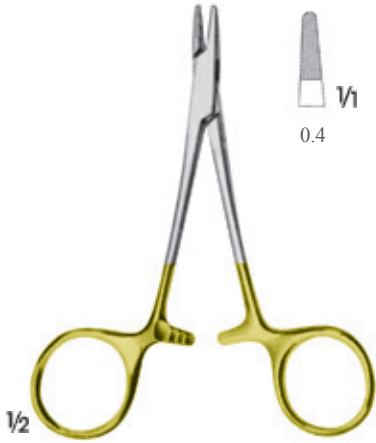


WEBSTER  
46-206  
12.5 cm

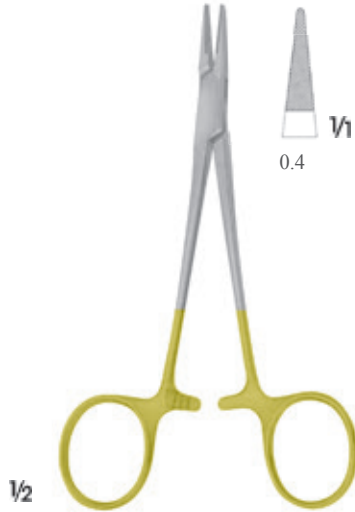


MASING  
46-207  
Tek ayağı açılı, yüzüklü  
One ring angled  
13 cm

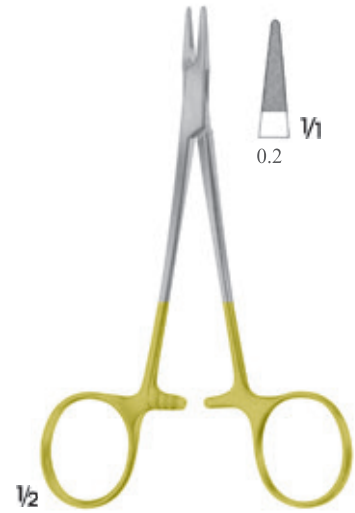




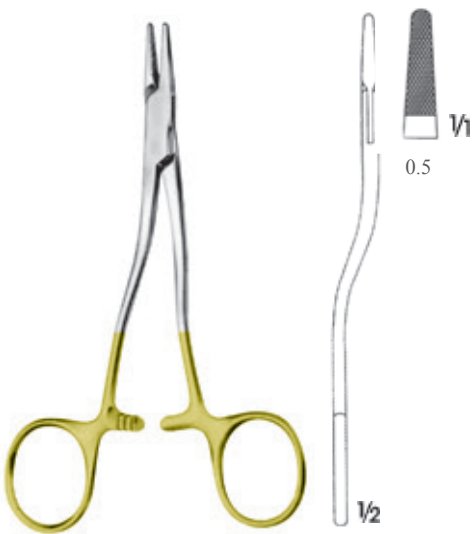
DERF  
46-208  
11.5 cm



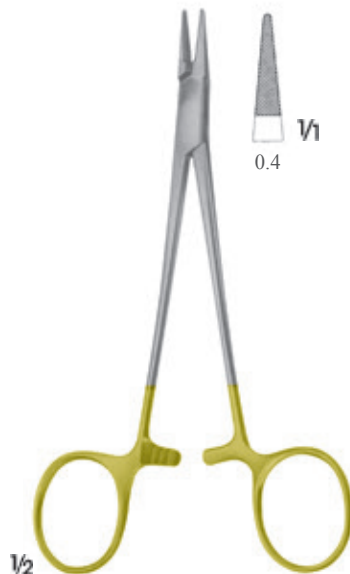
HALSEY  
46-209  
13 cm



CONVERSE  
46-210  
13 cm



KILNER  
46-211  
13.5 cm









BABY-CRILE-WOOD  
46-212  
15 cm



BAUMGARTNER  
46-213  
14.5 cm





HEGAR-MAYO  
 46-214 - 46-219

					
0.50	.5	0.50	0.50	.5	.5
<b>46-214</b>	<b>46-215</b>	<b>46-216</b>	<b>46-217</b>	<b>46-218</b>	<b>46-219</b>
15 cm	18.5 cm	20.5 cm	23.5 cm	26.5 cm	30 cm








HEGAR

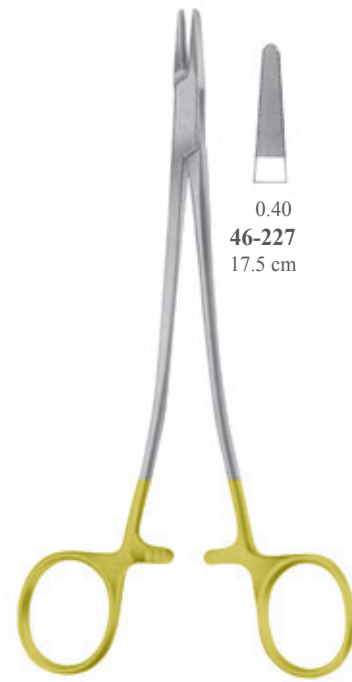
	
0,50	,5
<b>46-220</b>	<b>46-221</b>
20.5 cm	24.5 cm







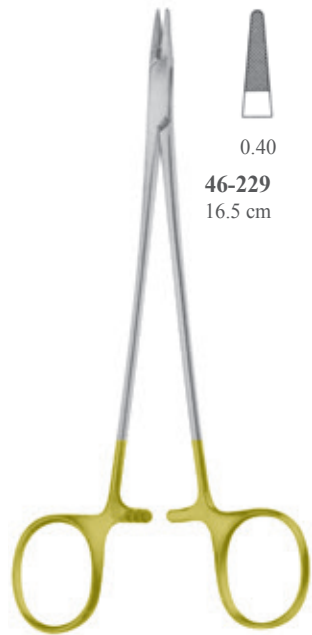
CRILE-WOOD

				
0.4	0.4	0.4	0.4	0.4 $\nabla$
<b>46-222</b>	<b>46-223</b>	<b>46-224</b>	<b>46-225</b>	<b>46-226</b>
14.5 cm	18.5 cm	20 cm	27 cm	30.5 cm







SAROT

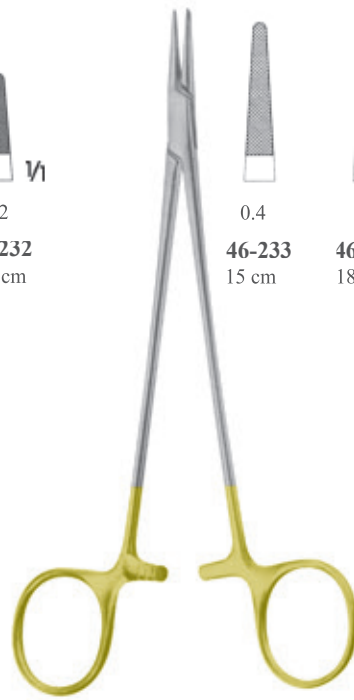
	
0.40	.4 $\nabla$
<b>46-227</b>	<b>46-228</b>
17.5 cm	26 cm



DE BAKEY  
 Çok hassas/Very delicate






*FineCut*

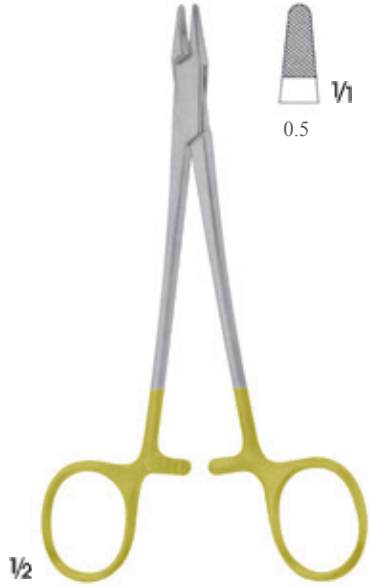
			
0.40	0.4	0.2	.2 $\nabla$
<b>46-229</b>	<b>46-230</b>	<b>46-231</b>	<b>46-232</b>
16.5 cm	21 cm	16.5 cm	21 cm



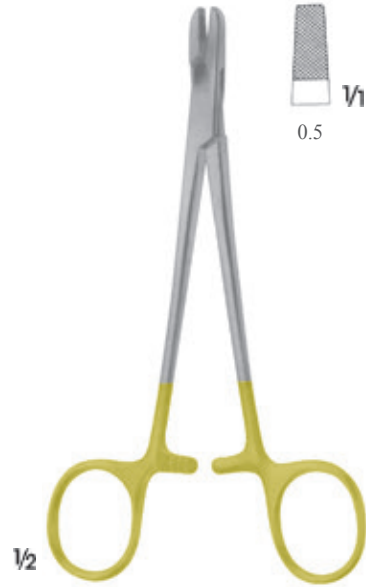
DE BAKEY

*FineCut*

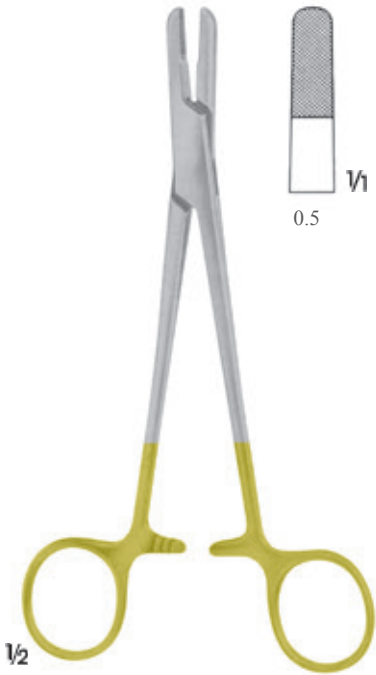
				
0.4	0.4	0.40	.4	0.4 $\nabla$
<b>46-233</b>	<b>46-234</b>	<b>46-235</b>	<b>46-236</b>	<b>46-237</b>
15 cm	18 cm	23 cm	25 cm	30.5 cm



**46-238**  
 Tel bükücü /Wire twister  
 15 cm



**46-239**  
 Tel bükücü /Wire twister  
 15 cm



**46-240**  
 Tel Bükücü/ Wire twister  
 Sternum suture için ligatür pens  
 Sternum suture for ligature forceps  
 17.5 cm

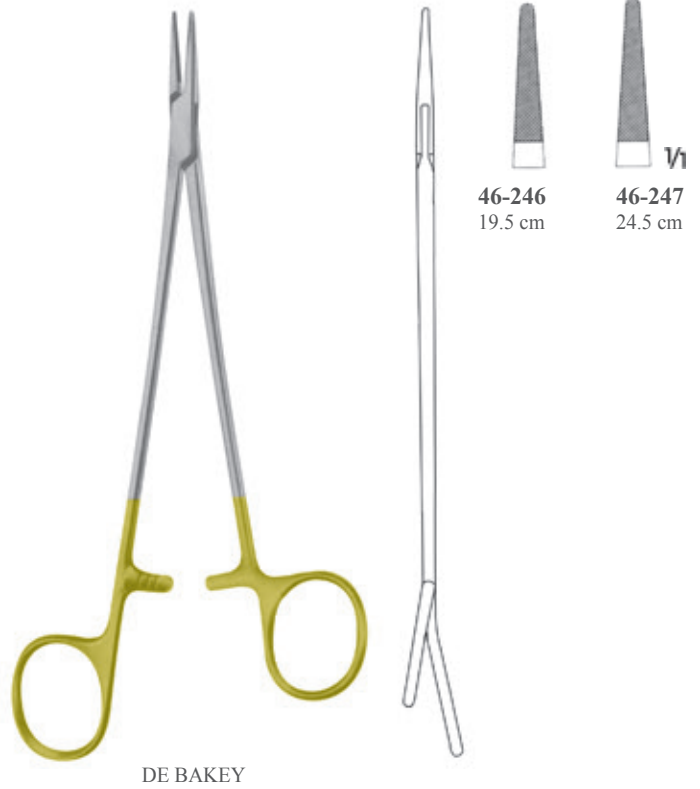
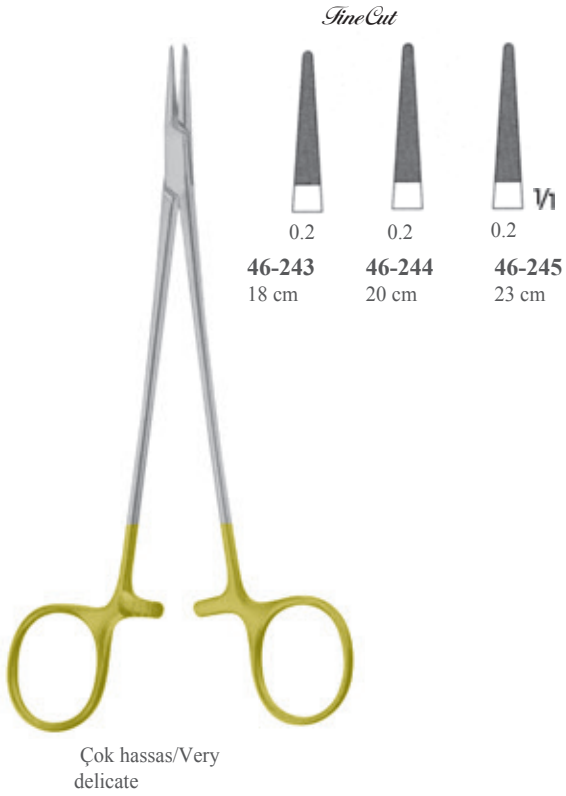


**BERRY**  
**46-241**  
 Tel bükücü /Wire twister  
 Ligatür pens/Ligature forceps  
 18.5 cm



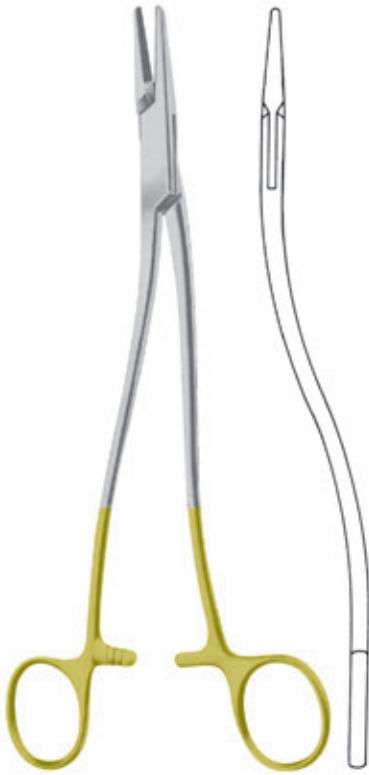
**BAUMGARTNER**  
**46-242**  
 Tel bükücü /Wire twister  
 Ligatür pens/Ligature forceps  
 20 cm





Uzatılmış bir sap ve kavisli yüzükler, optimum tutuş sağlar.  
One extended handle and curved rings ensure optimum grip





WERTHEIM



0.50  
**46-250**  
20 cm



.5  
**46-251**  
24 cm



0.5  
**46-252**  
30 cm



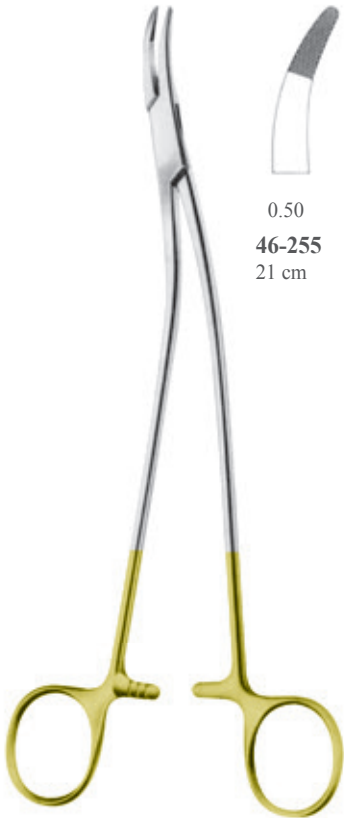
HEANEY



0.5  
**46-253**  
20 cm



0.5  
**46-254**  
26 cm



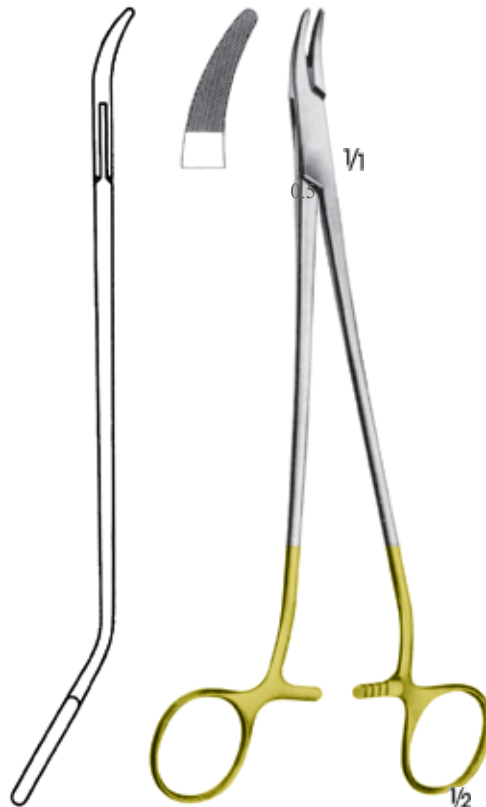
STRATTE



0.50  
**46-255**  
21 cm



.5  
**46-256**  
23 cm



**46-257**  
S şekli portegü/S-shaped needle  
21.5 cm



0.5  
**46-257**



$\frac{1}{2}$   
**FINOCHIETTO**  
**46-258**  
26.5 cm



$\frac{1}{2}$   
**NAUNTON-MORGAN**  
**46-259**  
26 cm



$\frac{1}{2}$   
**MÜLLER**  
**46-260**  
Derin rektum cerrahisi için  
For deep rectum surgery  
36 cm

- Cerraha maksimum ergonomik rahatlık sağlar.
- Optimize tasarımları sayesinde zor sütur ve anastomoz tekniklerinde yorulmadan çalışmayı sağlar.
- Provides maximum ergonomic comfort to surgeon.
- Due to optimized design, it provides fatigue free working on suture and anastomosis techniques.



**REIN-KUPKA**  
**46-261**  
 Kilitliiz/Without ratchet lock  
 19 cm



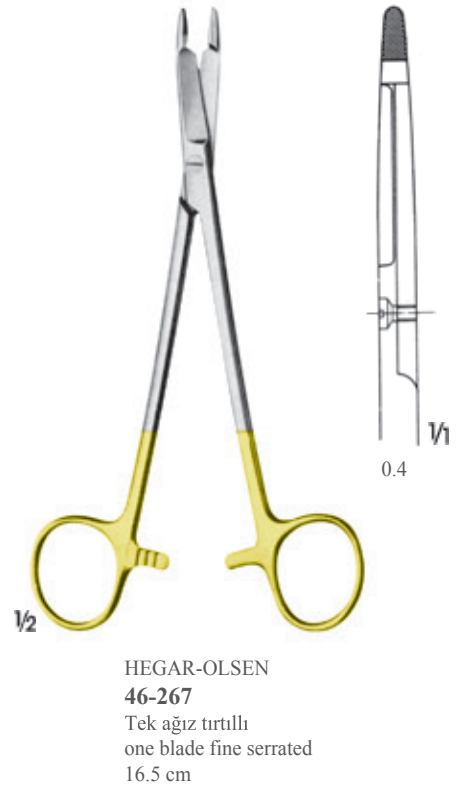
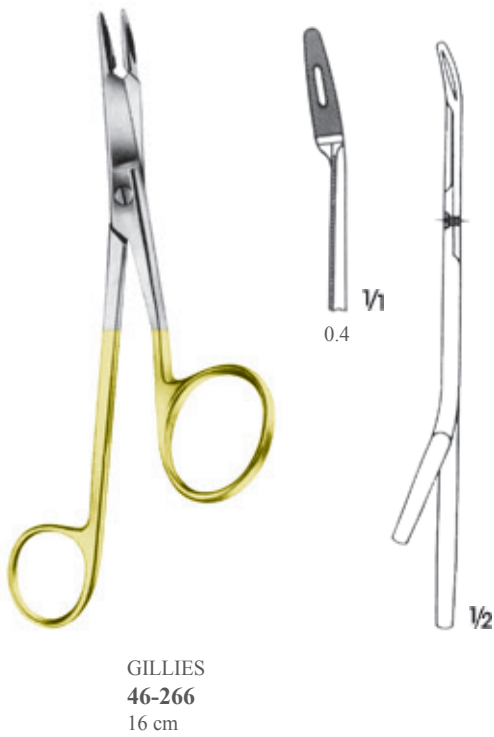
**REIN-KUPKA**  
**46-262**  
 Kilitli/ With ratchet lock  
 19 cm



**HELLBERG-KUPKA**  
**46-263**  
 Kilitli/ With ratchet lock  
 21 cm







- Hassas çeneler travmatik olmayan ve hassas damar iğnelerini tutmak için uygundur.

- Fine jaws are suitable for gripping non-traumatic needles and vein needles.

*Fine Cut*



RYDER  
Çok hassas/Very delicate



0.2

**46-268**  
13.5 cm



0.2

**46-269**  
15.5 cm



0.2

**46-270**  
17.5 cm



0.2

**46-271**  
21 cm



0.2

**46-272**  
23 cm



RYDER



0.4

**46-273**  
13.5 cm



0.4

**46-274**  
17.5 cm



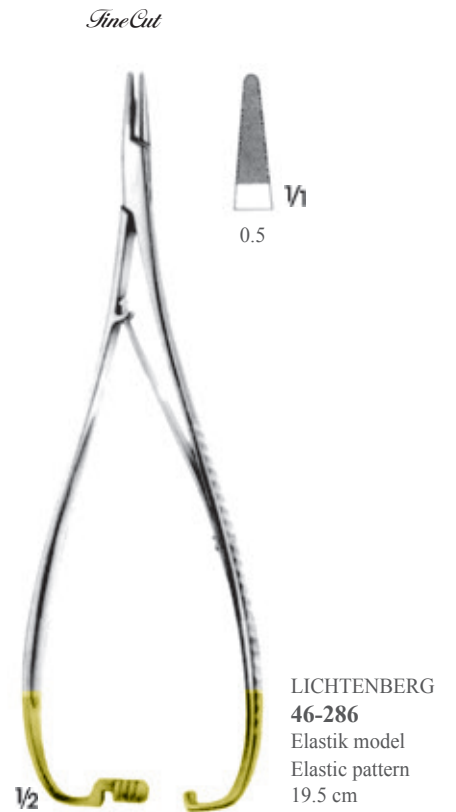
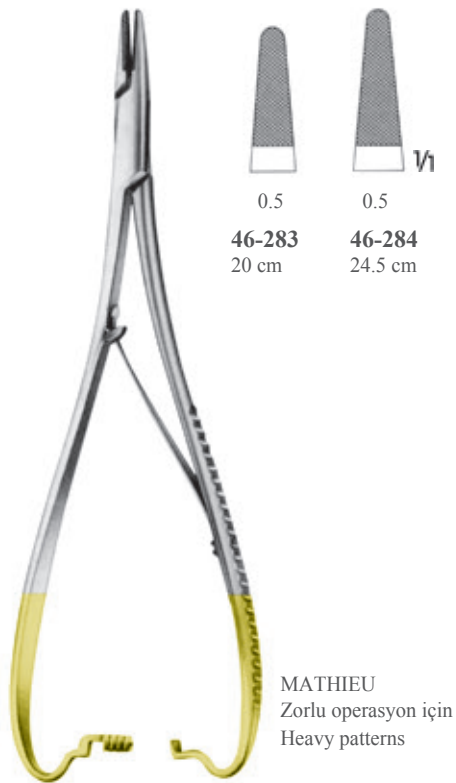
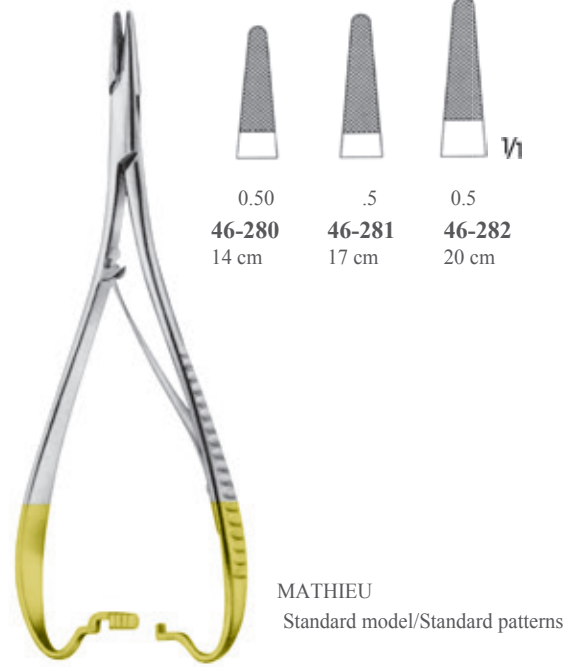
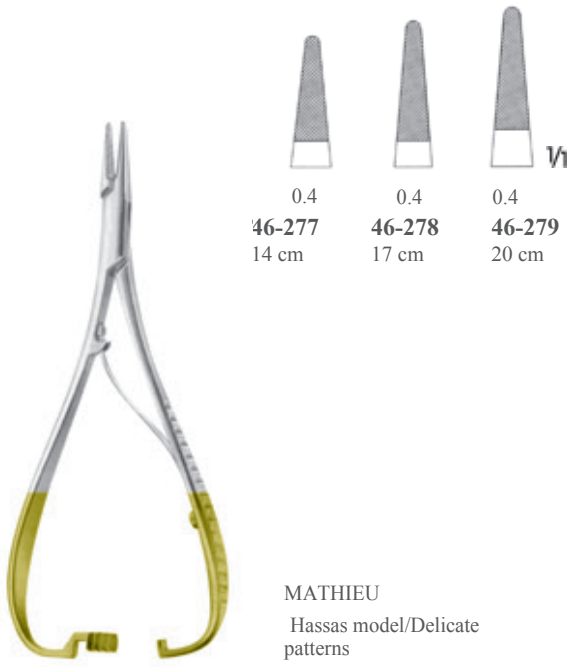
0.4

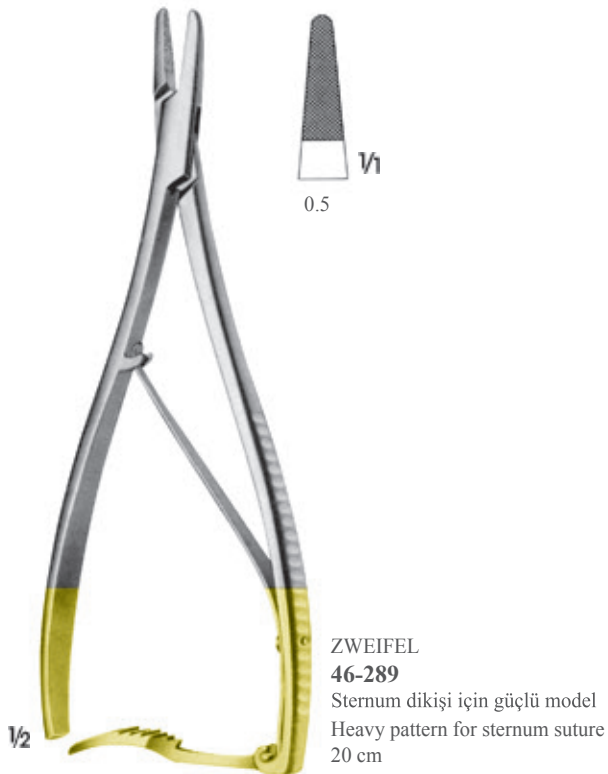
**46-275**  
19.5 cm



0.4

**46-276**  
26.5 cm







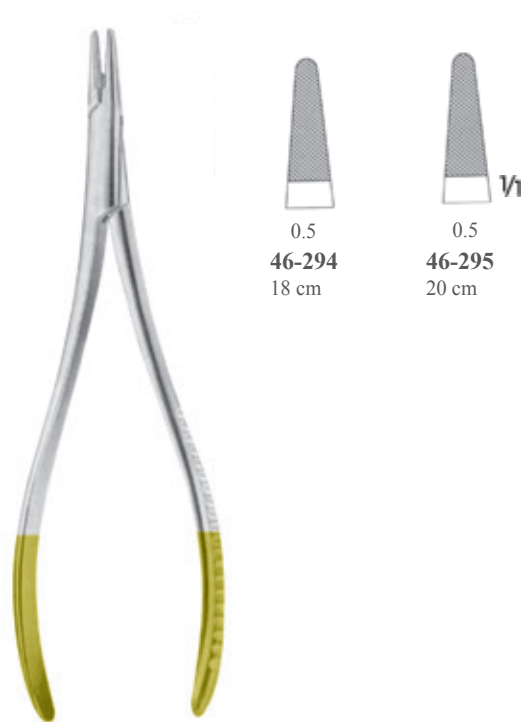
TÖNNIS  
**46-291**  
 Elastik model/Elastic pattern  
 18 cm



TÖNNIS  
**46-292**  
 Elastik model/Elastic pattern  
 18 cm



LANGENBECK  
**46-293**  
 Elastik model/Elastic pattern  
 20 cm



LANGENBECK



46-296



15 cm



J

46-297  
18 cm



46-298  
23 cm



V1

RYDER

Düz ağız/With smooth jaws



0.4

V1

1/2

46-299  
18 cm



0.4

V1

1/2

46-300  
20 cm





MASSON  
46-301  
26.5 cm



WANGENSTEEN  
46-302  
27.5 cm





**46-303**  
Düz ağız  
Smooth jaws



Düz ağız  
Smooth jaw



**DERF**  
**46-307**  
12.5 cm



**BAUMGARTNER**  
**46-308**  
14.5 cm



**LAWRANCE**  
**46-309**  
15 cm





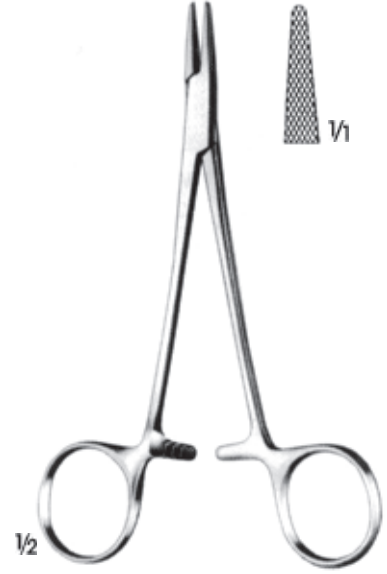
Hassas operasyon için  
Delicate pattern

CRILE-WOOD  
46-310  
15 cm

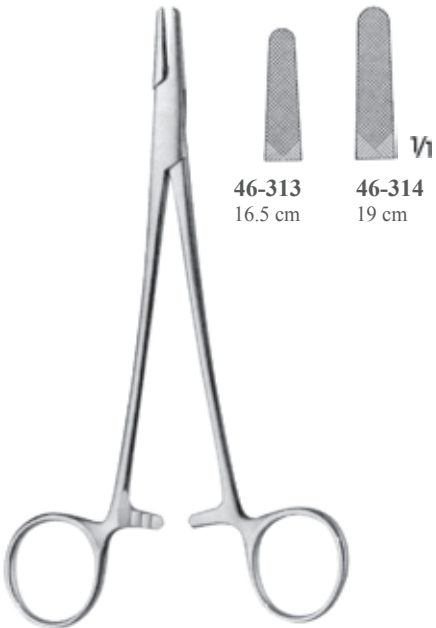


Zorlu operasyon için  
Heavy pattern

CRILE-WOOD  
46-311  
16 cm



CRILE-MURRAY  
46-312  
15 cm



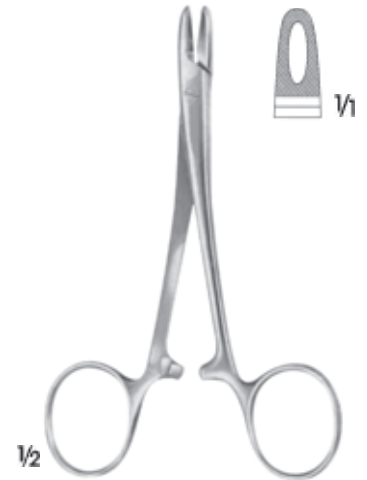
46-313  
16.5 cm

46-314  
19 cm

MAYO-HEGAR



KILNER  
46-315  
13.5 cm



DOYEN  
46-316  
12.5 cm





HEGAR  
T16-212 - T16-215  
Zorlu operasyon için  
Heavy patterns



MAYO-HEGAR  
T16-216 - T16-220  
Orta incelikte dikiş pensi  
Medium fine patterns



ADSON  
46-326  
17.5 cm

Ön ve damak için dikiş pensi  
Designed for frontal and palate  
suture



HEANEY  
46-327  
20 cm



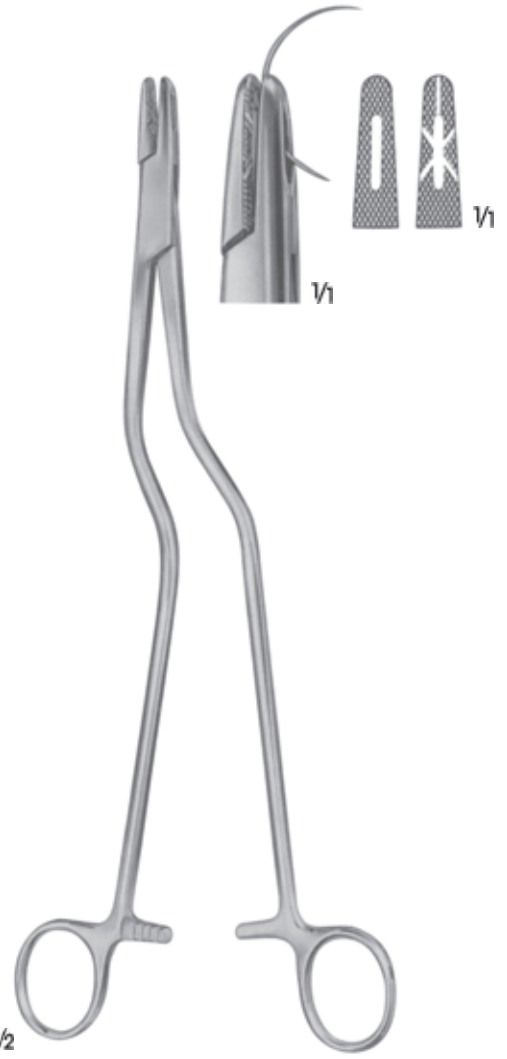
JAMESON  
46-328  
23 cm



MASSON  
46-329  
26.5 cm

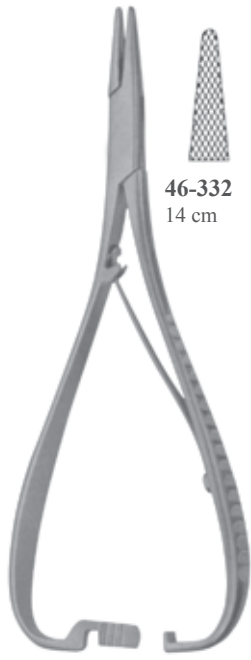


WANGENSTEEN  
46-330  
27.5 cm



MASSON-LUETHY  
46-331  
25.5 cm





MATHIEU

46-332  
14 cm

46-333  
17 cm

46-334  
20 cm

1/1



MATHIEU-STILLE  
Çok zorlu operasyon için  
Very heavy patterns

46-335

46-336

17.5 cm

20 cm

1/1



1/2

CRILE  
46-337  
15 cm



1/1



1/2

TÖNNIS  
46-338  
Dura ve bağırsak dikiş pens  
Elastic pattern for dura-or intestinal suture  
18 cm



1/1



HEGAR-OLSEN



46-339  
14 cm



46-340  
18.5 cm



GILLIES  
46-341  
15 cm



1/2  
1/1

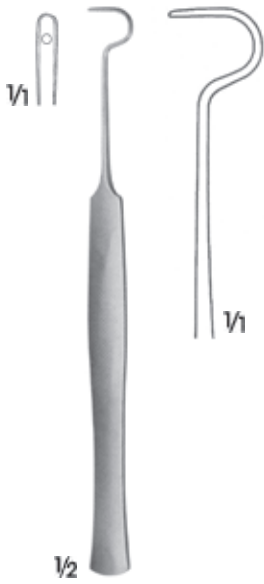


GILLIES  
46-342  
16 cm



1/2  
1/1





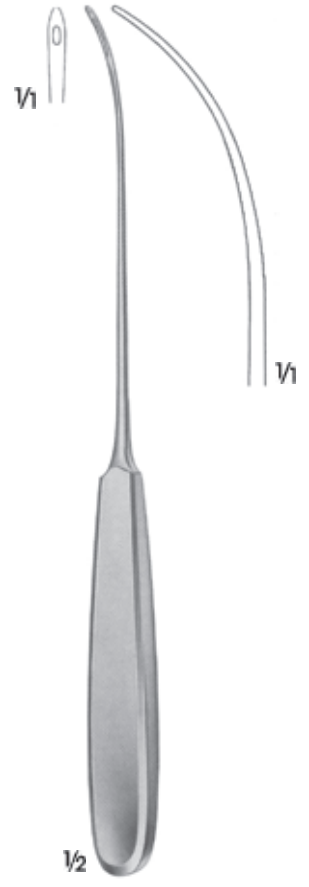
1/2  
**46-343**  
15 cm



1/2  
**SYME**  
**46-344**  
17 cm



1/2  
**JONESCO**  
**46-345**  
Dikiş teli Klavuzu  
Needle for wire suture  
18.5 cm



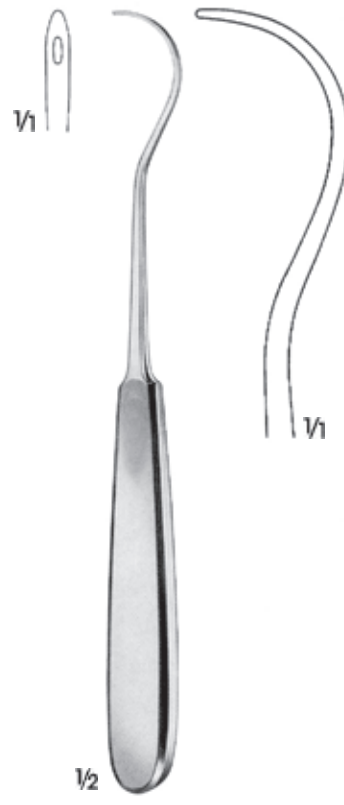
1/2  
**46-346**  
Bükülebilir/  
Malleable 23 cm



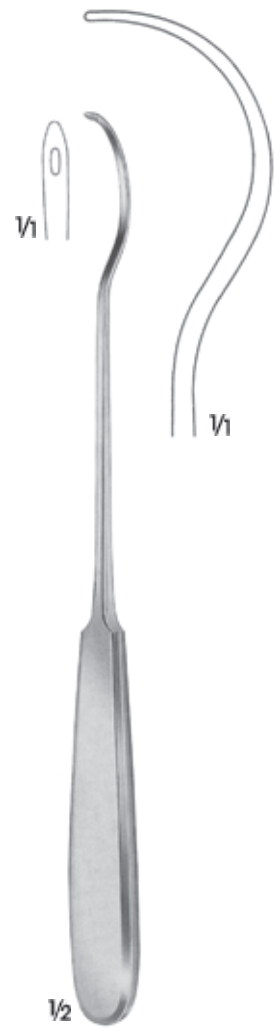
1/2  
CLAUS VAN EICKEN  
46-347  
25 cm



1/2  
COOPER  
46-348  
20.5 cm



1/2  
KOCHER  
46-349  
20.5 cm

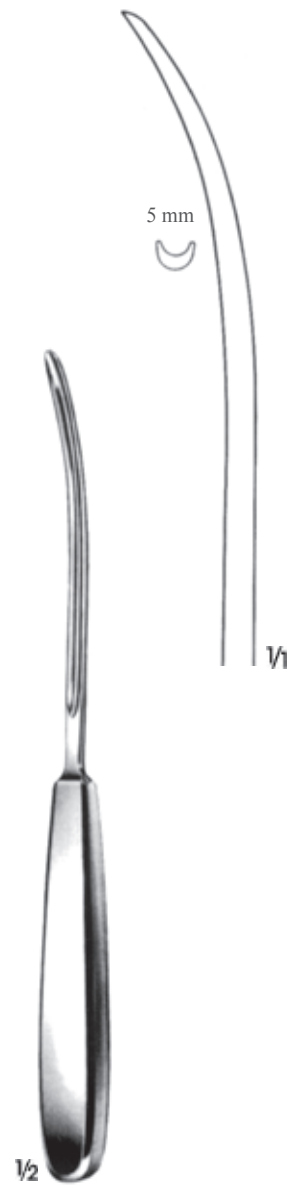


1/2  
BRUNNER  
46-350  
24 cm





PAYR  
46-351  
19.5 cm



PAYR  
46-352  
22.5 cm

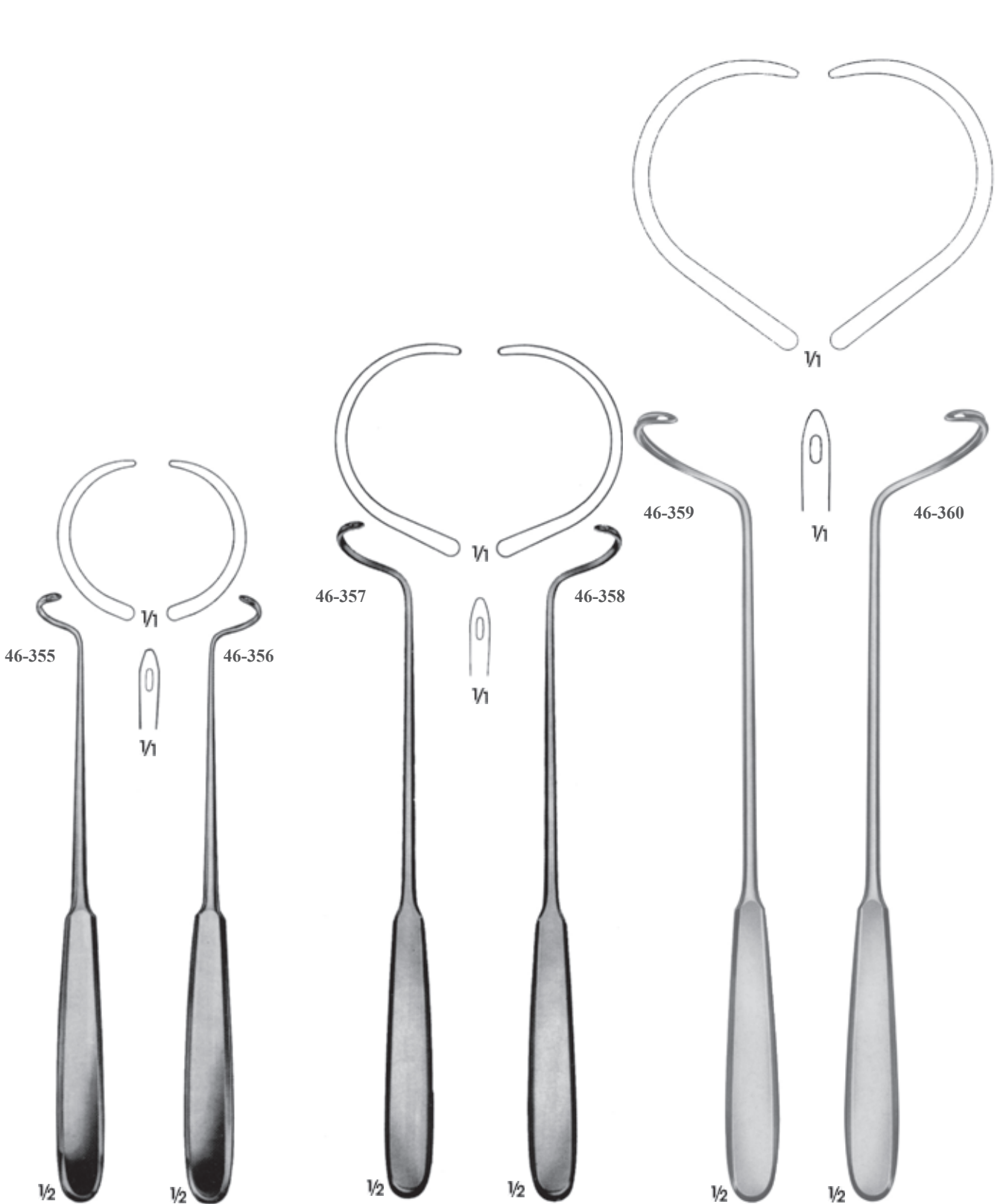


KOCHER  
46-353  
15 cm



KOCHER  
46-354  
17 cm





DESCHAMPS

Sağ el için, künt  
For right hand blunt

Sol el için, künt  
For left hand blunt  
21.5 cm

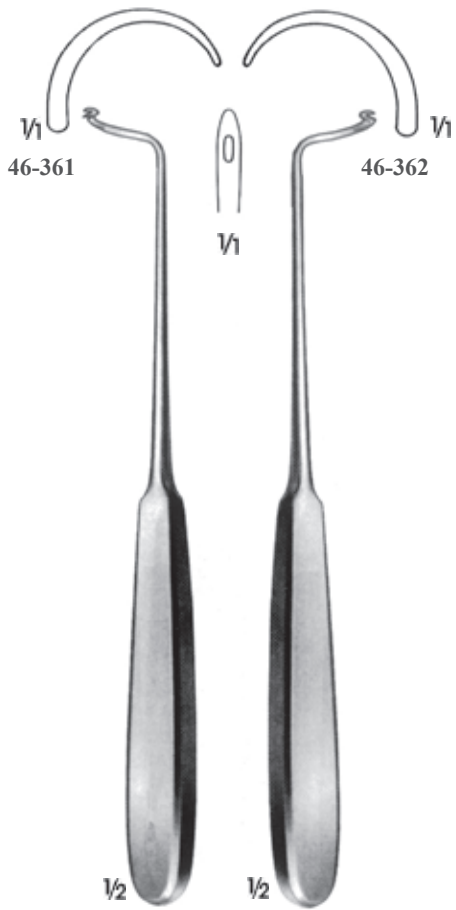
DESCHAMPS

Sağ el için, künt  
For right hand blunt

Sol el için, künt  
For left hand blunt  
24 cm

DESCHAMPS

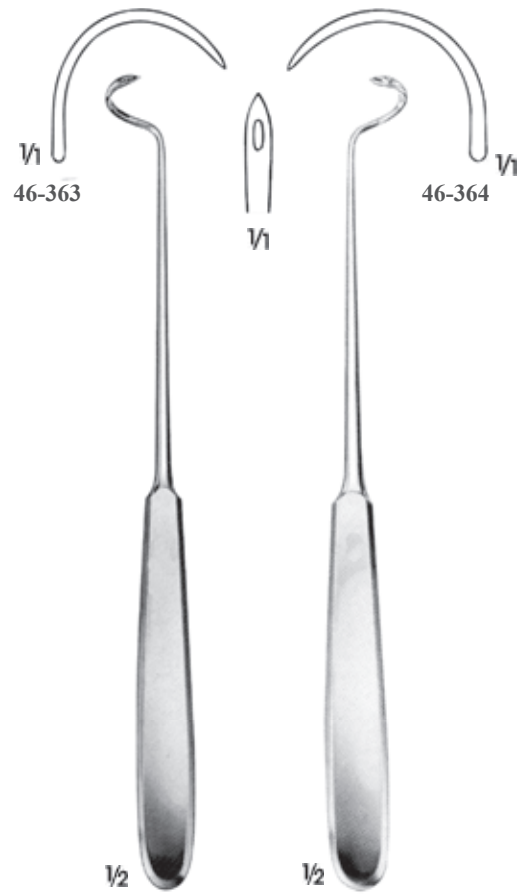
Sağ el için, künt  
For right hand blunt  
Sol el için, künt  
For left hand blunt 28  
cm



DESCHAMPS

Sağ el için, künt  
For right hand blunt

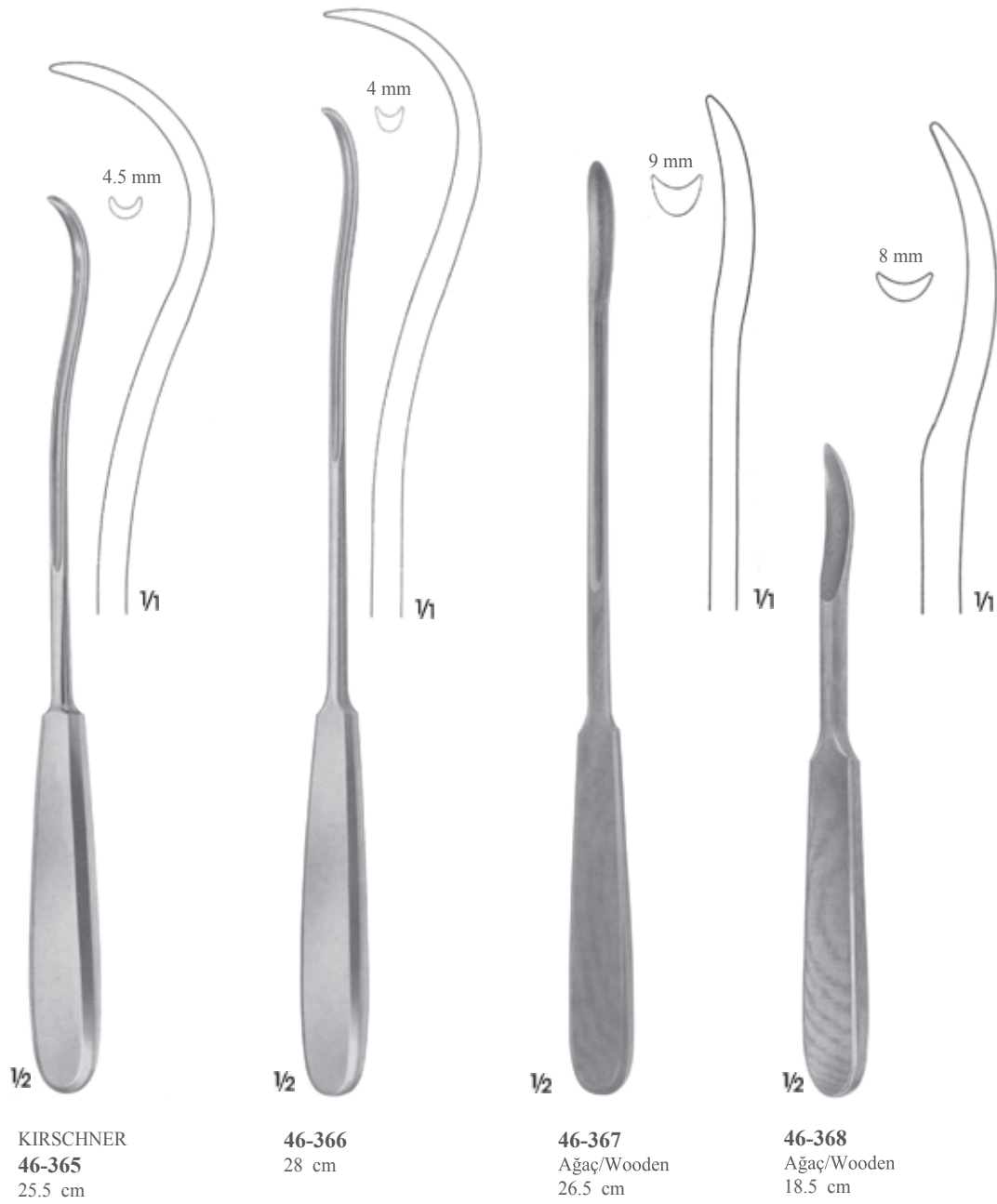
Sol el için, künt  
For left hand blunt  
21 cm



DESCHAMPS

Sağ el için, künt  
For right hand blunt

Sol el için, künt  
For left hand blunt  
21.5 cm





DESCHAMPS

Sağ el için, sivri  
For right hand sharp

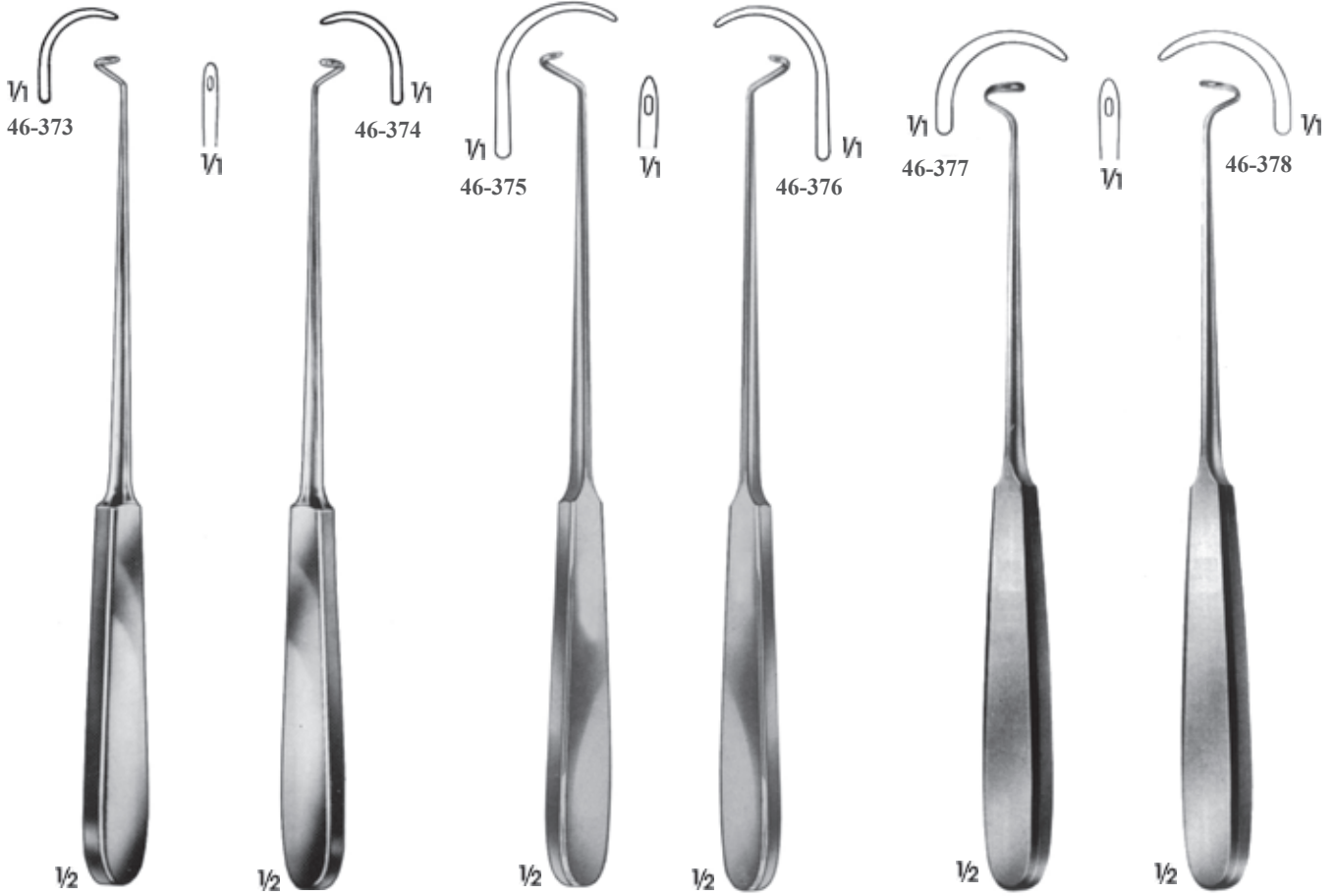
Sol el için, künt For  
left hand sharp 21  
cm



HURD

Sağ el için, sivri  
For right hand sharp

Sol el için, künt  
For left hand sharp  
21 cm



DESCHAMPS

Sağ el için, künt  
For right hand blunt

Sol el için, künt  
For left hand blunt  
22.5 cm

DESCHAMPS

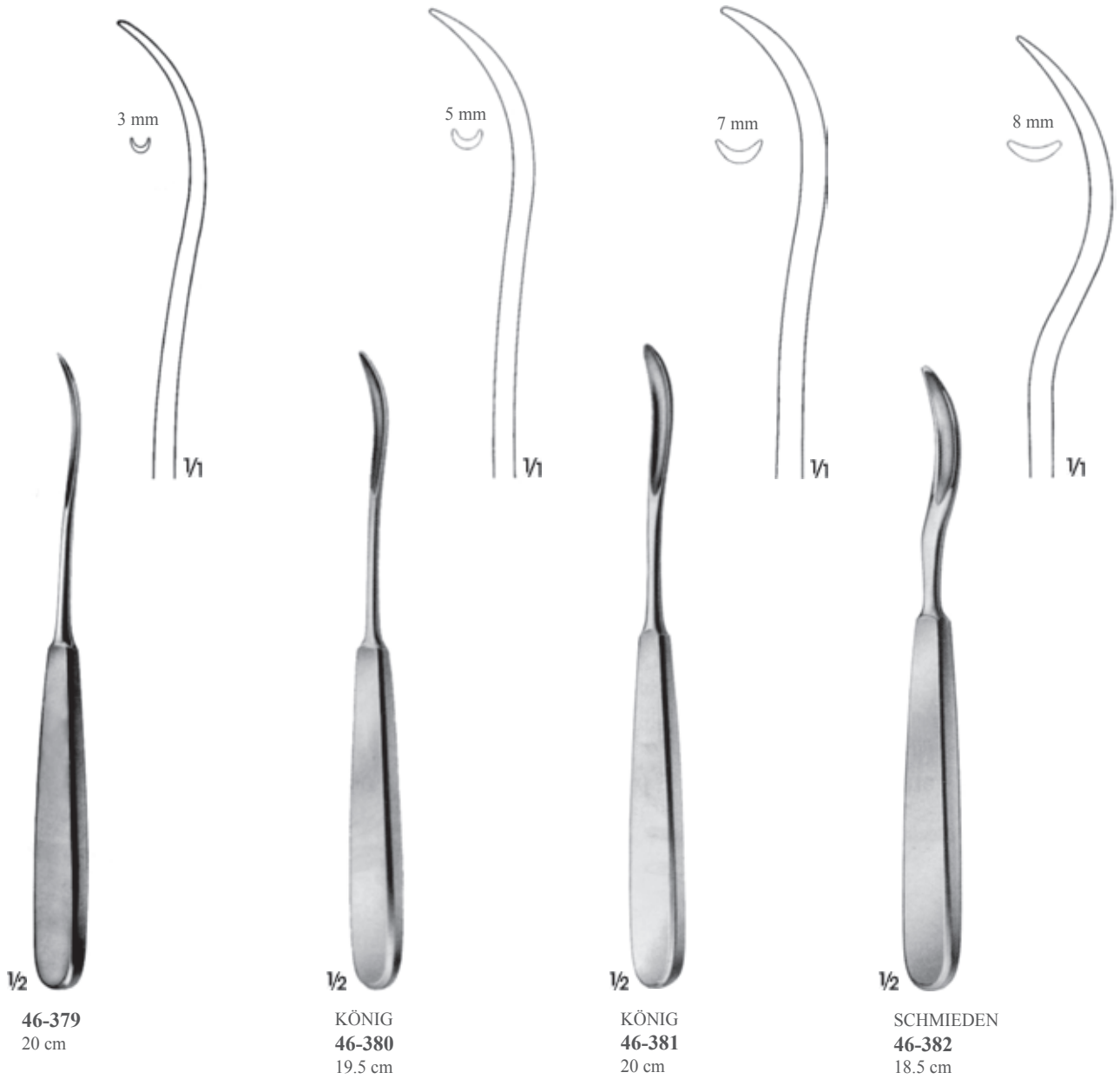
Sağ el için, künt  
For right hand blunt

Sol el için, künt  
For left hand blunt  
22.5 cm

DESCHAMPS

Sağ el için, künt  
For right hand blunt

Sol el için, künt  
For left hand blunt  
21.5 cm





**1/2**  
YOUNG-HRYNTSCHAK  
**46-383**  
1 iğne ile T16-306  
With 1 needle T16-306 24  
cm



**1/1**  
**46-384**



**1/1**  
**46-385**



**1/1**  
**46-386**



**1/2**  
MILLIN  
**46-387**  
Ligatur tutucu pens  
Ligature holding forceps  
28.5 cm



**1/2**  
MICHEL  
46-388  
Klip uygulayıcı ve çıkarıcı pens  
Clip applying and removing forcep  
12.5 cm



**1/2**  
MICHEL  
46-389  
Klip Uygulayıcı ve çıkarıcı pens  
Clip applying and removing forcep  
13 cm



**1/2**  
COLLIN  
46-390  
Klip çıkarıcı pens  
Clip removing forcep  
13.5 cm



**1/2**  
HEATH  
46-391  
Klip çıkarıcı pens  
Clip removing forcep  
13.5 cm



**1/2**  
46-392  
Düğüm aparatı  
Attachment node  
23 cm



**1/2**  
CASPAR  
46-393  
Düğüm aparatı  
Attachment node  
23 cm



**1/2**  
MICHEL  
46-394  
Klip uygulayıcı penset  
Clip applying forcep  
12.5 cm



**1/2**  
HEGENBARTH  
46-395  
Klip uygulayıcı penset  
Clip applying forcep  
12 cm







46-396

BRUNNER

Kılavuz sondaları/Guiding probes  
30 cm



46-397



46-398

BRUNNER

Bağlama iğneleri/Ligature needles  
30 cm



46-399



REVERDIN  
46-400 - 46-403 19.5 cm  
46-404 - 46-407 22 cm

**47-**



Ø 2.0 mm



**47-100** 13 cm  
**47-101** 14.5 cm  
**47-102** 16 cm  
**47-103** 18 cm  
**47-104** 20 cm

Mirtle yaprak sondalar  
Myrtle leaf probes

Ø 1.5 mm



1/2

**47-105**  
Mirtle yaprak sonda  
Myrtle leaf probe  
14.5 cm



**47-106** Ø 2.5 mm  
14.5 cm  
**47-107** Ø 2.5 mm  
16 cm  
**47-108** Ø 3.0 mm  
20 cm  
Delikli sondalar  
Probes with eye



Ø 3.5 mm

**47-109 - 47-129**  
Sondalar/Probes

Uc çapı

Diameter of tip

1 mm

1.5 mm

2 mm

Uzunluk  
Lenght

**47-109**

**47-116**

**47-123**

13 cm

**47-110**

**47-117**

**47-124**

14.5 cm

**47-111**

**47-118**

**47-125**

16 cm

**47-112**

**47-119**

**47-126**

18 cm

**47-113**

**47-120**

**47-127**

20 cm

**47-114**

**47-121**

**47-128**

25 cm

**47-115**

**47-122**

**47-129**

30 cm

Ø 3 mm



1/2

**47-132**  
Çift başlı sonda  
bükülebilir, delikli  
Double ended probe,  
malleable, with hole  
19 cm

Ø 1.2 mm



1/2

**47-131**  
Sinus sonda  
Sinus probe  
15 cm

1/2

**47-130**  
12.5 cm

Ø 4 mm



1/4

**47-135**  
Çift başlı sonda  
bükülebilir  
Double ended probe,  
malleable  
40 cm

Ø 2.0 mm



1/3

**47-136**  
Sonda/Probe  
30 cm



47-137 Ø 07. + 0.8 mm  
47-138 Ø 0.9 + 1.1 mm  
47-139 Ø 1.3 + 1.4 mm  
47-140 Ø 1.5 + 1.6 mm  
47-141 Ø 1.8 + 1.9 mm  
Sondalar/Probes  
13 cm  
Gümüş/Silver  
BOWMAN



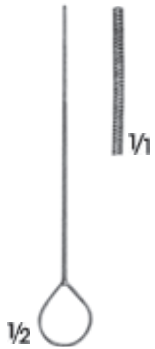
BUCK  
47-142  
Pamuk aplikatör  
Cotton applicator  
Ucu sert burgulu  
Rough, spiral end  
12 cm



47-143  
Sonda/Probe  
16 cm



SEIFFERT  
47-144  
Sonda/Probe  
Gümüş/Silver  
19.5 cm



KINGS'S COLLEGE  
HOSPITAL 47-145  
Pamuk aplikatör  
Cotton applicator  
Sert burgulu  
Rough, spiral end  
9 cm



STACKE  
47-146  
Sonda/Probe  
Gümüş/Silver  
10 cm



KINGS'S COLLEGE HOSPITAL  
47-147  
Pamuk aplikatör  
Cotton applicator  
Sert burgulu  
Rough, spiral end  
13.5 cm



CAWTHORNE  
47-148  
Sonda/Probe  
Yaprak uçlu, gümüş  
Flattened end silver  
14 cm





**FARRELL**  
**47-149**  
Ucu yuvarlak tırtıllı  
Round serrated end  
14 cm



**LATHBURY-FARRELL**  
**47-150**  
Ucu üçgen tırtıllı  
Triangular serrated end  
14 cm



**LATHBURY-FARRELL**  
**47-151**  
Ucu üçgen tırtıllı  
Triangular serrated end  
14 cm



**47-152**  
Ucu sert burgulu  
Rough, spiral end  
14 cm



**47-153**  
Ucu sert burgulu  
Rough, spiral end  
14 cm



**47-154**  
Ucu sert burgulu  
Rough, spiral end  
18 cm



**FARRELL**  
**47-155**  
Ucu sert burgulu  
Rough, spiral end  
16 cm



**LATHBURY-FARRELL**  
**47-156**  
Ucu üçgen tırtıllı  
Triangular serrated end  
16 cm



**LATHBURY-FARRELL**  
**47-157**  
Ucu üçgen tırtıllı  
Triangular serrated end  
16 cm



**47-158**  
Ucu sert burgulu  
Rough, spiral end  
18 cm

Ø 3.5 mm



1/2  
47-159 13 cm  
47-160 14.5 cm  
47-161 16 cm  
İçi kanallı sondalar  
Directors



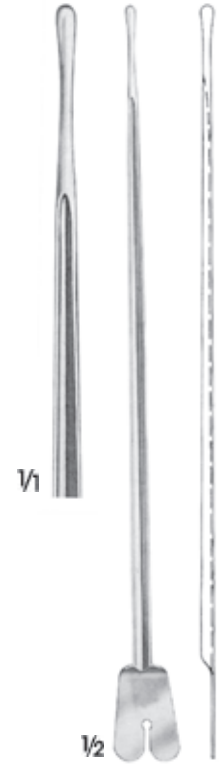
1/2  
DOYEN  
47-162  
İçi kanallı sonda  
Director  
14.5 cm



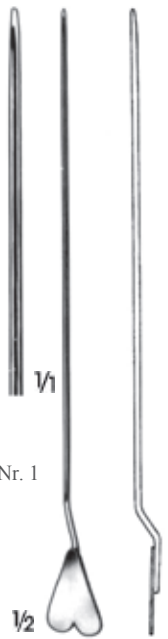
1/2  
NELATON  
47-163  
İçi kanallı sonda  
Director  
16 cm



1/2  
Ø 3.3 mm  
47-164  
İçi klavuzlu sonda  
Director with tip  
14 cm

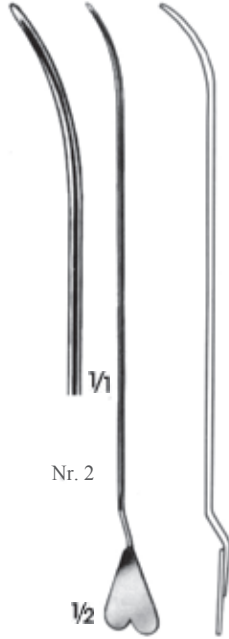


1/2  
BRODIE  
47-165  
İçi klavuzlu sonda  
Director with tip  
20 cm



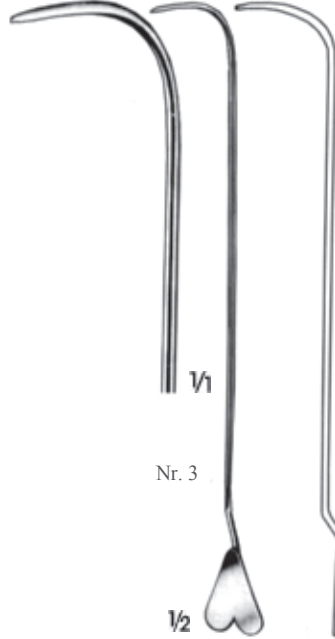
Nr. 1

1/2



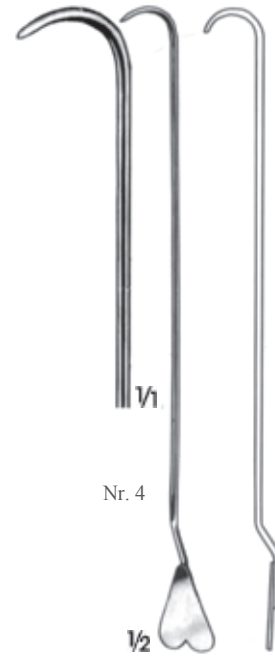
Nr. 2

1/2



Nr. 3

1/2



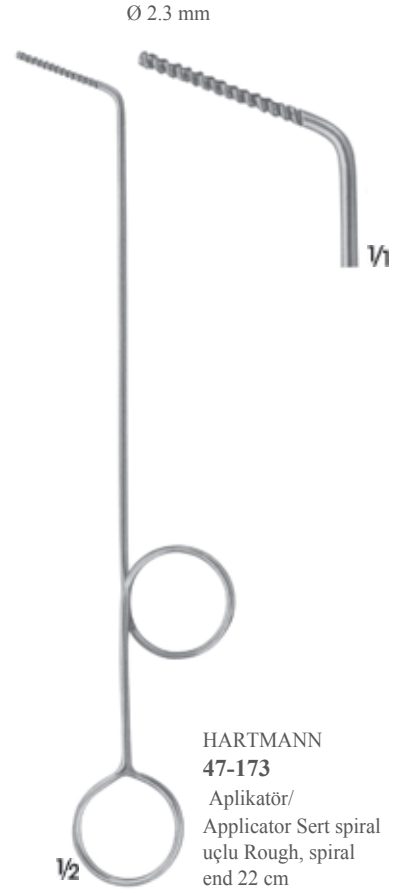
Nr. 4

1/2



1/2  
47-170  
İçi kanallı tel klavuzlu  
sonda, bükülebilir  
Director with wire  
loop, malleable  
19 cm

LOCKHART-MUMMERY  
47-166 Nr. 1 Düz/Straight  
47-167 Nr. 2 45° Eğri/Curved  
47-168 Nr. 3 90° Eğri/Curved  
47-169 Nr. 4 Eğri/Curved  
Fistül sondalar/Fistula probes  
16.5 cm







ZOELLNER

- 47-178** Ø 26 swg, Ø 0.4 mm  
**47-179** Ø 24 swg, Ø 0.5 mm  
**47-180** Ø 22 swg, Ø 0.7 mm  
**47-181** Ø 20 swg, Ø 1.0 mm  
**47-182** Ø 18 swg, Ø 1.2 mm  
 10'luk paket/Package of 10 pieces

1/1



VERHOEVEN

- 47-183** Ø 24 swg, Ø 0.5 mm  
**47-184** Ø 22 swg, Ø 0.7 mm  
**47-185** Ø 20 swg, Ø 1.0 mm  
**47-186** Ø 18 swg, Ø 1.2 mm  
**47-187** Ø 16 swg, Ø 1.5 mm  
 Aspiratör ucu, LUER koniği  
 Suction cannulae with Luer cone  
 10 cm

1/2

Olive  
 Ø 7 mm



1/1

HOUSE  
**47-188**

- Parmak kumandalı emiş adaptörü LUER koniği, LUER bağlantılı  
 Suction adapter with finger cut-off, LUER cone, LUER hub  
 5.5 cm



- 47-189** Ø 1.5 mm  
**47-190** Ø 2.0 mm  
**47-191** Ø 2.5 mm  
**47-192** Ø 3.0 mm

PLESTER

- Parmak kumandalı, temizleme telli parmak basma yüzeyi baş parmağa paralel LUER bağlantı  
 With finger cut-off and stylet, thumb piece parallel to curve, with LUER hub  
 19.5 cm

Olive  
 Ø 6-9 mm

1/2

Ø 3 mm



Olive  
 Ø 8 mm

1/2

ADSON  
**47-193**

- Aspiratör ucu  
 Suction cannula  
 Parmak kumandalı ve temizleme telli  
 With finger cut-off and stylet  
 16.5 cm

Ø 4 mm

Olive  
 Ø 9 mm

1/2

ADSON  
**47-194**

- Parmak kumandalı  
 With finger cut-off  
 19 cm





FERGUSSON

Çalışma boyu Working length	11 cm	13 cm	16 cm	20 cm	
Tam boy Total Length	18 cm	21.5 cm	24.5 cm	28 cm	Ø
	47-195	47-201	47-207	47-213	1.5 mm
	47-196	47-202	47-208	47-214	2.0 mm
	47-197	47-203	47-209	47-215	2.5 mm
	47-198	47-204	47-210	47-216	3.0 mm
	47-199	47-205	47-211	47-217	4.0 mm
	47-200	47-206	47-212	47-218	5.0 mm

Parmak kumandalı, temizleme telli  
parmak basma yüzeyi yatay LUER bağlantı  
With finger cut-of and styled  
Thumb piece 90° to curve, With LUER hub



FRAZIER

- 47-219 Ø 2.3 mm
- 47-220 Ø 2.7 mm
- 47-221 Ø 3.4 mm
- 47-222 Ø 4.0 mm

Parmak kumandalı, temizleme  
telli parmak basma yüzeyi yatay  
LUER bağlantı  
With finger cut-of and stylet  
Thumb piece 90° to curve,  
with LUER hub  
11 cm

Olive  
Ø 6-9 mm



FERGUSSON

47-223 Ø 4 mm  
İzoleli, parmak kumandalı,  
temizleme telli  
parmak basma yüzeyi yatay  
LUER bağlantı  
Isulated, with finger cut-of and stylet,  
thumb piece 90° to curve, with LUER  
hub  
18 cm

Olive  
Ø 6-9 mm



FRAZIER

47-224 Ø 3 mm  
47-225 Ø 5 mm  
Parmak kumandalı, temizleme  
telli parmak basma yüzeyi  
yatay LUER bağlantı  
With  
Thumb piece 90° to curve,  
with LUER hub  
18 cm



Olive  
Ø 9 mm  
FORMBY  
47-226 Ø 3.3 mm  
21 cm



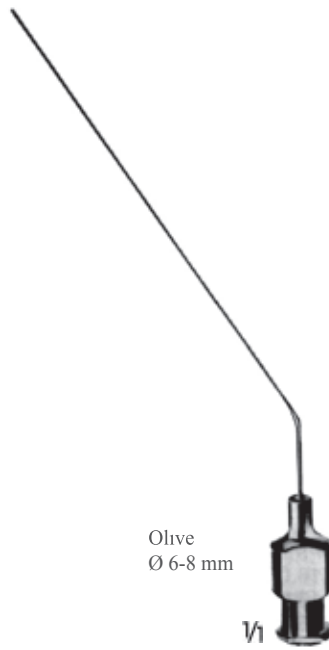
Olive  
Ø 6-9 mm  
GILLIES  
47-227 Ø 3 mm  
Parmak kumandalı ve  
temizleme telli  
With finger cut-off and stylet  
17 cm



Olive  
Ø 7-9 mm  
LEMPERT  
47-228 Ø 2 mm  
47-229 Ø 3 mm  
Parmak kumandalı ve  
temizleme telli  
With finger cut-off and stylet  
20 cm



Olive  
Ø 6-8 mm  
WULLSTEIN  
47-229 Ø 0.4 mm  
47-230 Ø 0.6 mm  
47-231 Ø 0.8 mm



Olive  
Ø 6-8 mm  
47-232 Komple/Complete  
47-233 Sap/Handle  
47-234 Ø 0.5 mm  
47-235 Ø 0.7 mm  
47-236 Ø 1.0 mm  
47-237 Ø 1.3 mm  
LUER koniği/With LUER cone





Ø 1.75 mm

Ø 0.3 mm  
Olive  
Ø 6-9 mm

1/2

**WULLSTEIN**  
**47-238**  
Aspiratör ucu  
konik şeklinde gümüş  
Suction tube  
conical, silver  
LUER bağlantılı  
With LUER hub  
16 cm

Olive  
Ø 8 mm

1/2

**WULLSTEIN**  
**47-239** Ø 1.5 mm  
**47-240** Ø 2.0 mm  
Gümüş/Silver  
LUER bağlantılı  
With LUER hub  
16 cm

Olive  
Ø 8 mm

1/2

**SCHUKNECHT**  
**47-241** Ø 1 mm  
**47-242** Ø 0.5 mm  
Aspiratör ucu Suction  
cannulae 13 cm

Olive  
Ø 8 mm

1/2

**BARRON**  
**47-243** Ø 1.3 mm  
**47-244** Ø 2 mm  
Parmak kumandalı ve  
temizleme telli  
With finger cut-off and stylet  
16 cm

1/1

Olive  
Ø 8 mm

1/2

**BELLUCCI**  
**47-245** Komple/Complete  
**47-246** Parmak kumandalı ve  
temizleme telli  
With finger cut-off and stylet  
**47-247** Ø 0.5 mm  
**47-248** Ø 0.7 mm  
**47-249** Ø 1.0 mm  
15.5 cm

Ø 2.5 mm

Olive  
Ø 8 mm

1/2

**ZOELLNER**  
**47-250**

**47-251**

Uc genişliği 6.5 mm  
Tip wide 6.5 mm  
Burun aspiratör ucu, LUER bağlantılı  
Nasal suction tube, with LUER hub  
18 cm



**GORNEY**

**47-252**

Aspiratör disektör  
Suction dissector  
18 cm



**NEGUS**

**47-253**

Aspiratör disektör  
Suction dissector  
21 cm



**YASARGIL**

**47-254**

Kanül/Cannulae  
LUER-LOC koniği  
LUER-LOC cone  
20 cm



**LOPEZ-REINKE**

**47-255**

Aspirasyonlu Tonsil disektör  
Tonsil dissector with suction  
device  
23.5 cm



LANDOLT

**47-256** Genişlik/Wide 3.2 mm  
Hipofizektomi ve Kbb için aspiratör ucu,  
keskin açılı nokta  
Dissecting suction tube for hypophysectomie  
and ENT, sharp agled point  
20 cm



Olive  
Ø 6-9 mm

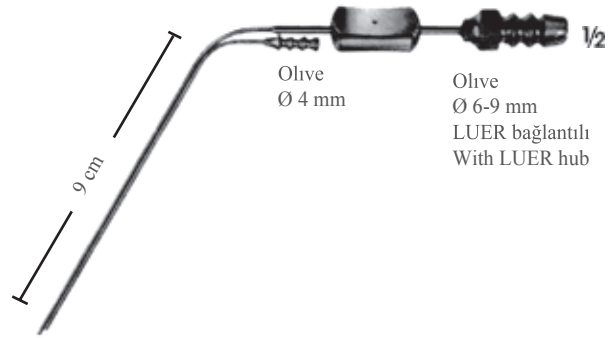
**47-257** 4 mm  
**47-258** 5 mm  
Aspiratör raspa, sivri bayonet tip  
Suction raspatories, sharp  
bayonet-shaped  
20 cm



Olive  
Ø 6-9 mm

HOUSE

**47-259** Ø 0.9 - 0.7 mm  
**47-260** Ø 1.2 - 0.9 mm  
**47-261** Ø 1.5 - 1.2 mm  
Parmak kumandalı ve temizleme telli  
With finger cut-off and stylet



Olive  
Ø 4 mm

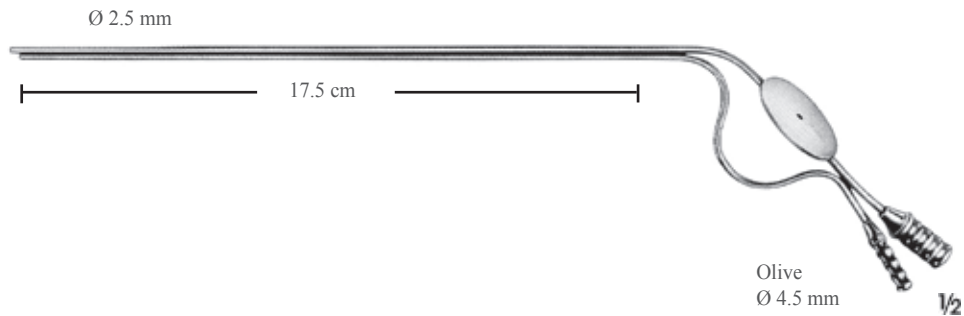
Olive  
Ø 6-9 mm  
LUER bağlantılı  
With LUER hub

**47-262** Ø 2.0 mm  
**47-263** Ø 2.5 mm  
**47-264** Ø 3.0 mm  
Parmak kumandalı ve temizleme telli  
parmak basma yüzeyi yatay  
With finger cut-off, thumb piece 90° to curve  
25 cm



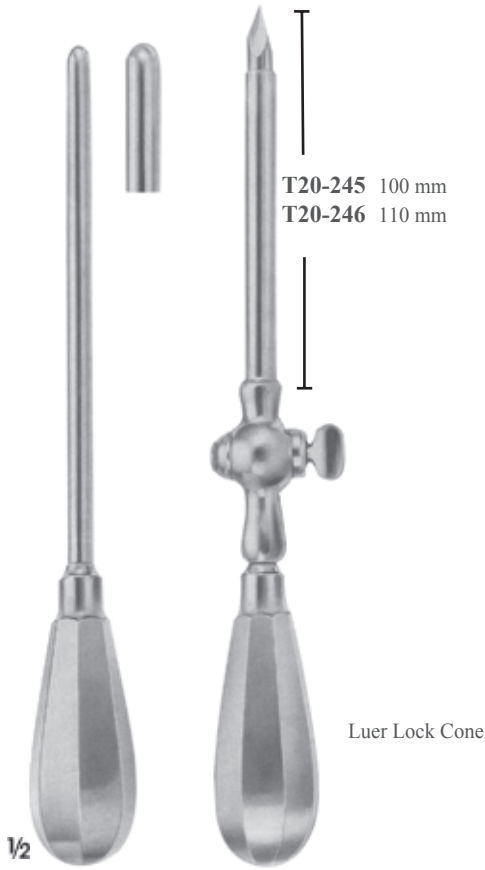
Olive  
Ø 6-9 mm  
LUER bağlantılı  
With LUER hub

**47-265**  
Parmak kumandalı ve  
temizleme telli  
With finger cut-off and stylet



Olive  
Ø 4.5 mm

1/2



T20-245 100 mm  
T20-246 110 mm

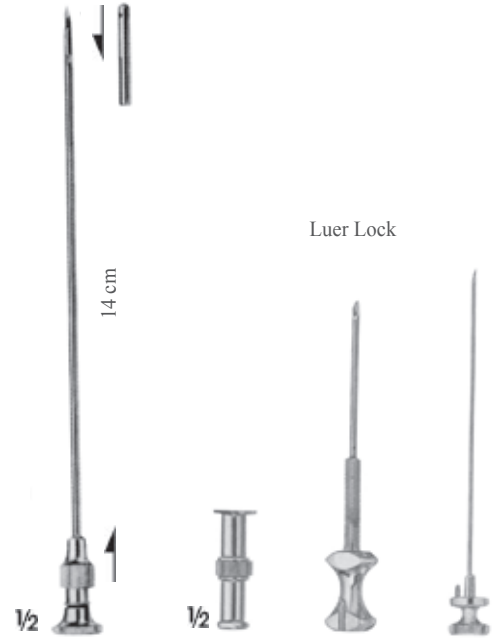
Luer Lock Cone

$\frac{1}{2}$   
BUELAU  
İç/Inside Dış/Outside  
47-266 Ø 6.5 mm Ø 8.0 mm  
47-267 Ø 9.0 mm Ø 10.0 mm  
Ampiyem trokar  
Empyema trocar



$\frac{1}{2}$

İç/Inside Dış/Outside  
47-268 Ø 2.2 mm Ø 3.3 mm  
47-269 Ø 3.0 mm Ø 4.0 mm  
47-270 Ø 4.0 mm Ø 5.0 mm  
47-271 Ø 5.0 mm Ø 6.0 mm  
Yandan boşaltmalı musluklu, karın  
delme trokarı  
For abdominal puncture, with  
stop-cock and lateral drain.



14 cm

$\frac{1}{2}$

LANDAU  
47-272  
Ø 2 mm  
Pelvik apse trokar  
Pelvic abscess trocar

$\frac{1}{2}$

KLIMA-ROSEGGER  
47-273 35 x 1,8 mm  
Göğüs kemiği delici iğne  
Sternal puncture needle

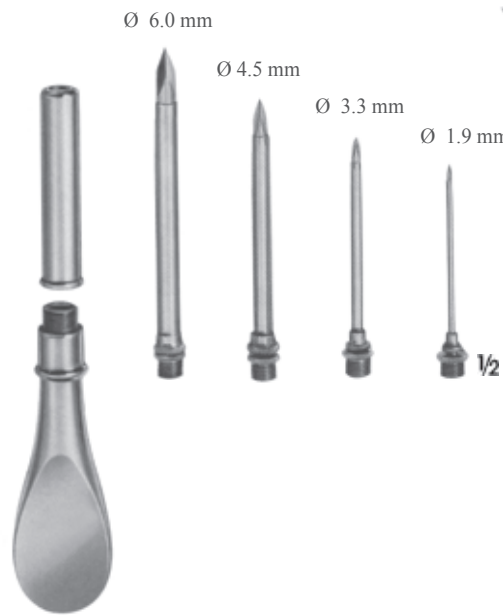
Luer Lock



Rekord koniği  
With record cone

$\frac{1}{2}$

KRAUSE  
47-274 Ø 4.0 mm  
Antrum trokar Antrum  
trocar



Ø 6.0 mm

Ø 4.5 mm

Ø 3.3 mm

Ø 1.9 mm

$\frac{1}{2}$

47-275  
4 ucu ile birlikte  
sökülebilir trokar  
Trocar with interchangeable  
tips (4 pcs.)



Rekord koniği  
With record cone

$\frac{1}{2}$

PIERCE  
47-276 Ø 4.0 mm  
Antrum trokar  
Antrum trocar



POOL

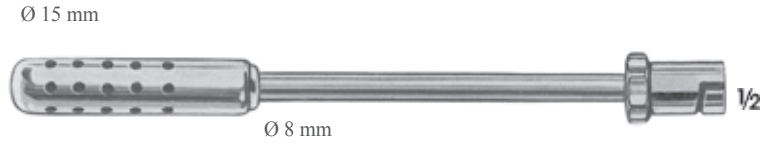
**47-277**

Aspiratör kanülü, vidalanabilir dış tüpü ile  
Suction cannula, with outer tube to be  
screwed off  
22.5 cm



**47-278**

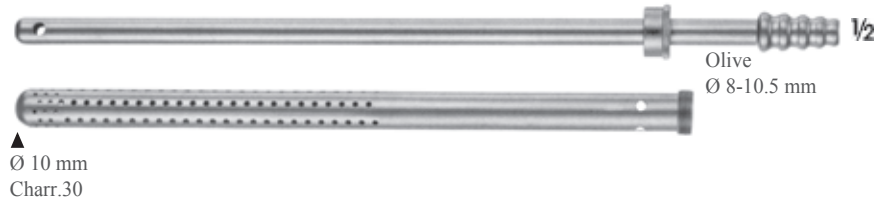
Büyük miktarda sıvı temizlemek için  
For clearing large quantities of fluid  
19 cm



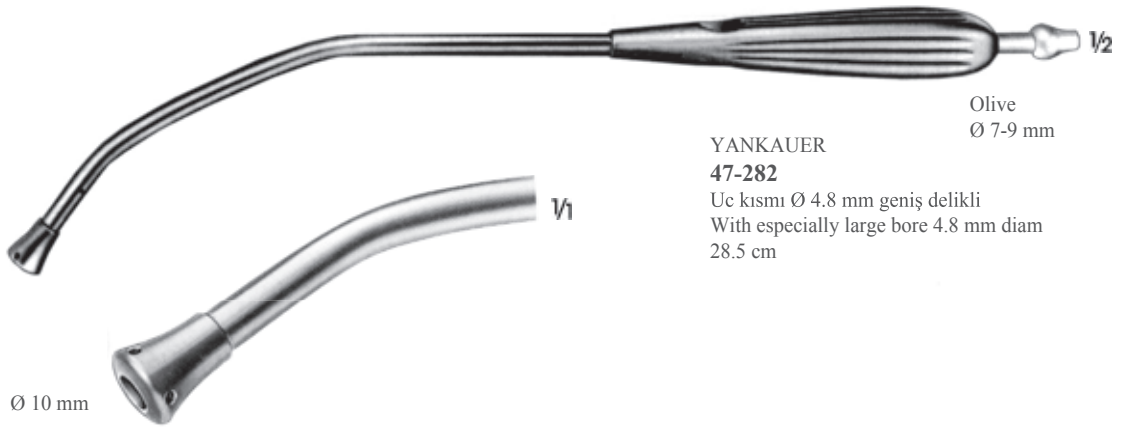
POOL

**47-279**

Aspiratör kanülü, vidalanabilir dış tüpü ile  
Suction cannula, with outer tube to be  
screwed off  
22.5 cm





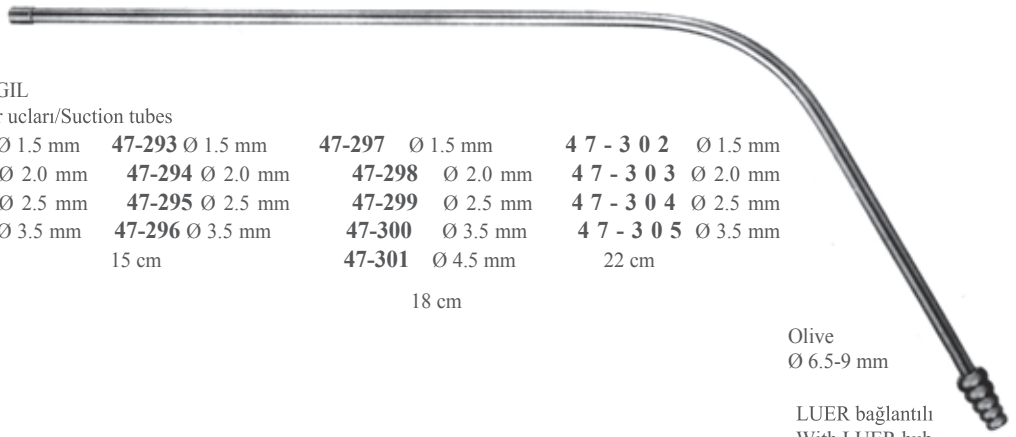




**MAGILL**  
**47-285** Ø 3.0 mm  
**47-286** Ø 3.5 mm  
**47-287** Ø 4.0 mm  
 Magil emiş kanülü  
 Stylet for magill suction tubes  
 24.5 cm



**ROWBOTHAM**  
**47-288**  
 Kanül/  
 Cannulae 29.5  
 cm



**YASARGIL**

Aspiratör uçları/Suction tubes

<b>47-289</b> Ø 1.5 mm	<b>47-293</b> Ø 1.5 mm	<b>47-297</b> Ø 1.5 mm	<b>47-302</b> Ø 1.5 mm
<b>47-290</b> Ø 2.0 mm	<b>47-294</b> Ø 2.0 mm	<b>47-298</b> Ø 2.0 mm	<b>47-303</b> Ø 2.0 mm
<b>47-291</b> Ø 2.5 mm	<b>47-295</b> Ø 2.5 mm	<b>47-299</b> Ø 2.5 mm	<b>47-304</b> Ø 2.5 mm
<b>47-292</b> Ø 3.5 mm	<b>47-296</b> Ø 3.5 mm	<b>47-300</b> Ø 3.5 mm	<b>47-305</b> Ø 3.5 mm
13 cm	15 cm	<b>47-301</b> Ø 4.5 mm	22 cm
		18 cm	

Olive  
 Ø 6.5-9 mm

LUER bağlantılı  
 With LUER hub

Ø 3,5 mm

Ø 2,0 mm

**47-306** 50 cm  
**47-307** 35 cm  
 Aspiratör uçları/Suction tubes  
 Lastik uclu  
 With rubber tip

Olive  
 Ø 6-9 mm

LUER bağlantılı  
 With LUER hub



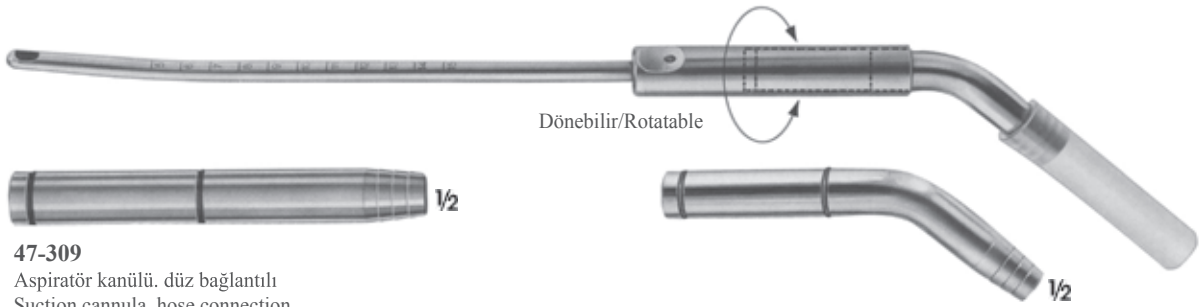


Ø 15 mm

FINSTERER  
**47-308**  
Sulama kanülü  
Irrigation cannula  
32 cm

Olive  
Ø 9 -13 mm

1/2



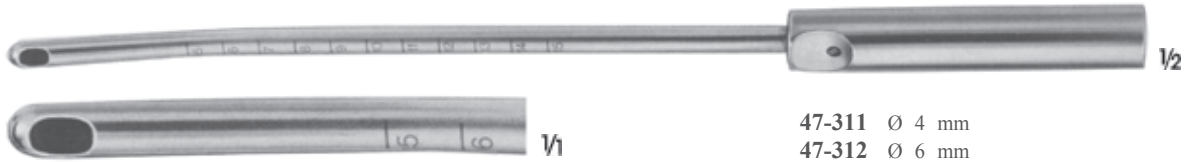
Dönebilir/Rotatable

**47-309**

Aspiratör kanülü, düz bağlantılı  
Suction cannula, hose connection  
straight  
Ø 11 mm

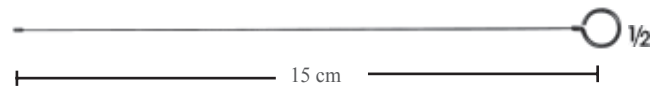
**47-310**

Aspiratör kanülü, eğri bağlantılı  
Suction cannula, hose connection,  
curved  
Ø 11 mm



**47-311** Ø 4 mm  
**47-312** Ø 6 mm  
**47-313** Ø 8 mm  
**47-314** Ø 10 mm  
**47-315** Ø 12 mm  
**47-316** Ø 14 mm

Vakum küreti, vakumlu kürtaj  
için emme kanülü  
Curette with graduation and suction  
interrupter, for vaccum curettage



15 cm

Vakum hortumu için bağlantı  
Connection for suction hose

LANDOLT

**47-317** İzoleli/Insulated  
Pıhtı emiş kanülü, mandrenli ve stoplu Ø 5 mm  
143 ° buhar sterilizatörlerinde steril edilebilir.  
Coagulation suction cannula  
with interrupter and mandrel Ø 5 mm  
Can be sterilized in a steam sterilizer up to 143 °

Çap/Olive  
Ø 7.5-12 mm

HF elektrotları tarafından dokunulmuş,  
lekelenmemiş bağlantı Ø 4 mm  
HF-Elektrot kolu Ø 4 mm  
Untarnished contact to be  
touched by HF-electrodes Ø 4 mm

**48**



48-100  
12 cm



48-101  
11 cm



48-102  
14.5 cm



48-103  
Sivri/Sharp  
12.5 cm



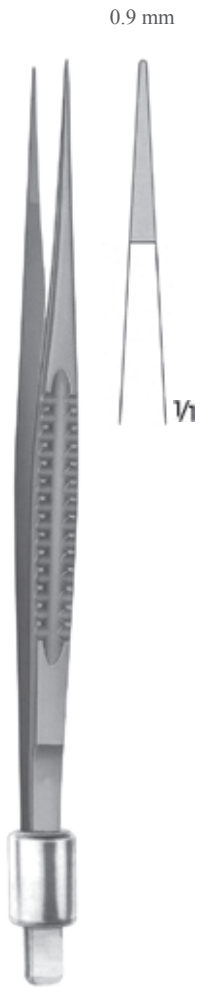
48-104  
Hassas/Delicate  
17.5 cm



48-105  
Hassas/Delicate  
22 cm



Yapışmaz/Non sticking



**48-106**  
Düz/Straight  
İzolesiz/Non-insulated  
16 cm



**48-107**  
Düz/Straight  
İzolesiz/Non-insulated  
18.5 cm



**48-108**  
Düz/Straight  
İzolesiz/Non-insulated  
20 cm



**48-109**  
Açılı/Angled  
İzolesiz/Non-insulated  
16 cm

Izoleli  
Insulated



**48-110**  
Açılı/Angled  
İzolesiz/Non-insulated  
20 cm





Izoleli  
Insulated



**48-111** 0.6 mm  
**48-112** 0.9 mm  
16 cm  
**48-113** 0.9 mm  
20 cm

Izoleli  
Insulated

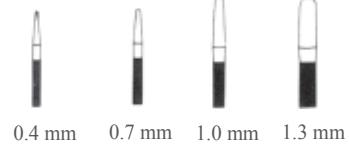


**48-114** 0.9 mm  
20 cm  
**48-115** 0.9 mm  
16 cm

Izoleli  
Insulated



**48-116** 0.4 mm  
**48-117** 0.7 mm  
**48-118** 1.0 mm  
**48-119** 1.3 mm  
14 cm  
**48-120** 0.4 mm  
**48-121** 0.7 mm  
**48-122** 1.0 mm  
**48-123** 1.3 mm  
15.5 cm



#### Özellikler

- Doku hazırlanması ve ayırması için uygun.
- Yuvarlak çalışma uçları.
- Dayanıklı izolasyon kaplaması.
- Güvenilir fişli bağlantı.

#### Features

- Suitable for tissue preparation and spreading.
- Rounded working tips.
- Durable insulation coating.
- Reliable plug-in connection.

**48-124** 0.4 mm  
**48-125** 0.7 mm  
**48-126** 1.0 mm  
**48-127** 1.3 mm  
17.5 cm  
**48-128** 0.4 mm  
**48-129** 0.7 mm  
**48-130** 1.0 mm  
**48-131** 1.3 mm  
19.5 cm  
**48-132** 0.4 mm  
**48-133** 0.7 mm  
**48-134** 1.0 mm  
**48-135** 1.3 mm  
21.5 cm  
**48-136** 0.4 mm  
**48-137** 0.7 mm  
**48-138** 1.0 mm  
**48-139** 1.3 mm  
23.5 cm  
**48-140** 0.7 mm  
25.5 cm

Izoleli  
Insulated



Özellikler

- İnce, hassas, yuvarlak, parlak çalışma
- Dayanıklı izolasyon kaplaması.
- Güvenilir fişli bağlantı.

Features

- Slim, delicate, rounded, polished working tips.
- Durable insulation coating.
- Reliable plug-in connection.

<b>48-141</b>	0.2 mm	<b>48-149</b>	0.2 mm
<b>48-142</b>	0.5 mm	<b>48-150</b>	0.5 mm
<b>48-143</b>	1.0 mm	<b>48-151</b>	1.0 mm
<b>48-144</b>	2.0 mm	<b>48-152</b>	2.0 mm
16.5 cm		22 cm	
<b>48-145</b>	0.2 mm		
<b>48-146</b>	0.5 mm		
<b>48-147</b>	1.0 mm		
<b>48-148</b>	2.0 mm		
19.5 cm			

Izoleli  
Insulated



<b>48-153</b>	1.0 mm
16.5 cm	
<b>48-154</b>	1.0 mm
19.5 cm	
<b>48-155</b>	1.0 mm
22 cm	

Izoleli  
Insulated



- Halka uçlar
- Dayanıklı izolasyon kaplaması.
- Güvenilir fişli bağlantı.
- Ring tips
- Durable insulation coating.
- Reliable plug-in connection.

<b>48-156</b>	2/3 mm	<b>48-159</b>	2/3 mm
<b>48-157</b>	3/4 mm	<b>48-160</b>	3/4 mm
<b>48-158</b>	4/5 mm	<b>48-161</b>	4/5 mm
19.5 cm		23.5 cm	







Ucu tam izoleli  
Fully insulated

Ucu yarım izoleli  
Fully insulated

Ucu tam izoleli  
Fully insulated

Ucu yarım izoleli  
Fully insulated



Ucu tam izoleli  
Fully insulated

Ucu yarım izoleli  
Fully insulated



48-172

48-173



48-174

48-175

48-162 16 cm  
48-163 20 cm  
48-164 23 cm  
48-165 25 cm  
48-166 30 cm  
Ucu tam izoleli tip  
Fully insulated tip

48-167 16 cm  
48-168 20 cm  
48-169 23 cm  
48-170 25 cm  
48-171 30 cm  
Ucu yarım izoleli tip  
Fully insulated tip

1/2  
48-172  
48-173  
20 cm

BARRE  
48-174  
48-175  
26 cm



**48-176** 18 cm  
**48-177** 20 cm  
**48-178** 24 cm  
**48-179** 30 cm  
İzoleli/Insulated



**48-180** 18 cm  
**48-181** 20 cm  
**48-182** 24 cm  
**48-183** 30 cm  
İzoleli/Insulated  
1 x 2 diş/1 x 2 teeth

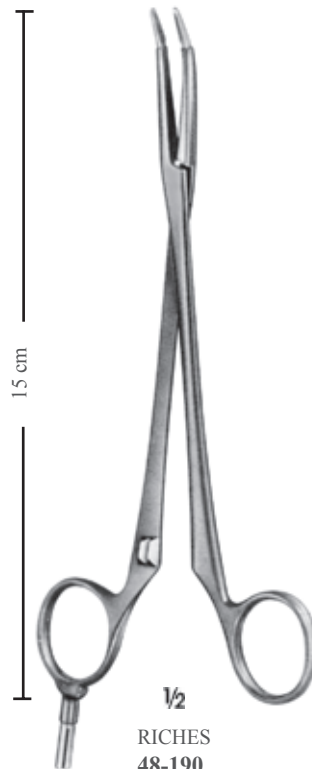


**48-184** 20 cm  
**48-185** 24 cm  
**48-186** 30 cm  
İzoleli/Insulated

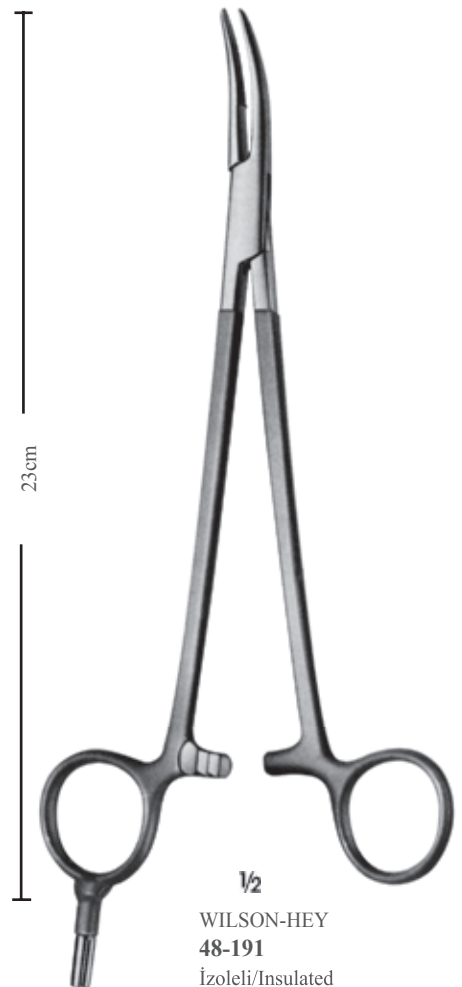
Atromatik  
Atraumatic



**48-187** 18 cm  
**48-188** 20 cm  
**48-189** 23 cm  
Makas, İzoleli  
Scissors, insulated



$\frac{1}{2}$   
**RICHES**  
**48-190**  
İzoleli/Insulated  
17.5 cm



$\frac{1}{2}$   
**WILSON-HEY**  
**48-191**  
İzoleli/Insulated  
25.5 cm





Ø 2.4 mm **48-192**  
Ø 4.0 mm **48-193**  
Halkalı elektrotlar  
Loop electrodes



Ø 2.4 mm **48-194**  
Ø 4.0 mm **48-195**  
Halkalı elektrotlar  
Loop electrodes



Ø 2.4 mm **48-196**  
Ø 4.0 mm **48-197**  
Halkalı elektrotlar  
Loop electrodes

Ø 4 mm



Ø 2.4 mm



Ø 2.4 mm **48-198**  
Ø 4.0 mm **48-190**  
Küresel elektrotlar  
Ball electrodes



Ø 2.4 mm **48-200**  
Ø 4.0 mm **48-201**  
Küresel elektrotlar  
Ball electrodes



Ø 2.4 mm **48-202**  
Ø 4.0 mm **48-203**  
Plaka elektrotlar  
Plate electrodes



Ø 2.4 mm **48-204**  
Ø 4.0 mm **48-205**  
Bıçak elektrotları  
Knife electrodes



Ø 2.4 mm **48-206**  
Ø 4.0 mm **48-207**  
Kesme elektrotlar  
Cutting electrodes



Ø 2.4 mm **48-208**  
Ø 4.0 mm **48-209**  
Kesme elektrotlar  
Cutting electrodes

Ø 4 mm



Ø 2.4 mm



Ø 2.4 mm **48-210**  
Ø 4.0 mm **48-211**  
Kesme elektrotlar  
Cutting electrodes



Ø 2.4 mm **48-212**  
Ø 4.0 mm **48-213**  
İğne elektrotlar  
Needle electrodes

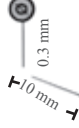


Ø 2.4 mm **48-214**  
Ø 4.0 mm **48-215**  
Halkalı elektrotlar  
Loop electrodes





**48-216**  
İğne elektrot  
Needle electrode



**48-217**  
İğne elektrot  
Needle electrode



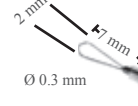
**48-218**  
İğne elektrot  
Needle electrode



**48-219**  
Halkalı elektrot  
Loop electrode



**48-220**  
Halkalı elektrot  
Loop electrode



**48-221**  
Halkalı elektrot  
Loop electrode



**48-222**  
Küresel elektrot  
Ball electrode

Ø 1.7 mm



**48-223**  
Küresel elektrot  
Ball electrode



**48-224** Komplete/Complete  
12 adet cerrahi elektrot/Surgical lead of 12

**48-225** Komplete/Complete  
12 adet cerrahi elektrot/Surgical lead of 12



**48-226**  
Kapaklı elektrot konteyneri  
Container with lid for electrodes



**48-227**  
Mikro cerrahi elektrotlar için rak  
Rack for micro electrodes



**48-228**  
Cerrahi elektrotlar için rak  
Rack for surgery electrodes



**48-229**

En/Wide 3.5 mm



**48-230**

Açılı kesme elektrodu  
Angled cutting electrode  
Boy/Length 14 mm  
En/Wide 1.8 mm



**48-231**

Kesme elektrodu, hassas  
Cutting electrode, delicate  
25 mm



**48-232**

Bıçak elektrod  
Knife electrode  
25 mm



**48-233**

Bıçak elektrod  
Knife electrode  
18 mm



**48-234**

Plaka elektrod  
Plate electrode

Oval kesme elektrodu  
Cutting electrode  
Boy/Length 30 mm



**48-235**

Halkalı elektrot  
Loop electrode  
Ø 10 mm  
Tel Ø 3 mm/Wire Ø 3 mm



**48-236**

Halkalı elektrot  
Loop electrode  
Ø 15 mm



**48-237**

Açılı halkalı elektrot  
Angled loop electrode  
Ø 8 mm



**48-238**

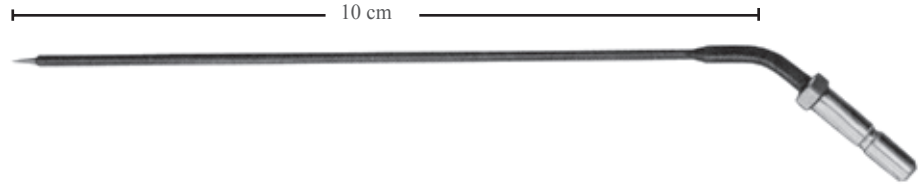
Ø 2.5 mm  
**48-239** Ø 4 mm  
**48-240** Ø 6 mm  
Küresel uçlu elektrotlar  
Ball point electrodes



**48-241**

Ø 0.3 mm  
**48-242** Ø 0.5 mm  
**48-243** Ø 0.7 mm  
İğne elektrotlar  
Needle electrode  
25 mm





Burun için iğne elektrot 48-244

Needle elektrode for nasal concha



48-245  
İğne elektrot  
Needle elektrode



48-246  
Bıçak elektrot  
Knife elektrode



48-247  
Halkalı elektrot  
Wire loop elektrode



48-248  
Halkalı elektrot  
Wire loop elektrode



48-249  
Halkalı elektrot  
Wire loop elektrode  
10 x 10 mm



48-250  
Halkalı elektrot  
Wire loop elektrode  
15 x 15 mm



48-251  
Halkalı elektrot  
Wire loop elektrode  
20 x 20 mm

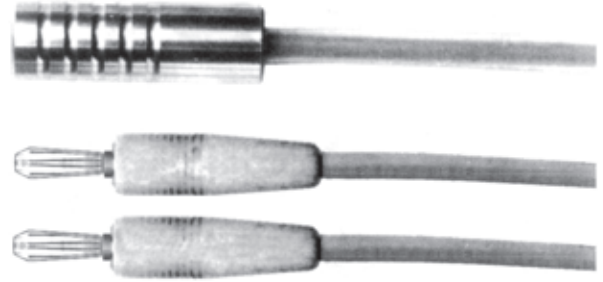




**48-252**  
Elektrot tutucusu  
Electrode holder



**48-253**  
Ayrılabilir aletler için kablo  
Instrument cable for detachable



**48-254**  
Bipolar kordon  
Bipolar cord  
2 mt.

**48-255**  
Bipolar kordon  
Bipolar cord  
3 mt.



ABBEY  
**48-256**  
Mukuza iğne  
Mucosa needle







**49**



De Bakey Diş



Toothing De BAkey



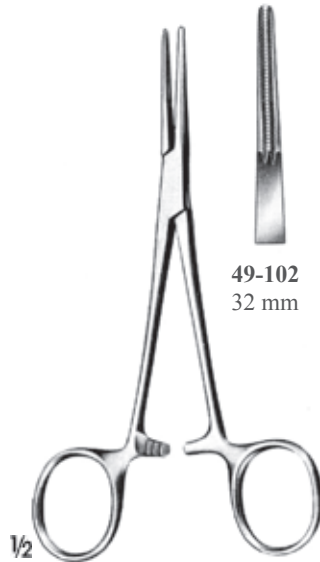
49-100  
20 mm



49-101  
20 mm

1/2

MOSQUITO  
12.5 cm



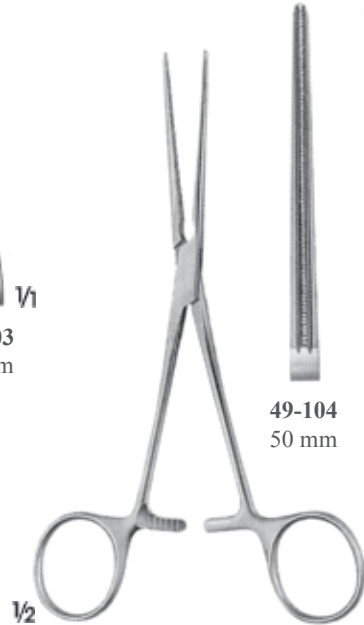
49-102  
32 mm



49-103  
32 mm

1/2

DE BAKEY-KELLY  
14 cm



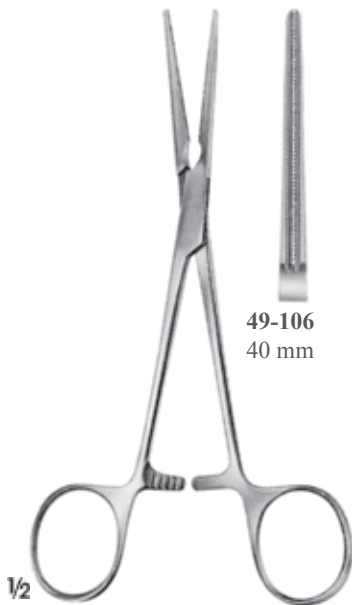
49-104  
50 mm



49-105  
50 mm

1/2

PEAN  
15.5 cm



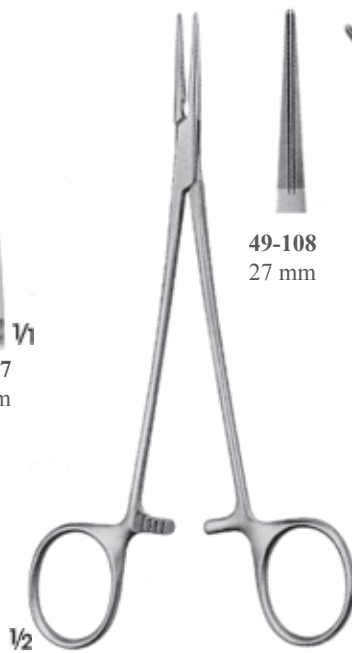
49-106  
40 mm



49-107  
40 mm

1/2

DE BAKEY-BAINBRIDGE  
15.5 cm



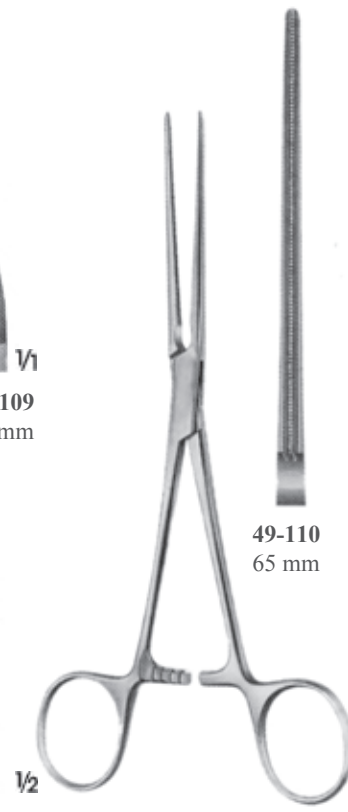
49-108  
27 mm



49-109  
27 mm

1/2

16.5 cm



49-110  
65 mm



49-111  
65 mm

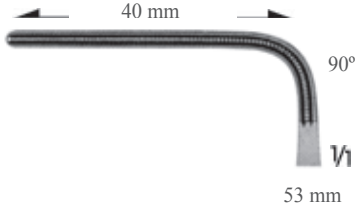
1/2

DE BAKEY-BAINBRIDGE  
18 cm

De Bakey Diş



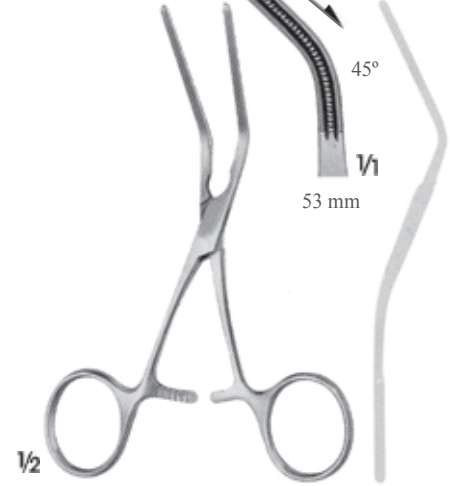
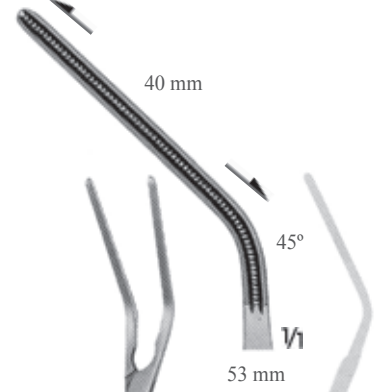
Toothing De BAkey



DE BAKEY  
49-112  
90° açılı/Angled 90°  
10.5 cm



NOON  
49-113  
40° açılı/Angled 40°  
11 cm



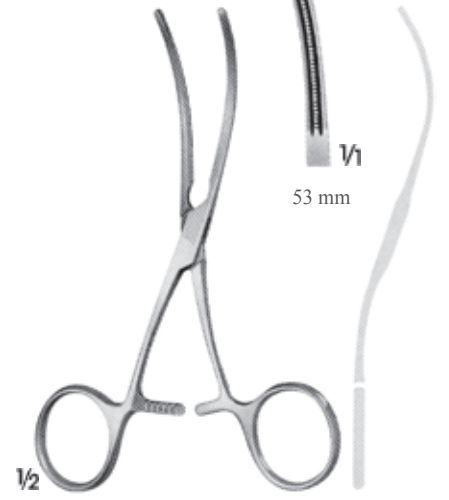
DE BAKEY  
49-114  
45° açılı/Angled 45°  
12.5 cm



DE BAKEY  
49-115  
Düz/Straight  
13 cm



DE BAKEY  
49-116  
Eğri/Curved  
12.5 cm



DE BAKEY  
49-117  
S-Biçimli/S-shaped  
12.5 cm

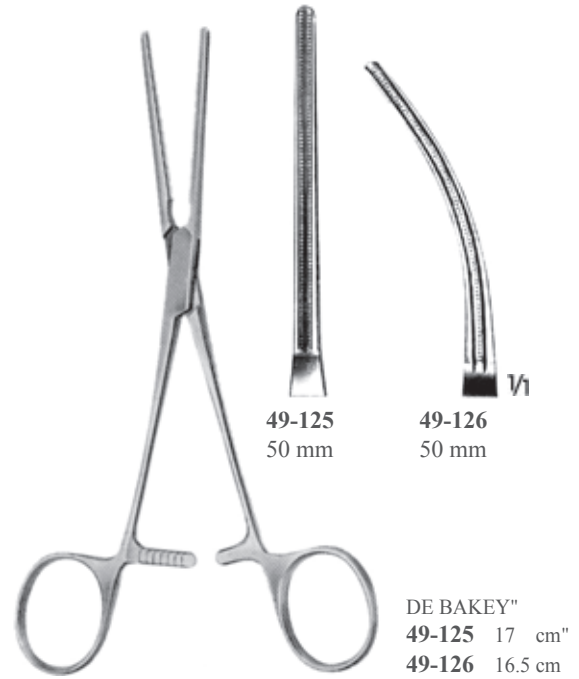
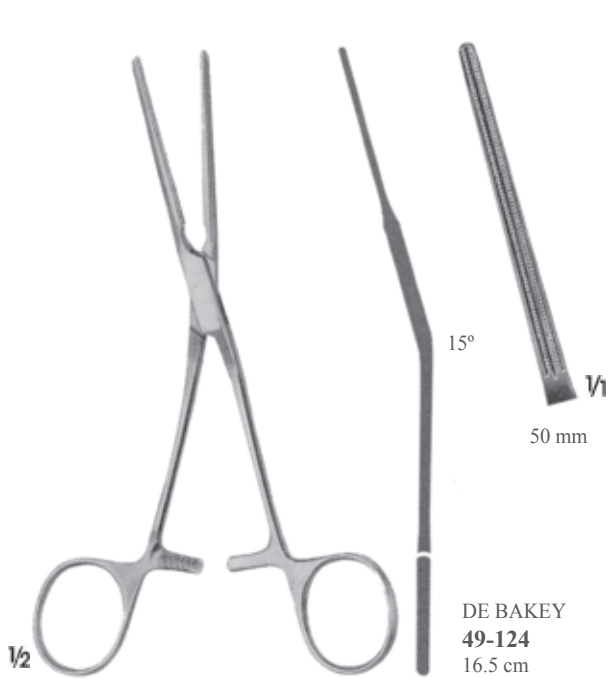




De Bakey Diş



Toothing De BAkey



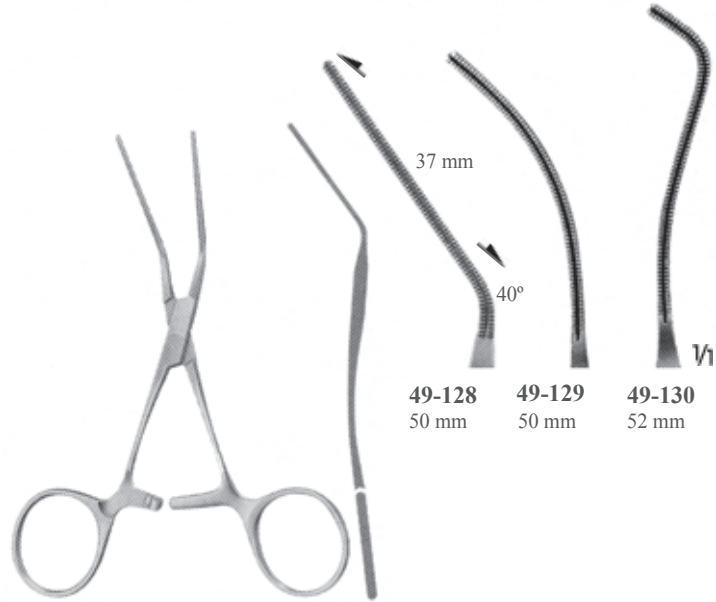
Cooley Diş



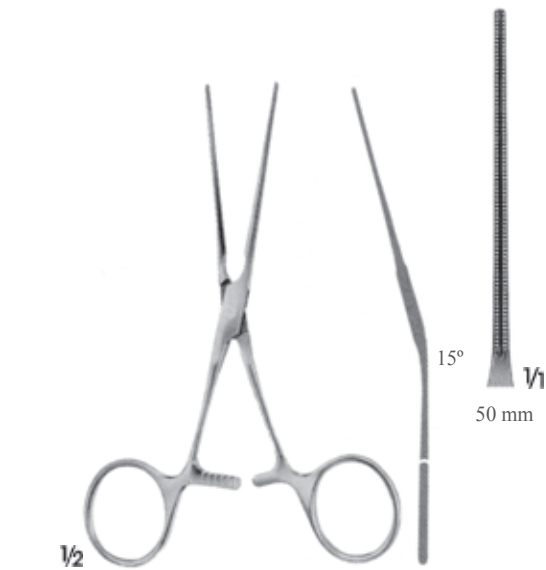
Toothing Cooley



COOLEY  
49-127  
10 cm



COOLEY  
49-128 12 cm  
49-129 12.5 cm  
49-130 12.5 cm



COOLEY  
49-131  
12.5 cm



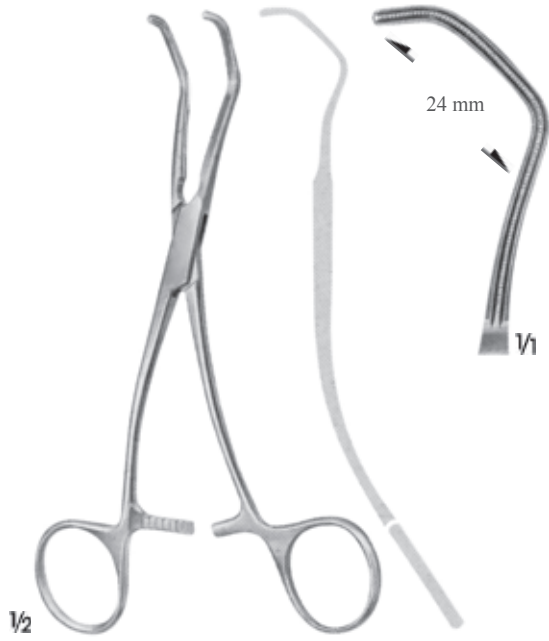
COOLEY  
49-132 12.5 cm  
49-133 11.5 cm



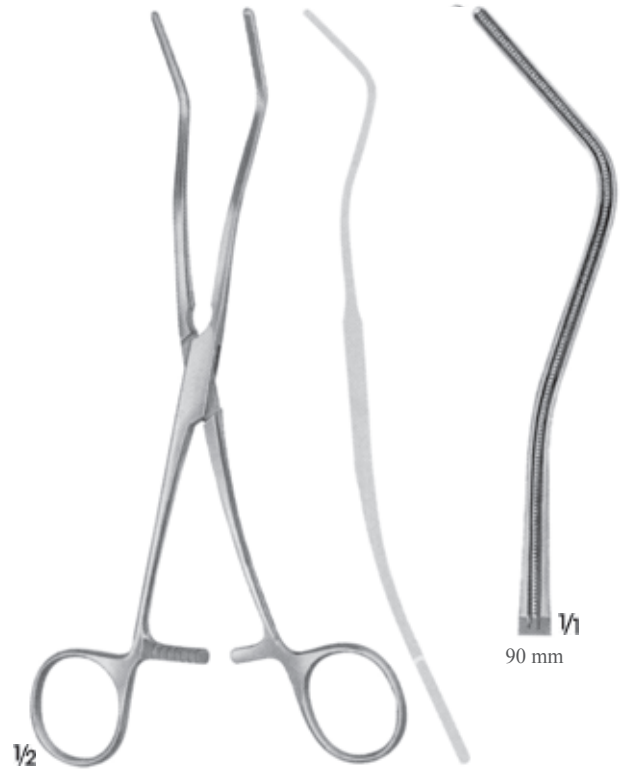
De Bakey Diş



Toothing De BAkey



COOLEY  
49-134  
16 cm



COOLEY  
49-135  
20 cm



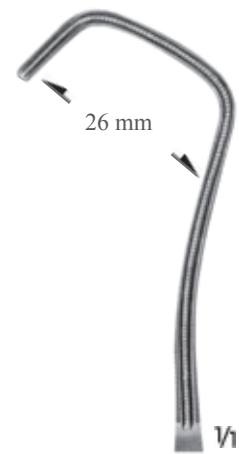
DERRA  
49-136 - 49-138



49-136  
17 cm



49-137  
17 cm



49-138  
17.5 cm



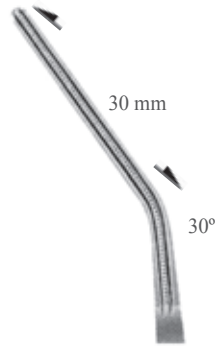
De Bakey Diş



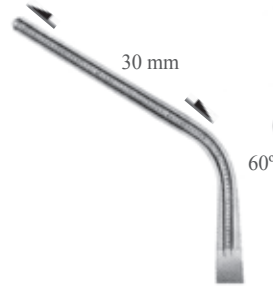
Toothing De BAkey



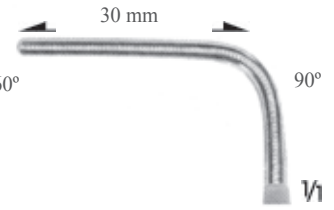
COOLEY  
49-139 - 49-141



49-139  
16.5 cm



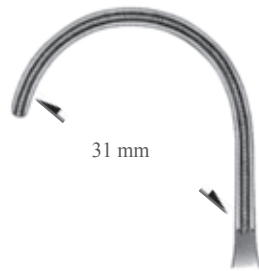
49-140  
16 cm



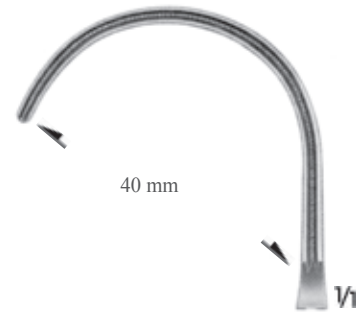
49-141  
15 cm



DE BAKEY  
T18-044 - T18-045



49-142  
16 cm



49-143  
17 cm





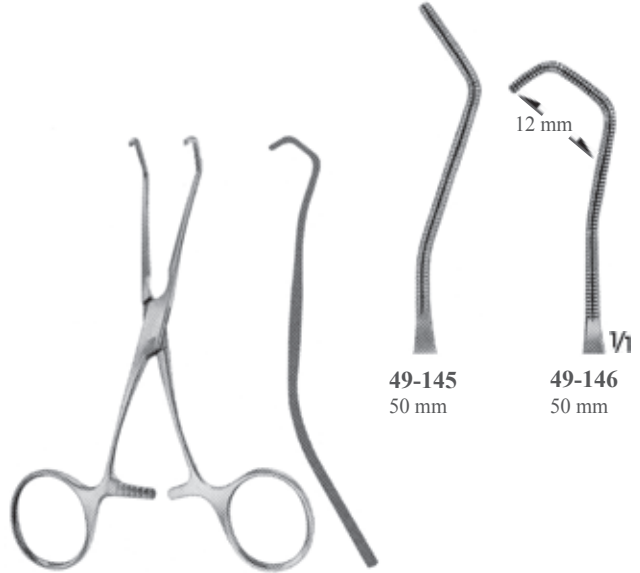
Cooley Diş



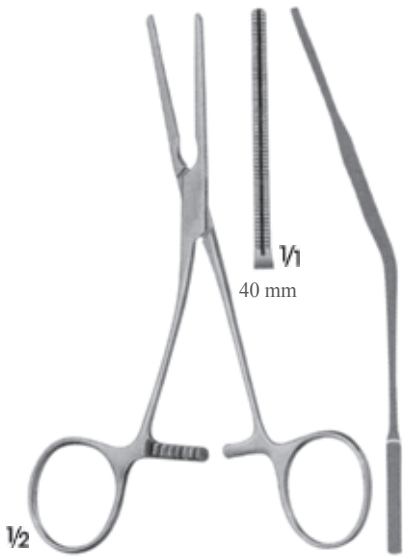
Toothing Cooley



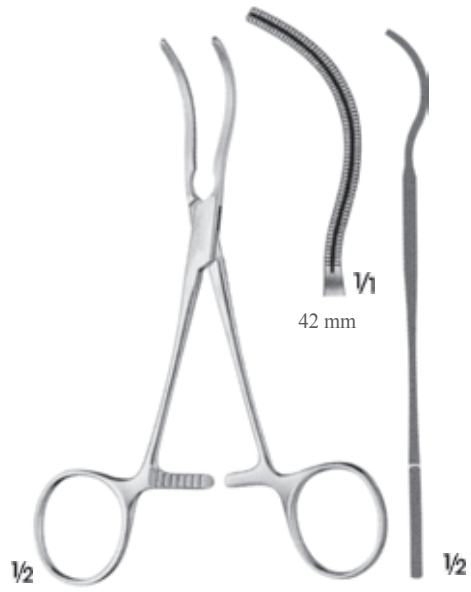
COOLEY  
49-144  
14.5 cm



COOLEY  
49-145 12 cm  
49-146 11.5 cm



COOLEY  
49-147  
14 cm



COOLEY  
49-148  
14.5 cm

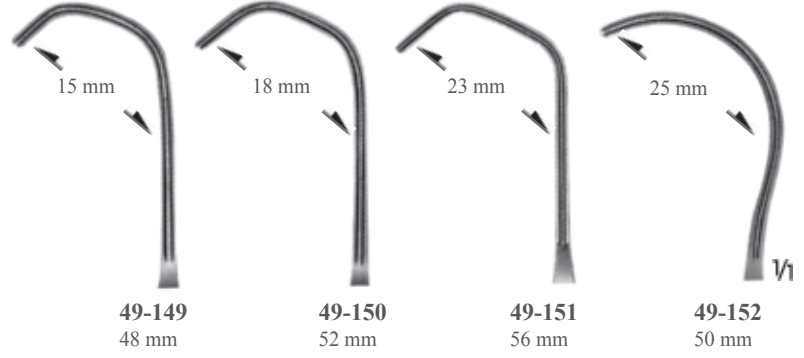
De Bakey Diş



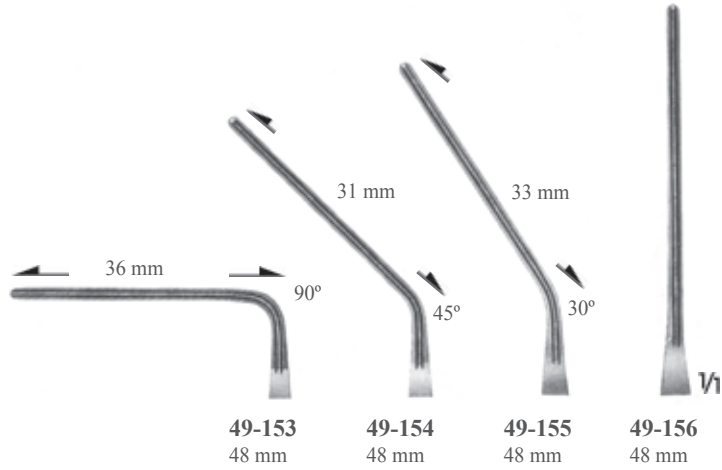
Toothing De BAkey



CASTANEDA  
15.5 cm



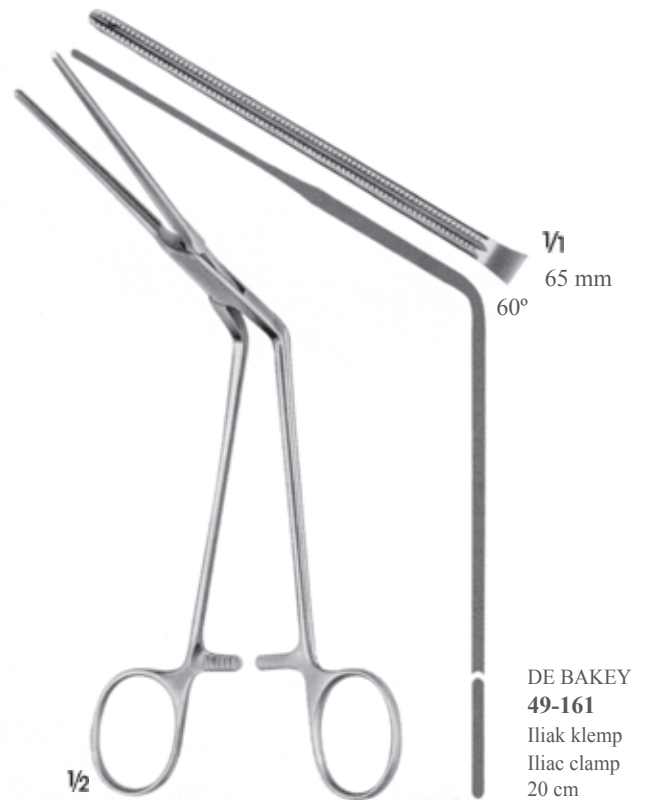
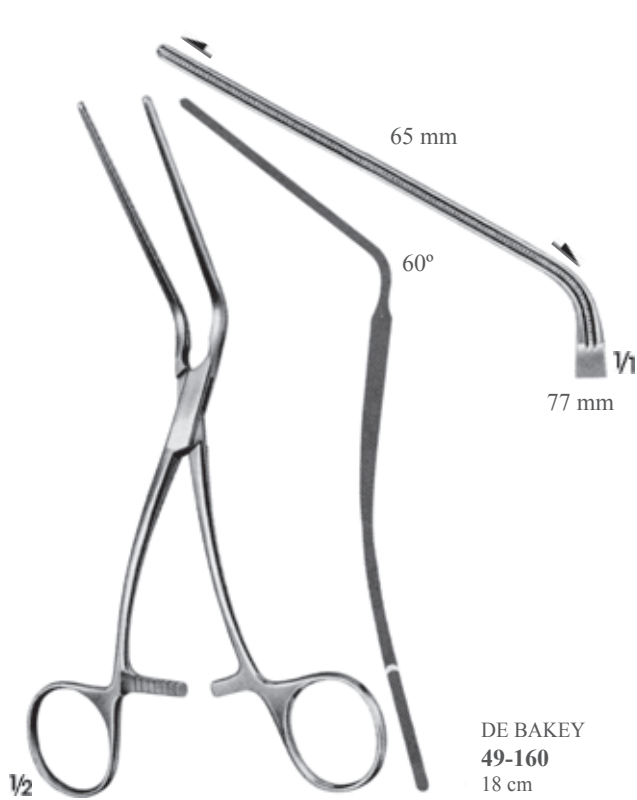
CASTANEDA  
49-153 12.5 cm  
49-154 12 cm  
49-155 12 cm  
49-156 10.5 cm



De Bakey Diş



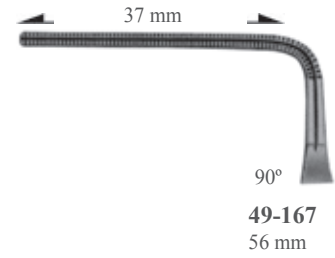
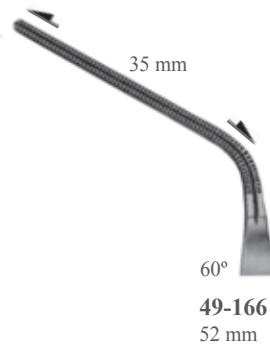
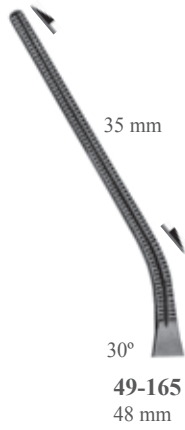
Toothing De BAkey





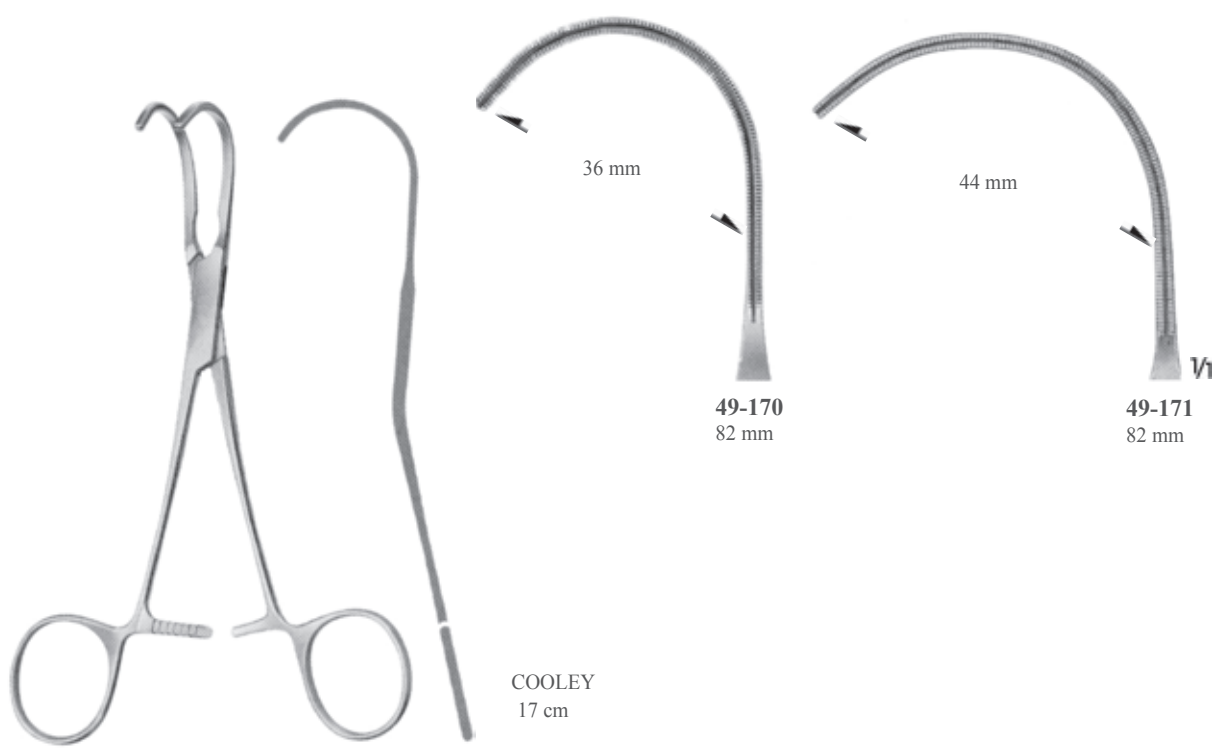
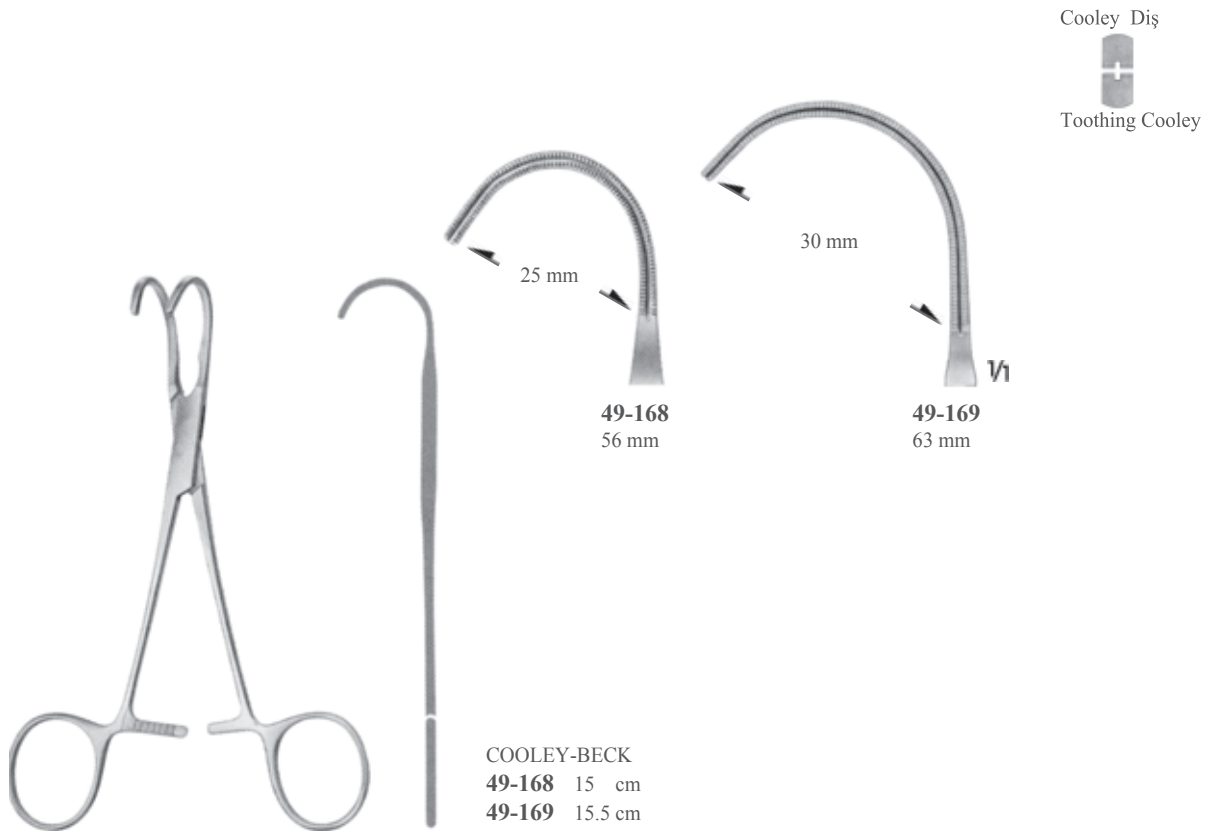
DERRA-COOLEY  
49-162 17cm  
49-163 17.5cm  
49-164 17.5cm  
Anastomoz klempler/  
Anastomosis clamps

Toothing Cooley



COOLEY  
49-165 15 cm  
49-166 16 cm  
49-167 16.5 cm  
Çok amaçlı klempler/Multi Purpose clamps

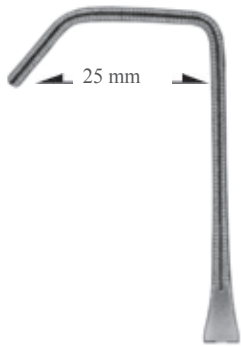




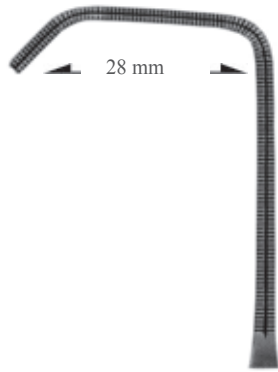
Cooley Diş



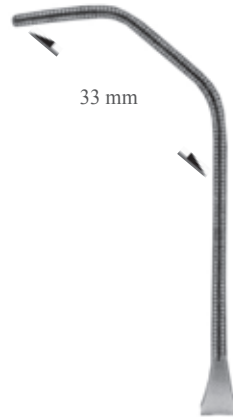
Toothing Cooley



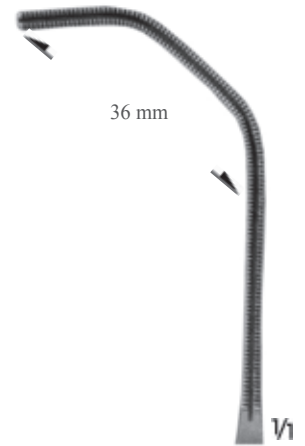
49-172  
72 mm



49-173  
76 mm



49-174  
72 mm



49-175  
76 mm



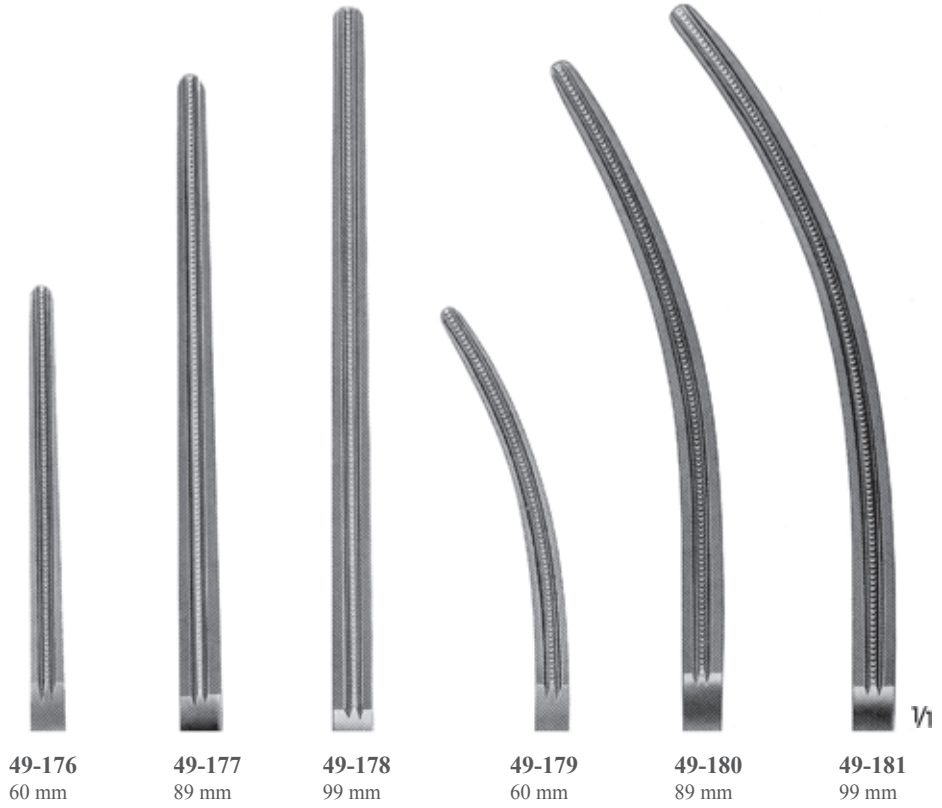
COOLEY	
49-172	16.5 cm
49-173	16.5 cm
49-174	17.5 cm
49-175	18 cm



De Bakey Diş



Toothing De BAkey



**49-176**  
60 mm

**49-177**  
89 mm

**49-178**  
99 mm

**49-179**  
60 mm

**49-180**  
89 mm

**49-181**  
99 mm

DE BAKEY-PEAN

**49-176** 20 cm

**49-177** 26.5 cm

**49-178** 28 cm

DE BAKEY-PEAN

**49-179** 20 cm

**49-180** 26.5 cm

**49-181** 27.5 cm

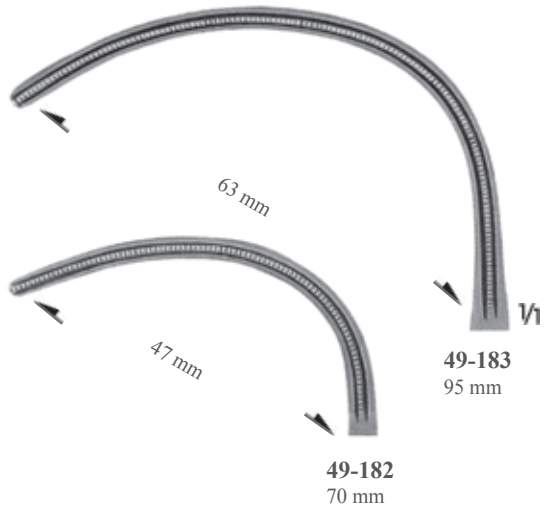
De Bakey Diş



Toothing De BAkey



GLOVER  
49-182 19.5 cm  
49-183 21 cm



49-183  
95 mm

49-182  
70 mm



GLOVER  
49-184  
22 cm



GLOVER  
49-185  
21.5 cm







De Bakey Diş



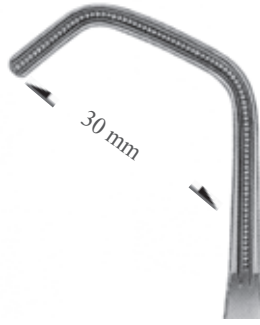
Toothing De BAkey



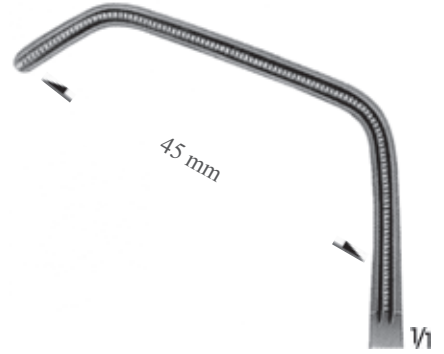
DE BAKEY-BECK

49-186 20.5 cm

49-187 21 cm



49-186  
65 mm



49-187  
80 mm



49-188  
86 mm

49-189  
86 mm

49-190  
86 mm

49-191  
86 mm

DE BAKEY-HARKEN

49-188 25.5 cm

49-189 24.5 cm

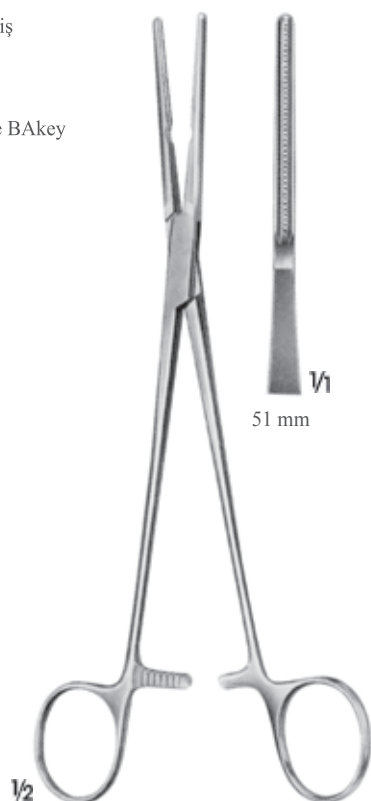
49-190 24.5 cm

49-191 24.5 cm

De Bakey Diş



Toothing De BAkey



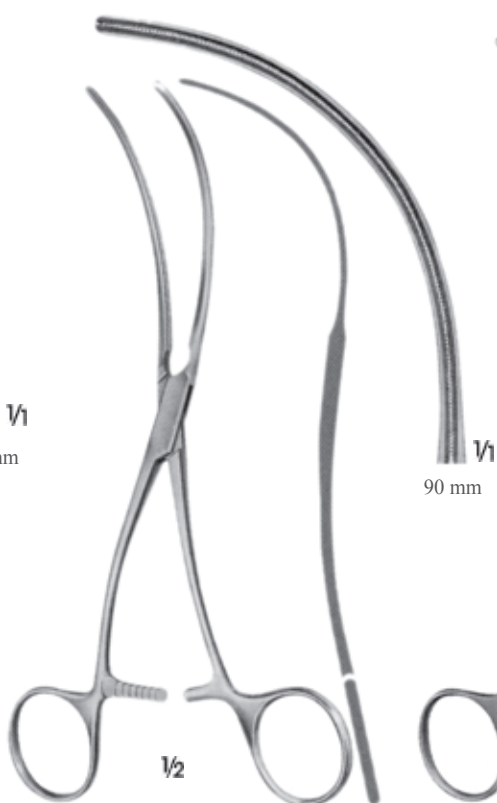
1/2  
DE BAKEY  
49-192  
21 cm



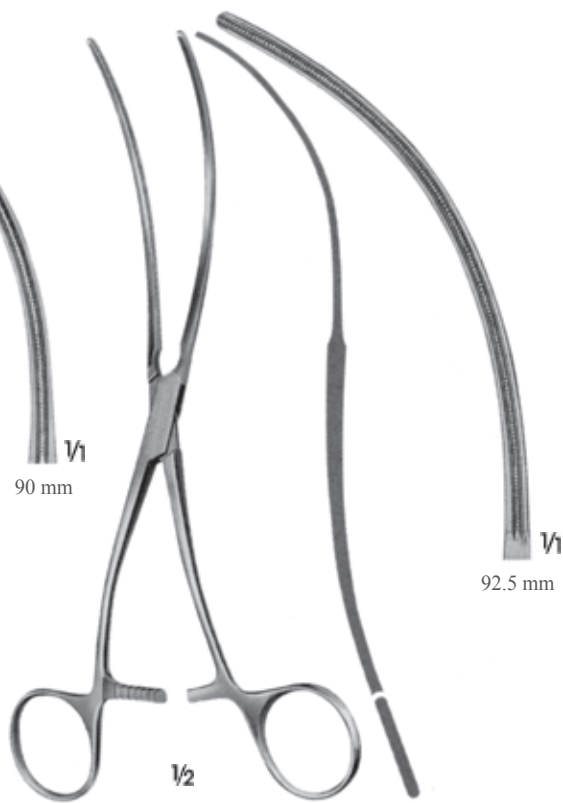
1/2  
DE BAKEY  
49-193  
21 cm



1/2  
DE BAKEY  
49-194  
16 cm

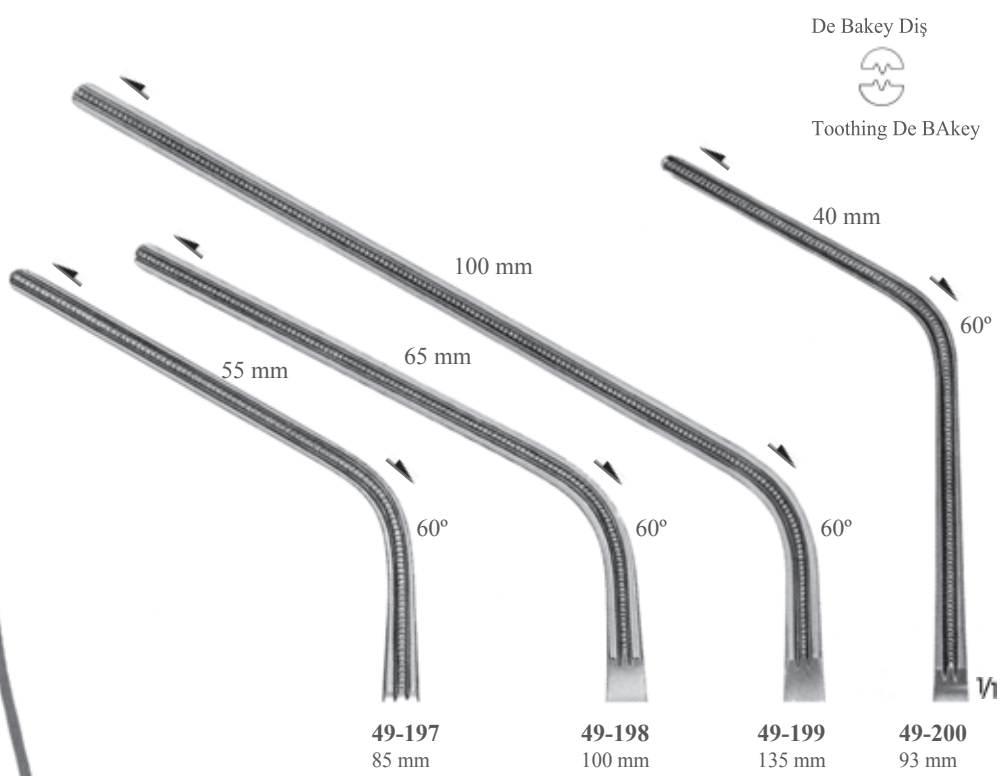


1/2  
DE BAKEY  
49-195  
19 cm



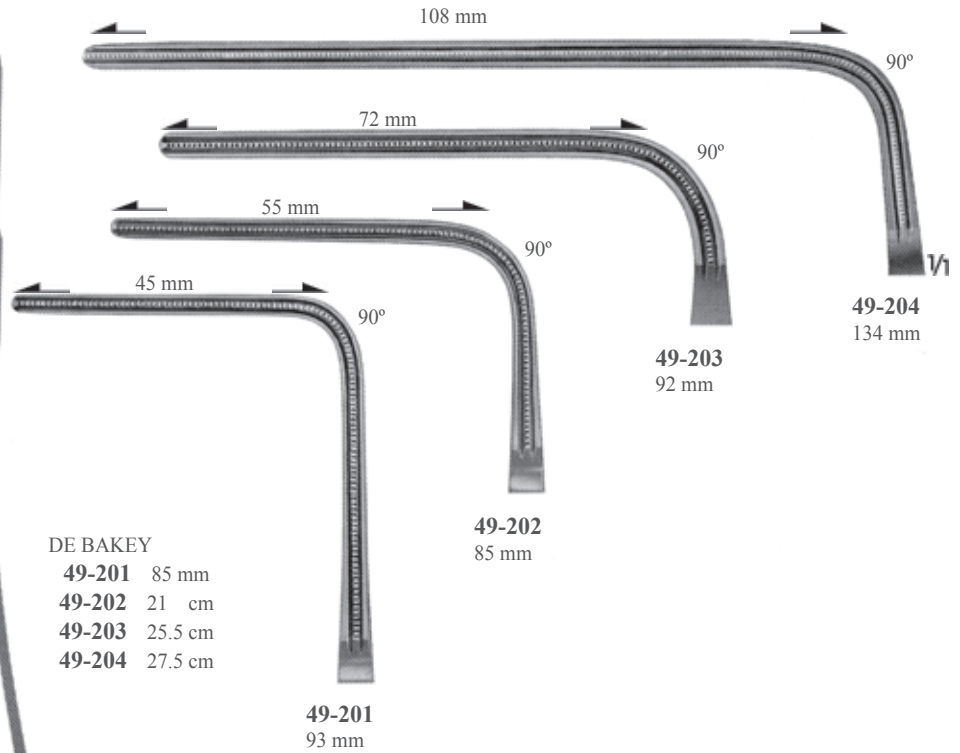
1/2  
DE BAKEY  
49-196  
20 cm





DE BAKEY

49-197	23	cm
49-198	28	cm
49-199	30.5	cm
49-200	24	cm



DE BAKEY

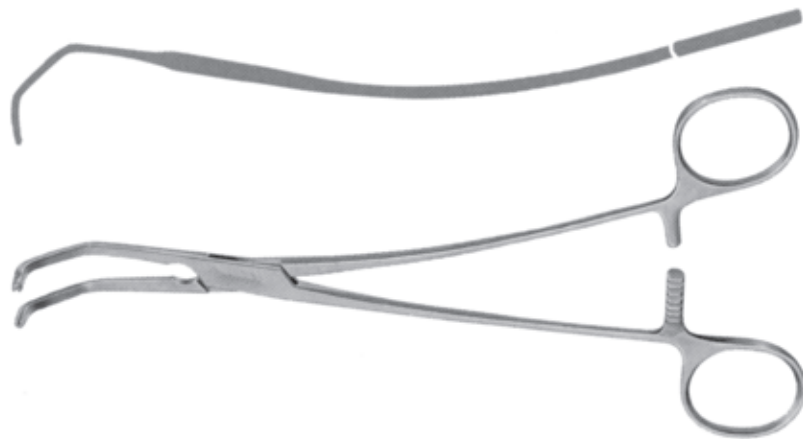
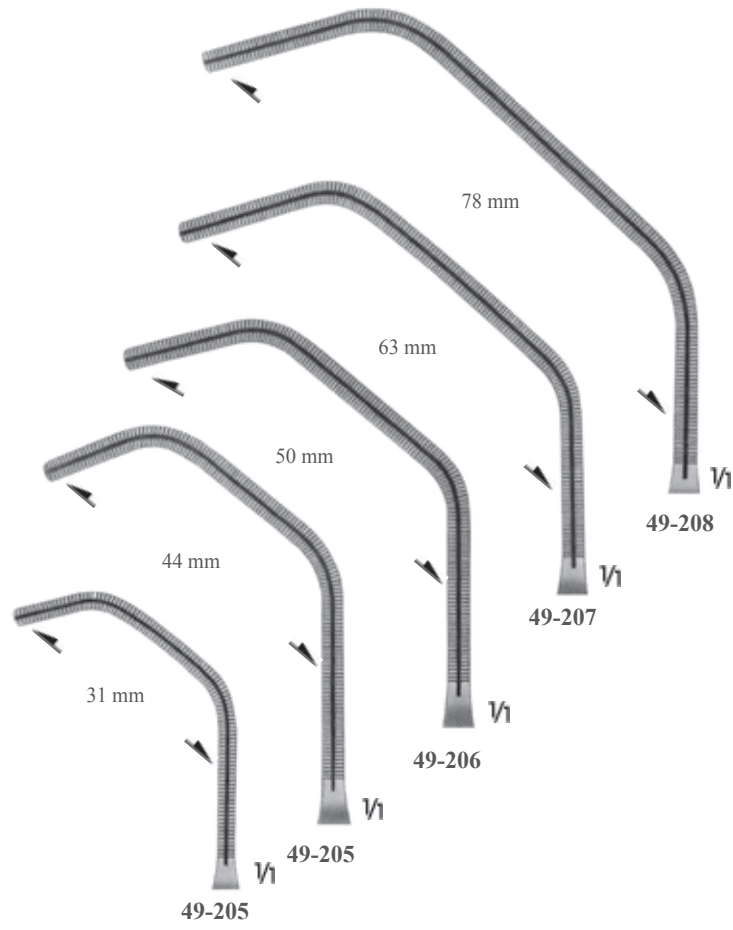
49-201	85	mm
49-202	21	cm
49-203	25.5	cm
49-204	27.5	cm



Cooley Diş



Toothing Cooley



COOLEY

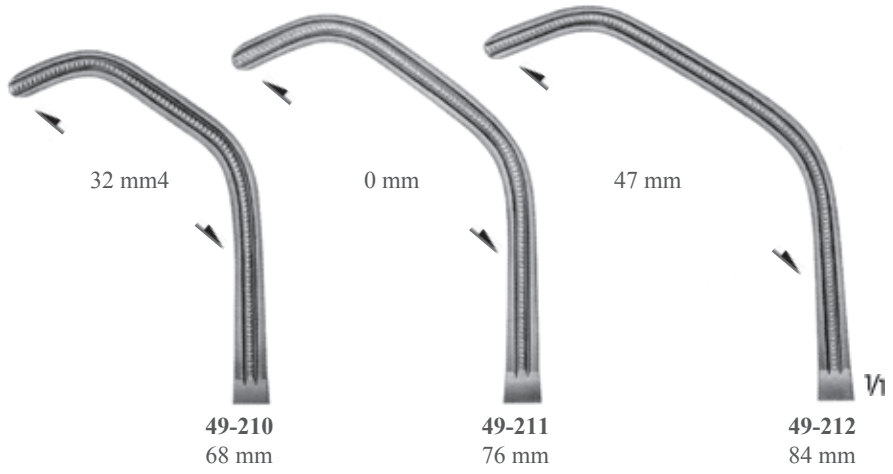
<b>49-205</b>	20.5 cm
<b>49-206</b>	26 cm
<b>49-207</b>	26.5 cm
<b>49-208</b>	26.5 cm
<b>49-209</b>	27.5 cm

1/2

De Bakey Diş

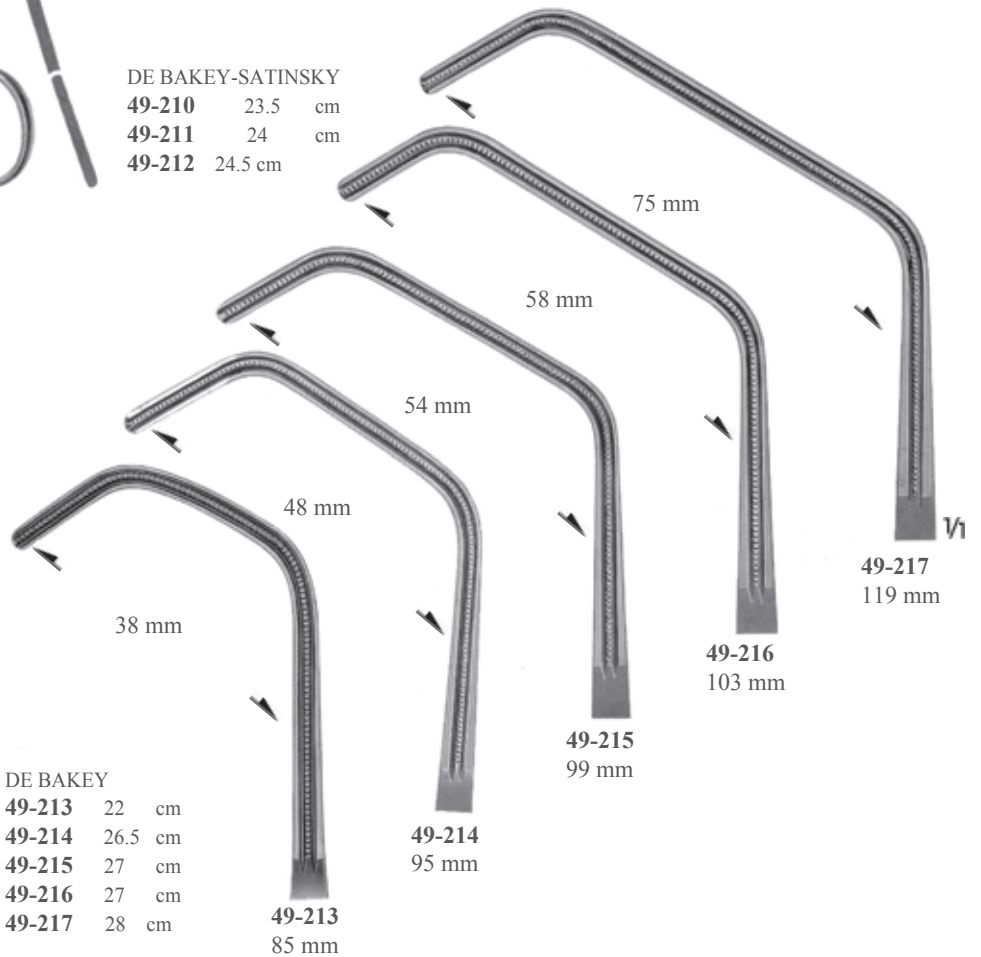


Toothing De BAkey



DE BAKEY-SATINSKY

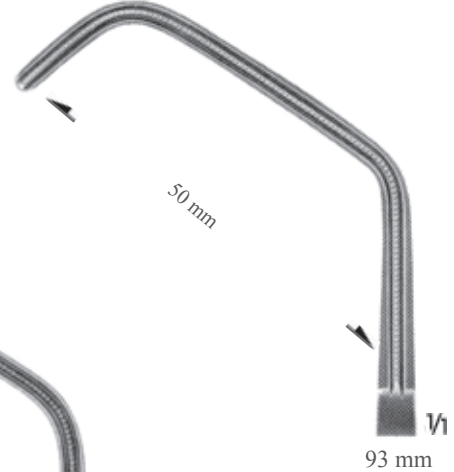
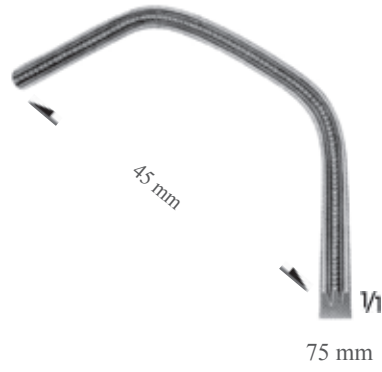
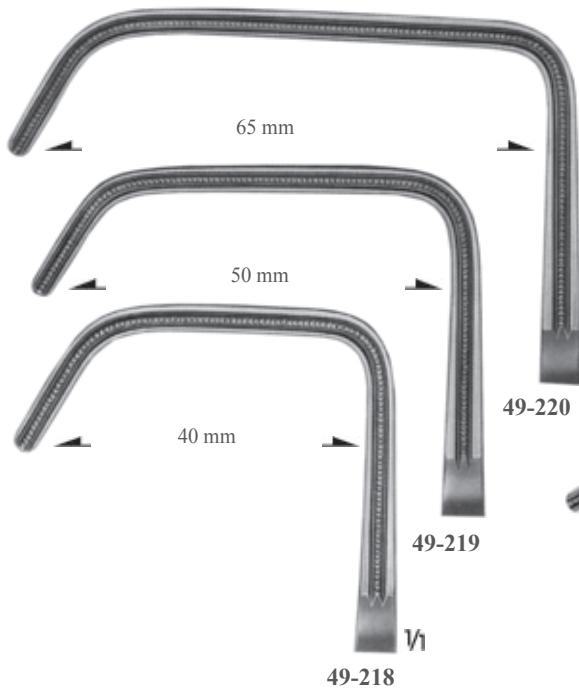
49-210	23.5	cm
49-211	24	cm
49-212	24.5	cm



DE BAKEY

49-213	22	cm
49-214	26.5	cm
49-215	27	cm
49-216	27	cm
49-217	28	cm





De Bakey Diş



Toothing De BAkey



HOPT  
49-218 23 cm  
49-219 23.5 cm  
49-220 24.5 cm Böbrek ve  
Pankreas klempleri Kidney  
and Pankreas clamps



DIETRICH  
49-221  
Aort klem/Aorta clamp  
21 cm



OCHSNER  
49-222  
Aort klem/Aorta clamp  
26 cm



De Bakey Diş

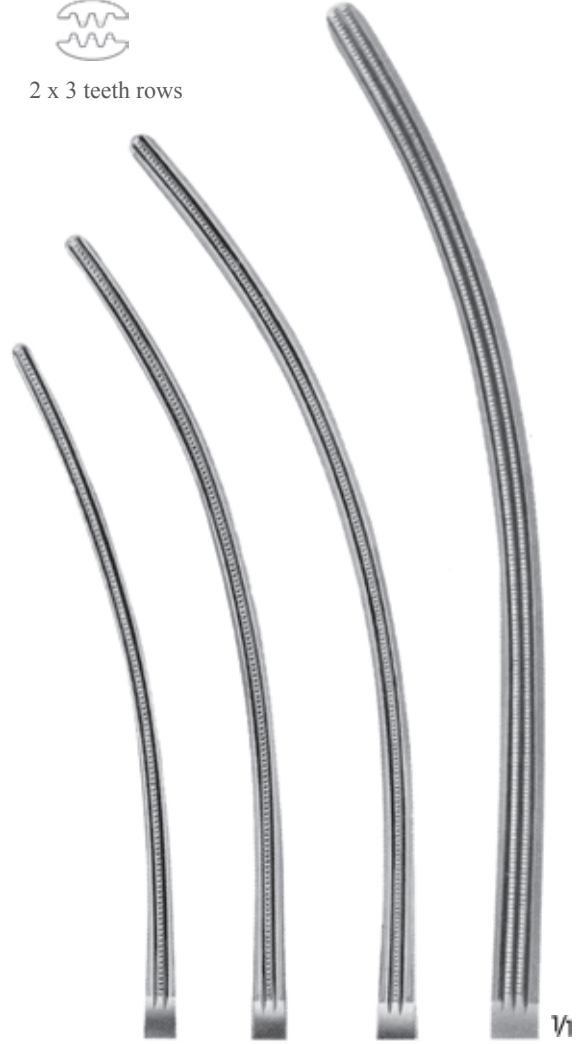


Toothing De BAkey

2 x 3 sıra diş



2 x 3 teeth rows

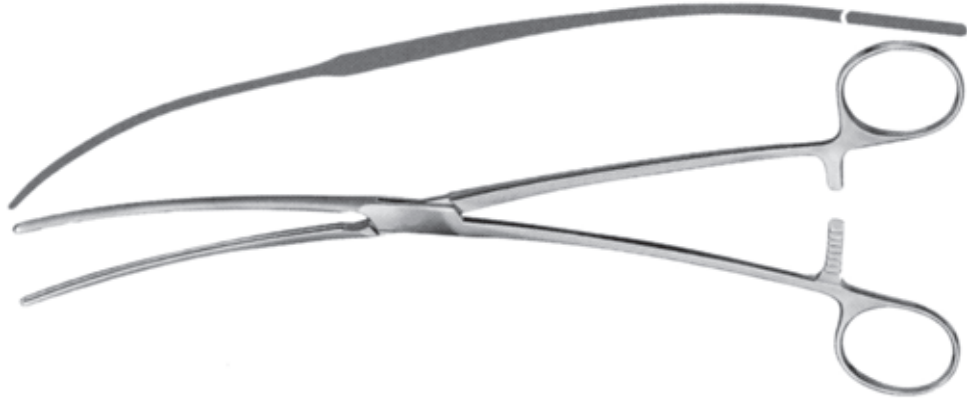


49-223  
95 mm

49-224  
110 mm

49-225  
130 mm

49-226  
140 mm



DE BAKEY

49-223 25 cm

49-224 30 cm

49-225 31.5 cm

49-226 33 cm





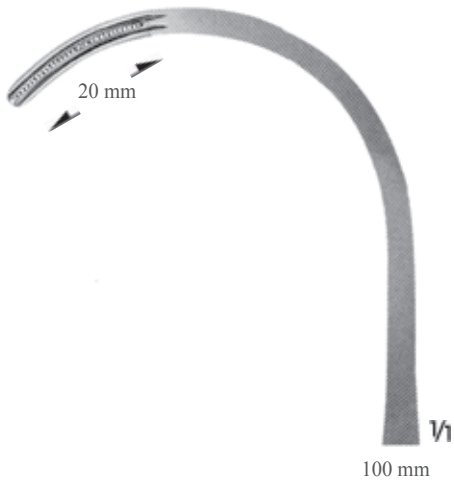
CALNE  
27 cm  
49-227



De Bakey Diş



Toothing De BAkey



DE BAKEY  
49-228  
26.5 cm



DE BAKEY  
49-229  
27 cm





De Bakey Diş



Toothing De BAkey



1/2

DE BAKEY  
49-230  
30 cm



1/1  
115 mm



T18-123  
70 mm

T18-124  
75 mm

T18-125  
85 mm

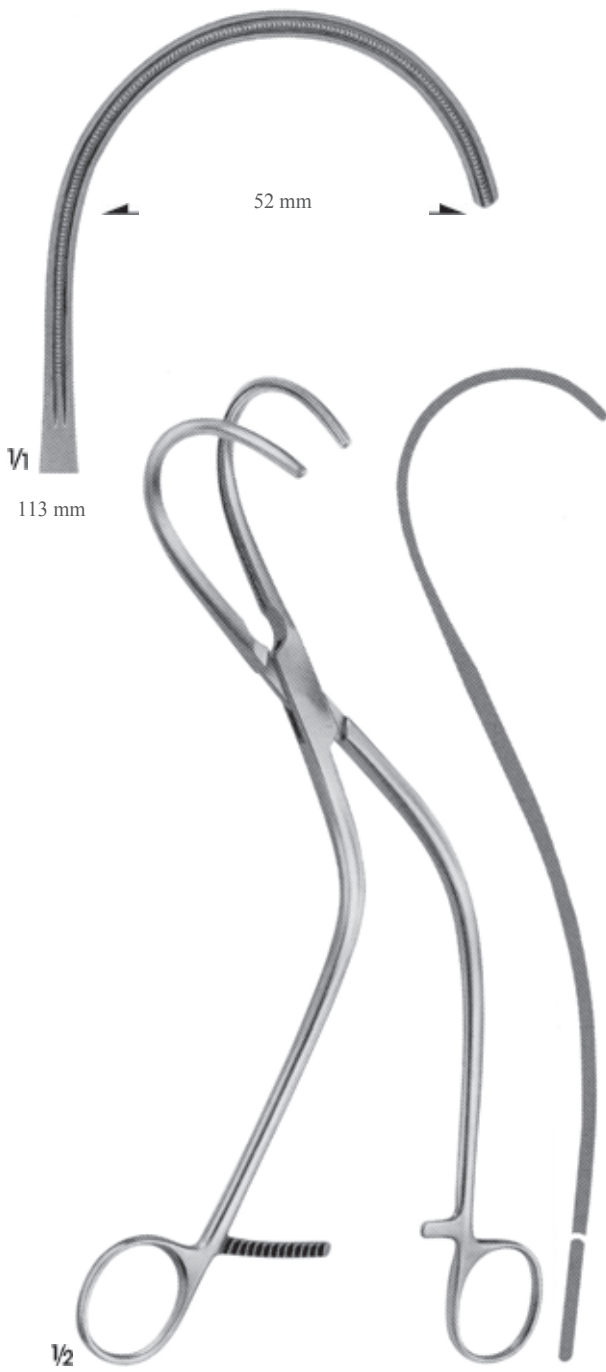


DE BAKEY  
49-231 25.5 cm  
49-232 26.5 cm  
49-233 28 cm

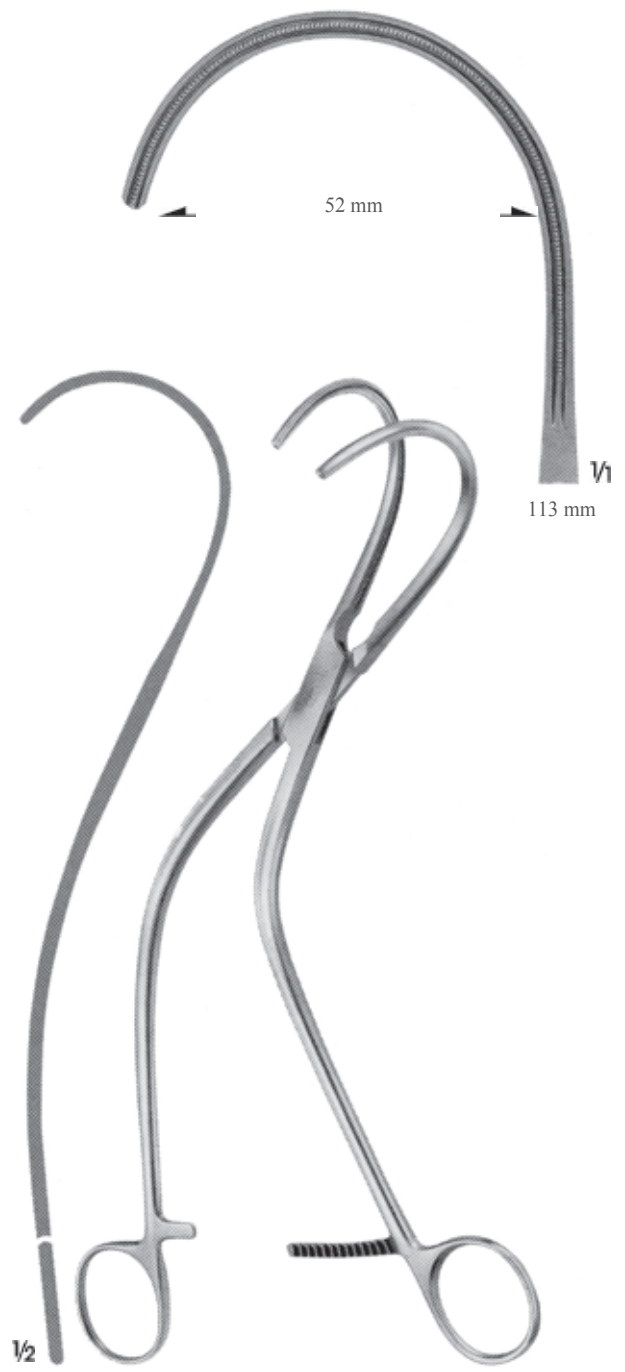
De Bakey Diş



Toothing De BAkey



WEBER  
49-234  
Sol/Left  
26 cm



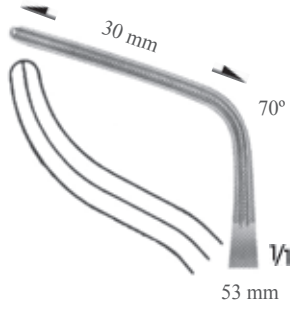
WEBER  
49-235  
Sağ/Right  
26 cm



De Bakey Diş

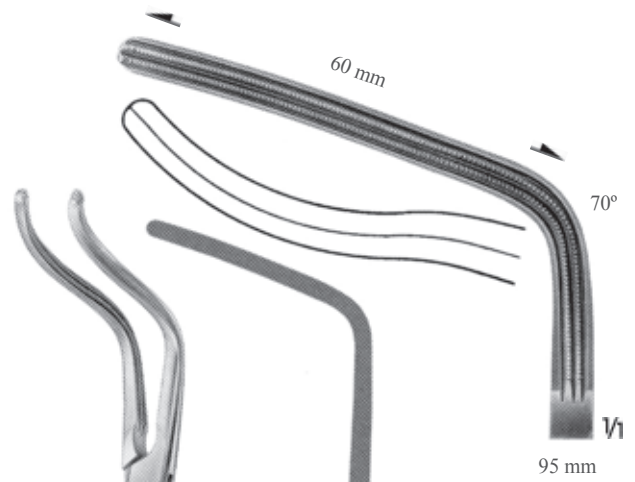


Toothing De BAkey



1/2

SUBRAMANIAN  
49-236  
15.5 cm



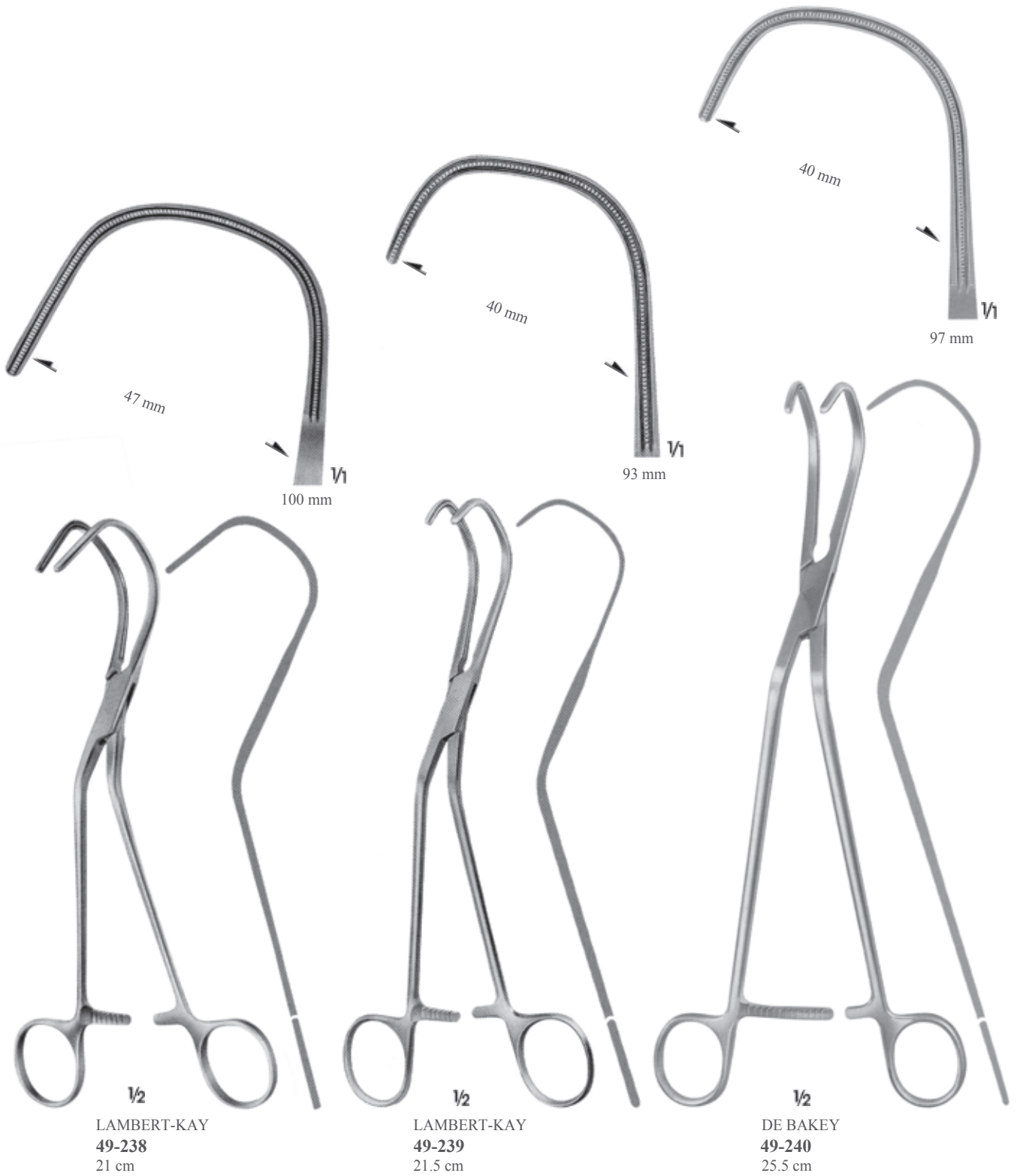
1/2

DE BAKEY  
49-237  
26.5 cm

De Bakey Diş



Toothing De BAkey





De Bakey Diş



Toothed De BAkey



49-241  
51 mm



49-242  
75 mm

DE BAKEY  
49-241 21 cm  
49-242 23 cm



49-243  
77 mm

DE BAKEY  
49-243 19 cm



1/2

DE BAKEY  
49-244  
24 cm



1/1  
94 mm

De Bakey Diş



Toothing De BAkey



81 mm



80 mm



81 mm



1/2

DE BAKEY-RUMEL  
49-245  
24.5 cm



1/2

DE BAKEY-MIXTER  
49-246  
28.5 cm



1/2

DE BAKEY-RUMEL  
49-247  
25 cm



De Bakey Diş



Toothing De BAkey



DE BAKEY-MC QUIGG-MIXTER  
49-248  
21 cm



LEES  
49-249  
22 cm



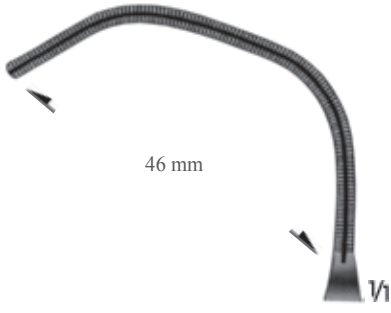
LEES  
49-250  
24.5 cm



Cooley Diş



Toothing Cooley



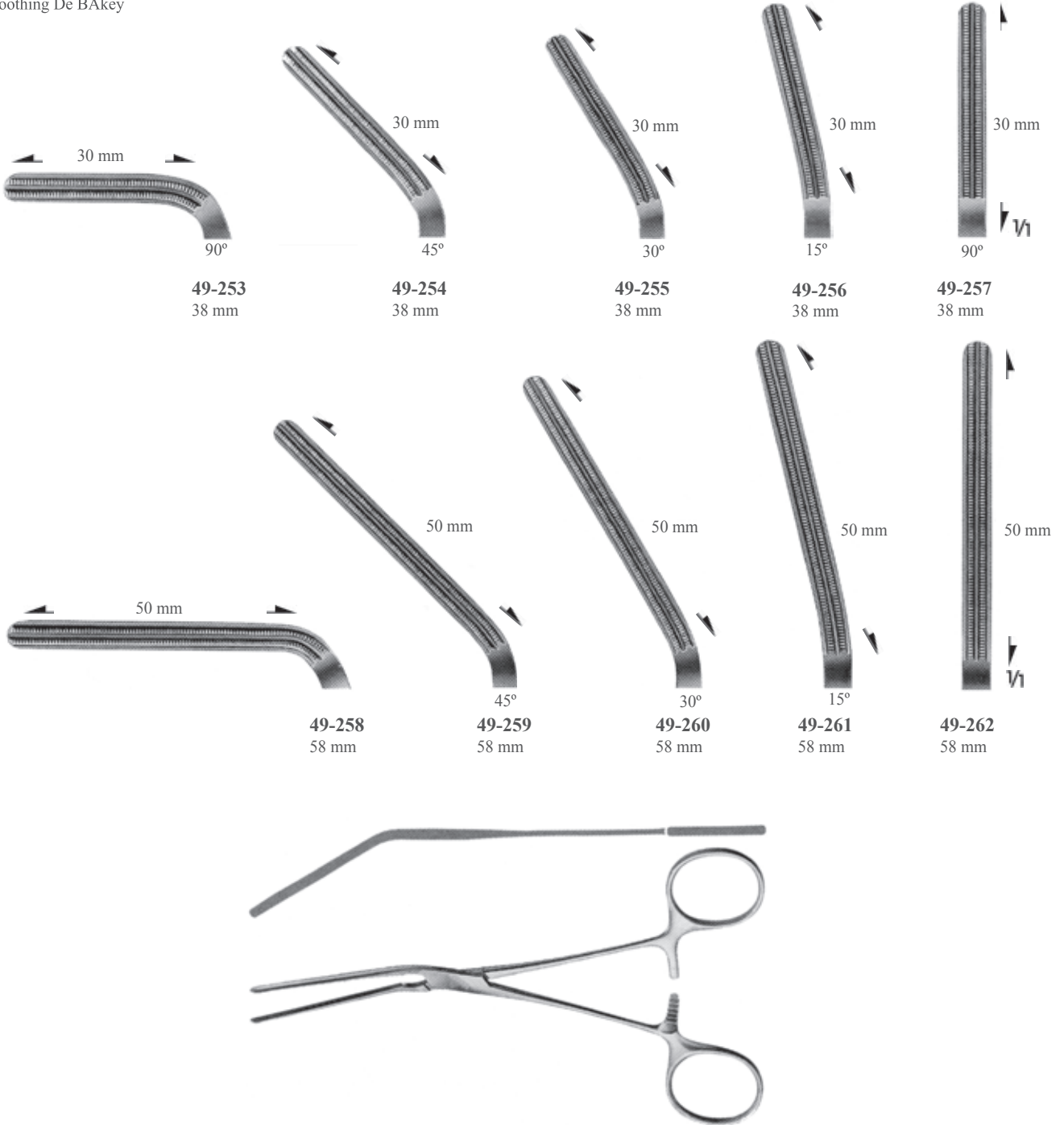
COOLEY  
49-251  
22 cm

COOLEY  
49-252  
28.5 cm

De Bakey Diş  
2 x 3 sıra diş



2 x 3 teeth rows  
Toothing De BAkey



DARDIK

49-253 13 cm  
49-254 14.5 cm  
49-255 15 cm  
49-256 15 cm  
49-257 15 cm

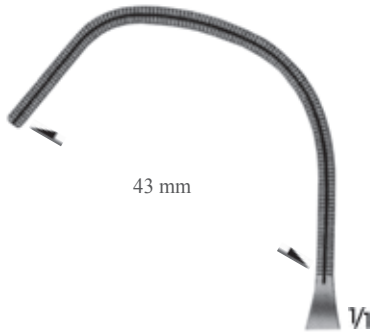
DARDIK

49-258 13.5 cm  
49-259 16 cm  
49-260 17 cm  
49-261 17 cm  
49-262 17 cm

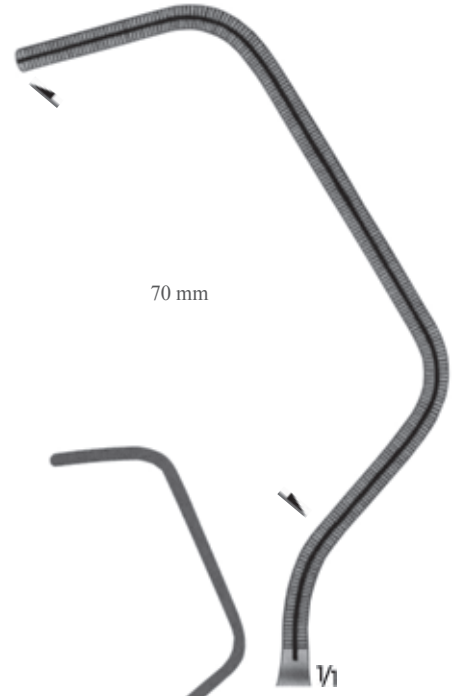
Cooley Diş



Toothing Cooley



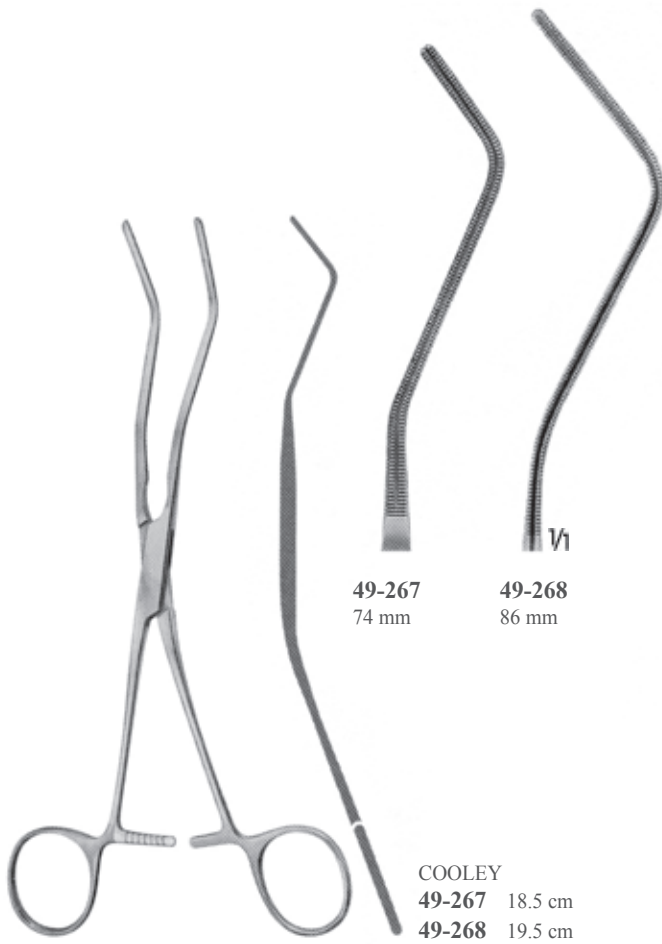
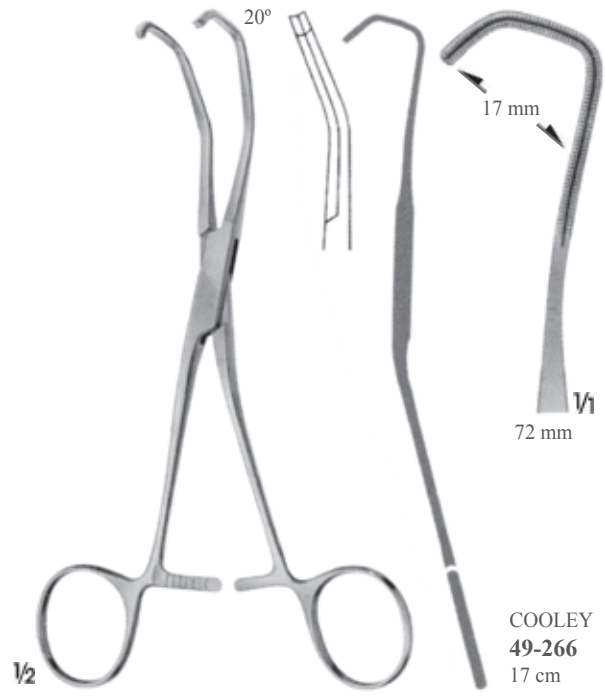
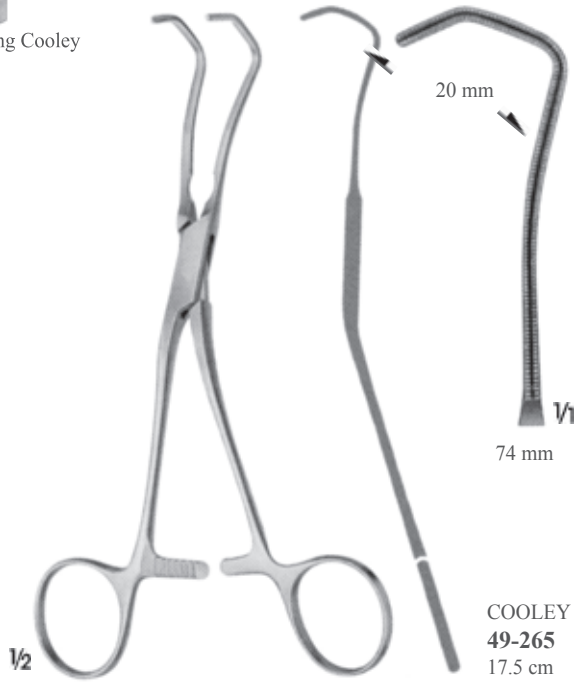
LEITZ  
49-263  
20.5 cm



PARRY-COOLEY  
49-264  
29.5 cm



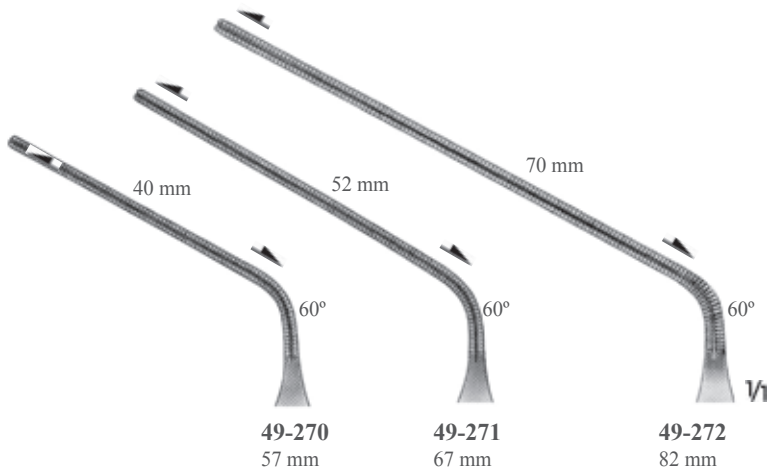
Cooley Diş  
Toothing Cooley



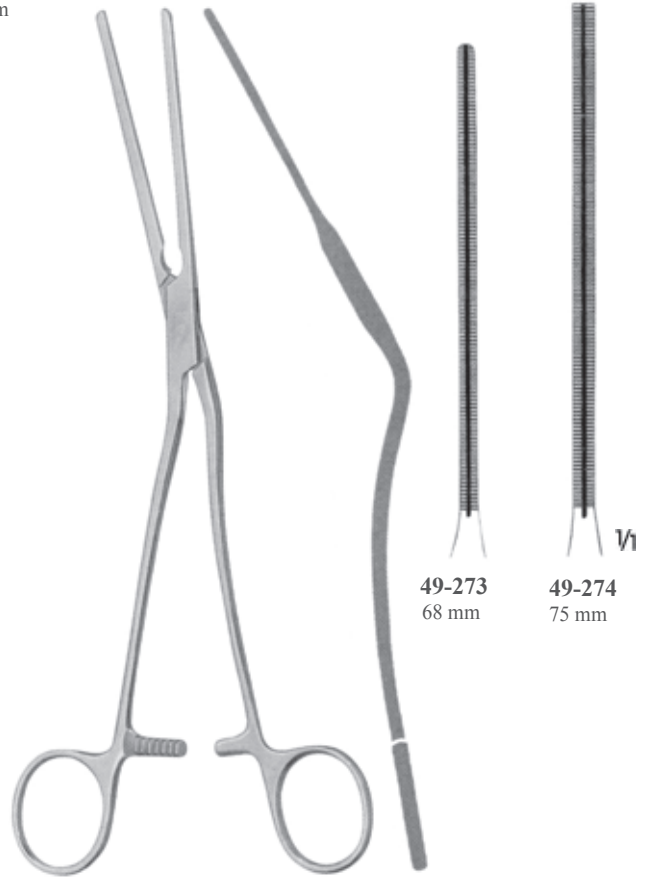
Cooley Diş



Toothing Cooley



**49-270** 16.5 cm  
**49-271** 17 cm  
**49-272** 18.5 cm



**49-273** 22.5 cm  
**49-274** 27 cm

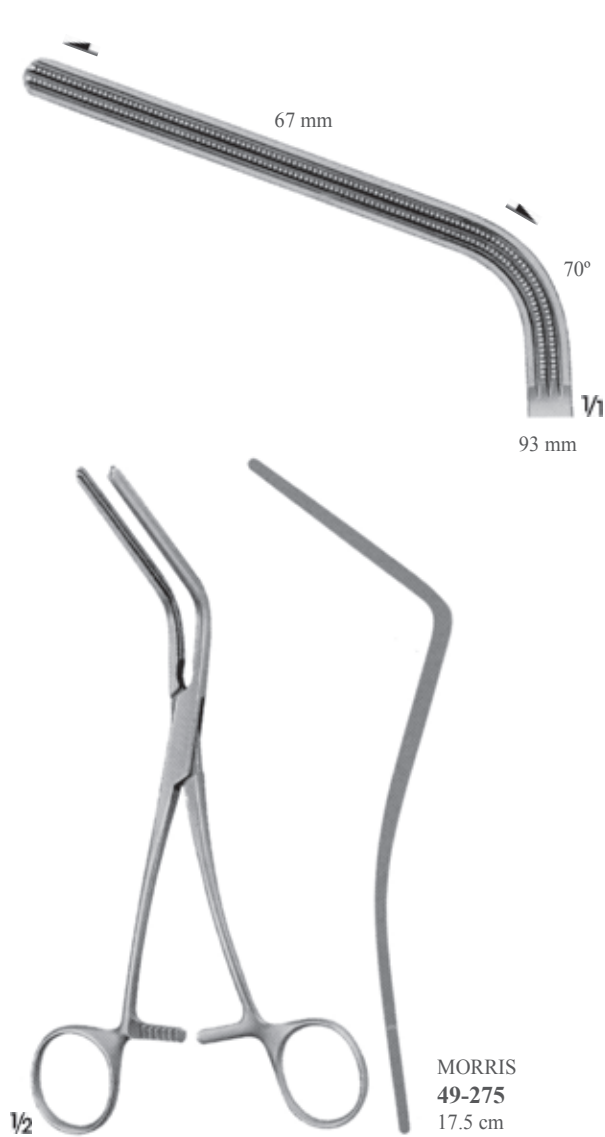
**49-273**  
68 mm

**49-274**  
75 mm

Cooley Diş



Toothing Cooley



Cooley Diş



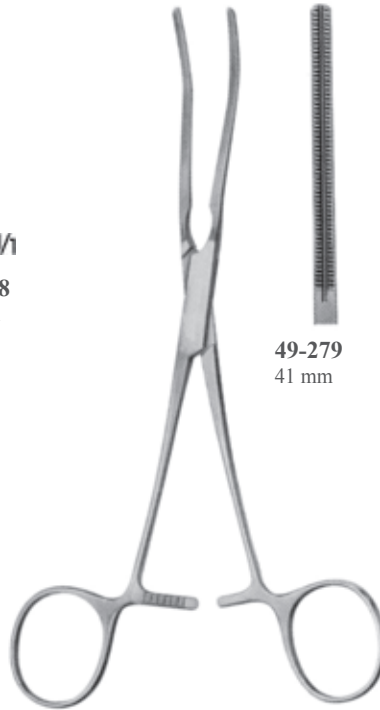
Toothing Cooley



49-277  
41 mm



49-278  
52 mm



49-279  
41 mm

49-280  
52 mm

49-281  
52 mm

49-282  
63 mm

COOLEY  
49-277 16 cm  
49-278 17 cm

COOLEY  
49-279 16 cm  
49-280 17 cm  
49-281 18 cm  
49-282 18 cm



Cooley Diş



Toothing Cooley



115 mm

1/2

1/1

COOLEY  
49-283  
32 cm



De Bakey Diş



Toothing De BAkey



49-284  
60 mm



49-285  
80 mm



49-286  
78 mm

49-287  
88 mm

49-288  
98 mm



Bronş pensler  
Bronchus forceps  
23 cm



DICK  
49-286 25.5 cm  
49-287 26.5 cm  
49-288 27.5 cm  
Anastomoz klempler  
Anastomosis clamps



**50**



15 cm

<b>50-100</b>	2 mm		$\frac{1}{1}$
<b>50-101</b>	3 mm		$\frac{1}{1}$
<b>50-102</b>	4 mm		$\frac{1}{1}$
<b>50-103</b>	5 mm		$\frac{1}{1}$

CASPAR  $\frac{1}{2}$

15 cm

<b>50-104</b>	2 mm		$\frac{1}{1}$
<b>50-105</b>	3 mm		$\frac{1}{1}$
<b>50-106</b>	4 mm		$\frac{1}{1}$

CASPAR

150°

15 cm

<b>50-107</b>	2 mm		$\frac{1}{1}$
<b>50-108</b>	3 mm		$\frac{1}{1}$
<b>50-109</b>	4 mm		$\frac{1}{1}$

CASPAR  $\frac{1}{2}$

Alt çene hareketli  
Lower part of jaw movable

150°



CUSHING

50-110 4 mm



V1

50-111 5 mm

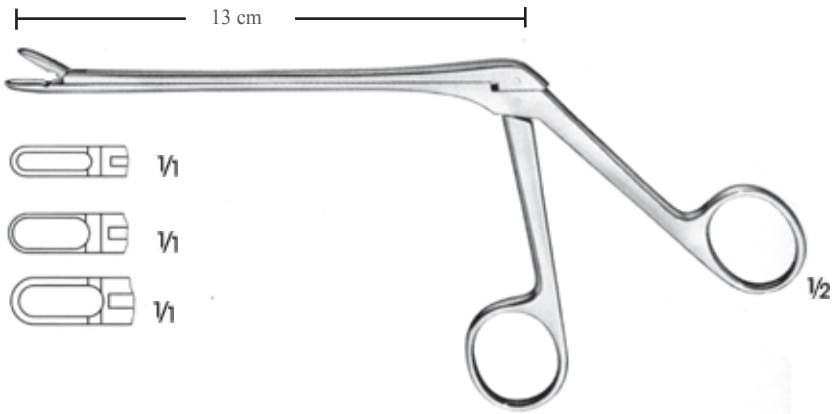


V1

50-112 6 mm



V1



CUSHING

50-113 3 mm



V1

50-114 4 mm



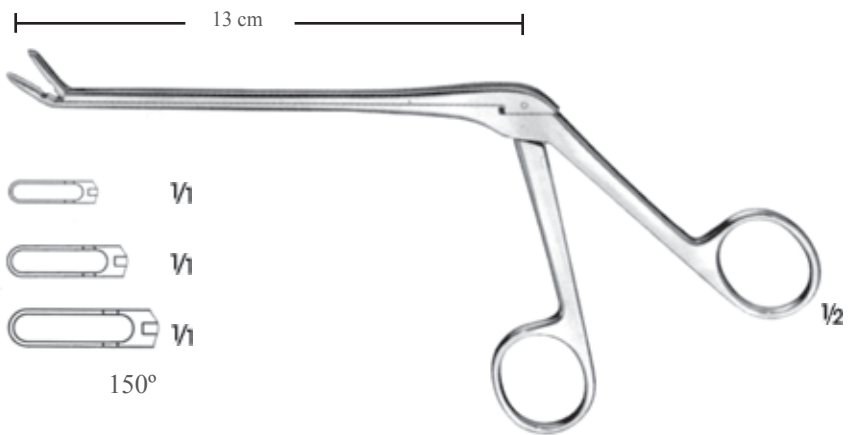
V1

50-115 5 mm



V1

150°



CUSHING

50-116 3 mm



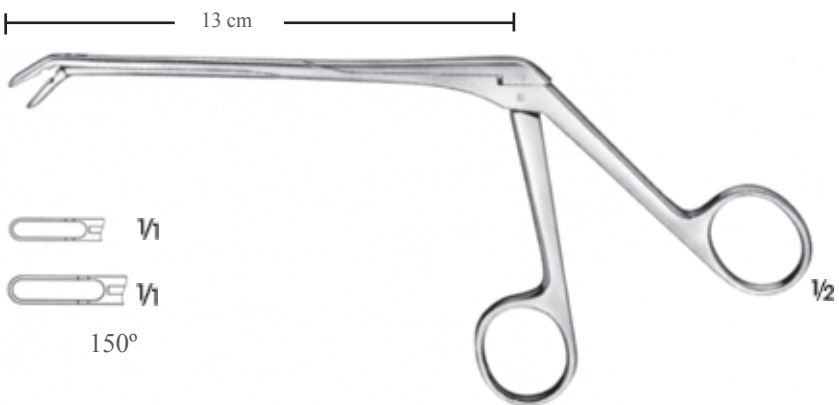
V1

50-117 4 mm



V1

150°



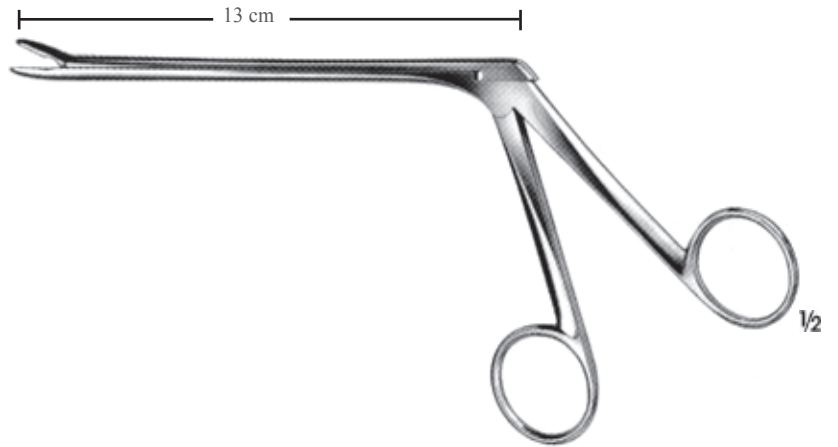
LOVE-GRUENWALD  
50-118 2 x 10 mm



LOVE-GRUENWALD  
50-119 3 x 10 mm



SPURLING  
50-120 4 x 10 mm



CUSHING  
50-121 2 x 10 mm



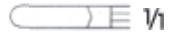
LOVE-GRUENWALD  
50-122 3 x 10 mm



SPURLING  
50-123 4 x 10 mm



LOVE-GRUENWALD  
50-124 3 x 10 mm



SPURLING  
50-125 4 x 10 mm



150°



Üst çene hareketli  
Upper part of jaw movable

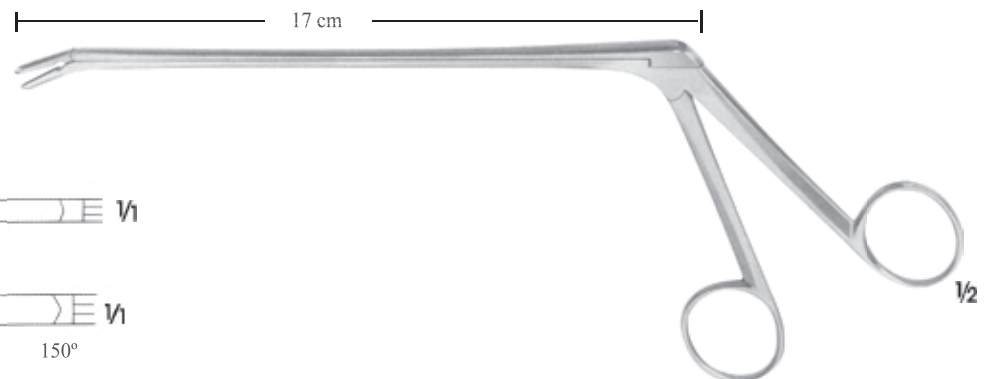
LOVE-GRUENWALD  
50-126 3 x 10 mm



LOVE-GRUENWALD  
50-127 4 x 10 mm



150°



Alt çene hareketli  
Upper part of jaw movable

Mil uzunluğu  
Length of shaft  
14 cm

**50-128**

Mil uzunluğu  
Length of shaft  
16 cm

**50-130**

Mil uzunluğu  
Length of shaft  
18.5 cm

**50-133**

Çene Ölçüleri  
Size of jaws

3 x 12 mm



**50-129**

**50-131**

**50-134**

4 x 14 mm



150°

CASPAR

Mil uzunluğu  
Length of shaft  
14 cm

**50-135**

**50-136**

**50-137**

**50-138**

**50-139**

Mil uzunluğu  
Length of shaft  
16 cm

**50-140**

**50-141**

**50-142**

**50-143**

**50-144**

Mil uzunluğu  
Length of shaft  
18.5 cm

**50-145**

**50-146**

**50-147**

**50-148**

**50-149**

Çene ölçüleri  
Size of jaws

2 x 12 mm

3 x 12 mm

4 x 14 mm

5 x 14 mm

6 x 16 mm



CASPAR

Mil uzunluğu  
Length of shaft  
14 cm

**50-150**

**50-151**

**50-152**

Mil uzunluğu  
Length of shaft  
16 cm

**50-153**

**50-154**

**50-155**

Mil uzunluğu  
Length of shaft  
18.5 cm

**50-156**

**50-157**

**50-158**

Çene ölçüleri  
Size of jaws

3 x 12 mm

4 x 14 mm

5 x 14 mm

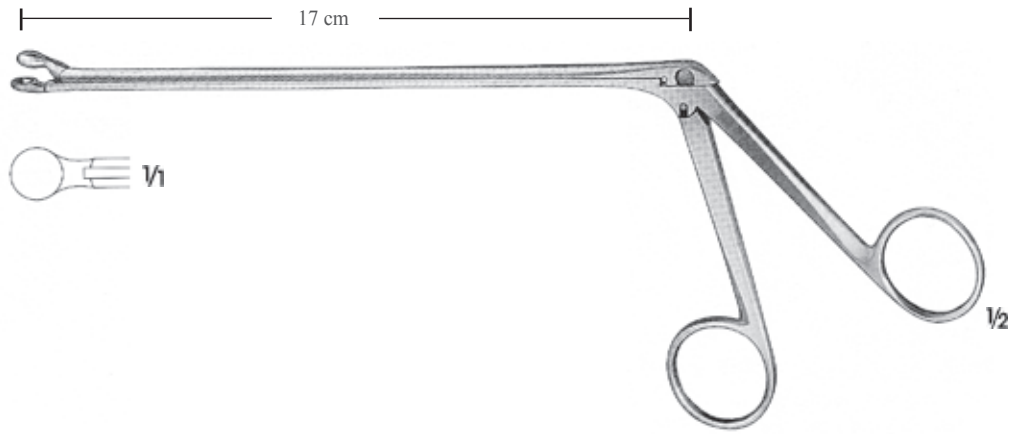


150°

CASPAR

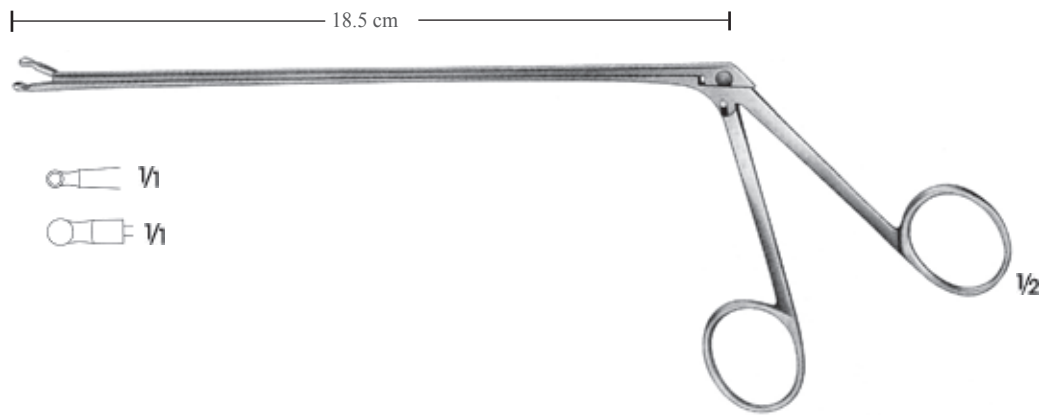


OLDBERG  
50-159 Ø 7 mm

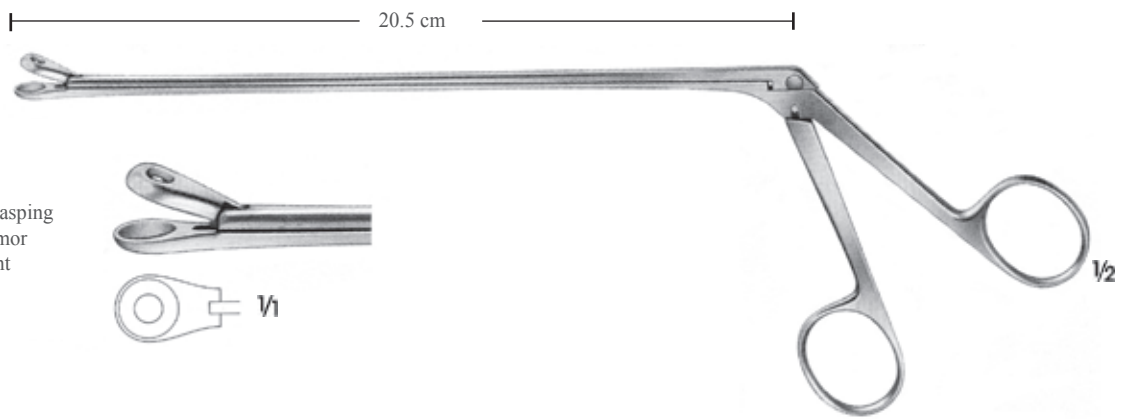


YASARGIL  
50-160 Ø 2.2 mm

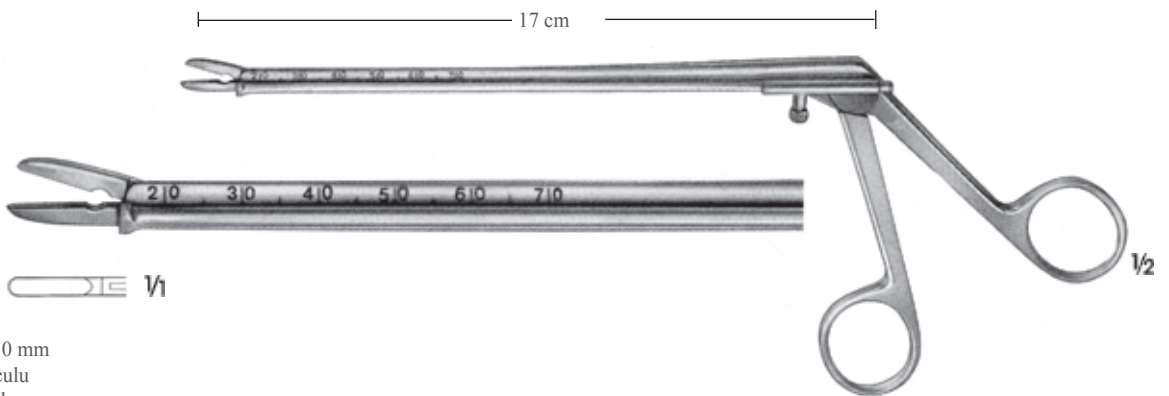
50-161 Ø 3.5 mm



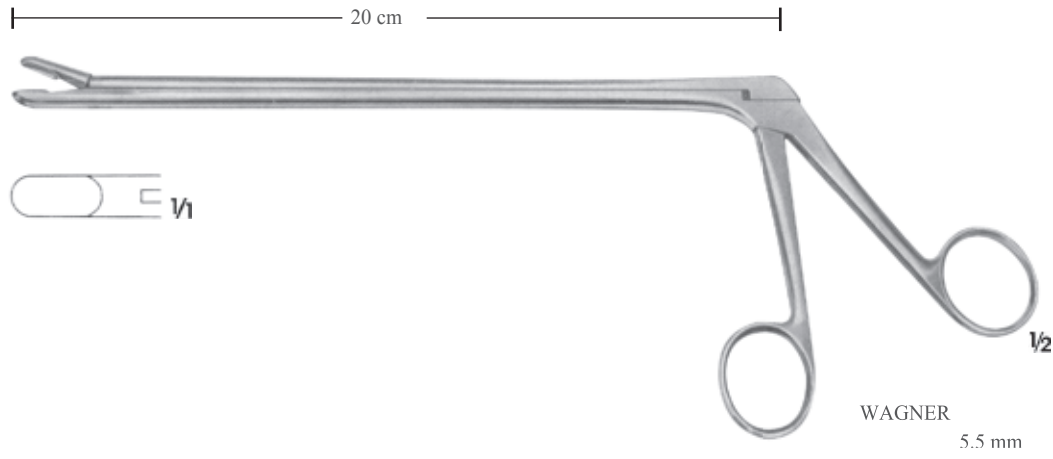
LANDOLT  
50-162 Ø 9 mm Grasping  
tümör pensı, künt Tumor  
grasping forceps, blunt



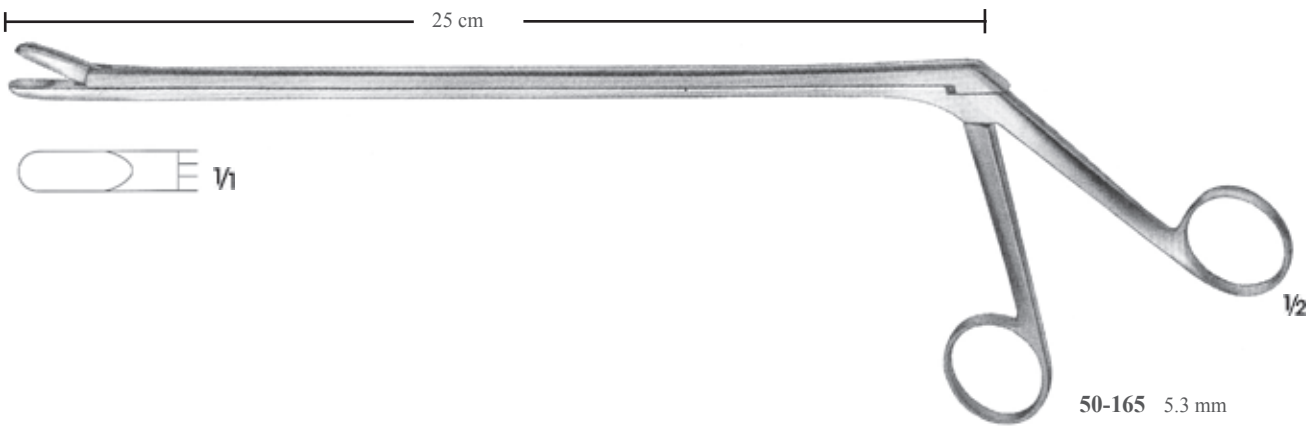
KRAMER  
50-163 2.5 x 10 mm  
Derinlik koruyuculu  
With depth guard



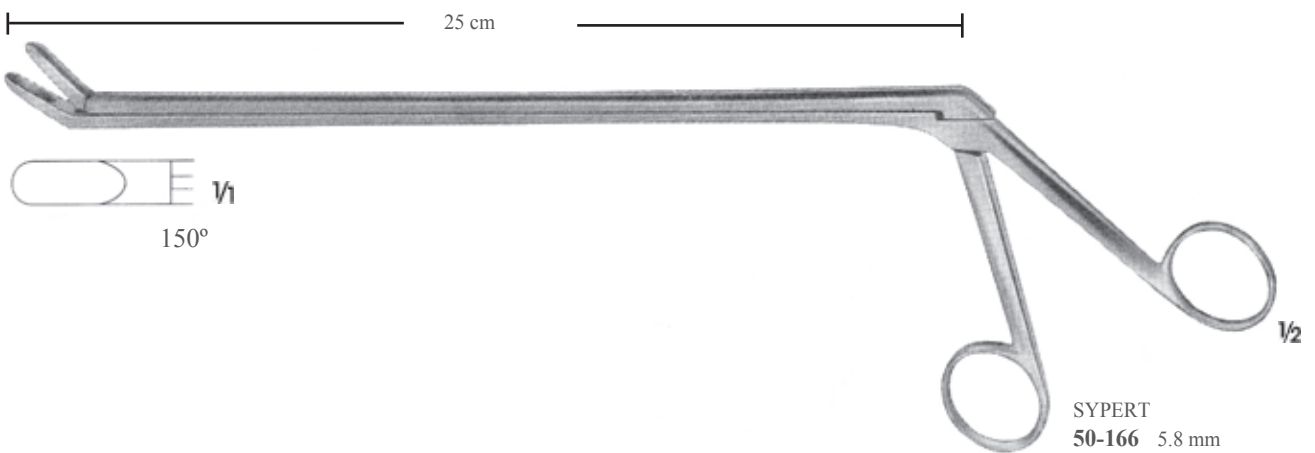




WAGNER  
**5.5mm**  
50-164



50-165 5.3 mm



SYPERT  
**50-166** 5.8 mm

90° Yukarıya doğru kesme/Upwards cutting



Standart ağız tabanlı  
Standard footplate














HardCoated















Standart ağız tabanlı  
Standard footplate



Standart ağız tabanlı  
Standard footplate

Boy Length	En Widht	Ejektör Ejector	Ayrılabilir/Detachable		Standart/Standard	
						
18 cm	1 mm		-	<b>50-167</b>	<b>50-177</b>	<b>50-187</b>
18 cm	2 mm		-	<b>50-168</b>	<b>50-178</b>	<b>50-188</b>
18 cm	3 mm		+	<b>50-169</b>	<b>50-179</b>	<b>50-189</b>
18 cm	4 mm		+	<b>50-170</b>	<b>50-180</b>	<b>50-190</b>
18 cm	5 mm		+	<b>50-171</b>	<b>50-181</b>	<b>50-191</b>
18 cm	6 mm		+	<b>50-172</b>	<b>50-182</b>	<b>50-192</b>
23 cm	2 mm		-	<b>50-173</b>	<b>50-183</b>	<b>50-193</b>
23 cm	3 mm		+	<b>50-174</b>	<b>50-184</b>	<b>50-194</b>
23 cm	4 mm		+	<b>50-175</b>	<b>50-185</b>	<b>50-195</b>
23 cm	5 mm		+	<b>50-176</b>	<b>50-186</b>	<b>50-196</b>

90° Aşağıya doğru kesme/Downwards cutting

Boy Length	En Widht	Ejektör Ejector	Ayrılabilir/Detachable		Standart/Standard	
						
18 cm	1 mm		-	<b>50-197</b>	<b>50-207</b>	
18 cm	2 mm		-	<b>50-198</b>	<b>50-208</b>	
18 cm	3 mm		+	<b>50-199</b>	<b>50-209</b>	
18 cm	4 mm		+	<b>50-200</b>	<b>50-210</b>	
18 cm	5 mm		+	<b>50-201</b>	<b>50-211</b>	
18 cm	6 mm		+	<b>50-202</b>	<b>50-212</b>	
23 cm	2 mm		-	<b>50-203</b>		
23 cm	3 mm		+	<b>50-204</b>		
23 cm	4 mm		+	<b>50-205</b>		
23 cm	5 mm		+	<b>50-206</b>		

130° Yukarıya doğru kesme/Upwards cutting



Standart ağız tabanlı  
Standard footplate



Ince ağız tabanlı  
With thin footplate



Standart ağız tabanlı  
Standard footplate



Ince ağız tabanlı  
With thin footplate

Ayrılabilir/Detachable

Boy Length	En Width	Ejektör Ejector	Ayrılabilir/Detachable					
18 cm	1 mm	-		50-213		50-229	50-243	50-259
18 cm	2 mm	-		50-214		50-230	50-244	50-260
18 cm	3 mm	+		50-215		50-231	50-245	50-261
18 cm	4 mm	+		50-216		50-232	50-246	50-262
18 cm	5 mm	+		50-217		50-233	50-247	50-263
18 cm	6 mm	+		50-218		-	50-248	50-264
20 cm	1 mm	-		50-219		50-234	50-249	50-265
20 cm	2 mm	-		50-220		50-235	50-250	50-266
20 cm	3 mm	+		50-221		50-236	50-251	50-267
20 cm	4 mm	+		50-222		50-237	50-252	50-268
20 cm	5 mm	+		50-223		50-238	50-253	50-269
20 cm	6 mm	+		50-224		-	50-254	-
23 cm	2 mm	-		50-225		50-239	50-255	50-270
23 cm	3 mm	+		50-226		50-240	50-256	50-271
23 cm	4 mm	+		50-227		50-241	50-257	50-272
23 cm	5 mm	+		50-228		50-242	50-258	50-273

130° Yukarıya doğru kesme/Upwards cutting

























Standart ağız tabanlı  
Standard footplate



Ince ağız tabanlı  
With thin footplate

Standart/Standard

Boy Length	En Widht			
18 cm	1 mm		<b>50-274</b>	<b>50-294</b>
18 cm	2 mm		<b>50-275</b>	<b>50-295</b>
18 cm	3 mm		<b>50-276</b>	<b>50-296</b>
18 cm	4 mm		<b>50-277</b>	<b>50-297</b>
18 cm	5 mm		<b>50-278</b>	<b>50-298</b>
18 cm	6 mm		<b>50-279</b>	
20 cm	1 mm		<b>50-280</b>	<b>50-299</b>
20 cm	2 mm		<b>50-281</b>	<b>50-300</b>
20 cm	3 mm		<b>50-282</b>	<b>50-301</b>
20 cm	4 mm		<b>50-283</b>	<b>50-302</b>
20 cm	5 mm		<b>50-284</b>	<b>50-303</b>
20 cm	6 mm		<b>50-285</b>	<b>50-304</b>
21.5 cm	2 mm		<b>50-286</b>	<b>50-305</b>
21.5 cm	3 mm		<b>50-287</b>	<b>50-306</b>
21.5 cm	4 mm		<b>50-288</b>	<b>50-307</b>
21.5 cm	5 mm		<b>50-289</b>	<b>50-308</b>
23 cm	2 mm		<b>50-290</b>	<b>50-309</b>
23 cm	3 mm		<b>50-291</b>	<b>50-310</b>
23 cm	4 mm		<b>50-292</b>	<b>50-311</b>
23 cm	5 mm		<b>50-293</b>	<b>50-312</b>

130° Aşağıya doğru kesme/Downwards cutting



Standart ağız tabanlı  
Standard footplate

Ince ağız tabanlı  
With thin footplate

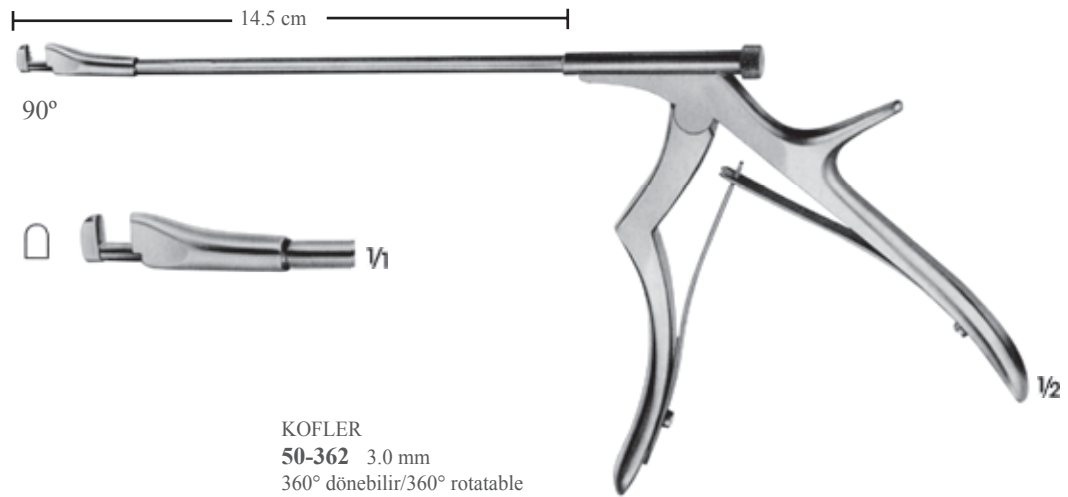
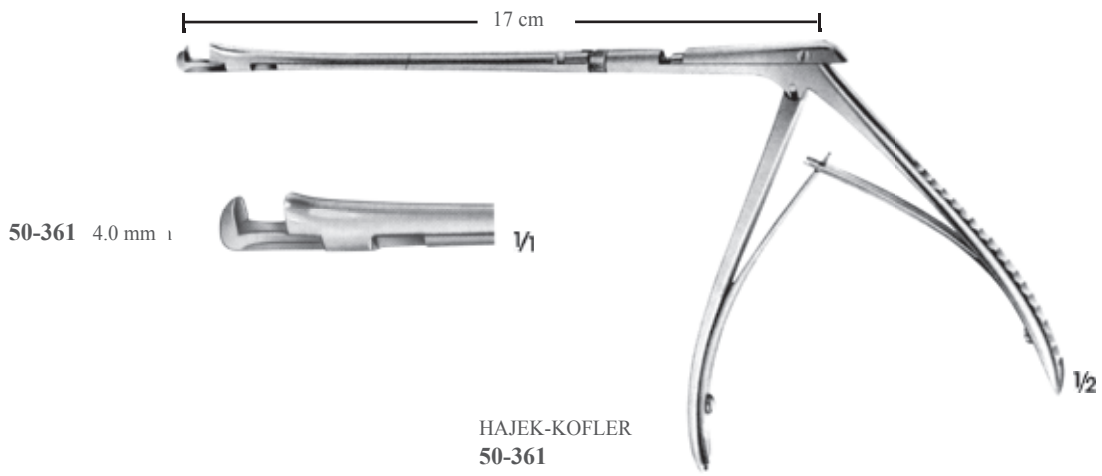
Standart ağız tabanlı  
Standard footplate

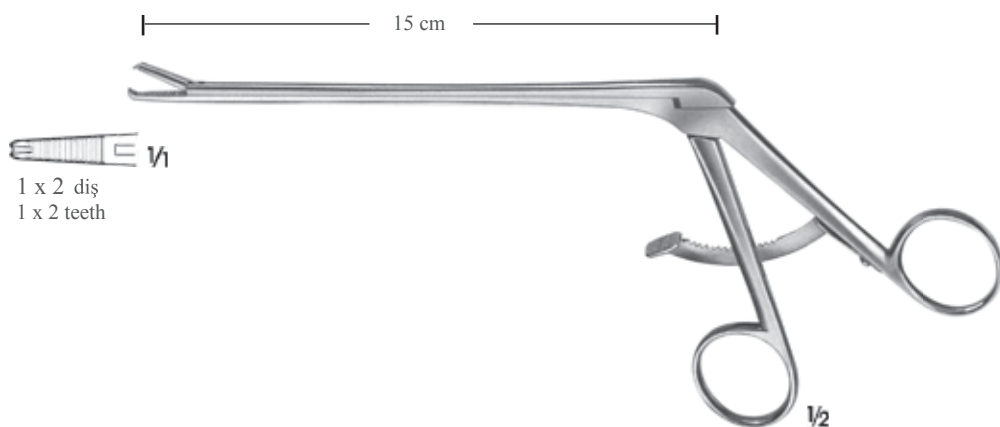
Ince ağız tabanlı  
With thin footplate

Ayrılabilir/Detachable

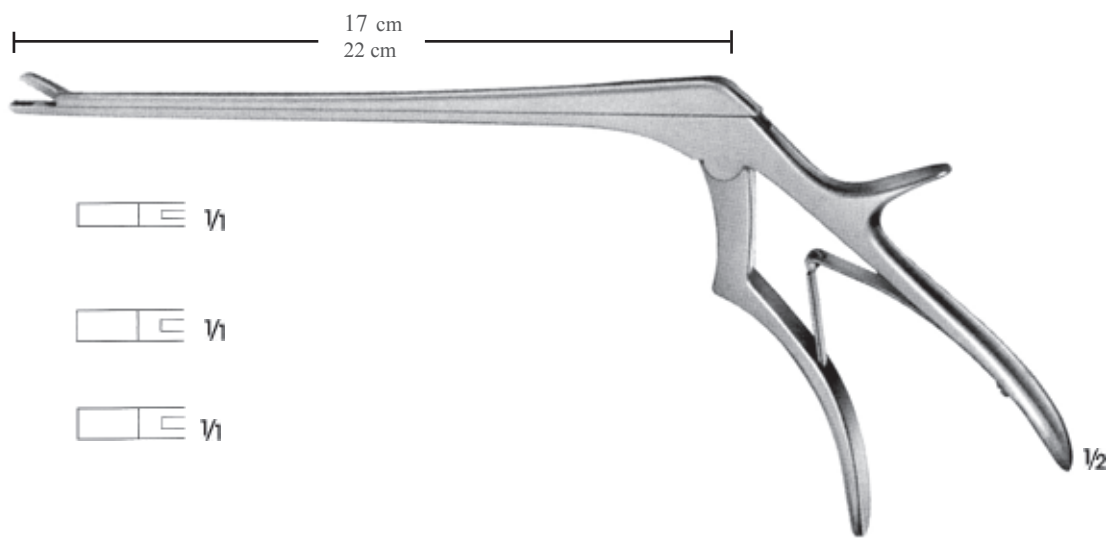
Standart/Standard

Boy Length	En Width	Ejektör Ejector				
18 cm	1 mm	□ -	50-313	50-326	50-339	50-352
18 cm	2 mm	□ -	50-314	50-327	50-340	50-353
18 cm	3 mm	□ +	50-315	50-328	50-341	50-354
18 cm	4 mm	□ +	50-316	50-329	50-342	50-355
18 cm	5 mm	□ +	50-317	50-330	50-343	50-356
21.5 cm	2 mm	□ -	50-318	50-331	50-344	
21.5 cm	3 mm	□ -	50-319	50-332	50-345	
21.5 cm	4 mm	□ +	50-320	50-333	50-346	
21.5 cm	5 mm	□ +	50-321	50-334	50-347	
23 cm	2 mm	□ -	50-322	50-335	50-348	50-357
23 cm	3 mm	□ +	50-323	50-336	50-349	50-358
23 cm	4 mm	□ +	50-324	50-337	50-350	50-359
23 cm	5 mm	□ +	50-325	50-338	50-351	50-360





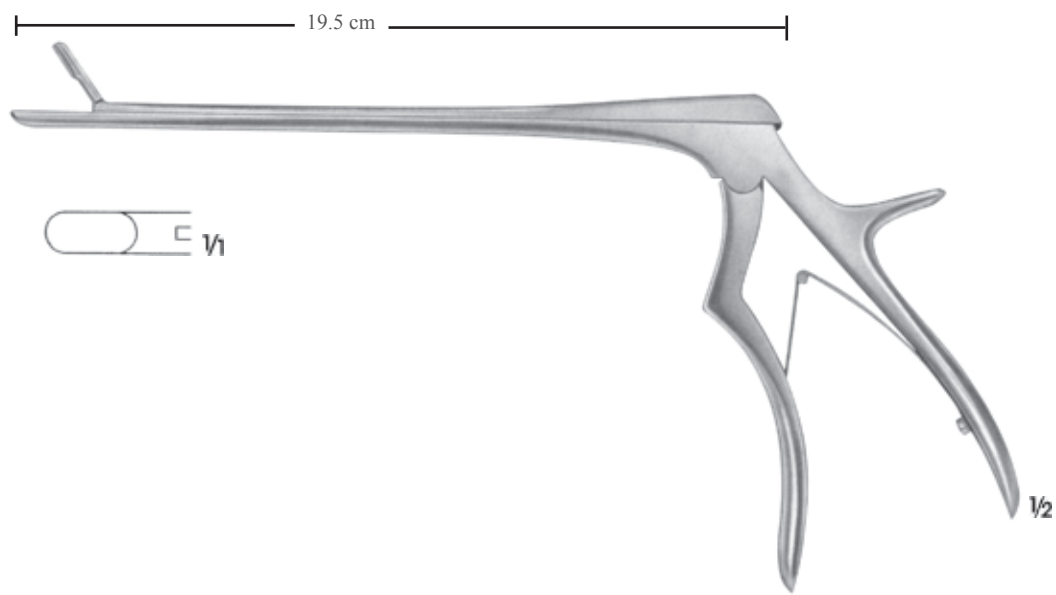
**KRAMER**  
**50-363** 15 cm  
 Bağ tutucu grasping pens, kilitli  
 With catch grasping forceps for  
 ligamentum flavum



**CASPAR**  
**50-364** 3 mm  
 18 cm

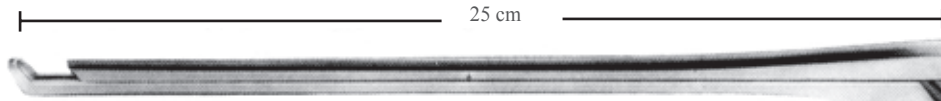
**CASPAR**  
**50-365** 4 mm  
 18 cm

**CASPAR**  
**50-366** 4 mm  
 20.5 cm

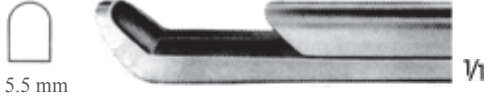


**WAGNER**  
**50-367** 5.5 mm





130° Yukarıya doğru kesme  
Upwards cutting



SYPERT  
50-368

1/2



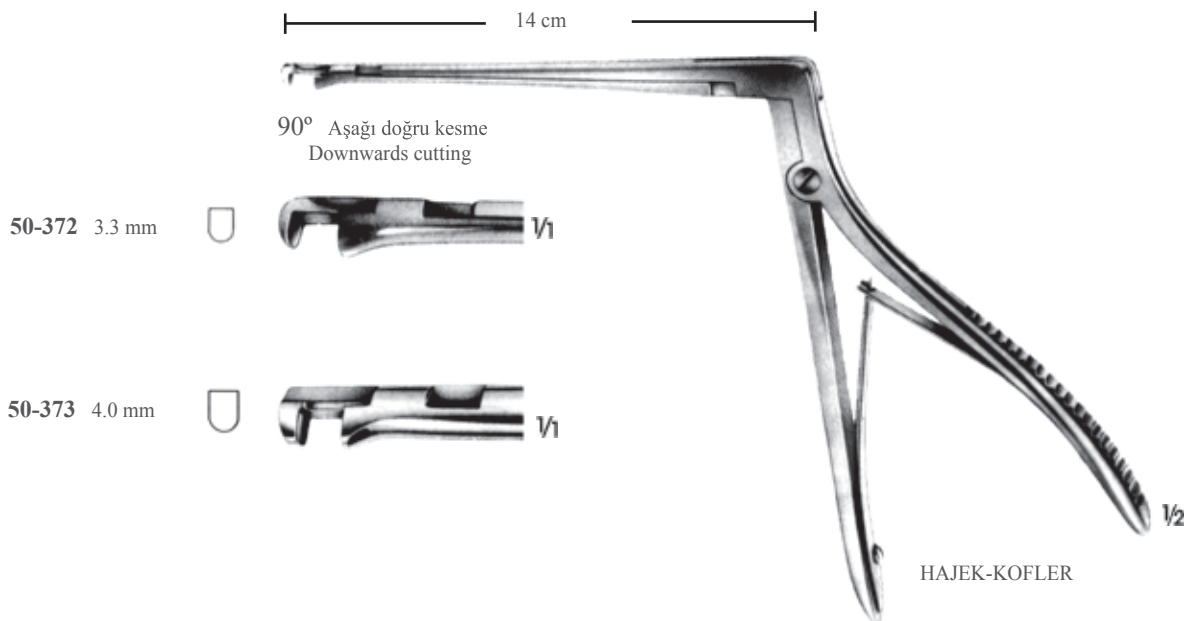
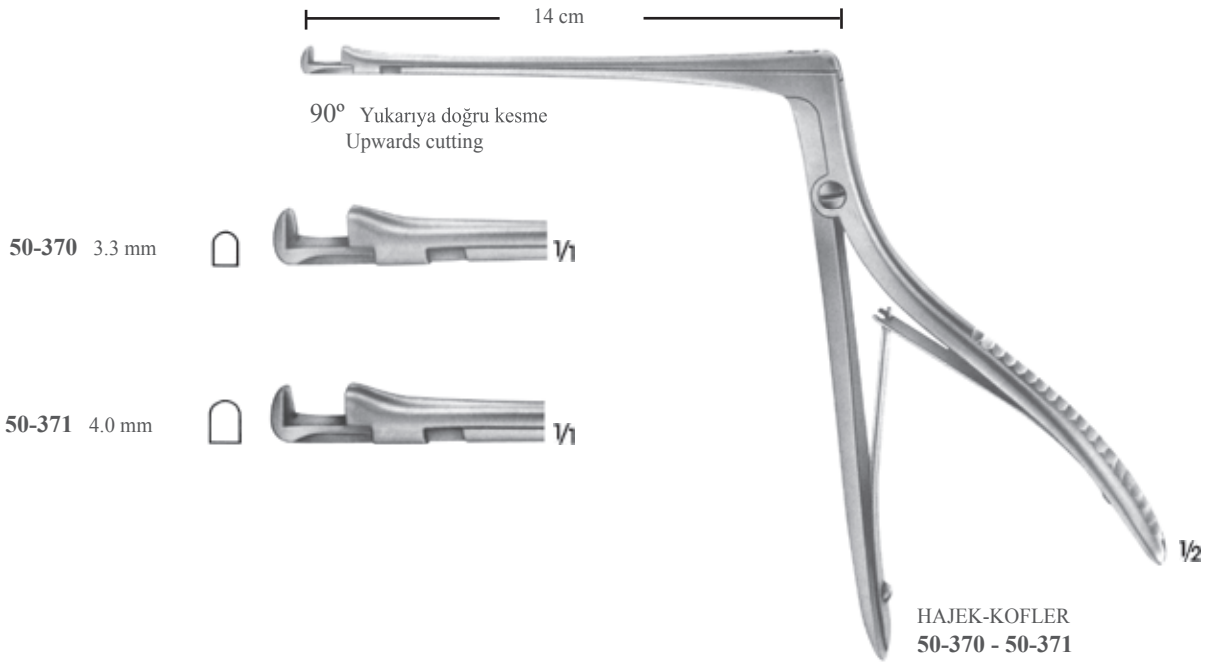
105° Yukarıya doğru kesme  
Upwards cutting



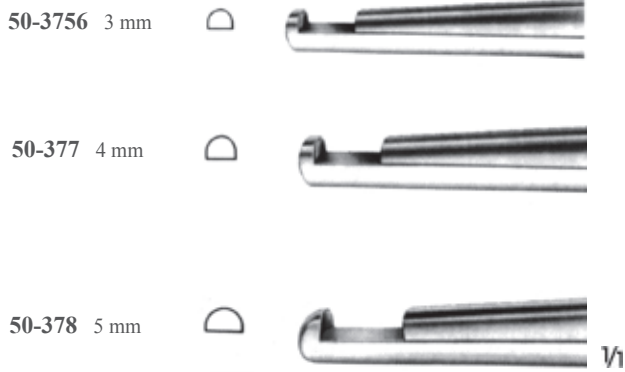
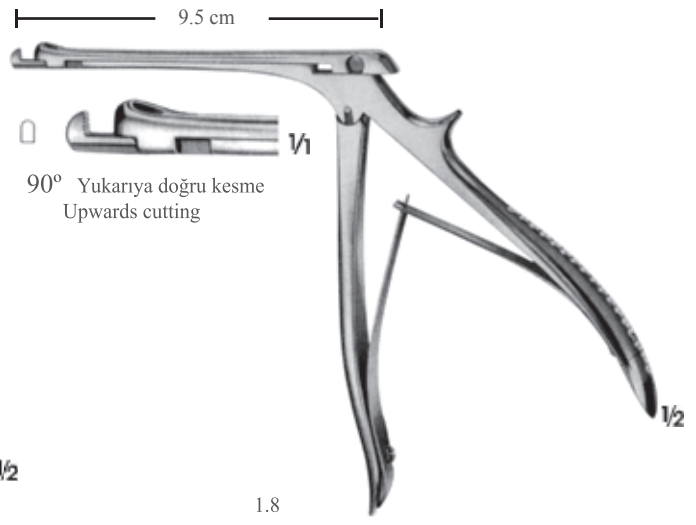
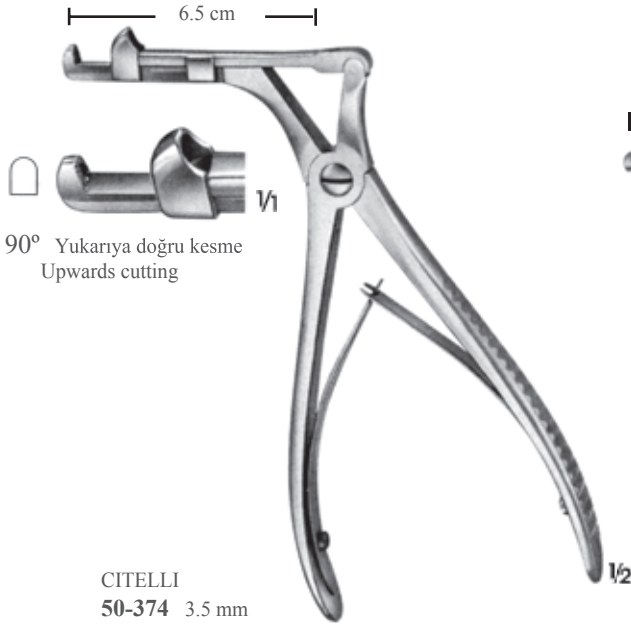
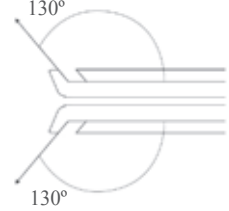
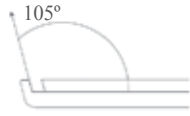
RICHTER  
50-369

1/2





Pançlar için açılı pozisyonlar  
Angled positions for punches



Silikon Kaplı Beyin Kaşığı  
Bükülebilir silikon kaplı elastik metal kaşık  
Atraumatik açma  
Tek kullanımlık  
10'luk Paket

Silikone Coated Brain Spatula  
Malleable metal spatula with elastic silicone coating  
Atraumatic retraction  
For single use  
1 package of 10 pieces



**50-379** 6 mm  
20 cm



**50-380** 7.5 mm  
20 cm



**50-381** 10 mm  
20 cm



**50-382** 12.5 mm  
20 cm



**50-383** 15 mm  
20 cm



**50-384** 7 + 8 mm  
**50-385** 10 + 11 mm  
**50-386** 13 + 14 mm  
**50-387** 16 + 17 mm  
**50-388** 19 + 20 mm  
**50-389** 22 + 25 mm  
Bükülebilir/Malleable  
20 cm



**50-390** 9 mm  
**50-391** 12 mm  
20 cm  
**50-392** 12 mm  
25 cm  
**50-393** 13 X 19 mm  
**50-394** 15 X 19 mm  
**50-395** 19 X 25 mm  
20 cm  
Bükülebilir/Malleable



HEIFETZ  
**50-396** 8 mm  
**50-397** 11 mm  
**50-398** 14 mm  
**50-399** 17 mm  
**50-400** 20 mm  
Bükülebilir/Malleable  
20 cm



HEIFETZ  
**50-401** 8 mm  
**50-402** 11 mm  
**50-403** 14 mm  
**50-404** 17 mm  
Bükülebilir/Malleable  
15.5 cm



**50-405** 12 mm  
**50-406** 17 mm 20  
cm  
**50-407** 25 mm 25  
cm  
Bükülebilir/Malleable

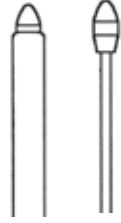


**50-408** 7 + 9 mm  
**50-409** 11 + 13 mm  
**50-410** 15 + 18 mm  
**50-411** 18 + 22 mm  
Bükülebilir/Malleable  
18 cm

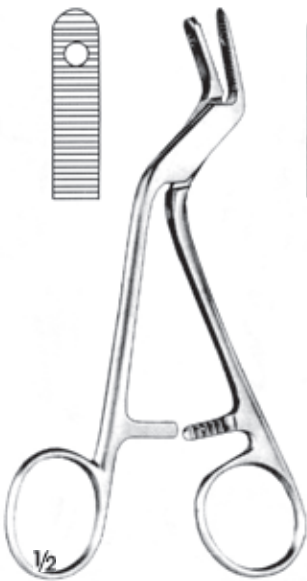


OLIVECRONA  
**50-412** 7 + 9 mm  
**50-413** 11 + 13 mm  
**50-414** 15 + 18 mm  
**50-415** 18 + 22 mm  
Esneyebilir/Flexible  
18 cm





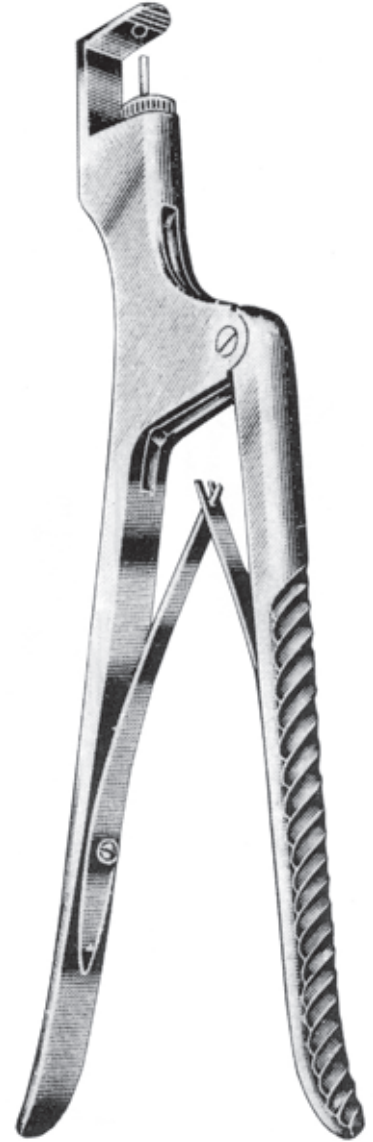
50-416 Ø 4 mm  
43.5 cm  
50-417 Ø 4 mm  
60 cm



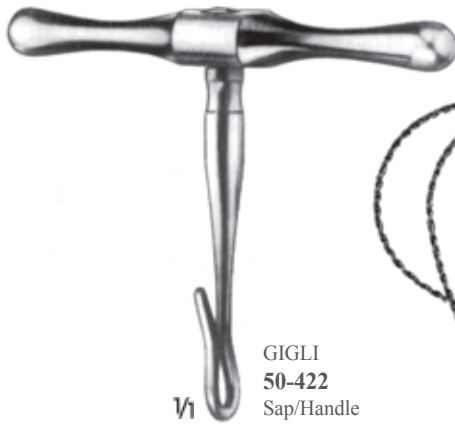
ADSON  
50-418  
15 cm



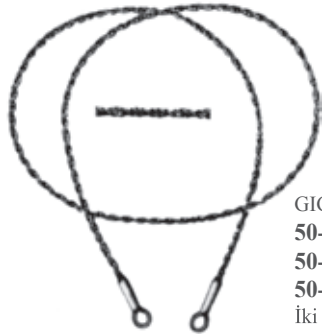
50-419  
Koruma pensi  
Protection forceps  
20.5 cm



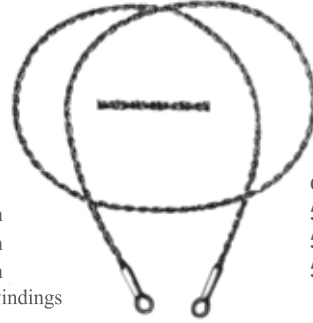
SWEET  
50-420 20 cm  
50-421 23 cm



GIGLI  
50-422  
Sap/Handle



GIGLI  
50-423 30 cm  
50-424 40 cm  
50-425 50 cm  
İki sargılı/Two windings



GIGLI  
50-426 30 cm  
50-427 40 cm  
50-428 50 cm  
Üç sargılı/Three winding



DE MARTEL 50-429  
35 cm  
Kondüktör için gigli testere teli, esnek  
Gigli saw for the flexible conductor wire



DAHLGREN

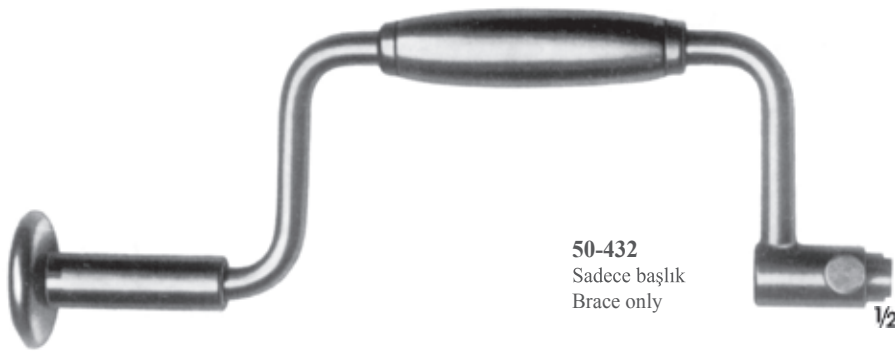


1/2  
DAHLGREN  
50-430  
2 huk ile birlikte  
With 2 extra hooks  
21 cm

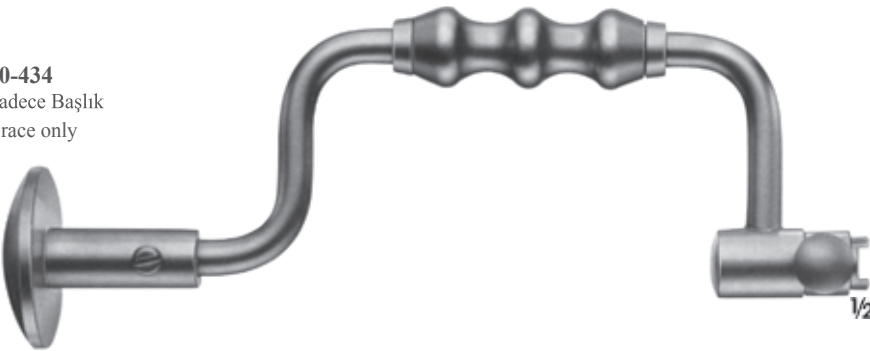


1/2  
DE VILBISS  
50-431  
1 huk dahil/with 1 hook  
20 cm





50-434  
Sadece Başlık  
Brace only



HUDSON  
50-436  
El matkabı  
Hand drill

HUDSON DOWNS



CUSHING  
50-438  
Ø 10 mm



CUSHING  
50-439  
Ø 15 mm



CUSHING  
50-440  
Ø 14 mm



McKENZIE  
50-441  
Ø 13 mm



HUDSON  
50-442  
Ø 14 mm



HUDSON  
50-443  
Ø 16 mm



ADSON  
50-444  
Ø 15 mm



HUDSON  
50-445  
Ø 22 mm



HUDSON  
50-446  
Ø 9 mm



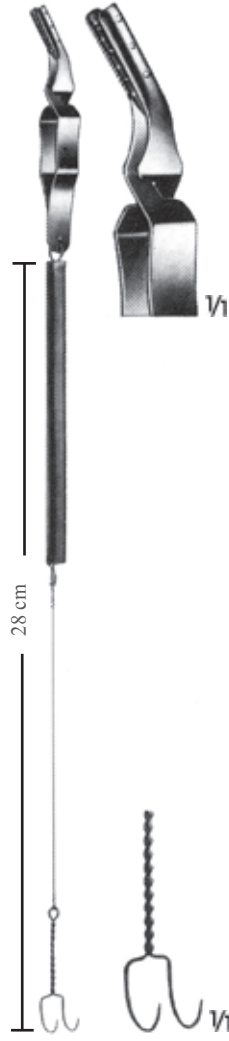
50-447  
Ø 2 mm



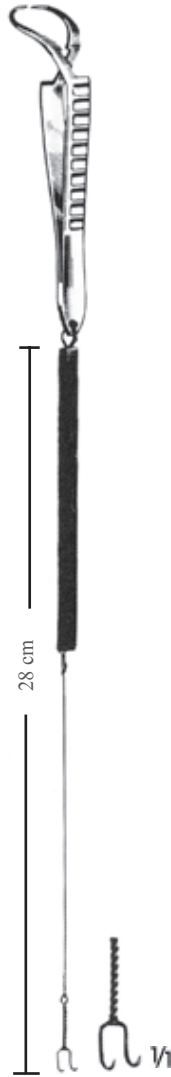
Galea tespitinde kullanılan Buldog klempı yaylı kanca, örtü bezine bağlanabilir.  
Spring hook for galea fixation with Bulldog clamp, to be fastened to covering drape.



**YASARGIL**  
**50-449**  
26 cm

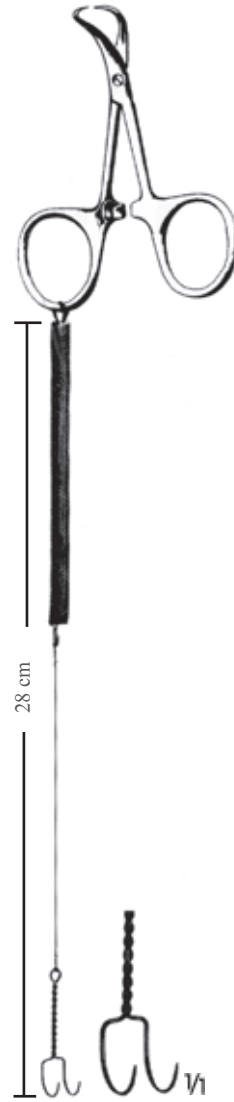


**YASARGIL**  
**50-450**  
28 cm

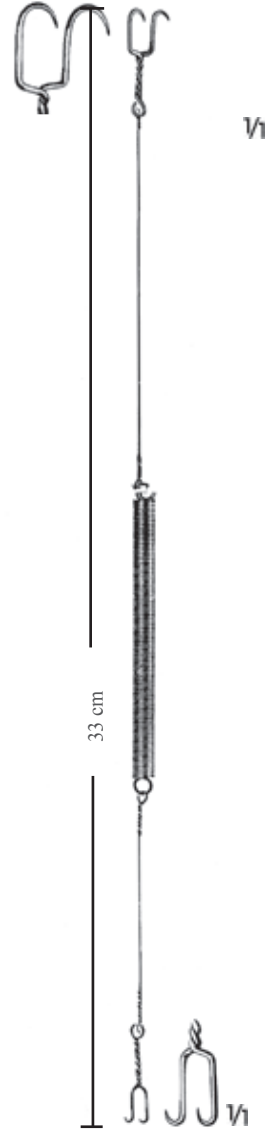


**50-451**  
28 cm

26 cm



**50-452**  
28 cm



**50-453**  
33 cm

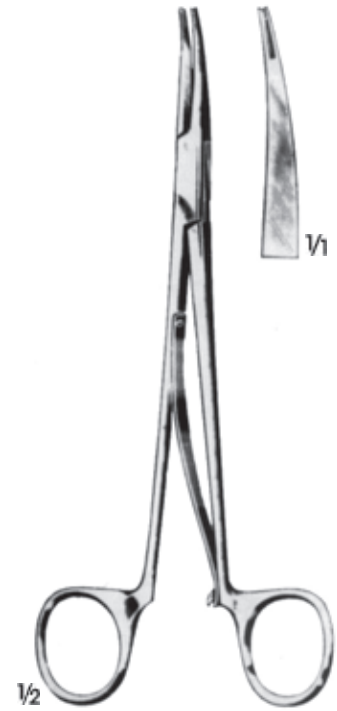




1/2  
RANEY  
50-454  
16 cm



1/2  
McKENZIE  
50-455  
15 cm



1/2  
McKENZIE  
50-456  
19 cm



50-457 25°  
15 cm  
50-458 25°  
20 cm  
50-459 25°  
28 cm



50-460 65°  
20 cm  
50-461 65°  
28 cm



50-462 25°  
15 cm  
50-463 25°  
20 cm  
50-464 25°  
28 cm



50-465 65°  
20 cm  
50-466 65°  
28 cm



50-467 25°  
20 cm  
50-468 25°  
28 cm





1.0 mm  
Eğri/Curved



CASPAR  
50-469  
20 cm



50-470 3 mm  
Künt/Blunt  
18.5 cm



50-471 3 mm  
Künt/Blunt  
21.5 cm



YASARGIL 50-472  
3 mm Çocuklar için,  
esnek Flexible for  
children 19.5 cm



YASARGIL  
50-473 7 mm  
Flexible for adults  
19.5 cm





V1

JACOBSON  
Sonda, küresel uçlu  
Probe with ball tip  
18.5 cm



50-474



50-475

V1



V2

ASSMUS  
50-476 Ø 3 mm  
Sonda, küresel uçlu  
Probe with ball tip  
39.5 cm



V1

V1



V1

CASPAR  
50-477  
Ligatür ayarlayıcısı  
Ligature adjuster  
23 cm



V1









**YASARGIL 50-491**  
Mikro raspa, açılı  
Micro raspatory,  
angled  
18.5 cm



**YASARGIL 50-492**  
Mikro disektör, açılı  
Micro dissector,  
angled  
18.5 cm



**YASARGIL 50-493**  
Mikro disektör, açılı  
Micro dissector,  
angled  
18.5 cm



**YASARGIL 50-494**  
Mikro raspa, hafif  
kavisli  
Micro raspatory,  
slightly curved  
18.5 cm



**YASARGIL 50-495**  
Mikro raspa, eğri  
Micro raspatory,  
curved  
18.5 cm



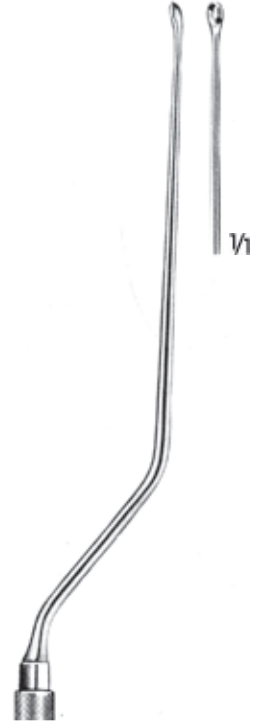
**YASARGIL 50-496**  
Mikro raspa, aşağı eğimli  
Micro raspatory, down-  
wards curved  
18.5 cm



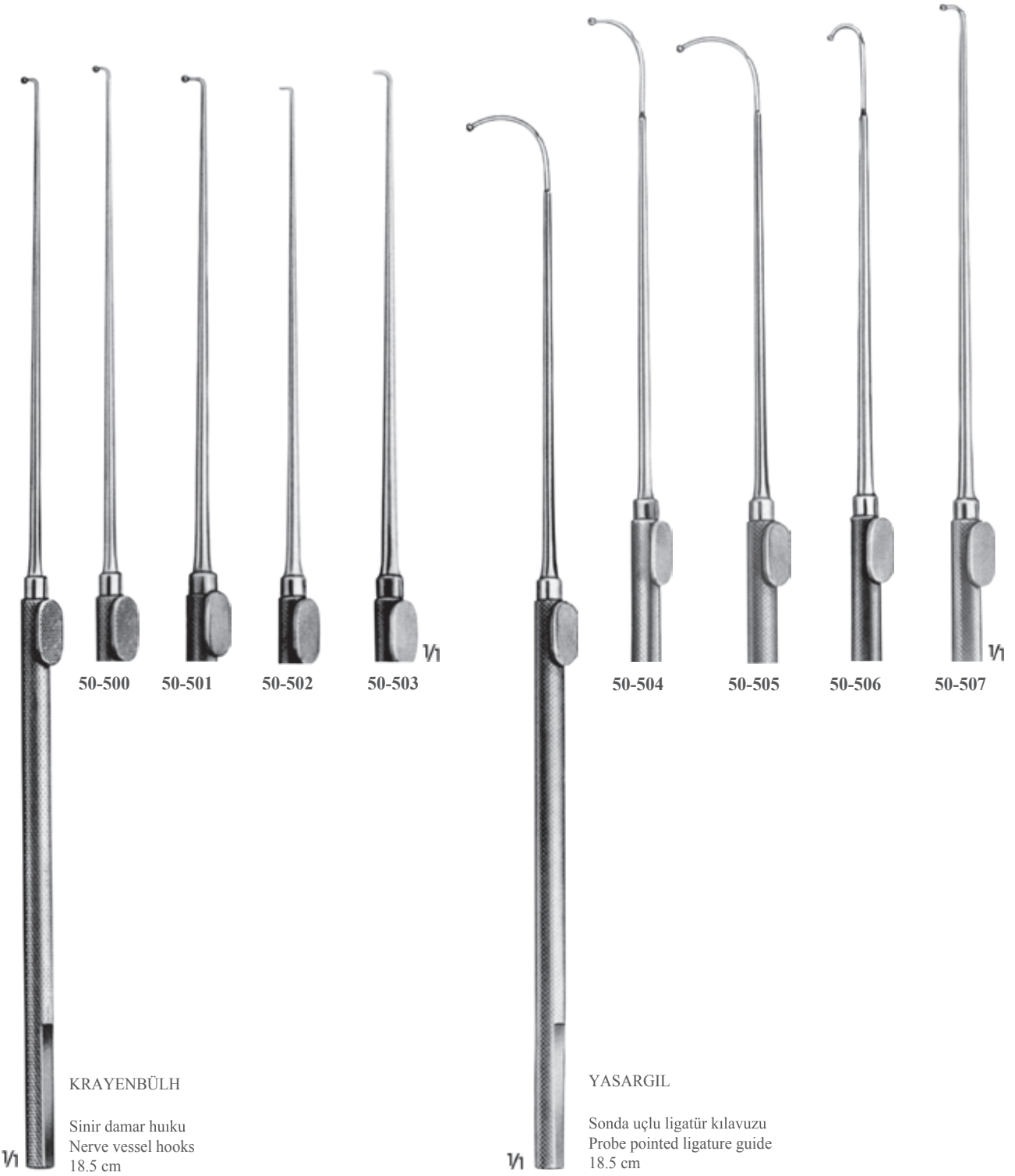
**YASARGIL 50-497**  
Mikro raspa, aşağı eğimli  
Micro raspatory, downwards  
curved  
18.5 cm



**YASARGIL 50-498**  
Mikro raspa, yukarı eğimli  
Micro raspatory, upwards  
curved  
18.5 cm



**YASARGIL 50-499**  
Mikro kaşık küret  
Micro scoop  
18.5 cm









**50-524**  
Doku piki  
Tissue pick  
18.5 cm



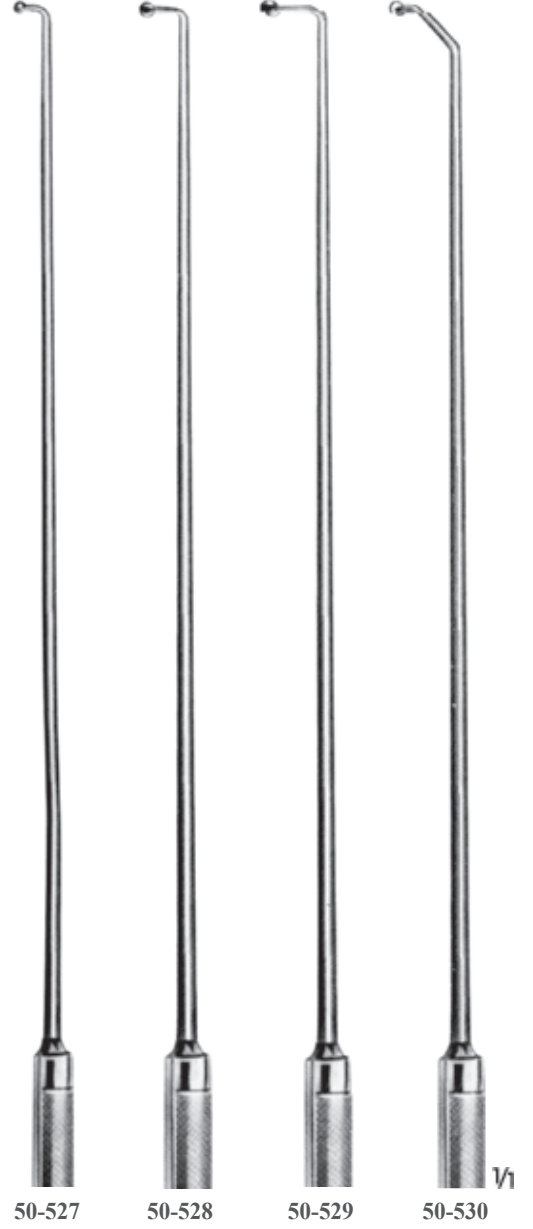
**50-525**  
Sivri huk 90° açılı  
Sharp hook, 90°  
angled  
18.5 cm



**FISCH**  
**50-526**  
Sivri huk 90° açılı  
Sharp hook, 90°  
angled  
18.5 cm



**CASPAR**  
**50-527 - 50-530**  
Keşif hukları sonda uçlu  
Exploration hooks, probe-pointed  
24.5 cm





Mikro huk/Sivri  
Micro hook/Sharp  
23 cm



**50-531**  
Mikro huk, күnt  
Micro hook, blunt  
23 cm



**50-532**  
Mikro disektör, düz  
Micro dissector,  
straight  
23 cm



**50-533**  
Mikro disektör, düz  
Micro dissector,  
straight  
23 cm



**50-534**  
Mikro kepeç düz,  
keskin  
Micro scoop,  
straight, sharp  
23 cm



**50-535**  
Mikro kepeç açılı,  
keskin  
Micro scoop,  
angled, sharp  
23 cm



**50-536**  
Mikro raspa,  
yuvarlak blade  
Micro raspatory,  
round blade  
23 cm





V1  
18.5 cm



KOOS  
**50-537**  
Yukarı eğimli  
Curved upwards



KOOS  
**50-538**  
Aşağı eğimli  
Curved downwards



KOOS  
**50-539**  
Yukarı eğimli  
Curved upwards



KOOS  
**50-540**  
Aşağı eğimli  
Curved downwards



KOOS  
**50-541**  
Aşağı eğimli  
Curved downwards



KOOS  
**50-542**  
Yukarı eğimli  
Curved upwards



YAŞARGIL  
**50-543**  
Aşağı eğimli  
Curved downwards



YAŞARGIL  
**50-544**  
Yukarı eğimli  
Curved upwards







LANDOLT  
**50-551** Sağ, künt  
Blunt, right  
26 cm  
**50-552** Sol,  
künt Blunt, left  
Bükülebilir/Malleable  
26 cm



LANDOLT  
**50-553**  
Küret, bükülebilir  
Curette, malleable  
26 cm



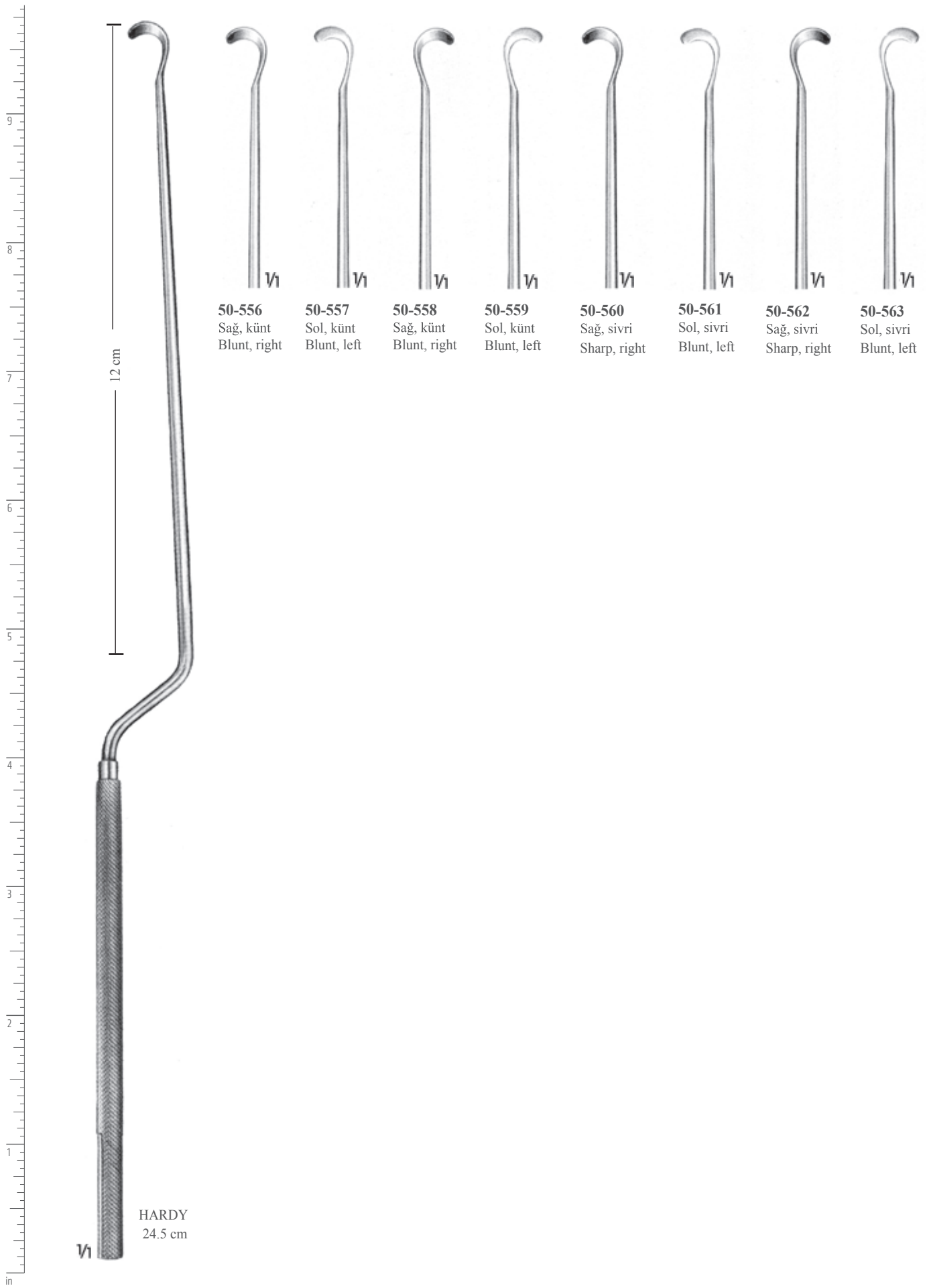
LANDOLT  
**50-554**  
Kaşık, bükülebilir  
Spoon, malleable  
26 cm

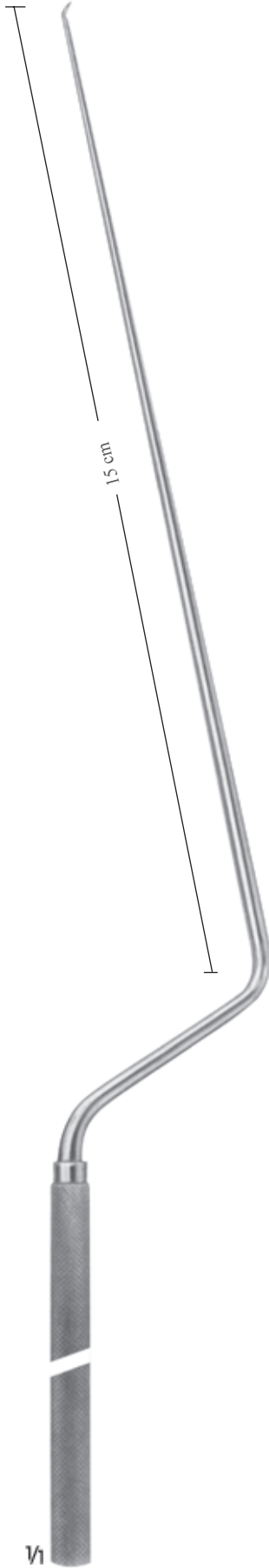


LANDOLT  
**50-555**  
Künt huk/Blunt hook  
Bükülebilir/Malleable  
26 cm

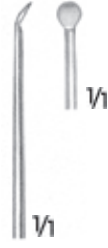
LANDOLT  
Malleable  
26 cm







LANDOLT-REULEN  
**50-564** Ø 2.2 mm  
Raspa, esnemez  
Raspatories, rigid  
26 cm



LANDOLT-REULEN  
**50-565** Ø 3.2 mm  
Raspa, esnemez  
Raspatories, rigid  
26 cm



LANDOLT-REULEN  
**50-566** Ø 2.5 mm  
Küret, esnemez  
Curette, rigid  
26 cm



LANDOLT-REULEN  
**50-567** Ø 1.7 mm  
Künt huk/Blunt hook  
26 cm



FAHLBUSCH  
**50-568** Ø 2.0 mm  
Kaşık, bükülebilir  
Spoon, malleable  
26 cm



FAHLBUSCH  
**50-569** Ø 2.5 mm  
Küret, bükülebilir  
Curette, malleable  
26 cm



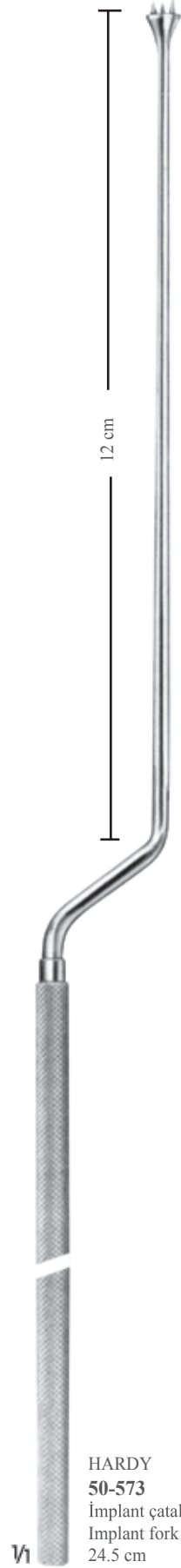




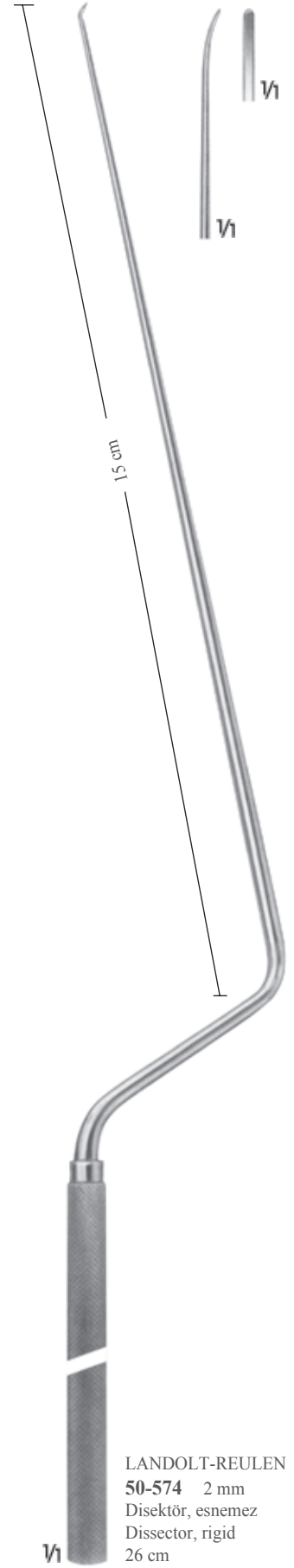
NICOLA  
**50-570**  
Raspa/Raspatory  
21.5 cm



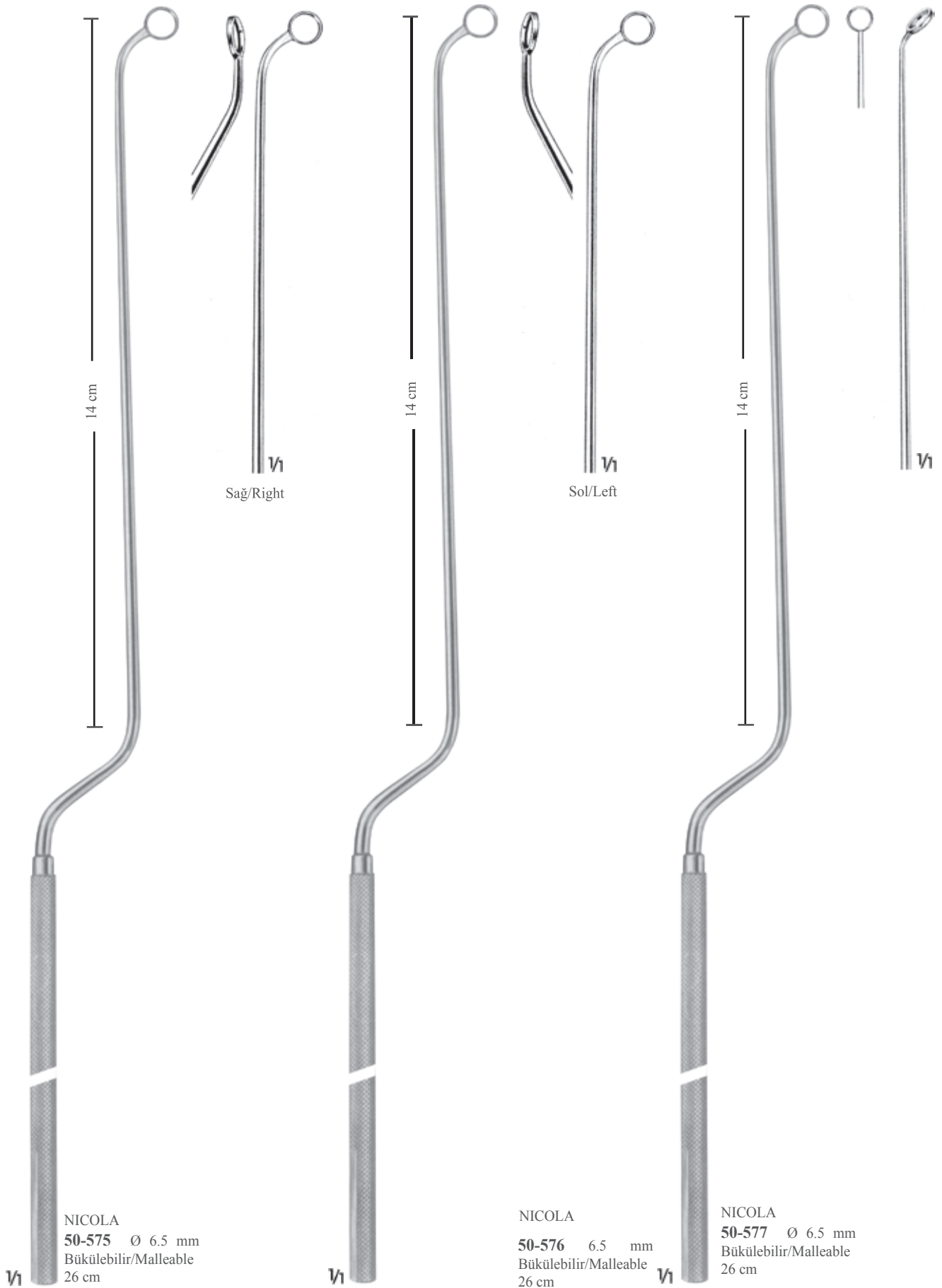
HARDY-FAHLBUSCH  
**50-571 - 50-572**  
Disektörler/Dissectors  
Keskin/ Sharp  
24.5 cm



HARDY  
**50-573**  
İmplant çatalı  
Implant fork  
24.5 cm



LANDOLT-REULEN  
**50-574** 2 mm  
Disektör, esnemez  
Dissector, rigid  
26 cm



NICOLA  
**50-575** Ø 6.5 mm  
Bükülebilir/Malleable  
26 cm

NICOLA  
**50-576** 6.5 mm  
Bükülebilir/Malleable  
26 cm

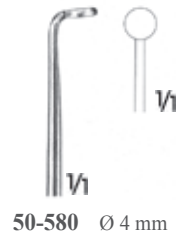
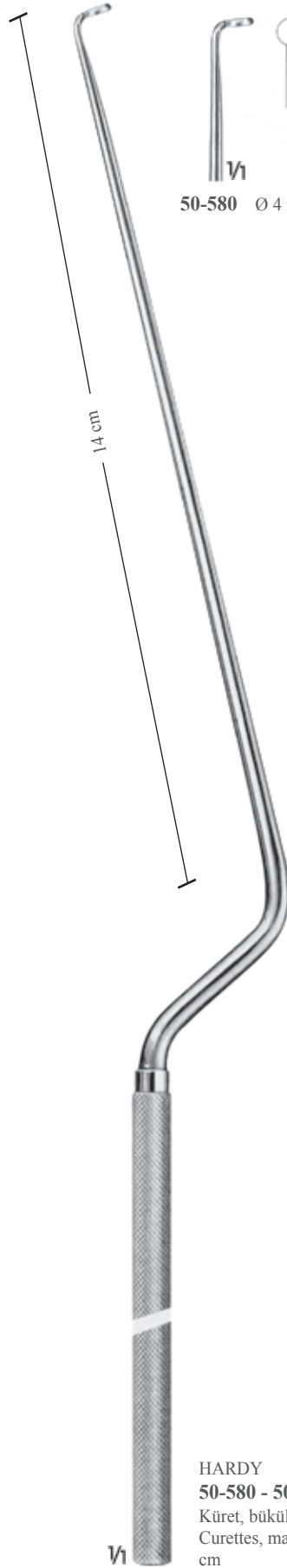
NICOLA  
**50-577** Ø 6.5 mm  
Bükülebilir/Malleable  
26 cm



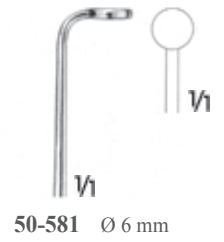
RAY  
**50-578** Ø 4 mm  
Küret 45° dikey  
Curette vertical 45°  
18 cm



RAY  
**50-579** Ø 4 mm  
Küret 45° Yatay  
Curette Horizontal 45°  
18 cm



**50-580** Ø 4 mm



**50-581** Ø 6 mm



Bleyd No.3  
Blade No.3



**50-582**  
Bistüri sapı  
Scalpel handle  
21 cm



CASPAR  
**50-583**  
Mikro bıçak,künt  
Micro knife, blunt tip  
20 cm



CASPAR  
**50-584**  
Mikro bıçak,künt  
Micro knife, blunt tip  
20 cm





**50-585**  
Ayna sapı  
Mirror handle  
10.5 cm

**50-586**  
Laringel ayna  
Laryngeal mirror  
12 cm



**50-587**  
Altıgen saplı Laringel  
aynar  
Laryngeal mirror with  
Hexagonal handle  
18 cm



YASARGIL  
**50-588** Ø 6 mm  
Hareketli mikro ayna  
Movable micro mirror  
24 cm

**50-589**  
Ayna/Mirror  
26 cm



MAYFIELD  
**50-590**  
Kafa klempi/Skull clamp



GARDNER  
**50-591** 10 mm  
Yetişkinler için  
Adult size  
25 mm



MAYFIELD  
**50-592**  
Yetişkinler için  
Adult size



MAYFIELD  
**50-593**  
Çocuklar için  
Child size

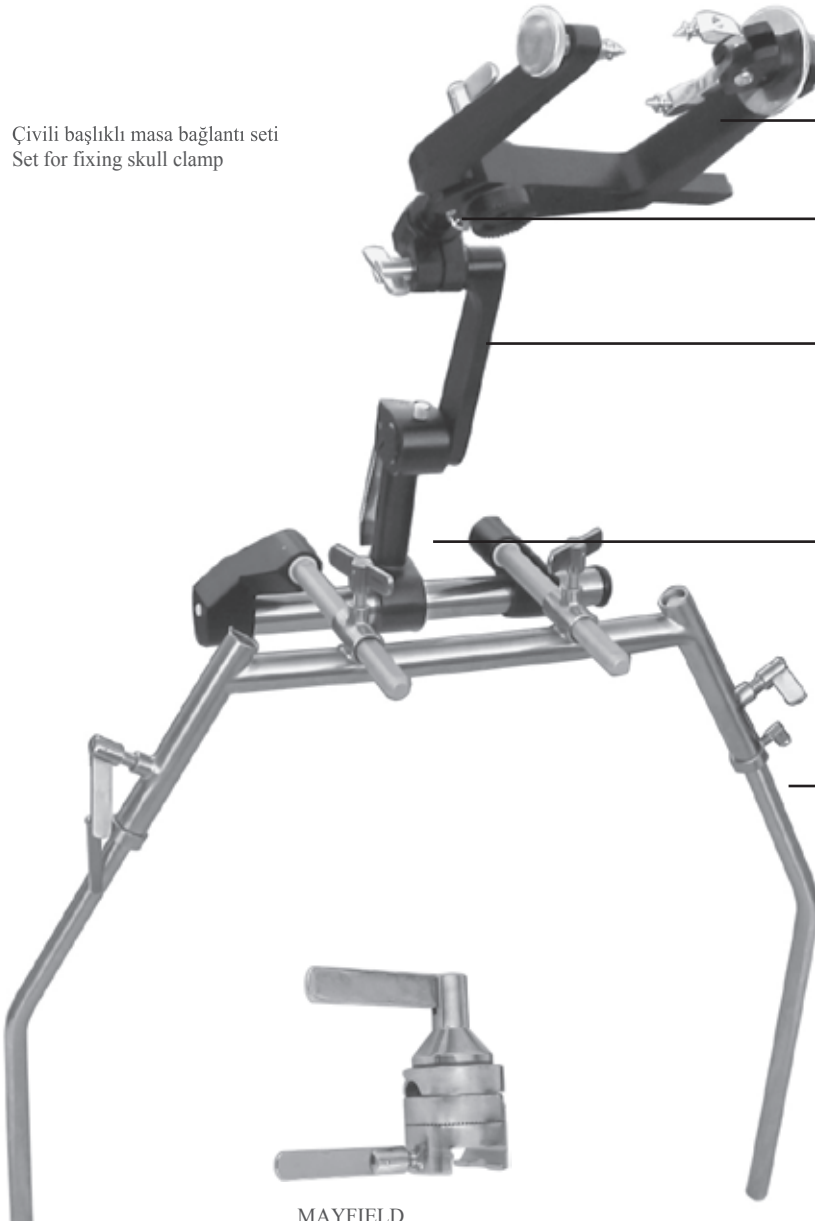


GARDNER  
**50-594** 6 mm  
Çocuklar için  
Child size  
38 mm



MT.SINAI  
**50-595** 10 mm  
Çocuklar için  
Child size  
38 mm

Çivili başlıklı masa bağlantı seti  
Set for fixing skull clamp



MAYFIELD  
**50-602** Komple/Complete

MAYFIELD  
**50-596**  
Kafa klempi/Skull clamp

MAYFIELD  
**50-597**  
Masa bağlantı aparatı  
Table fixation attachment

MAYFIELD  
**50-598**  
Masa bağlantı aparatı  
Table fixation attachment

MAYFIELD  
**50-599**  
Masa bağlantı aparatı  
Table fixation attachment

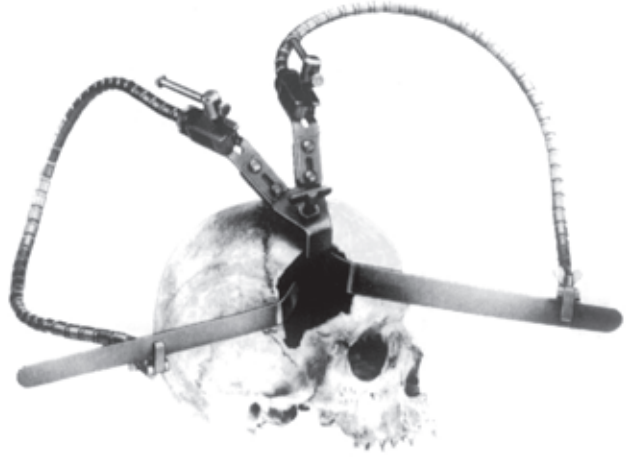
MAYFIELD  
**50-600**  
Masa bağlantı aparatı  
Table fixation attachment

MAYFIELD  
**50-601**  
Masa bağlantı aparatı  
Table fixation attachment





**YASARGIL**  
**50-603**  
Tek kollu komple otomatik beyin ekartörü  
Self-retaining brain retractor, with 1 flexible  
arm, complete, consisting of:



**YASARGIL**  
**50-604**  
İki kollu komple otomatik beyin ekartörü  
Self-retaining brain retractor, with 1 flexible  
arm, complete, consisting of:



**50-605**  
Tespit elemanı  
Fixation base



**YASARGIL**  
**50-608**  
Yalnız esnek kol  
Flexible arm only



**50-606**  
Tespit elemanı  
Fixation base



**50-607**  
Tespit elemanı  
Fixation base

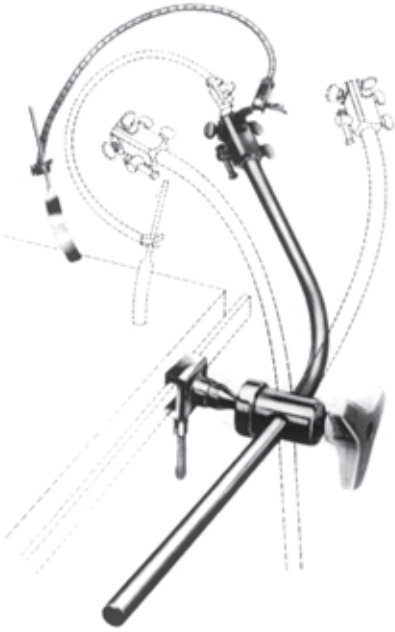


**50-609**  
Kaşık tutucu/Support only

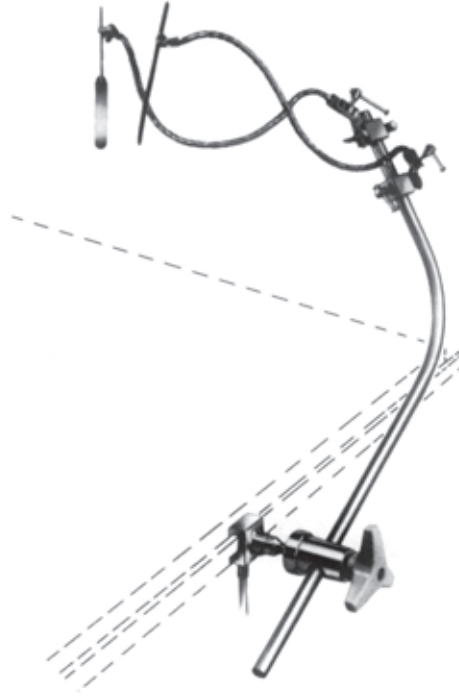


**50-610**  
Kaşık tutucu/Support only





50-611



50-612



50-613  
Bağlantı başlığı  
Coupling head

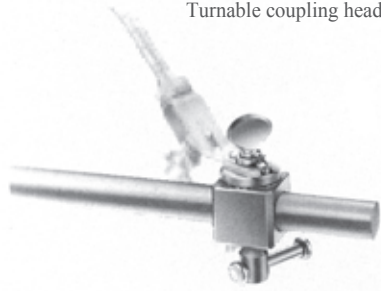


50-614  
Masa bağlantı mafsalı  
Joint for table fixation  
maximum 9 x 32 mm

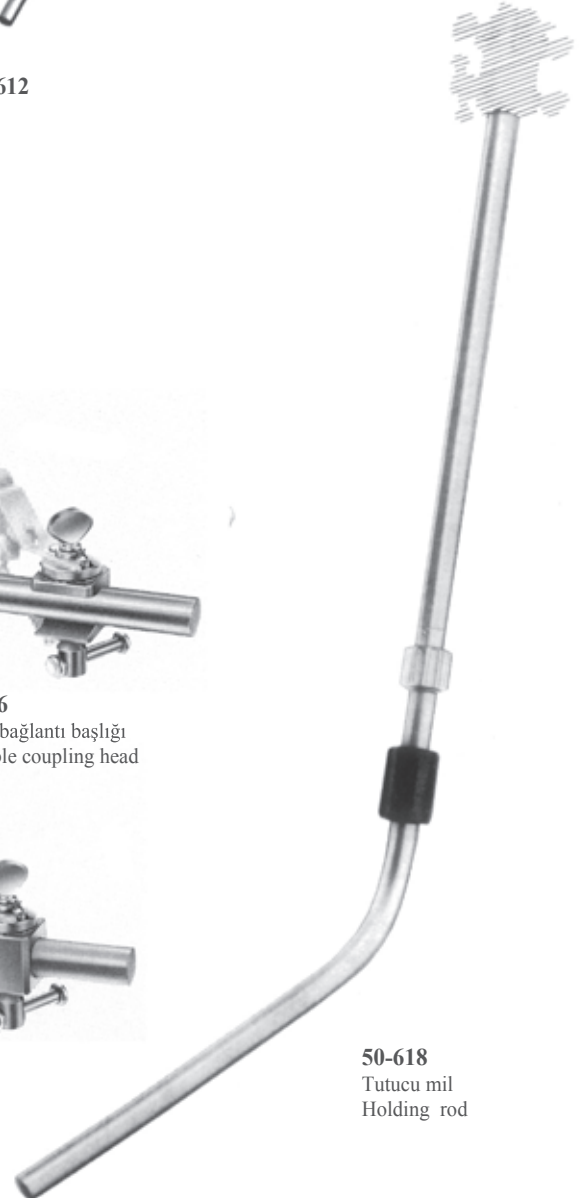
50-615  
Masa bağlantı mafsalı  
Joint for table fixation  
10 x 25 mm



50-616  
Döner bağlantı başlığı  
Turnable coupling head



50-617  
Döner bağlantı başlığı  
Turnable coupling head

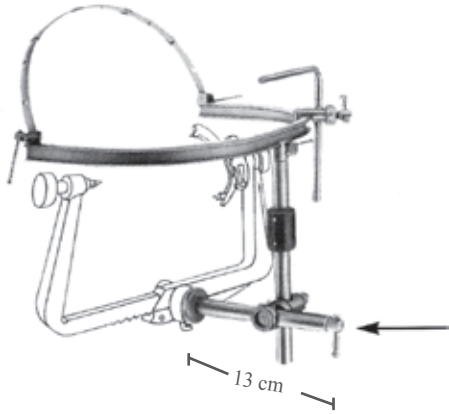


50-618  
Tutucu mil  
Holding rod





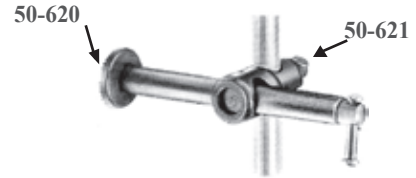
50-619 Masa bağlantı elemanı/Table Fixation attachment



50-622 Komple/Complete

50-623 Masa bağlantı elemanı/Table Fixation attachment(1 adet)

50-624 Masa bağlantı elemanı/Table Fixation attachment (1 pcs)



50-625 Masa bağlantı elemanı/Table Fixation attachment

50-626 Tutucu mil/Holding rod

50-627 Masa bağlantı mafsalı/Joint for table fixation  
9 x 32 mm

50-628 Masa bağlantı mafsalı/Joint for table fixation  
10 x 25 mm



50-629  
Pens tutucu  
Holder for forceps

GILSBACH  
50-630  
El dayama barı  
Handrest bar





GILSBACH

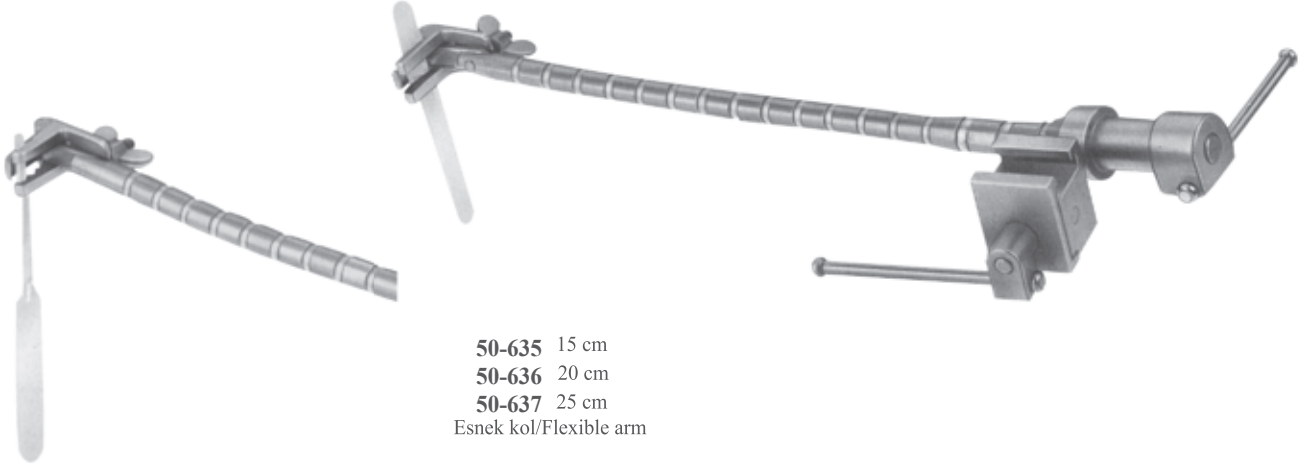
**50-631** (Komple/Complete)

Temel ünite/Basic unit

**50-632** Tutucu mil/Holding rod

**50-633** Esnek kollar için yarım daire bar/Semi-circular basic bar, for flexible arms

**50-634** Galea hukları için çerçeve/Frame for Galea hook



**50-635** 15 cm  
**50-636** 20 cm  
**50-637** 25 cm  
Esnek kol/Flexible arm



**50-638**  
Esnek kol/Flexible arm



**50-639**  
Kaşık tutucu  
Support only



**50-640**  
Kaşık tutucu  
Support only



**50-641**  
Zincirli huk



**50-642**  
Yaylı huk



YASARGIL  
50-643 Mini/Mini  
50-644 Standart/Standard  
17,5 cm



YASARGIL  
50-645 Mini/Mini  
50-646 Standart/Standard  
17,5 cm

Mini/Mini Standart/Standard

50-647 50-650



Düz/Straight

50-648 50-651



15° Açılı/15° Angled

50-649 50-652



30° Açılı/30° Angled



YASARGIL  
50-647 - 50-650  
50-648 - 50-651  
50-649 - 50-652  
21.5 cm

50-653 50-656



Düz/Straight

50-654 50-657

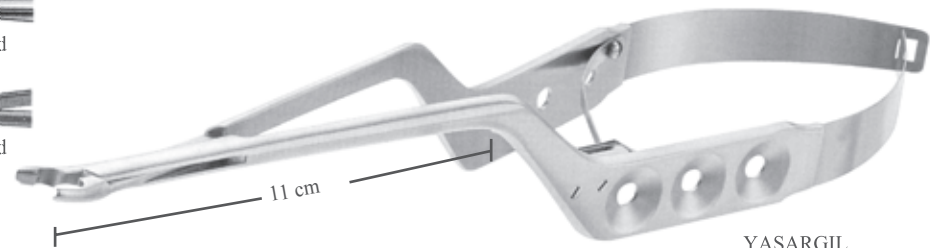


15° Açılı/15° Angled

50-655 50-658



30° Açılı/30° Angled



YASARGIL  
50-653 - 50-656  
50-654 - 50-657  
50-655 - 50-658  
23.5 cm



50-659  
Hizalama anahtarı  
Alignment key



50-660 Mini/Mini  
50-661 Standart/Standard  
21.5 cm



CUSHING-LANDOLT  
**50-662** 70 x 15 mm  
**50-663** 90 x 15 mm  
**50-664** 110 x 15 mm  
Transsfenoidal, hipofizektomi spekulum  
Specula for transsfenoidal hypophysectomy



JANSEN-MIDDLETON  
**50-665**  
20 cm



PAPAVERO  
**50-666** 4 mm  
Bayonet çızıl  
Bayonet chisel, 4 mm  
22 cm

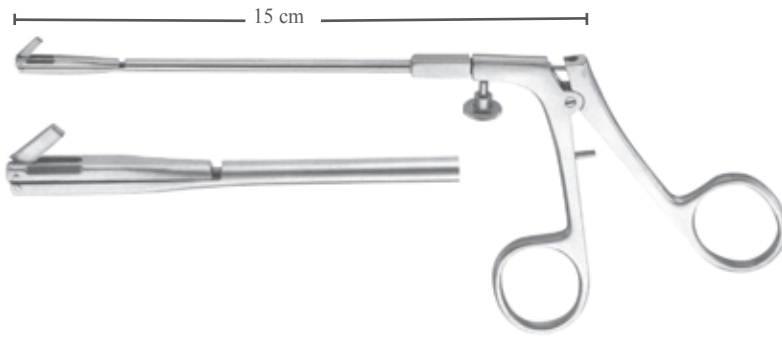


LANDOLT  
**50-667**  
Spekulum için ayırıcı  
Spreader for specula  
L 295.00-L 295.02  
21 cm



COTTLE  
**50-668** 240 gr  
Çekiç, bir tarafı düz  
bir tarafı dış bükey  
Mallet, 1 side flat, 1  
side convex  
18.5 cm





**50-669**  
Antrum panç  
Antrum punch



**50-677**  
Anahtar/Key  
15 cm

PAPAVERO-CASPAR  
**50-670** 80 x 11 mm  
**50-671** 90 x 13 mm  
**50-672** 100 x 15 mm



Ince profilli, hafif transsfenoidal spekulum  
Slim profile and lightweighted specula for  
transsfenoidal

HardCoated



**50-673**  
90 x 13 mm  
Transsfenoidal spekulum  
Transsfenoidal specula



**50-674**  
PAPAVERO-HARTMANN

$\frac{1}{2}$   
34 x 9 mm  
**50-674**



$\frac{1}{2}$   
COTTLE  
13.5 cm



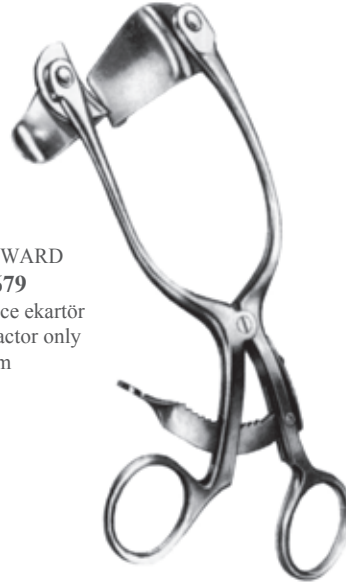
$\frac{1}{2}$   
**50-675** 76 x 7 mm



$\frac{1}{2}$   
**50-676** 90 x 7 mm



CLOWARD  
**50-678**  
Sadece ekartör  
Retractor only  
25 cm



CLOWARD  
**50-679**  
Sadece ekartör  
Retractor only  
15 cm

CLOWARD



40 mm

1/2

16 mm

**50-680**



45 mm

1/2

16 mm

**50-681**

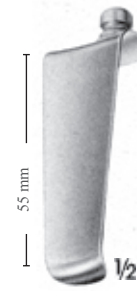


50 mm

1/2

16 mm

**50-682**

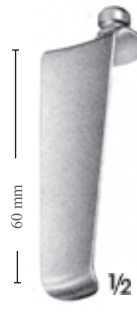


55 mm

1/2

16 mm

**50-683**



60 mm

1/2

16 mm

**50-684**

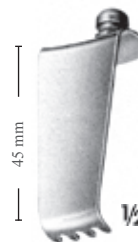


40 mm

1/2

16 mm

**50-685**

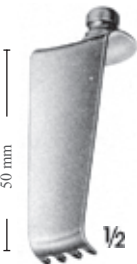


45 mm

1/2

16 mm

**50-686**

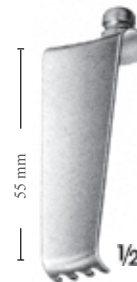


50 mm

1/2

16 mm

**50-687**

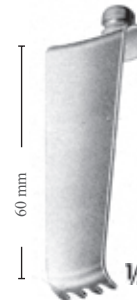


55 mm

1/2

16 mm

**50-688**



60 mm

1/2

16 mm

**50-689**

P28-02 Komple/Complete

11 cm





CLOWARD  
**50-690** 18 mm  
**50-691** 20 mm  
**50-692** 23 mm  
 18 cm



CLOWARD  
**50-693**  
 Koter huku/Coutery hook  
 20 cm



CLOWARD  
**50-694**  
 10 x 8 mm  
 19 cm



CLOWARD  
**50-695**  
 20 x 12 mm  
 20 cm



$\frac{1}{2}$   
 CLOWARD  
**50-696** 230 gr.  
 19 cm



CLOWARD  
**50-697** 5 mm  
**50-698** 8 mm  
**50-699** 10 mm  
**50-700** 12 mm  
 20 cm



CLOWARD  
**50-701**  
 4 mm  
 18 cm



CLOWARD  
**50-702**  
 20 cm





**CLOWARD  
50-703**  
Graft alma kolu  
Dowel cutter shaft  
16.5 cm



**50-704**  
Ø 12 mm



**50-705**  
Ø 14 mm



**50-706**  
Ø 16 mm



**50-707**  
Ø 18 mm

Dowel cutters  
Graft alma matkapları



**50-708**  
Ø 12 mm



**50-709**  
Ø 14 mm



**50-710**  
Ø 16 mm



**50-711**  
Ø 18 mm

Merkezleme pimleri  
Dowel center pins



**50-712**  
Çakma başlığı  
Dowel ejector



**50-713**  
Ø 18 mm



**50-714**  
Ø 16 mm



**50-715**  
Ø 14 mm



**50-716**  
Ø 12 mm

Dowel holders  
Graft tutma uçları



**50-717**  
Tutma kolu  
Dowel handle



**50-718**  
Anahtar  
Wrench



**50-719**  
Tutma kolu  
Dowel handle  
18 cm



**50-720**  
Derinlik ölçer  
Depth gauge  
21 cm



**50-721** Ø 9.5 mm  
Koruyucu kılavuz  
Guard guide  
19 cm



**50-722**  
Ø 13 mm  
Küçük/Small



**50-726** Ø 10 mm

**50-727** Ø 12 mm

**50-728** Ø 14 mm

**50-729** Ø 16 mm

Matkap ucu/Drill tip

**50-723**  
Ø 16 mm  
Büyük/Large

**50-724 - 50-725**  
Matkap kolu  
Drill shaft  
14 cm



**50-733** Ø 22 mm  
Kol içi çapı  
Handle inside diameter



**50-730** Ø 13 mm  
Küçük/Small  
**50-731** Ø 16 mm  
Büyük/Large Matkap  
koruyucu Drill guard



**50-732** Ø 25 mm  
Matkap koruma başlığı  
Drill Guard cap  
3 mm



**50-734**  
Karşı ekartör  
Counter retractor



**50-735**  
Çift hareketli karşı ekartör  
Doble hinged retractor used for  
longitudinal retraction



**50-736**  
Çift hareketli Servikal ekartör  
Doble hinged Cervical retractor



**50-737** 30 x 24 mm  
**50-738** 35 x 24 mm  
**50-739** 40 x 24 mm  
**50-740** 45 x 24 mm  
**50-741** 50 x 24 mm  
**50-742** 55 x 24 mm  
**50-743** 60 x 24 mm  
**50-744** 65 x 24 mm  
**50-745** 70 x 24 mm  
Titanyum orta bleydler  
Mediall blades titanium



**50-746** 30 x 24 mm  
**50-747** 35 x 24 mm  
**50-748** 40 x 24 mm  
**50-749** 45 x 24 mm  
**50-750** 50 x 24 mm  
**50-751** 55 x 24 mm  
**50-752** 60 x 24 mm  
**50-753** 65 x 24 mm  
**50-754** 70 x 24 mm  
Titanyum yan bleydler  
Lateral blades titanium



**50-755** 35 x 24 mm  
**50-756** 40 x 24 mm  
**50-757** 45 x 24 mm  
**50-758** 50 x 24 mm  
**50-759** 55 x 24 mm  
**50-760** 60 x 24 mm  
**50-761** 65 x 24 mm  
**50-762** 70 x 24 mm  
**50-763** 75 x 24 mm  
Titanyum künt bleydler  
Blunt blades titanium



**50-764** 30 x 24 mm  
**50-765** 35 x 24 mm  
**50-766** 40 x 24 mm  
**50-767** 45 x 24 mm  
**50-768** 50 x 24 mm  
**50-769** 55 x 24 mm  
**50-770** 60 x 24 mm  
**50-771** 65 x 24 mm  
**50-772** 70 x 24 mm  
Titanyum orta bleydler  
Mediall blades titanium



**50-773** 30 x 24 mm  
**50-774** 35 x 24 mm  
**50-775** 40 x 24 mm  
**50-776** 45 x 24 mm  
**50-777** 50 x 24 mm  
**50-778** 55 x 24 mm  
**50-779** 60 x 24 mm  
**50-780** 65 x 24 mm  
**50-781** 70 x 24 mm  
Titanyum yan bleydler  
Lateral blades titanium



**50-782** 35 x 24 mm  
**50-783** 40 x 24 mm  
**50-784** 45 x 24 mm  
**50-785** 50 x 24 mm  
**50-786** 55 x 24 mm  
**50-787** 60 x 24 mm  
**50-788** 65 x 24 mm  
**50-789** 70 x 24 mm  
**50-790** 75 x 24 mm  
Titanyum künt bleydler  
Blunt blades titanium



**50-791** 25 x 19 mm  
**50-792** 30 x 19 mm  
**50-793** 35 x 19 mm  
**50-794** 40 x 19 mm  
**50-795** 45 x 19 mm  
**50-796** 50 x 19 mm  
**50-797** 55 x 19 mm  
**50-798** 60 x 19 mm  
Titanyum dişli bleydler  
Teeth blades titanium

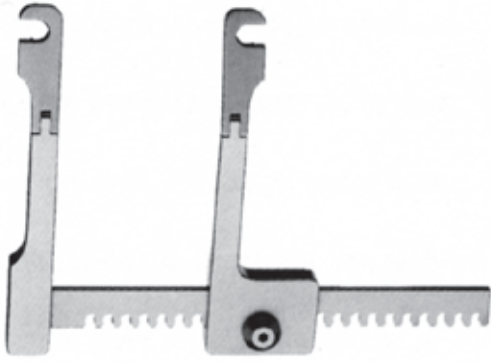


**50-799** 25 x 19 mm  
**50-800** 30 x 19 mm  
**50-801** 35 x 19 mm  
**50-802** 40 x 19 mm  
**50-803** 45 x 19 mm  
**50-804** 50 x 19 mm  
**50-805** 55 x 19 mm  
**50-806** 60 x 19 mm  
Titanyum künt bleydler  
Blunt blades titanium



**50-807**  
Bleyd tutucu elçek  
Handle for blades with side load  
attachment





**50-808**  
Sadece ekartör, 50-809 ile birlikte  
Retractor only, with key 50-809



**50-809**  
Tornavida/Screwdriver  
15 cm



**50-810** 20 x 35 mm  
**50-811** 20 x 40 mm  
**50-812** 20 x 45 mm  
**50-813** 20 x 55 mm  
**50-814** 20 x 65 mm  
Titanyum bleydler  
Blades titanium



**50-815** 40 x 35 mm n  
**50-816** 40 x 40 mm n  
**50-817** 40 x 45 mm n  
**50-818** 40 x 55 mm n  
**50-819** 40 x 65 mm n  
**50-820** 40 x 75 mm n  
Titanyum bleydler Blad  
titanium



**50-821** 60 x 35 mm  
**50-822** 60 x 40 mm  
**50-823** 60 x 45 mm  
**50-824** 60 x 55 mm  
**50-825** 60 x 65 mm  
**50-826** 60 x 75 mm  
**50-827** 60 x 85 mm  
Titanyum bleydler  
Blades titanium



**50-828**  
Hemi-Laminektomi huk, küçük 38 mm  
Hemi-Laminectomy hook, small 38 mm



**50-829**  
Hemi-Laminektomi huk, büyük 58 mm  
Hemi-Laminectomy hook, large 58 mm



**50-830**  
Ekartör bleydleri yerleştirme kolu  
Handle for positioning of the  
retractor blades



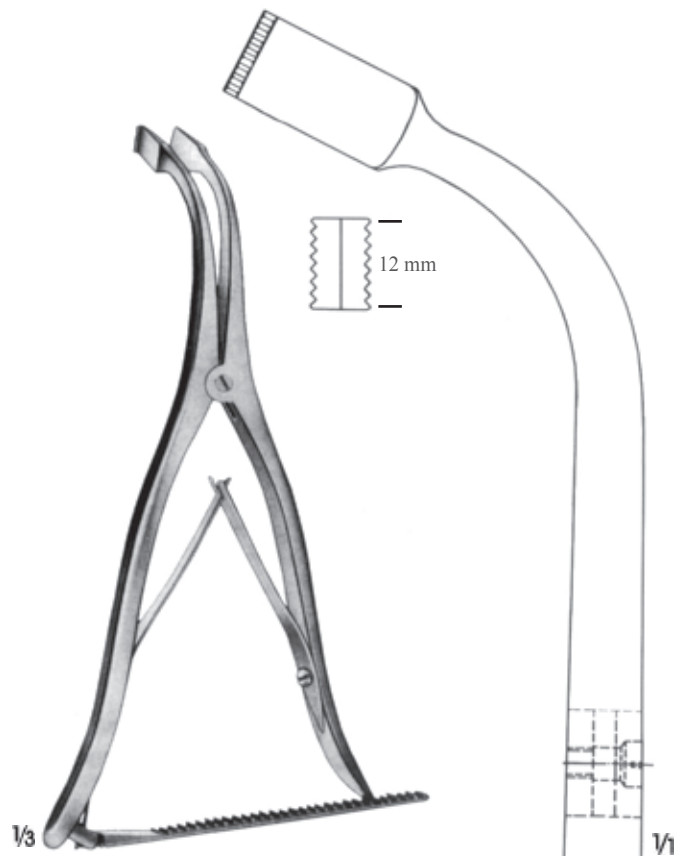
CLOWARD  
50-831  
15.5 cm



CLOWARD  
50-832  
13.5 cm

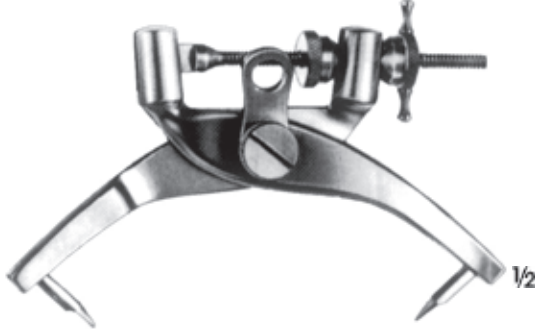


INGE  
50-833  
17 cm



INGE  
50-834  
27.5 cm





CRUTCHFIELD  
50-835  
Çocuklar için/For children



CRUTCHFIELD  
50-836  
Orta boy/Medium size



GARDNER-WELLS  
50-837  
Maksimum açıklık (16 cm)  
Maximum opening (16 cm)



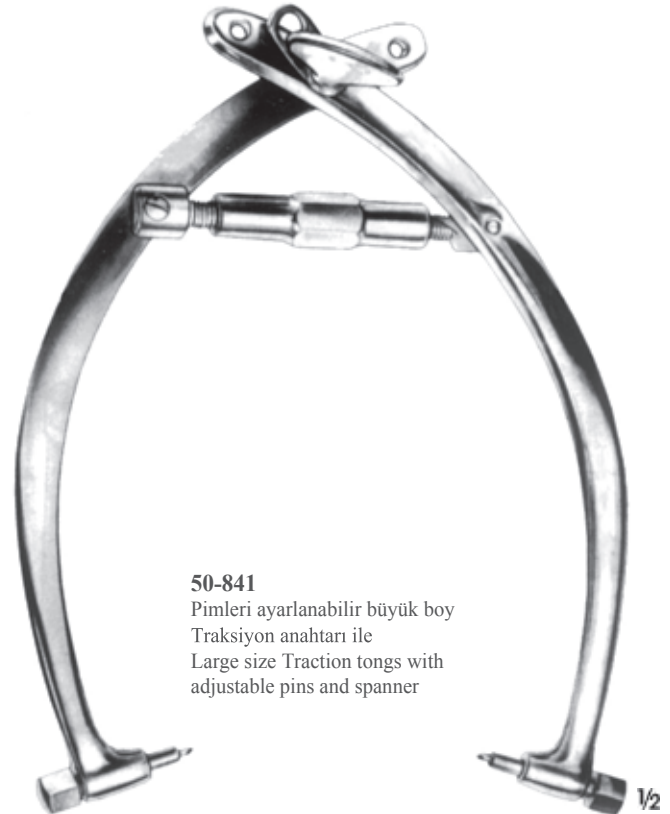
50-838 Matkap  
ucu, büyük Drill  
point, large Ø 5  
mm



50-839  
Matkap ucu, küçük  
Drill point, small  
Ø 3.5 mm



50-840  
Anahtar/wrench



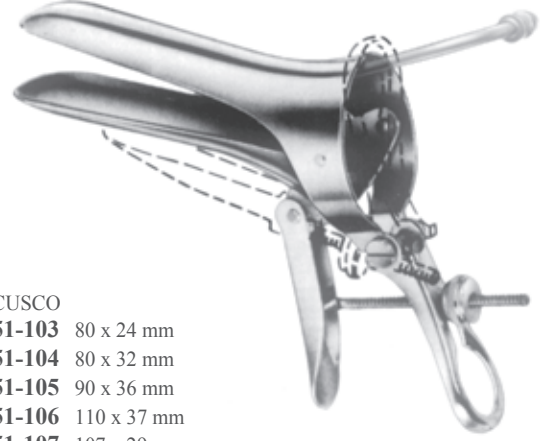
50-841  
Pimleri ayarlanabilir büyük boy  
Traksiyon anahtarı ile  
Large size Traction tongs with  
adjustable pins and spanner



**51**



CUSCO  
**51-100** 80 x 32 mm  
**51-101** 90 x 37 mm  
**51-102** 115 x 37 mm  
Yassı (Ördek gagası)  
Flat (Duck beak)



CUSCO  
**51-103** 80 x 24 mm  
**51-104** 80 x 32 mm  
**51-105** 90 x 36 mm  
**51-106** 110 x 37 mm  
**51-107** 107 x 29 mm  
**51-108** 115 x 35 mm  
Aspiratör uçlu/With suction tube



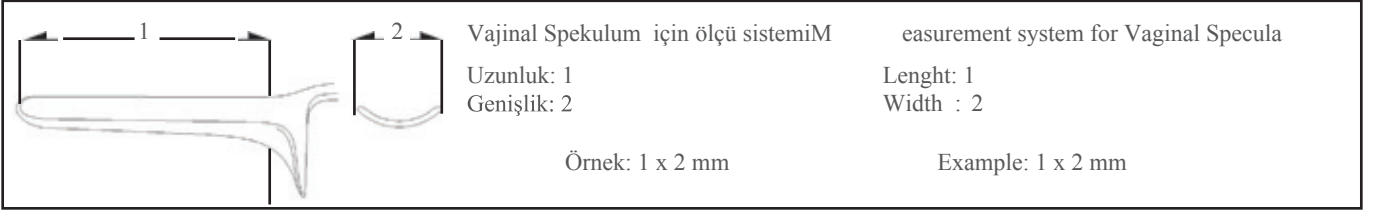
GRAVE  
**51-109** 75 x 20 mm  
**51-110** 95 x 30 mm  
**51-111** 105 x 33 mm



PEDERSON  
**51-112** 100 x 22 mm  
**51-113** 120 x 25 mm



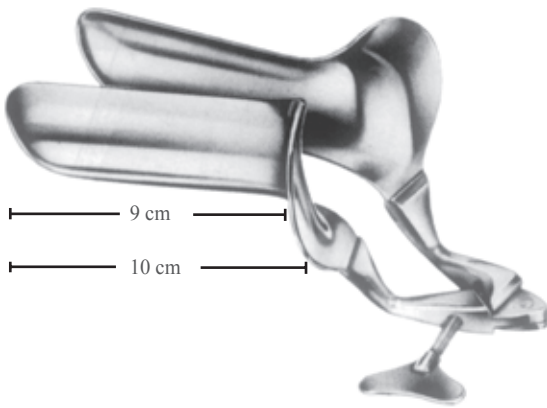




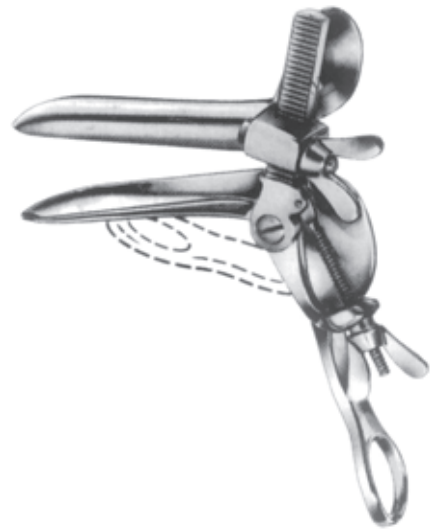
COLLIN  
**51-114**  
53 x 10 mm  
Çocuklar için/For children



COLLIN  
**51-115**  
95/85 x 18 mm  
Bakireler için/For virgins



COLLIN	Tam boy/Çalışma boy Total length/Working length	En Width
<b>51-116</b>	100/90 mm	28 mm
<b>51-117</b>	100/90 mm	32 mm
<b>51-118</b>	105/95 mm	35 mm
<b>51-119</b>	115/105 mm	40 mm



TRELAT

<b>51-120</b>	85 x 33 mm
<b>51-121</b>	95 x 35 mm
<b>51-122</b>	115 x 43 mm





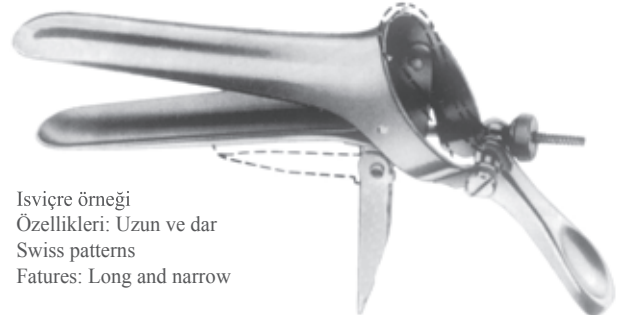
CUSCO  
**51-123**  
75 x 17 mm  
Bakireler için/For virgins



CUSCO  
**51-124**  
75 x 17 mm  
Bakireler için/For virgins



CUSCO STANDARD  
**51-125** 80 x 24 mm  
**51-126** 80 x 32 mm  
**51-127** 90 x 36 mm  
**51-128** 110 x 37 mm  
Standart model Standard  
patterns



İsviçre örneği  
Özellikleri: Uzun ve dar  
Swiss patterns  
Fatures: Long and narrow

CUSCO  
**51-129** 92 x 23 - 25 mm  
**51-130** 100 x 25 - 27 mm  
**51-131** 110 x 27 - 30 mm





Parmak baskısıyla açılıp kapanan çift işaretli  
With double ratchet, closing and opening of  
ratchet by pressure of thumb

SEMM  
**51-132**  
90 x 14 -18 mm  
Çocuk ve bakireler için  
For children and virgins



1/2

Parmak baskısıyla açılıp kapanan çift işaretli  
With double ratchet, closing and opening of  
ratchet by pressure of thumb

SEMM  
**51-133** 100 x 20 - 24 mm  
**51-134** 100 x 30 - 34 mm  
18.5 cm



SEYFFERT  
**51-135** 100 x 17 mm  
**51-136** 100 x 33 mm  
23 cm

Alet ve kataterleri çıkarmak için bir tarafı açık  
One side open for faking up instruments and  
catheters



SEYFFERT  
**51-137** 110 x 33 mm  
23 cm

1/2



Hareketli çeneli  
With movable jaws



1/2

**COLLIN**  
**51-138**  
26.5 cm



1/2

**DARTIGUES**  
**51-139**  
25.5 cm

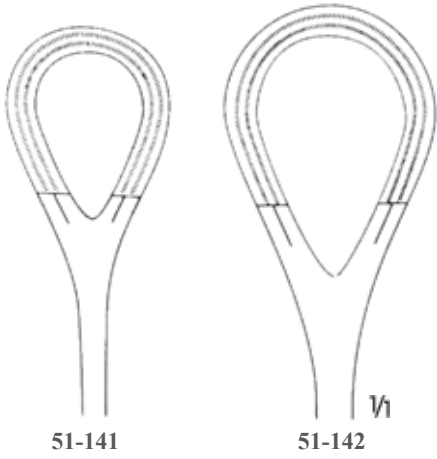


1/2

**SOMER**  
**51-140**  
23.5 cm

Atromatik  
Atraumatic

21 mm      27 mm



51-141 25 cm  
51-142 27 cm



HEYWOOD-SMITH  
51-143  
20 cm



DOYEN  
51-144  
18.5 cm

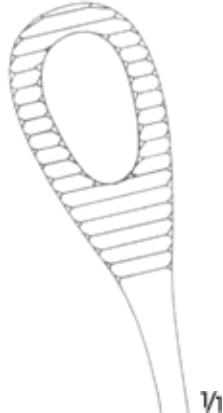




1/1



1/1

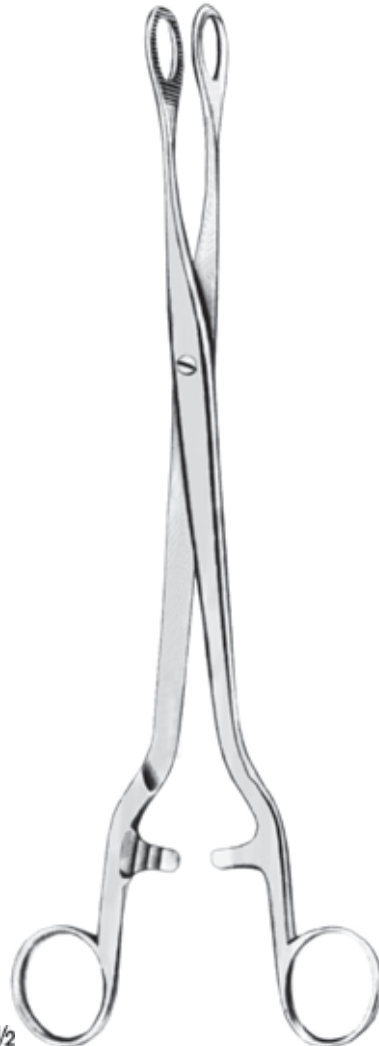


1/1



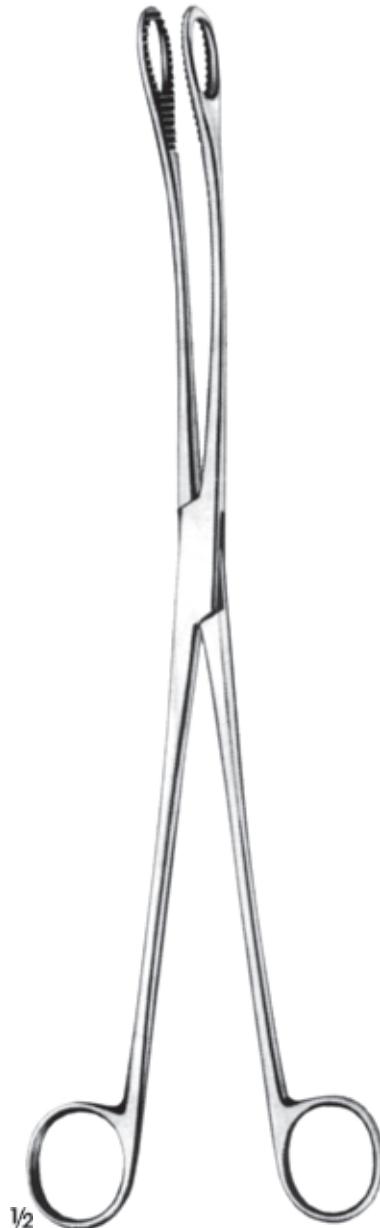
1/2

HEYWOOD-SMITH  
51-145  
25 cm



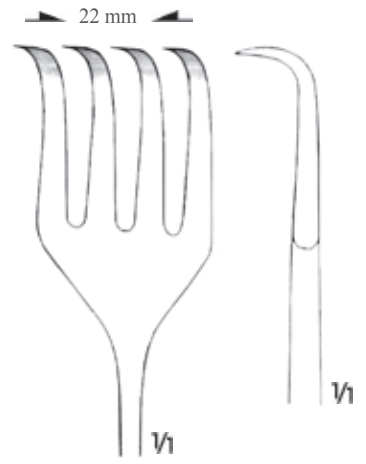
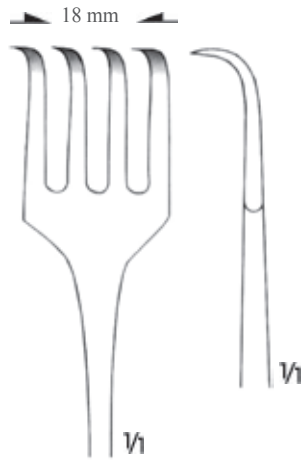
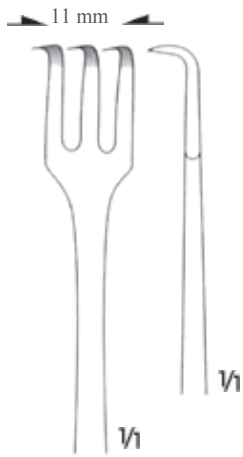
1/2

NOTO  
51-146  
28 cm



1/2

KELLY  
51-147  
32 cm



51-148

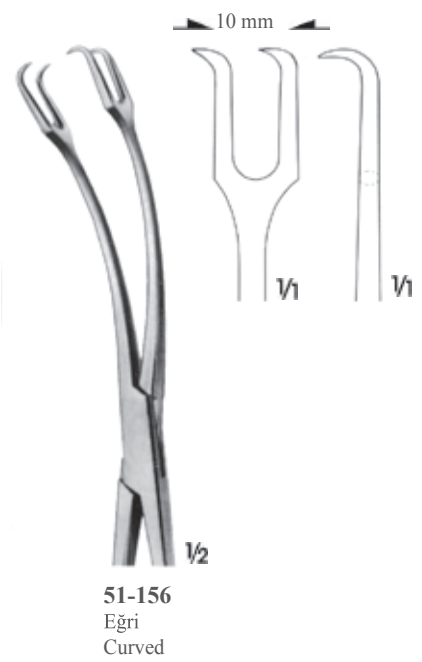
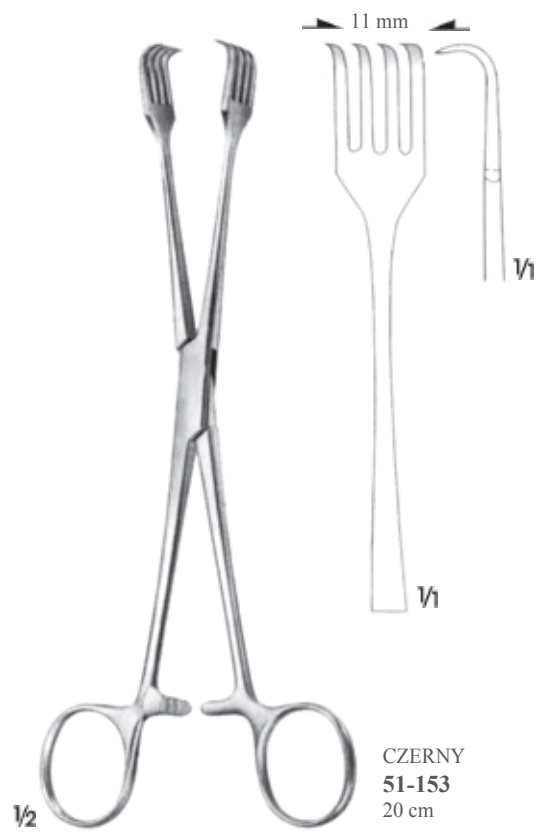
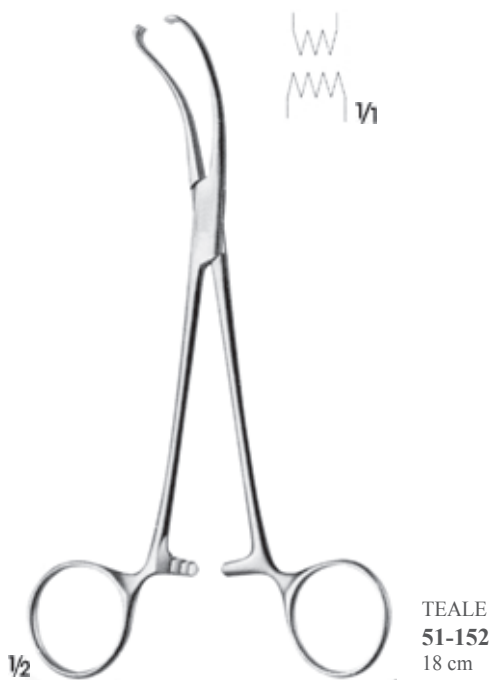


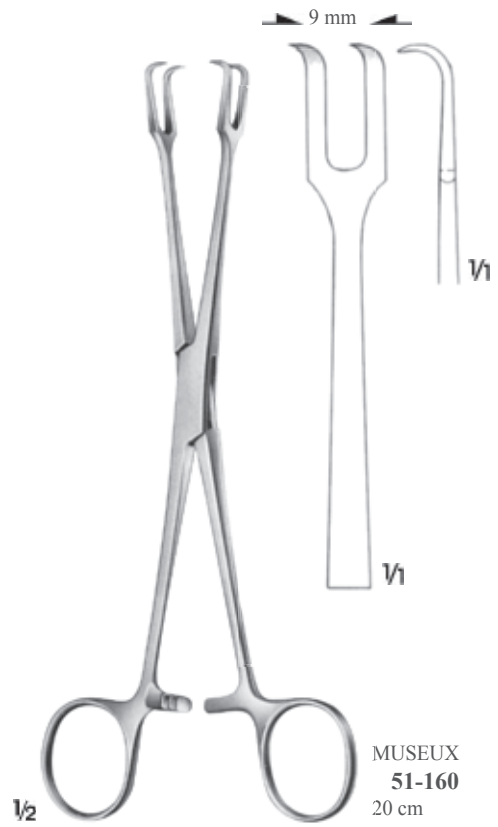
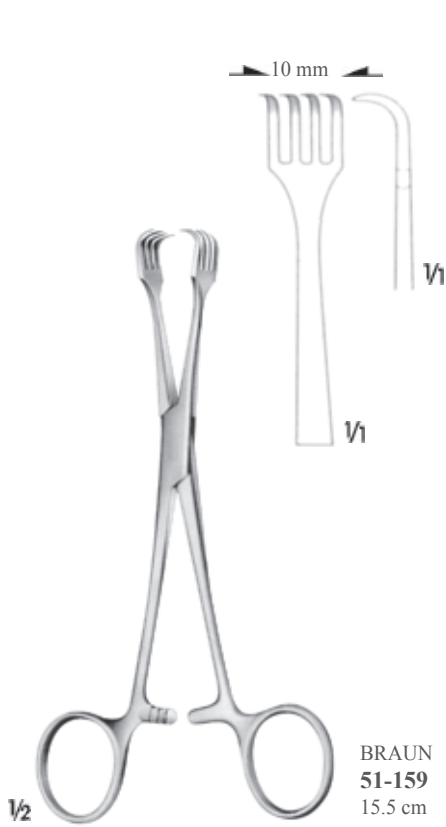
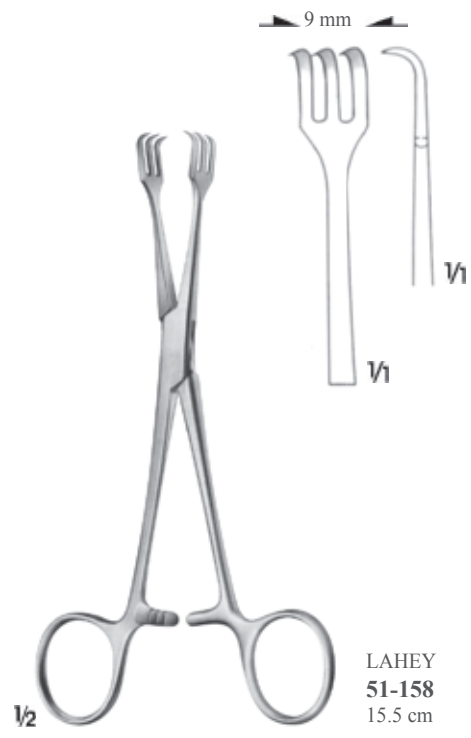
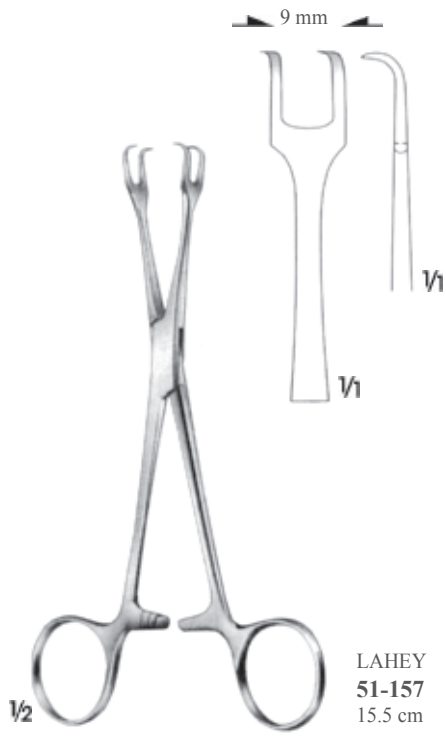
51-149



51-150











LITTLEWOOD  
51-161  
18.5 cm



TEALE  
51-162  
22.5 cm



MUSEUX  
Yana eğri  
Curved to side  
24 cm



KÜSTNER  
51-165  
25 cm



MUSEUX  
51-166  
20 cm



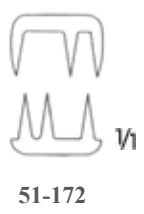
JACOBS  
51-167  
21.5 cm



MUSEUX  
24 cm



MUSEUX  
26.5 cm

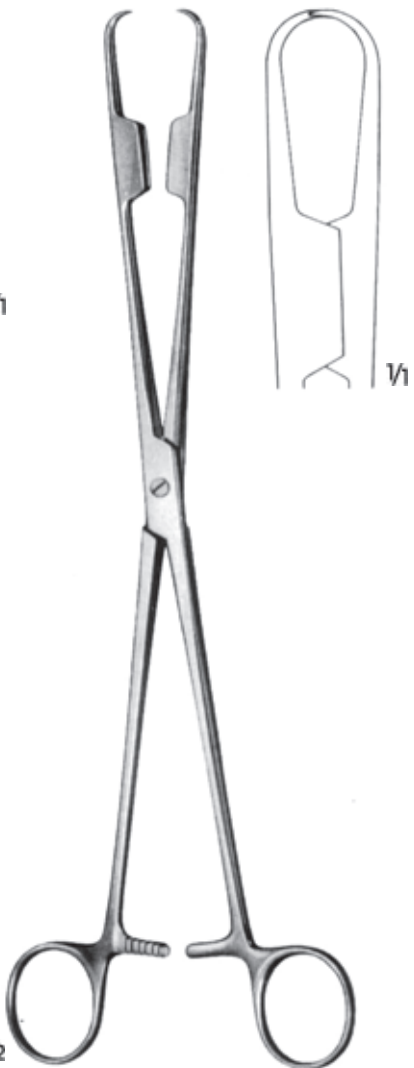




DUBLAY  
51-173  
25 cm



51-174  
26.5 cm

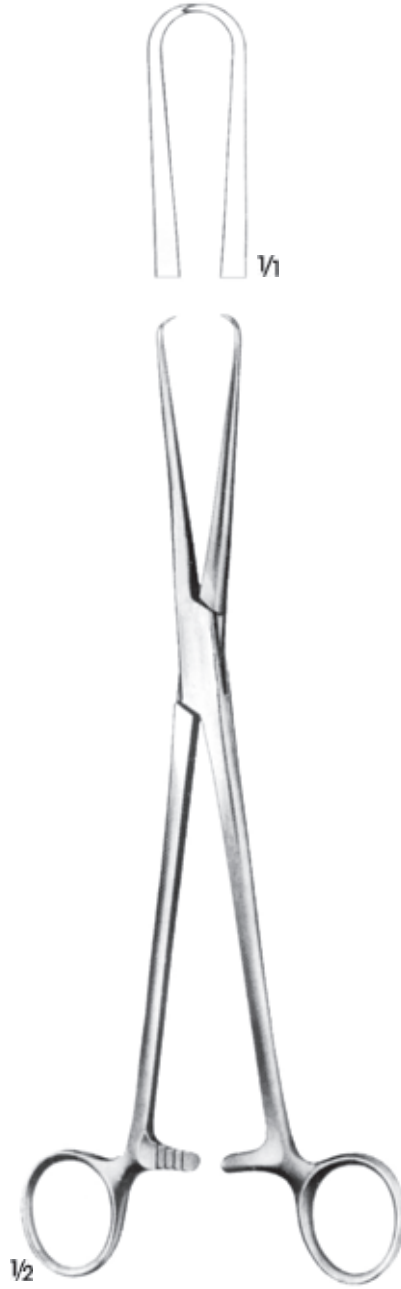


ABEL  
51-175  
28 cm

Uterin Tenekulum Pensleri  
Uterine Tenaculum Forceps



SCHRÖDER  
51-176  
Standart Model  
Standart pattern  
25 cm

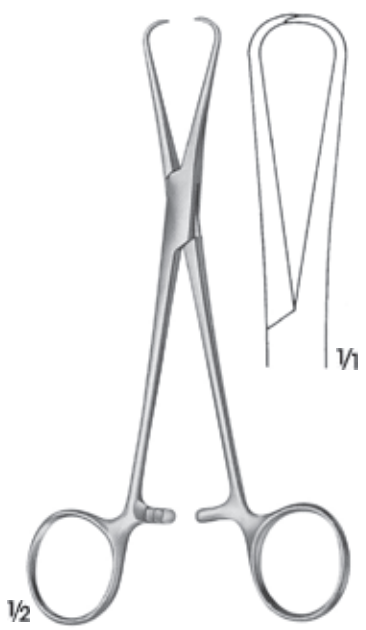


POZZI  
51-177  
Zorlu operasyon için  
Heavy pattern  
25.5 cm



SCHRÖDER  
51-178  
25 cm





**BERNHARD**  
**51-179**  
 16 cm



**POZZI**  
**51-180**  
 17.5 cm



**ADAIR**  
**51-181**  
 19 cm



**BRAUN**  
**51-182**  
 Narin Model/Slender pattern  
 25 cm



**COLLIN-POZZI**  
**51-183**  
 25 cm



**WILSON**  
**51-184**  
 24 cm



**51-185 - 51-186**  
Göbek bağı makaları  
Umbilical cord scissors



**51-185**  
13.5 cm



**51-186**  
16 cm



**SCHUMACHER**  
**51-187**  
Göbek bağı makası  
Umbilical cord scissor  
15.5 cm



**51-188**  
Göbek bağı makası  
Umbilical cord scissors  
10.5 cm



KIEBACK  
**51-189 - 51-190**  
Parametrium makaslar  
Parametrium scissors



**51-189**  
24 cm

**51-190**  
35 cm



KEIBACK  
Parametrium  
makaslar  
1 bleydi küre uclu, yana eğri  
Parametrium scissors, curved to side,  
with 1 probe pointed blade



**51-191**  
26 cm

**51-192**  
35 cm



BRAUN-STADLER  
Epizyotomi makasları  
Episiotomy scissors



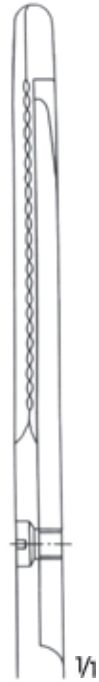
51-193  
14.5 cm



51-194  
20 cm



51-195 Epizyotomi  
makas Episiotomy  
scissors 24 cm



1/2

51-196  
Göbek dilatörü  
Umbilical dilator  
9.5 cm



1/2

COLLIN  
51-197  
Göbek kordonu klempi  
Umbilical cord clamp  
8.5 cm

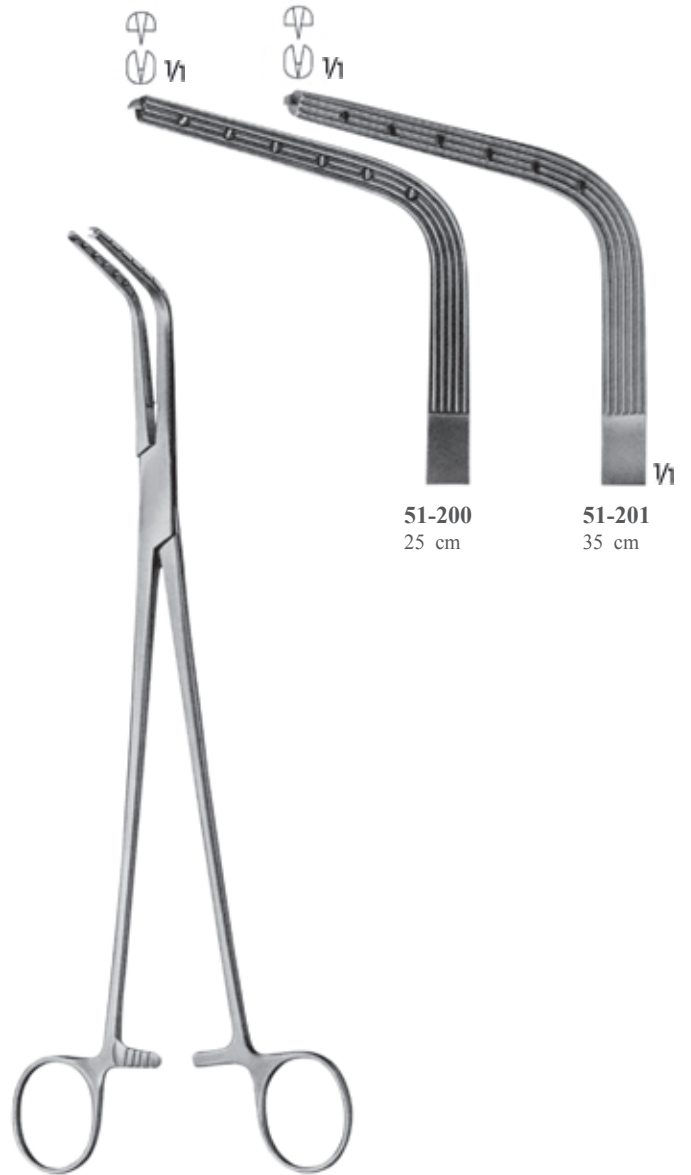






BURKE

Parametriyum pensler, kısa ağızlı  
Parametrium clamps, short jaw part



BURKE

Parametriyum pensler, uzun ağızlı  
Parametrium clamps, long jaw part



Çengel ağız ile daha güvenilir tutuş sağlar.  
Ağız geniş açılabilir.  
Düzgün ve uygun kesme sağlar.  
Deforme olmamış ezilmemiş parça alınmasına imkan verir.  
Travma'ya neden olmaması nedeni ile iyileşme çabuk olur.  
More reliable grip on the tissue due to 'hooking' effect.  
Wide angle of opening.  
Smooth, steady cut.  
Specimens are not squashed.  
Not painful; self-wound, heals well.



51-202



51-203



1/2

SCHUMACHER  
24 cm



51-204  
2 mm



51-205  
2.4 mm



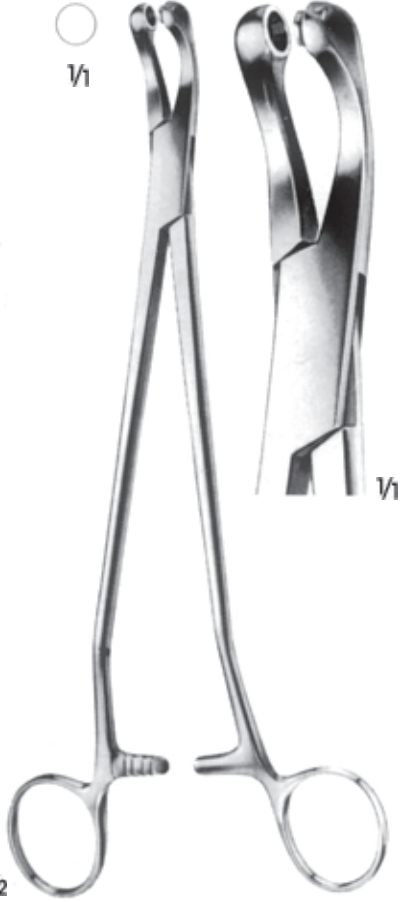
51-206  
2.4 mm



1/2

SEIDL DBP  
Bayonet biyopsi pensleri  
Bayonet-Shaped biopsy forceps  
24 cm





THOMS-GAYLOR  
51-207  
24 cm



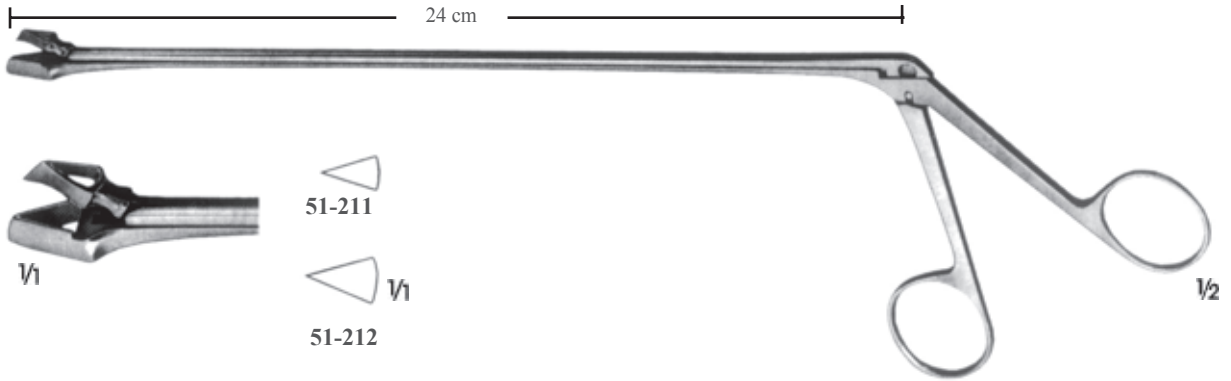
SCHUBERT  
51-208  
26 cm



FAURE  
51-209  
21 cm



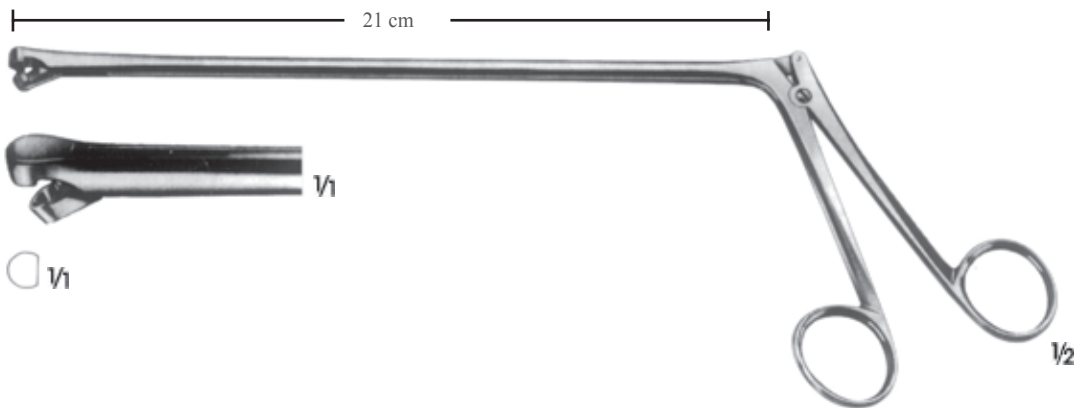
FAURE  
51-210  
24 cm



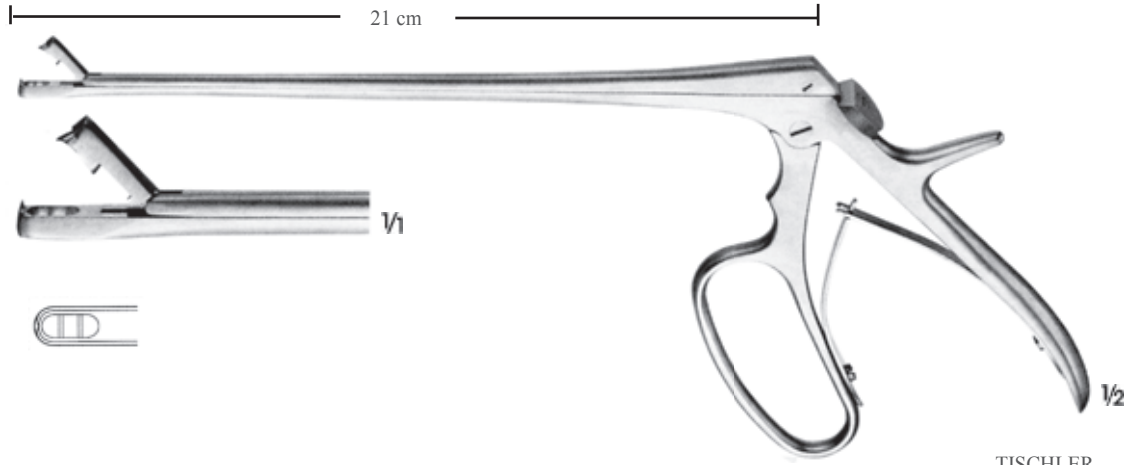
SCHUMACHER  
Kolkoskopi için uygun  
Suitable for colposcopy  
24 cm



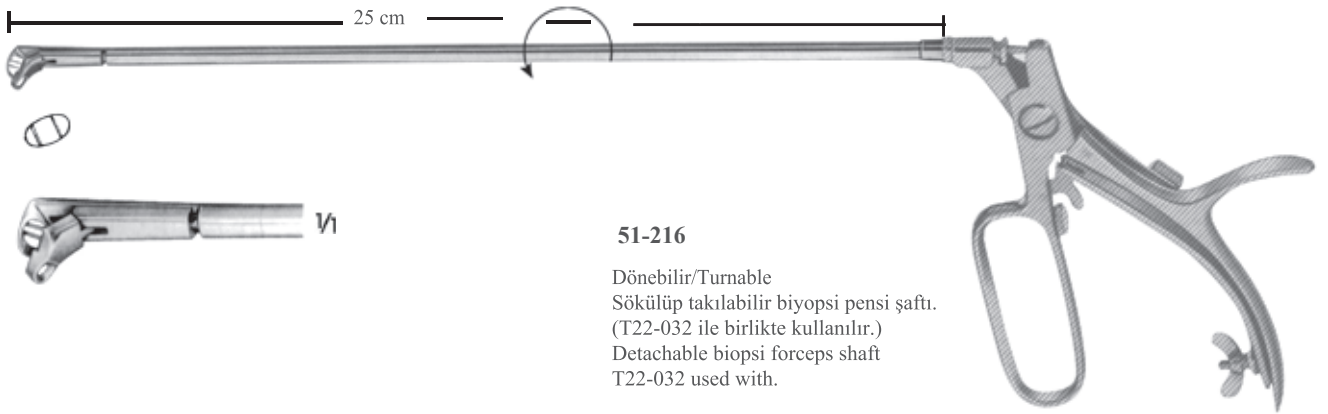
EPPENDORF  
**51-213**  
Kolkoskopi için uygun  
Suitable for colposcopy  
20 cm



BERGER  
**51-214**  
21 cm



TISCHLER  
51-215



51-216

Dönebilir/Turnable  
Sökülüp takılabilir biyopsi pensi shaftı.  
(T22-032 ile birlikte kullanılır.)  
Detachable biopsy forceps shaft  
T22-032 used with.



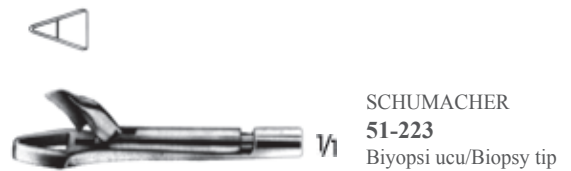
51-217  
Universal sap  
Universal handle  
14 cm

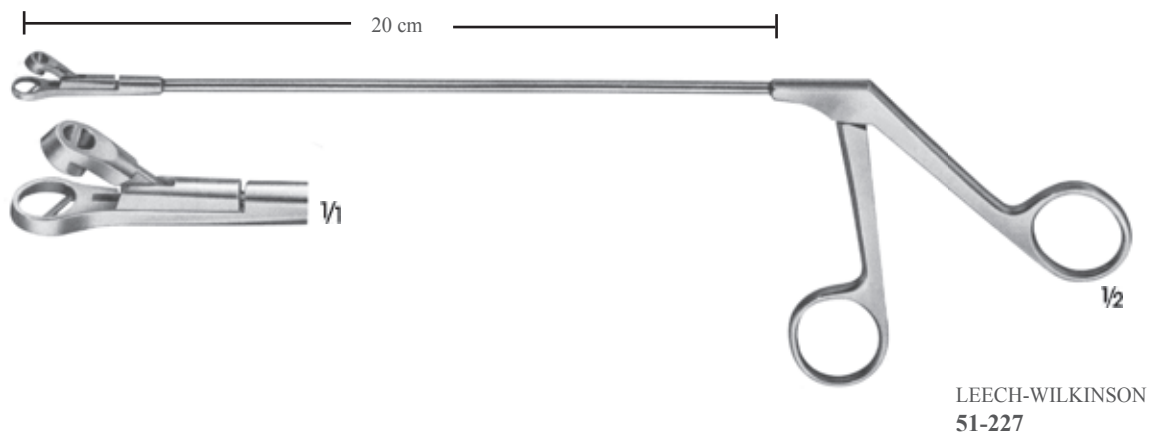
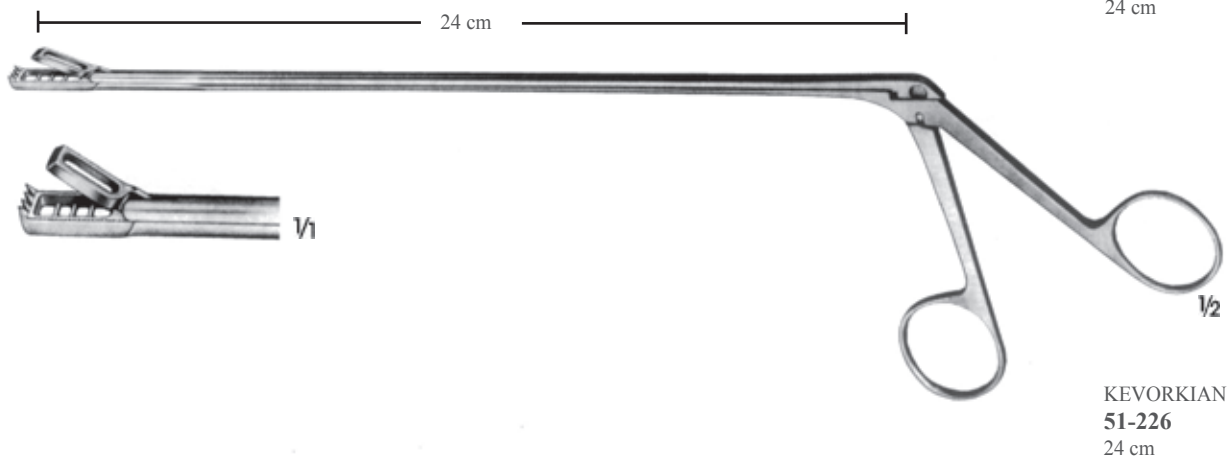
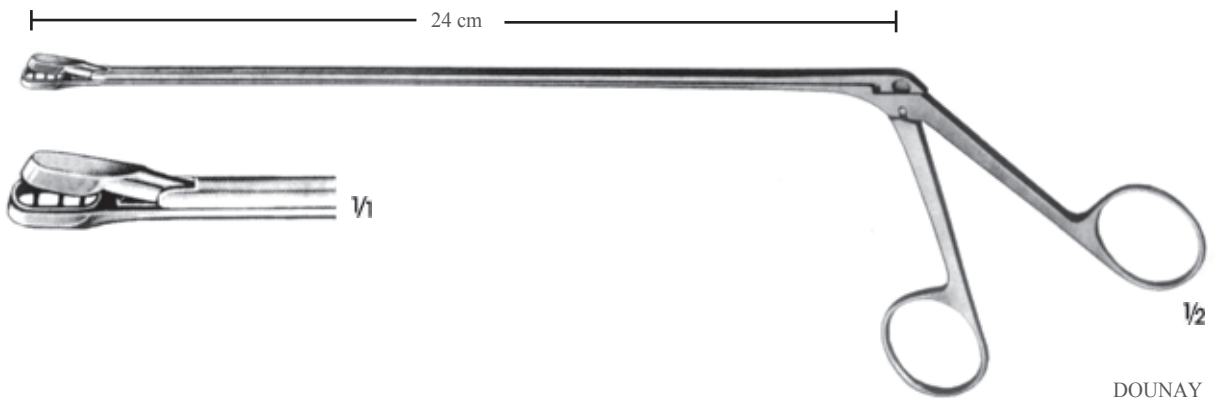
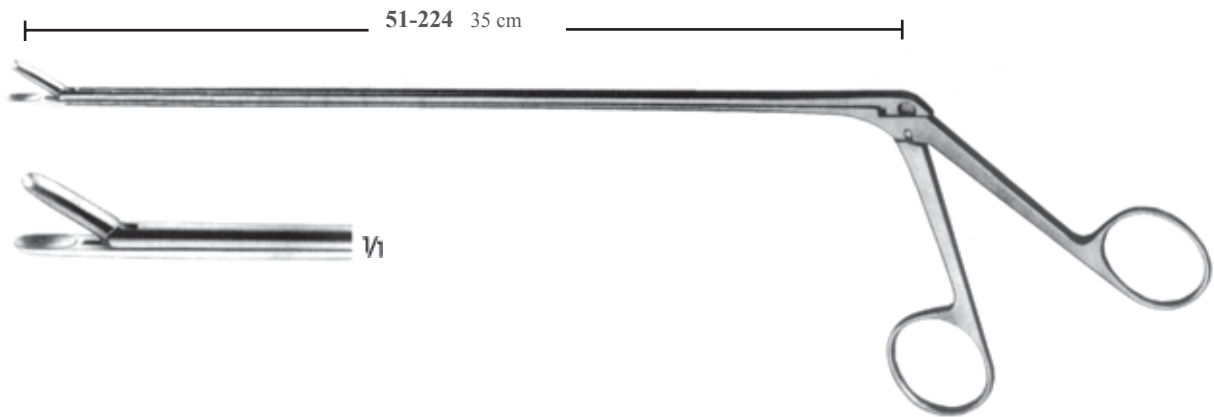


HUBER  
51-218  
Universal sap  
Universal handle  
14 cm



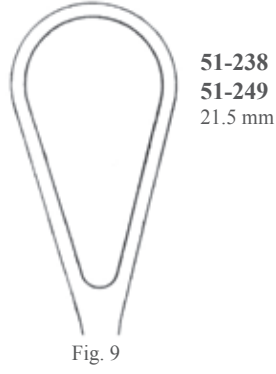
BRÜNNINGS  
51-219 20 cm  
51-220 25 cm  
Uzatma kanülü/Extension cannula





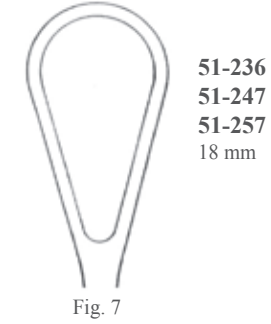


**RECAMIER**  
**51-228 - 51-229**  
 Sivri-Rijid/Sharp-Rigid  
**51-240 - 51-250**  
 Sivri-Bükülebilir/Sharp-Malleable  
**51-251 - 51-258**  
 Künt-Rijid/Blunt-Rigid  
 30 cm



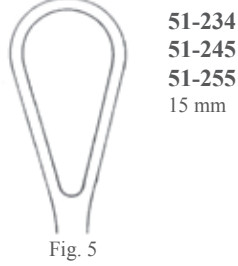
**51-238**  
**51-249**  
 21.5 mm

Fig. 9



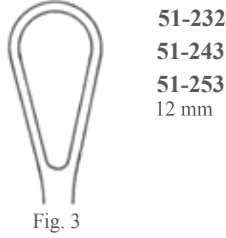
**51-236**  
**51-247**  
**51-257**  
 18 mm

Fig. 7



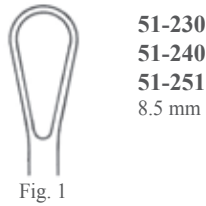
**51-234**  
**51-245**  
**51-255**  
 15 mm

Fig. 5



**51-232**  
**51-243**  
**51-253**  
 12 mm

Fig. 3



**51-230**  
**51-240**  
**51-251**  
 8.5 mm

Fig. 1



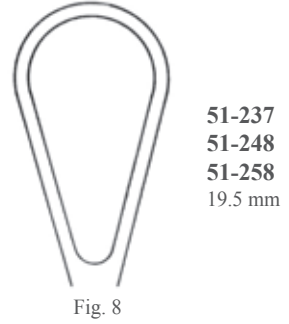
**51-228**  
 4.5 mm

Fig. 00F



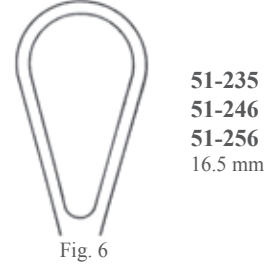
**51-239**  
**51-250**  
 23.5 mm

Fig. 10



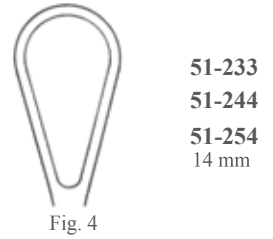
**51-237**  
**51-248**  
**51-258**  
 19.5 mm

Fig. 8



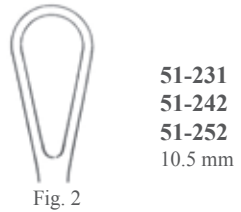
**51-235**  
**51-246**  
**51-256**  
 16.5 mm

Fig. 6



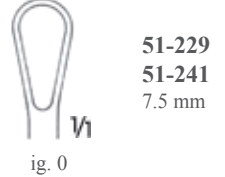
**51-233**  
**51-244**  
**51-254**  
 14 mm

Fig. 4



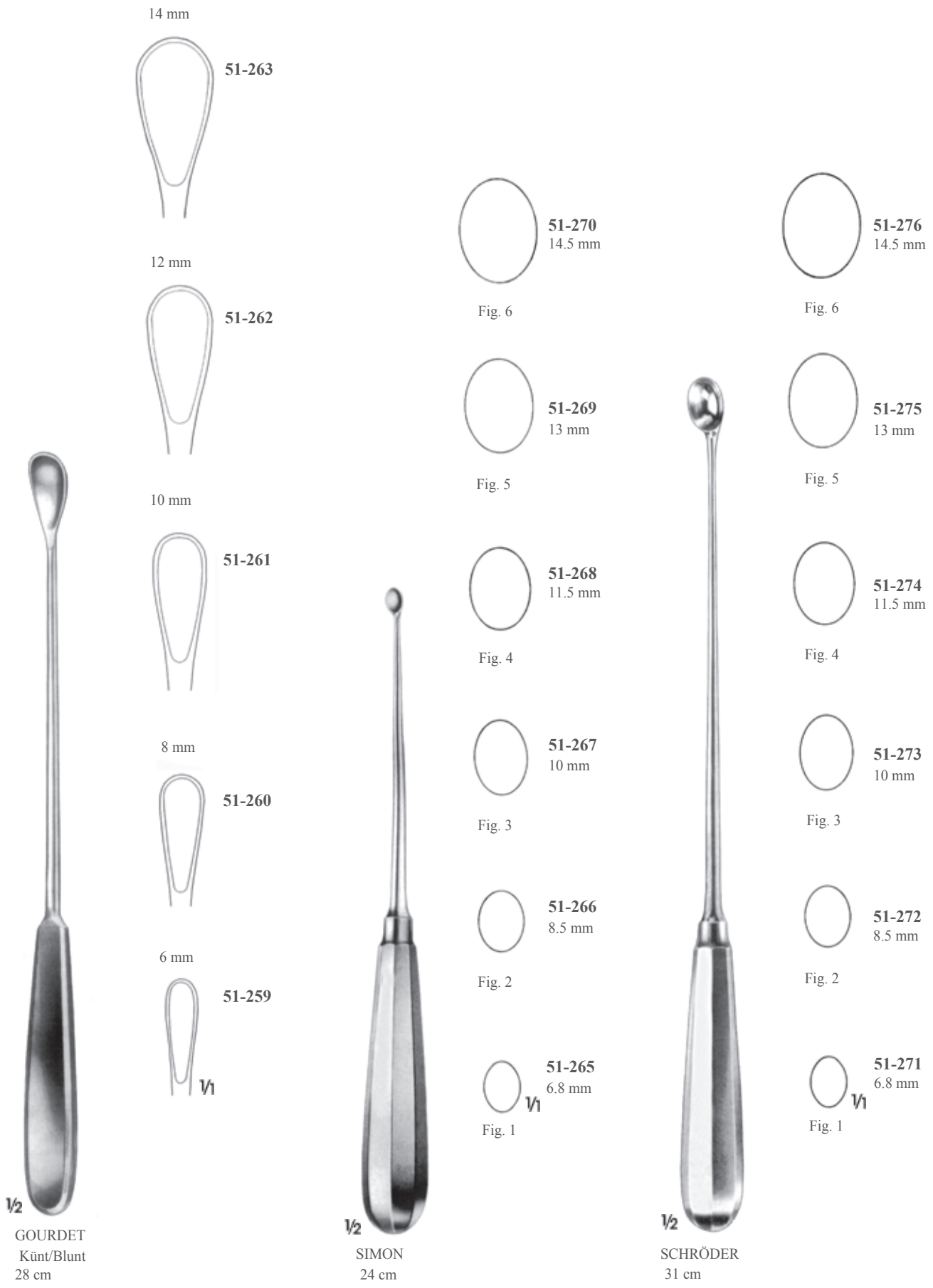
**51-231**  
**51-242**  
**51-252**  
 10.5 mm

Fig. 2



**51-229**  
**51-241**  
 7.5 mm

Fig. 0







**51-282**  
**51-288**  
**51-294**  
15 mm

Fig 6



**51-298**  
28.5 mm

Fig 6



**51-281**  
**51-287**  
**51-293**  
14 mm

Fig 5



**51-297**  
23.5 mm

Fig 4



**51-301**  
26 mm

Fig 5



**51-280**  
**51-286**  
**51-292**  
12 mm

Fig 4



**51-296**  
19.5 mm

Fig 2



**51-300**  
21.5 mm

Fig 3



**51-279**  
**51-285**  
**51-291**  
10.5 mm

Fig 3



**51-278**  
**51-284**  
**51-290**  
8.5 mm

Fig 2



**51-277**  
**51-283**  
**51-289**  
7.5 mm

Fig 1



**51-295**  
16 mm

Fig. 0



**51-299**  
18 mm

Fig. 1

SIMS

**51-277 - 51-282**

Sivri-Rijid/Sharp-Rigid

**51-283 - 51-288**

Sivri-Bükülebilir/Sharp-Malleable

**51-289 - 51-294**

Künt-Rijid/Blunt-Rigid

25.5 cm

BUMM

**51-295 - 51-301**

Künt-Bükülebilir/Blunt-Malleable

29 cm

1/2

1/2

SCHULZE  
51-304  
Uç/Tip



SCHULZE  
51-306  
Uç/Tip



51-305  
Uç/Tip



SCHULZE  
51-302  
37.5 cm

1/2

SCHULZE  
51-303 Komple/Complete  
Salpengografi için uterin kanül  
Salpingography uterine cannula



1/2

LEECH-WILKINSON  
Uterin kanül  
Uterine cannula  
26.5 cm



1/1

51-309  
Büyük/Large  
Ø 16 x 30 mm



1/1

51-308  
Orta/Medium  
Ø 13 x 30 mm



1/1

51-307  
Küçük/Small  
Ø 10 x 25 mm



1/2

51-310  
Rahim kanülü, büyük ve küçük  
2 adet değiştirilebilir konik uçları ile  
Uterine cannula with spring  
connector, self-retaining complete with  
2 interchangeable cones large and small  
25 cm





**SPACKMAN**  
**51-311** Ayarlanabilir  
plaka ile vulsllum pensi  
With adjustable plate for  
vulsllum forceps  
36 cm

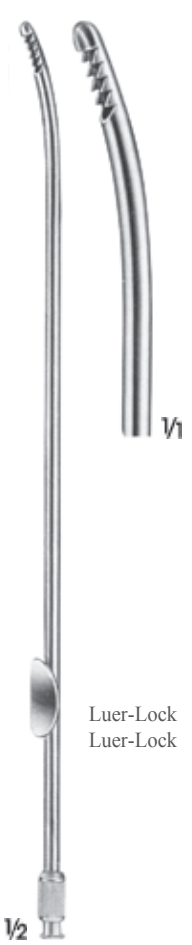


**BEHRMAN**  
**51-312**  
Konik ucu çıkartılabilir  
uterin kanülü  
Uterine cannula with  
detachable cone  
30.5 cm



**ROTUNDA**  
**51-313**  
İrrigasyon kanülü  
Irrigation cannula  
20 cm





**NOVAK-SCHOECKAERT**  
**51-314**  
Biyopsi küreti  
Biopsy curette  
24 cm



**RANDALL**  
**51-315**  
Biyopsi küreti  
Biopsy curette  
24 cm



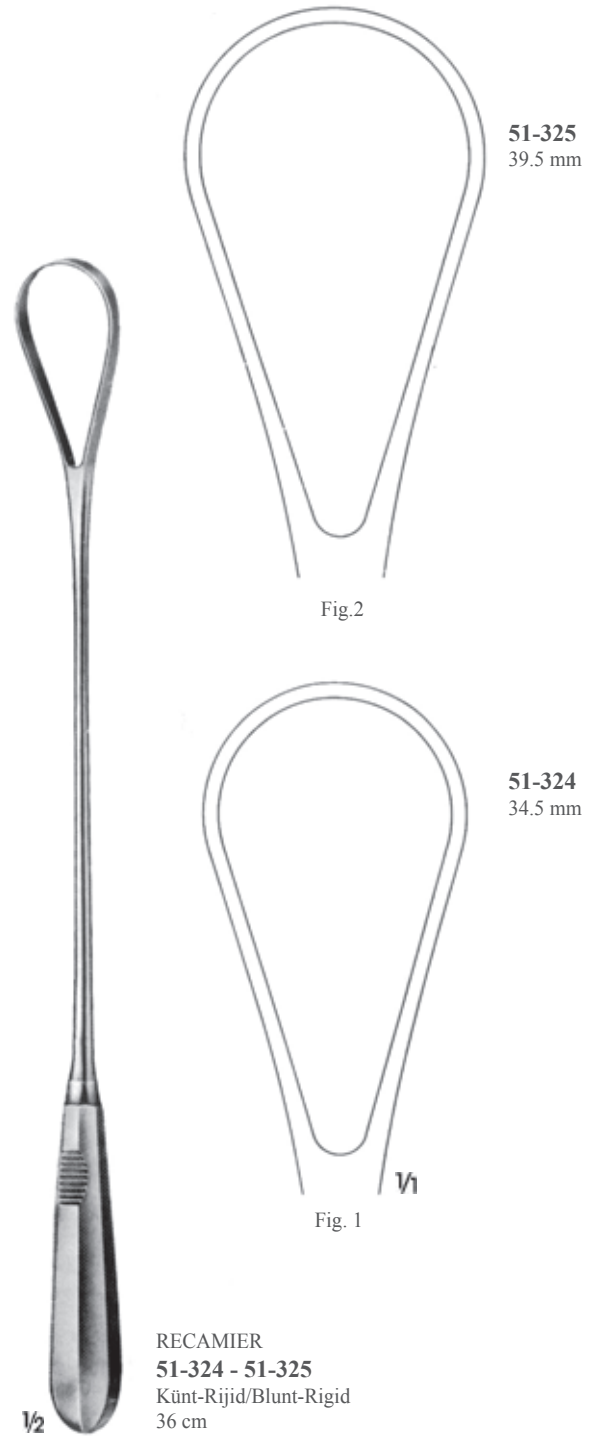
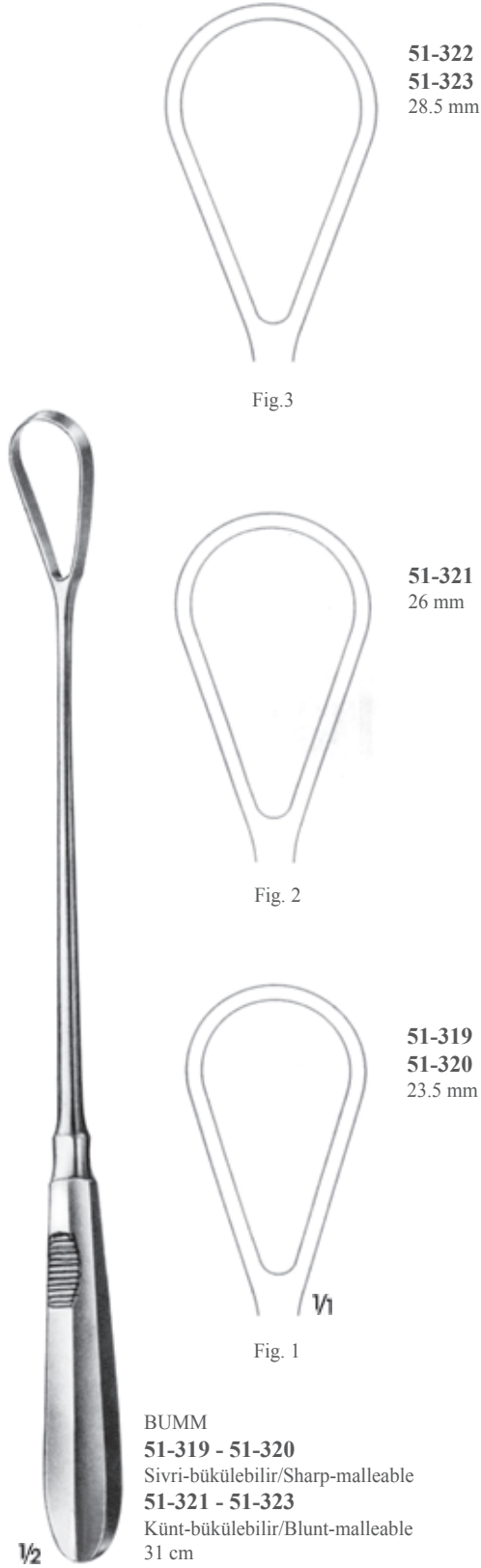
**BERLIN**  
**51-316**  
Biyopsi küreti  
Biopsy curette  
27 cm



**MÜNCHEN**  
**51-317**  
Biyopsi küreti  
Biopsy curette  
27 cm



**ASCH**  
**51-318**  
Kaşık/Scoop  
20 cm





Künt/Blunt

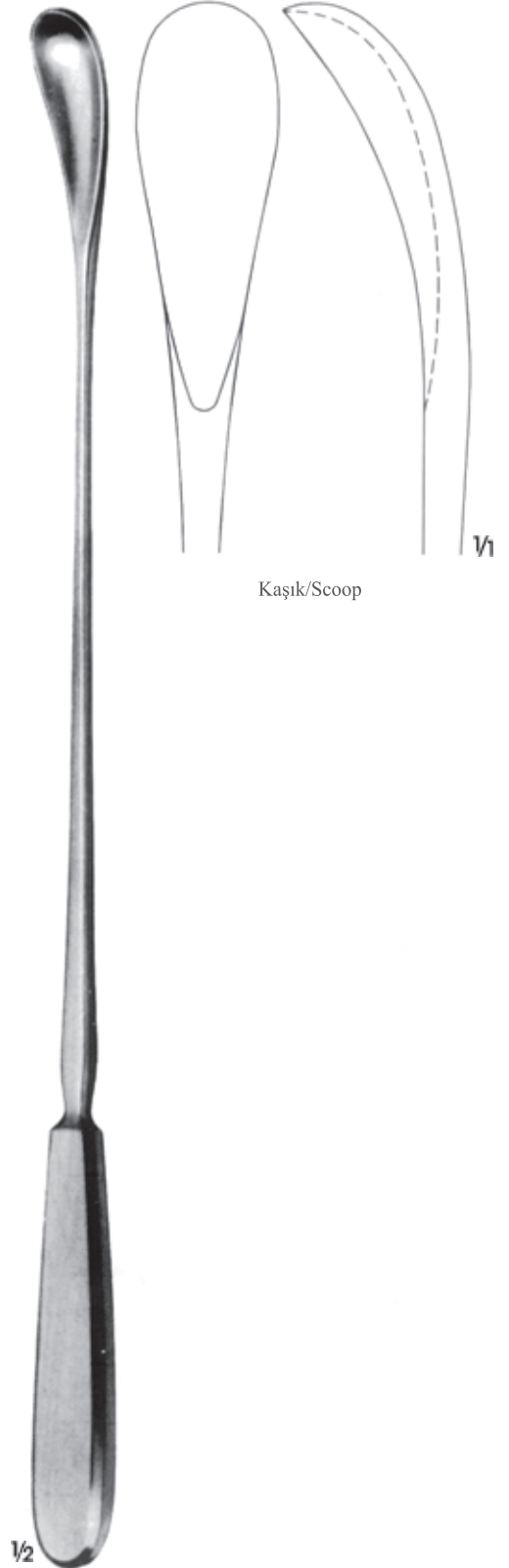
BLAKE  
51-326  
27.5 cm



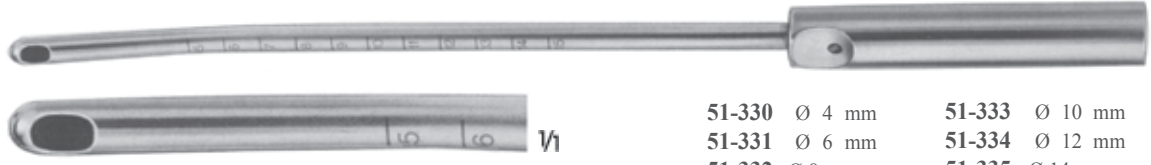
HEANEY  
51-327  
24 cm



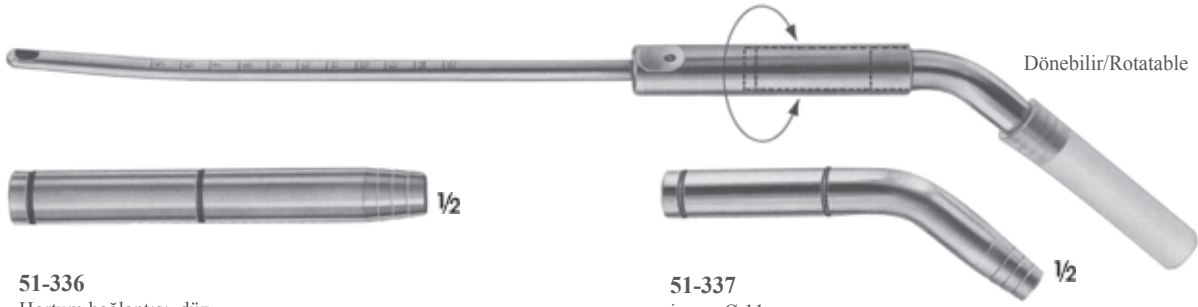
COLLIN  
51-328  
30 cm



WALLICH  
51-329  
42 cm



51-330 Ø 4 mm      51-333 Ø 10 mm  
51-331 Ø 6 mm      51-334 Ø 12 mm  
51-332 Ø 8 mm      51-335 Ø 14 mm



51-336  
Hortum bağlantısı, düz  
Hose connection, straight  
iç çap Ø 11 mm  
inside diam Ø 11mm

51-337  
iç çap Ø 11 mm  
inside diam Ø 11mm



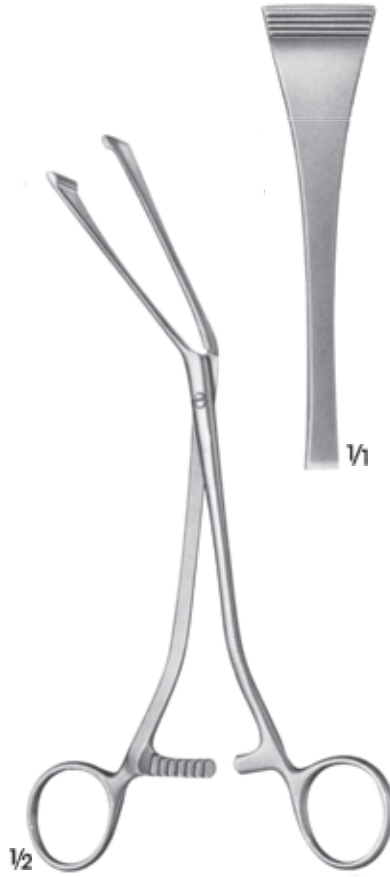
51-338 40 mm  
51-339 50 mm  
51-340 60 mm  
Çekme kolu ile birlikte  
With traction handle  
134°C Otoklav edilebilir  
134°C Autoclavable



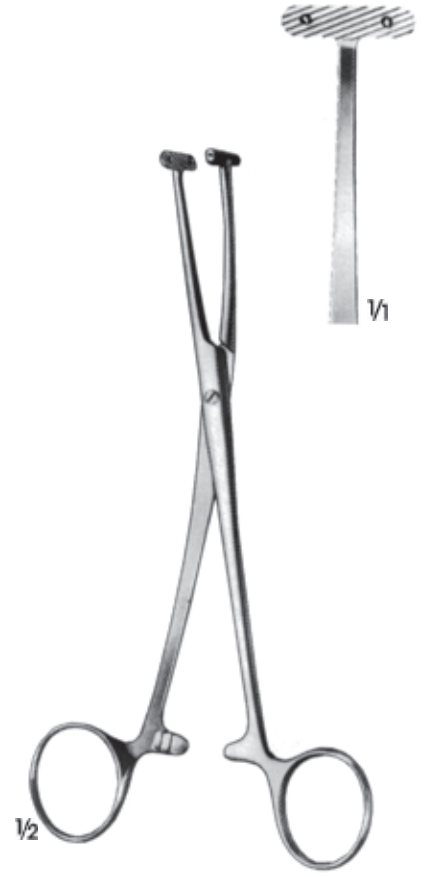
51-341  
El vanası ve bağlantı borusu  
20 cm uzunluğunda bağlantı borusu  
Hand valve with connection hose  
20 cm long connection hose



**GREEN-ARMYTAGE  
51-342**  
Sezeryan hemostatik pens düz  
Caesarean hemostatic forceps,  
straight  
22 cm



**GREEN-ARMYTAGE  
51-343**  
Sezeryan hemostatik pens, açılı  
Caesarean hemostatic forceps,  
angled  
19.5 cm



**WILLETT  
51-344**  
Kafa derisi tutucu pens  
Scalp flap forceps  
18.5 cm





SAENGER  
51-345  
26.5 cm

SAENGER  
51-346  
27.5 cm

SAENGER  
51-347  
28.5 cm



51-348 51-349  $\frac{1}{2}$



51-350 51-351 51-352  $\frac{1}{2}$



51-353 51-354  $\frac{1}{2}$



$\frac{1}{2}$  WINTER  
29 cm



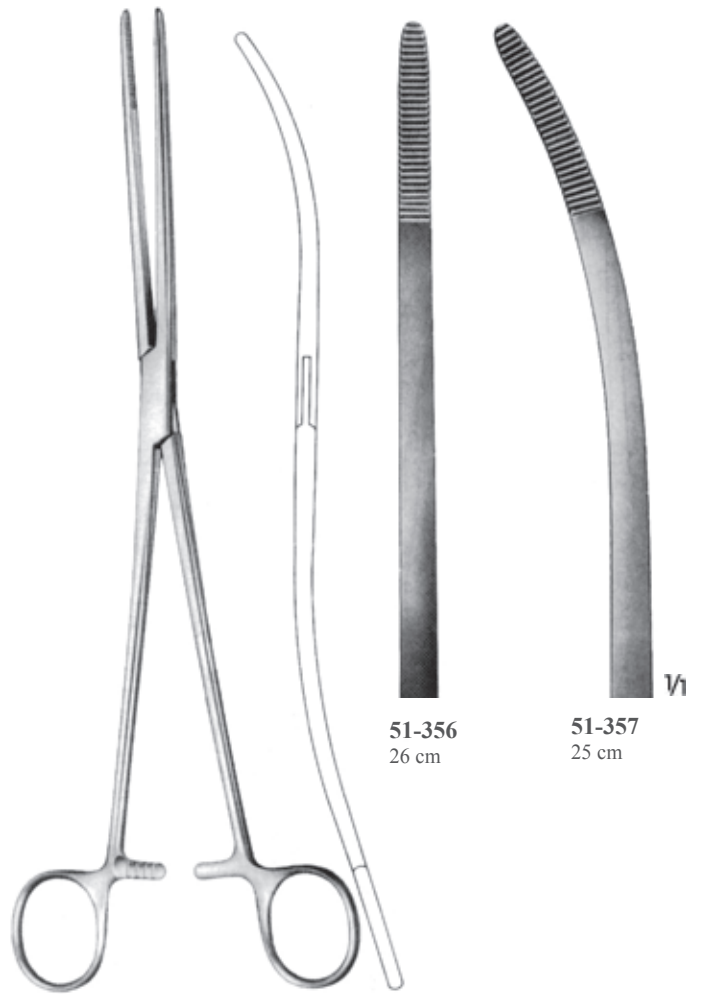
$\frac{1}{2}$  WINTER  
29 cm



$\frac{1}{2}$  WINTER  
Kilitli/With ratchet  
29 cm



BOZEMANN-DOUGLAS  
51-355  
26 cm



BOZEMANN  
51-356 - 51-357

51-356  
26 cm

51-357  
25 cm

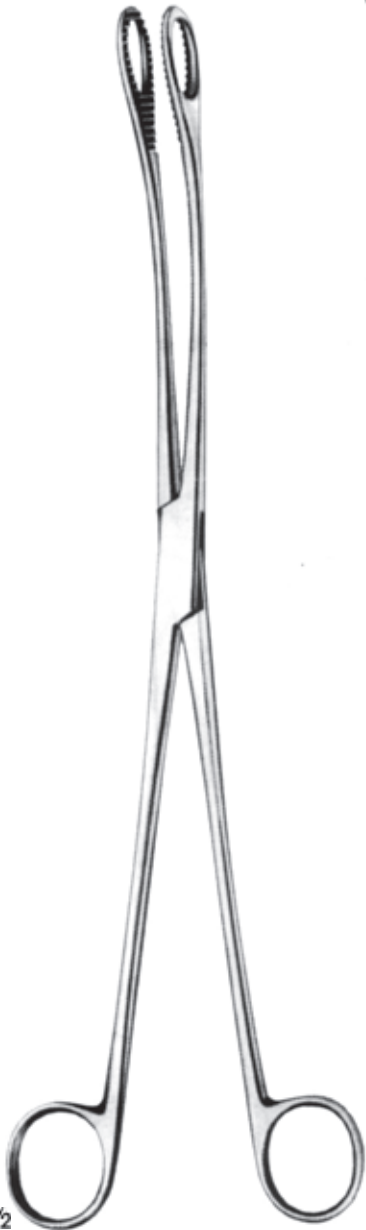




**SMELLIE**  
51-358  
27 cm



**LEWKOWITZ**  
51-359 - 51-360  
24.5 cm



KELLY  
51-361  
32 cm



MC. CLINTOCK  
51-362  
24 cm



51-363  
28.5 cm



Koruyucu, kapaklı  
With protecting cap



<b>51-364</b>	1 mm	<b>51-377</b>	14 mm	<b>51-390</b>	1.5 mm	<b>51-403</b>	14.5 mm
<b>51-365</b>	2 mm	<b>51-378</b>	15 mm	<b>51-391</b>	2.5 mm	<b>51-404</b>	15.5 mm
<b>51-366</b>	3 mm	<b>51-379</b>	16 mm	<b>51-392</b>	3.5 mm	<b>51-405</b>	16.5 mm
<b>51-367</b>	4 mm	<b>51-380</b>	17 mm	<b>51-393</b>	4.5 mm	<b>51-406</b>	17.5 mm
<b>51-368</b>	5 mm	<b>51-381</b>	18 mm	<b>51-394</b>	5.5 mm		
<b>51-369</b>	6 mm	<b>51-382</b>	19 mm	<b>51-395</b>	6.5 mm		
<b>51-370</b>	7 mm	<b>51-383</b>	20 mm	<b>51-396</b>	7.5 mm		
<b>51-371</b>	8 mm	<b>51-384</b>	21 mm	<b>51-397</b>	8.5 mm		
<b>51-372</b>	9 mm	<b>51-385</b>	22 mm	<b>51-398</b>	9.5 mm		
<b>51-373</b>	10 mm	<b>51-386</b>	23 mm	<b>51-399</b>	10.5 mm		
<b>51-374</b>	11 mm	<b>51-387</b>	24 mm	<b>51-400</b>	11.5 mm		
<b>51-375</b>	12 mm	<b>51-388</b>	25 mm	<b>51-401</b>	12.5 mm		
<b>51-376</b>	13 mm	<b>51-389</b>	26 mm	<b>51-402</b>	13.5 mm		

1/2

HEGAR  
51-64 - 51-406 Sivri  
uclu dilatörler With  
very conical point 18.5  
cm



1/2

PRATT  
51-407 - 51-414  
29 cm

<b>51-407</b>	13 - 15 Charr.
<b>51-408</b>	17 - 19 Charr.
<b>51-409</b>	21 - 23 Charr.
<b>51-410</b>	25 - 27 Charr.
<b>51-411</b>	29 - 31 Charr.
<b>51-412</b>	33 - 35 Charr.
<b>51-413</b>	37 - 39 Charr.
<b>51-414</b>	41 - 43 Charr.



1/2

HEGAR  
51-415 - 51-423  
19.5 cm

<b>51-415</b>	1 + 2 mm
<b>51-416</b>	3 + 4 mm
<b>51-417</b>	5 + 6 mm
<b>51-418</b>	7 + 8 mm
<b>51-419</b>	9 + 10 mm
<b>51-420</b>	11 + 12 mm
<b>51-421</b>	13 + 14 mm
<b>51-422</b>	15 + 16 mm
<b>51-423</b>	17 + 18 mm



UCHIDA  
51-424 27 cm  
51-425 35 cm  
Kaşıklar/Spoons



KEIBACK  
51-426 23.5 cm  
51-427 35 cm  
Yan kavisli üretal tünel pensleri  
Ureteral tunnel clamps, curved to side



51-426  
23.5 cm



51-427  
35 cm





MAYO  
51-428 Bükülebilir/  
Malleable 33 cm



SIMS  
51-429 33 cm  
51-430 33 cm  
Bükülebilir/Malleable



51-431  
30 cm



SIMPSON  
51-432  
Bükülebilir, gümüş kaplama  
Malleable, silver-plated  
31 cm







**BRAUN**  
**51-433**  
Uterin bastırıcı  
Uterine depressor  
27 cm

Ø 3.6 mm



**GALABINS**  
**51-434**  
Ölçülü mil, bükülebilir  
Shaft graduated in cm, malleable  
29.5 cm

Ø 4 mm



**VALLEIX**  
**51-435**  
Ölçü kaydırıcı, göstergeli  
Graduated, with slider  
25 cm



**MARTIN**  
**51-436**  
Santimetre ölçülü  
Graduated in centimeters



**DE LEE**  
**51-437**  
Pelvimetre santimetre ve inç ölçülü  
Pelvimeter centimeters and inches  
measured



1/2

DOYEN  
51-438  
Myoma burgusu  
Myoma screw  
19 cm



1/2

DOYEN  
51-439  
Myoma burgusu  
Myoma screw  
15 cm

1/4



GELPI  
51-440  
13.5 cm



GELPI  
51-441  
17.5 cm



RICHTER  
51-442  
17 cm



JOLL (FRIEDMANN)  
51-443  
15.5 cm



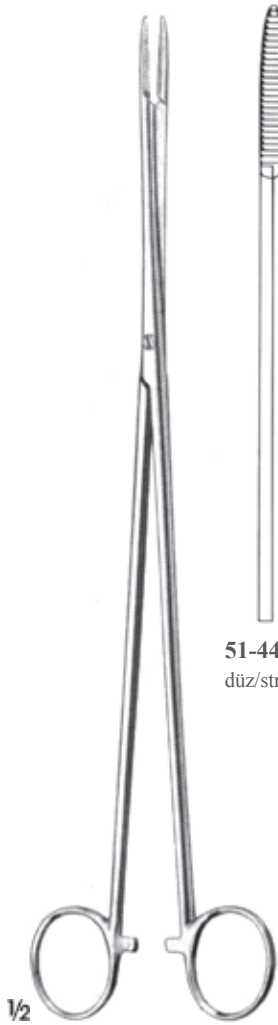


BONNEY  
51-444  
24 cm



COLLIN  
51-445  
28.5 cm





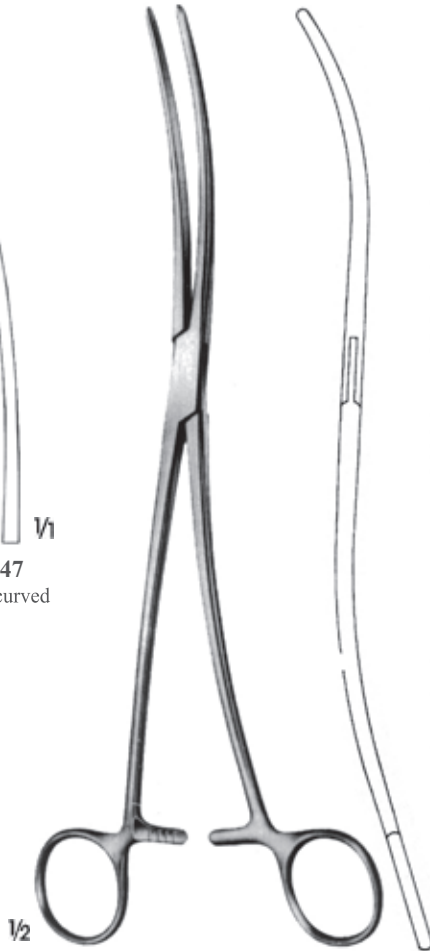
PELKMANN  
26 cm



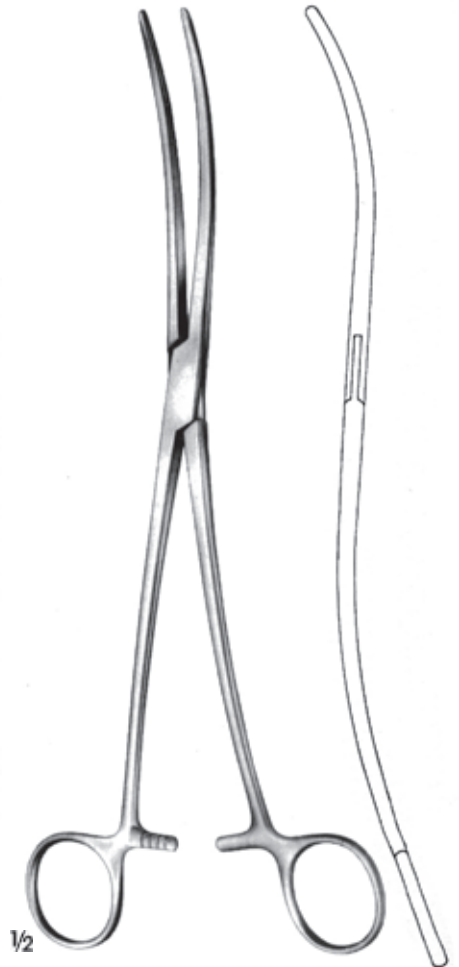
51-446  
düz/straight



51-447  
eğri/curved



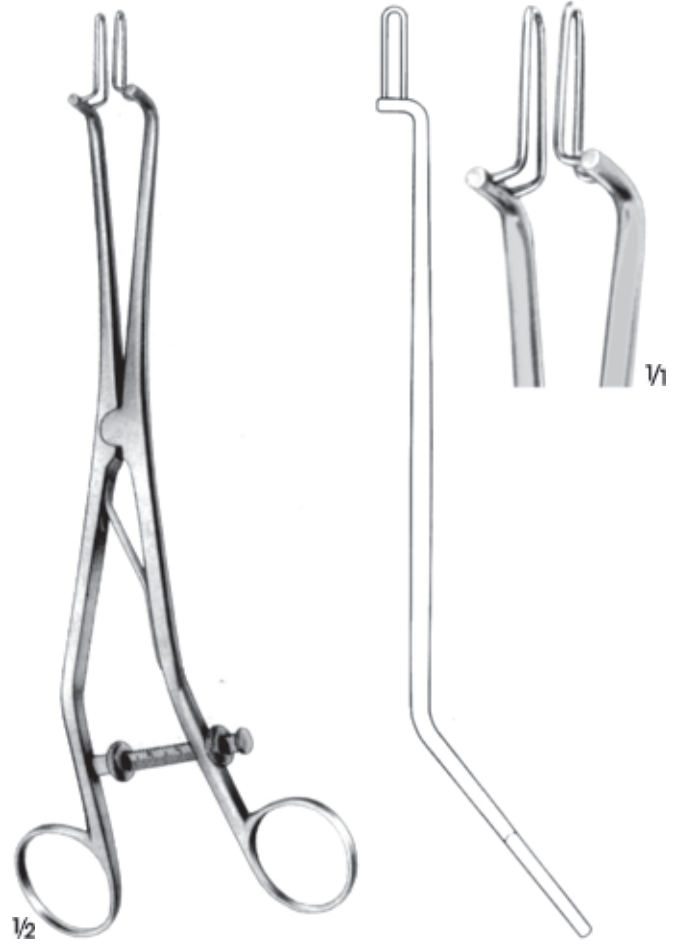
BOZEMANN  
51-448  
25 cm



BOZEMANN  
51-449  
Ağız oluklu pens  
Jaws with longitudinal  
groove  
25.5 cm



KOGAN  
**51-450**  
Kilitsiz/Without ratchet  
24 cm



KOGAN  
**51-451**  
Ölçülü sabitleyici ayar vidası  
With scale-ratchet and fixing screw  
24 cm



BREISKY  
**51-452** 100 x 20 mm  
**51-453** 100 x 25 mm  
**51-454** 100 x 30 mm  
**51-455** 100 x 35 mm  
**51-456** 100 x 40 mm  
 Viyana Model  
 Vienna patterns  
 30 cm



BREISKY  
**51-457** 130 x 20 mm  
**51-458** 130 x 25 mm  
**51-459** 130 x 30 mm  
**51-460** 130 x 35 mm  
**51-461** 130 x 40 mm  
 Viyana Model  
 Vienna patterns  
 32 cm



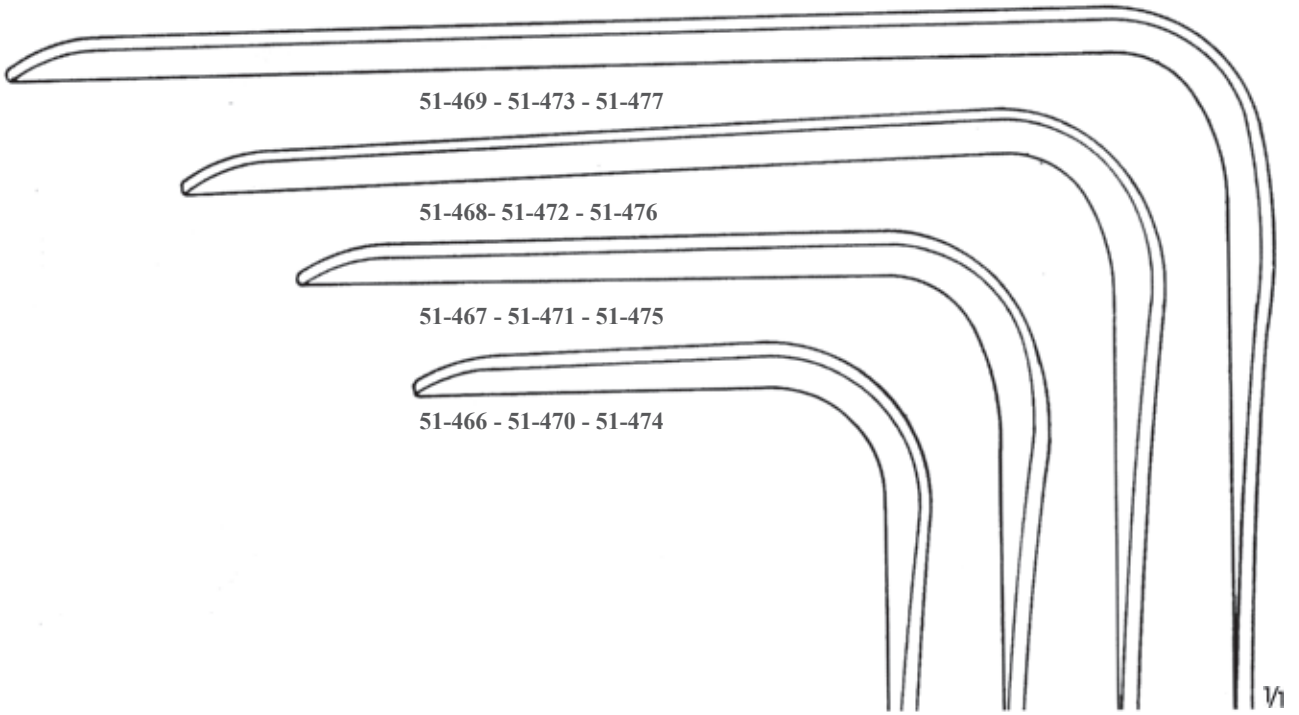
BREISKY  
**51-462** 160 x 40 mm  
**51-463** 180 x 40 mm  
 Viyana Model  
 Vienna patterns  
 35 cm



LANDAU  
**51-464** 100 x 28 mm  
**51-465** 110 x 38 mm  
 29 cm





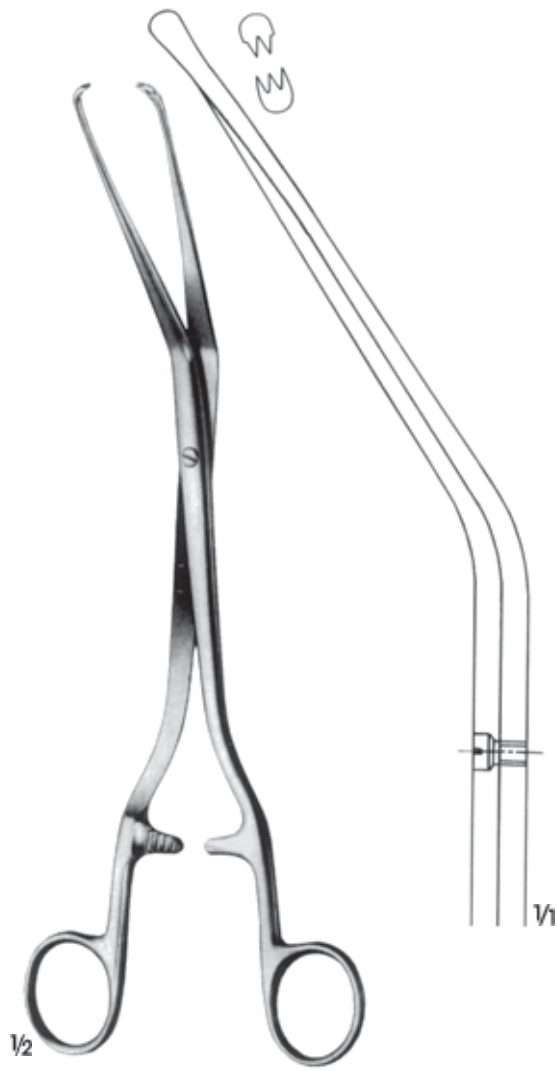


DOYEN  
24 cm

Ağız uzunlukları  
Length of blades

Ağız genişlikleri  
Width of blades

	35 mm	45 mm	60 mm
60 mm	<b>51-466</b>	<b>51-470</b>	<b>51-474</b>
90 mm	<b>51-467</b>	<b>51-471</b>	<b>51-475</b>
120 mm	<b>51-468</b>	<b>51-472</b>	<b>51-476</b>
160 mm	<b>51-469</b>	<b>51-473</b>	<b>51-477</b>



HERFF  
51-478  
Zar delici pens  
Membrane puncturing forceps  
25.5 cm



BEACHAM  
51-479  
Amniyotom/Amniotome  
24 cm



51-480  
Poş Açıcı/Pouch opener  
44 cm





**1/2**  
TÜBINGER  
**51-481**  
95 x 20 mm  
26.5 cm

**1/2**  
**51-482**  
105 x 27 mm  
25 cm

**1/2**  
SIMON  
**51-483**  
115 x 22 mm  
27.5 cm

**1/2**  
SIMON  
**51-484**  
115 x 26 mm  
27.5 cm



WEISSBARTH  
**51-485** 80 x 28 mm  
**51-486** 85 x 42 mm  
21 cm

**51-487**  
Sökülebilir süzgeçli  
Removable strainer only

1/2



AUVARD  
**51-488**  
65 x 38-28 mm  
1.530 gr.  
Sökülebilir ağırlıklı  
Wiht detachable weight  
23 cm

1/2



AUVARD  
**51-489** 75 x 42-40 mm  
**51-490** 105 x 43-40 mm  
1.470 gr. sökülebilir ağırlıklı  
With detachable weight  
23 cm

1/2



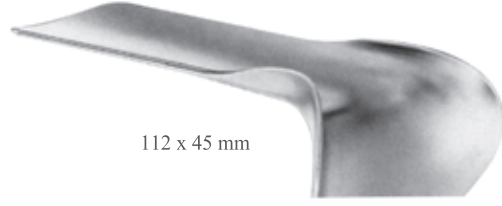
AUVARD  
**51-491**  
65 x 38-28 mm  
1.530 gr.  
Sabit ağırlık  
Fixed weight  
23 cm

1/2



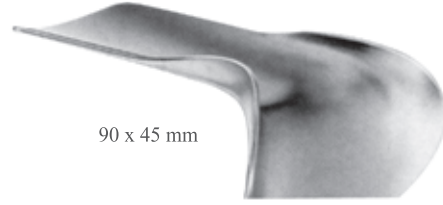
1/2

DOYEN  
T22-cm  
23.5 c



112 x 45 mm

51-494



90 x 45 mm

51-493



60 x 45 mm

51-492

1/2



60 x 30 mm

1/2

DOYEN  
51-495  
Yanal spekulum  
Lateral speculum  
23 cm

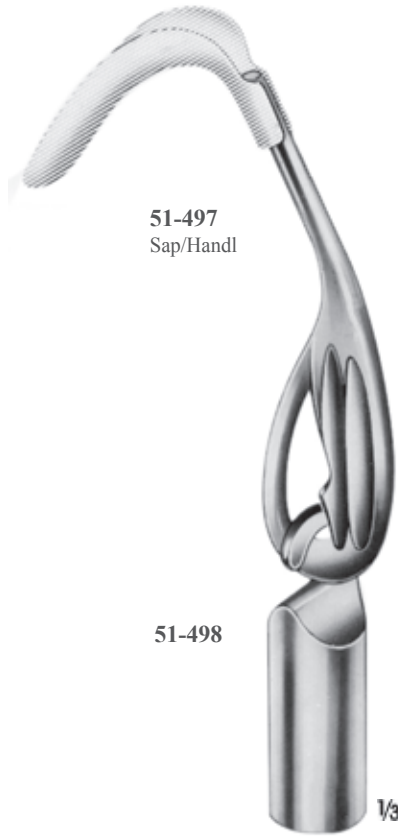


80 x 30 mm

1/2

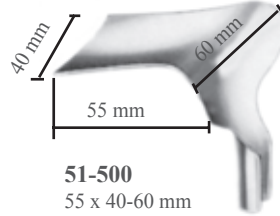
DOYEN  
51-496  
Yanal spekulum  
Lateral speculum  
25 cm



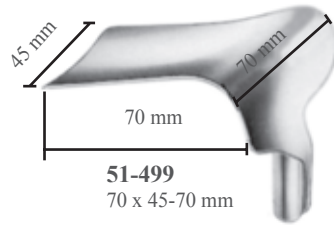


**51-497**  
Sap/Handl

**51-498**



**51-500**  
55 x 40-60 mm



**51-499**  
70 x 45-70 mm



**51-501**  
80 x 30 mm



**51-502**  
85 x 35 mm



**51-503**  
85 x 40 mm

SCHERBACK

1/3



**51-504**  
23 cm



**51-505**  
22 cm

BOZEMANN



**51-506**  
65 x 30 mm



**51-510**  
80 x 30 mm



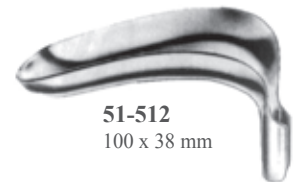
**51-507**  
75 x 35 mm



**51-511**  
85 x 33 mm



**51-508**  
85 x 35 mm



**51-512**  
100 x 38 mm



**51-509**  
95 x 35 mm



**51-513**  
110 x 42 mm



**WRIGLEY**  
**51-514**  
Sezeryan ameliyatı için  
For caesarean section  
25 cm



**SELHEIM**  
**51-515**  
Obstetrik levye  
Obstetric lever  
30 cm



**KIELLAND**  
**51-516**  
42 cm



**PIPER**  
**51-517**  
44.5 cm



**SIMPSON  
51-518**  
Sezeryan ameliyatı için  
For caesarean section  
23.5 cm



**SIMPSON-BRAUN  
51-519**  
30.5 cm



**SIMPSON-BRAUN  
51-520**  
35 cm



**NAGELE  
51-521**  
35.5 cm







1/2  
HEANEY  
51-522  
89 x 29 mm  
17 cm



1/2  
EASTMAN  
51-523  
89 x 38 mm  
17.5 cm



1/2  
BRAUN  
51-524  
60 x 10 mm  
18 cm



1/2  
BRAUN  
51-525  
56 x 13 mm  
18 cm



1/2  
LONDON  
51-526  
89 x 25 mm  
19.5 cm



1/2  
MATHIEU  
51-527  
Üst bleyd/Upper blade  
95 x 17 - 26 mm  
(İç bleyd/Inner blade K 843.01)  
21 cm



1/2  
MATHIEU  
51-528  
İç bleyd/Inner blade  
95 x 17 - 30 mm  
21 cm

KRISTELLER  
Alt bleyd/Lower blade



**51-529**  
70 x 15 mm  
17.5 cm



**51-530**  
70 x 27 mm  
18 cm



**51-531**  
75 x 30 mm  
18 cm



**51-532**  
90 x 36 mm  
18.5 cm



KRISTELLER  
Üst bleyd/Upper  
blades



**51-533**  
75 x 10 mm  
17.5 cm



**51-534**  
75 x 23 mm  
18 cm



**51-535**  
80 x 25 mm  
18 cm



**51-536**  
100 x 32 mm  
18.5 cm





KRISTELLER

- 51-537** 70 x 27 mm
- 51-538** 75 x 30 mm
- 51-539** 90 x 36 mm
- 51-540** 17.5 cm

1/2



KRISTELLER

- 51-541** 110 x 18 mm
- 51-542** 110 x 20 mm
- 51-543** 110 x 27 mm
- 51-544** 110 x 30 mm
- 51-545** 110 x 36 mm
- 22 cm

1/2



SEIDL

- 51-546** 80 x 8 mm
- 51-547** 80 x 10 mm
- 51-548** 90 x 14 mm
- Çocuklar ve bebekler için  
For children and infants
- 17 cm

1/2



KRISTELLER

- 51-549** 70 x 15 mm
- Çocuklar için  
For children
- 17 cm

1/2

KRISTELLER  
Üst bleyd/Upper  
blades 20.5 cm



51-550  
80 x 28 mm



51-551  
85 x 35 mm



51-552  
85 x 40 mm



JACKSON  
Alt bleyd/Lower  
blades



51-553  
76 x 38 mm



51-554  
89 x 38 mm



51-555  
110 x 38 mm





KRISTELLER  
 Üst bleyd/Upper  
 blades



KRISTELLER  
 Alt bleyd/Lower  
 blades

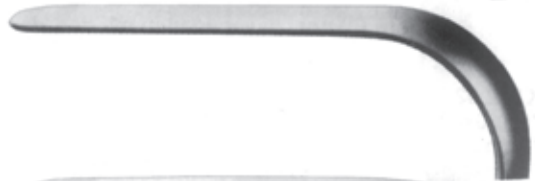
**51-556**  
 115 x 14 mm  
 21.5 cm



**51-557**  
 115 x 23 mm  
 21.5 cm



**51-558**  
 115 x 16 mm  
 22 cm



**51-559**  
 115 x 26 mm  
 22 cm



**51-560**  
 120 x 30 mm  
 22.5 cm



1/2

**51-561**  
 110 x 18 mm  
 21.5 cm



**51-562**  
 110 x 27 mm  
 21.5 cm



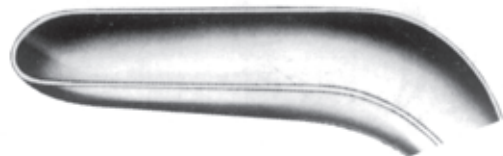
**51-563**  
 110 x 20 mm  
 22 cm



**51-564**  
 110 x 30 mm  
 22 cm



**51-565**  
 110 x 36 mm  
 22.5 cm



1/2

**51-566**  
110 x 20 mm



**51-567**  
110 x 30 mm



**51-568**  
110 x 36 mm



**51-569**  
115 x 18 mm



**51-570**  
115 x 26 mm



**51-571**  
115 x 32 mm



KRISTELLER  
Viyana model set Vienna  
patterns sets 21.5 cm

1/2



KRISTELLER  
Üst bleyd/Upper blade  
22 cm

1/2





SIMS

**51-574** 70 x 26 / 75 x 30 mm  
12.5 cm

**51-575** 75 x 30 / 80 x 35 mm  
15 cm

**51-576** 80 x 36 / 90 x 40 mm  
17.5 cm



1/2



KALLMORGEN  
**51-577** Set/Set  
75 x 39 mm  
17 cm

KALLMORGEN  
**51-578** Set/Set  
95 x 39 mm  
20 cm

1/2

1/2

**52**

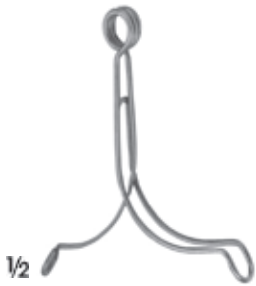




WINKELMANN

- 52-100** Ø 10 mm
- 52-101** Ø 12 mm
- 52-102** Ø 14 mm
- 52-103** Ø 16 mm
- 52-104** Ø 18 mm
- 52-105** Ø 20 mm
- 52-106** Ø 22 mm

Sünnet klempleri  
Circumcision clamps



1/2

STOCKMANN  
**52-107**  
Penis klemp  
Penis clamp  
7 cm



1/2

STRAUSS  
**52-108**  
Penis klemp  
Penis clamp  
13 cm



1/2

GUYON  
Üretral dilatasyon bujileri  
Urethral dilating bougies  
25.5 cm

- |        |                  |
|--------|------------------|
| 52-109 | Ben 24/ Charr.12 |
| 52-110 | Ben.25           |
| 52-111 | Ben 26/ Charr.13 |
| 52-112 | Ben.27           |
| 52-113 | Ben 28/ Charr.14 |
| 52-114 | Ben.29           |
| 52-115 | Ben 30/ Charr.15 |
| 52-116 | Ben.31           |
| 52-117 | Ben 32/ Charr.16 |
| 52-118 | Ben.33           |
| 52-119 | Ben 34/ Charr.17 |
| 52-120 | Ben.35           |
| 52-121 | Ben 36/ Charr.18 |
| 52-122 | Ben.37           |
| 52-123 | Ben 38/ Charr.19 |
| 52-124 | Ben.39           |
| 52-125 | Ben 40/ Charr.20 |
| 52-126 | Ben.41           |
| 52-127 | Ben 42/ Charr.21 |
| 52-128 | Ben.43           |
| 52-129 | Ben 44/ Charr.22 |
| 52-130 | Ben.45           |
| 52-131 | Ben 46/ Charr.23 |
| 52-132 | Ben.47           |
| 52-133 | Ben 48/ Charr.24 |
| 52-134 | Ben.49           |
| 52-135 | Ben 50/ Charr.25 |
| 52-136 | Ben.51           |
| 52-137 | Ben 52/ Charr.26 |
| 52-138 | Ben.53           |
| 52-139 | Ben 54/ Charr.27 |
| 52-140 | Ben.55           |
| 52-141 | Ben 56/ Charr.28 |
| 52-142 | Ben.57           |
| 52-143 | Ben 58/ Charr.29 |
| 52-144 | Ben.59           |
| 52-145 | Ben 60/ Charr.30 |



1/2

TURNER WARWICK  
52-146  
Gerici buji  
Retrograde bougie  
18 cm





1/3

**GUYON**  
**52-147**  
Katater klavuz  
Catheter guide  
36.5 cm



1/3

**52-148**  
Katater için uygulayıcı  
Introducer for catheters  
46 cm



1/2

**DITTEL**  
Üretral dilatasyon  
bujileri Urethral dilating  
bougies 34.5 cm

Charr.

52-149	8
52-150	9
52-151	10
52-152	11
52-153	12
52-154	13
52-155	14
52-156	15
52-157	16
52-158	17
52-159	18
52-160	19
52-161	20
52-162	21
52-163	22
52-164	23
52-165	24
52-166	25
52-167	26
52-168	27
52-169	28
52-170	29
52-171	30



BARRE  
**52-172**  
No.3 XL  
Sol el için  
For left hand  
25 cm



BARRE  
**52-173 - 52-174**  
No.3 XL  
Sol el için  
For left hand  
25 cm



**52-173**  
12°



**52-174**  
25°



**1/2**  
YOUNG-HRYNTSCHAK  
**52-175**  
24 cm



**52-176**

**1/1**



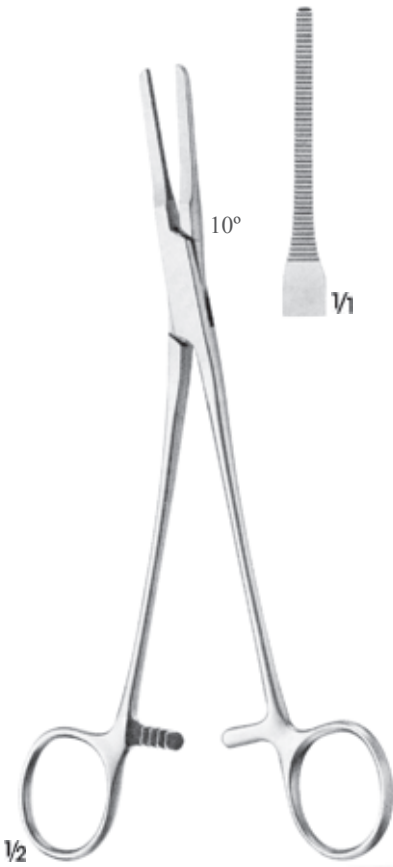
**52-177**

**1/1**



**52-178**

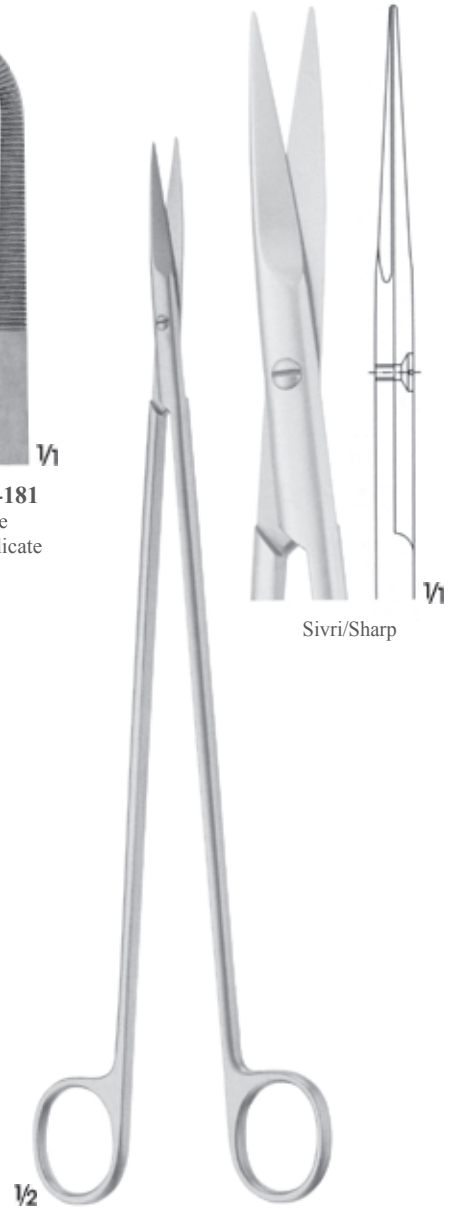
**1/1**



**52-179**  
Venöz plexus klemp  
Venous plexus clamp  
21 cm



BARRE'Dissecting  
forceps  
Diseksiyon pensleri  
28 cm



BARRE  
**52-182**  
Diseksiyon makası  
Dissecting scissors  
28 cm





	Charr.
<b>52-183</b>	3
<b>52-184</b>	4
<b>52-185</b>	5
<b>52-186</b>	6

Uterin sonda Uterine  
probe  
33 cm



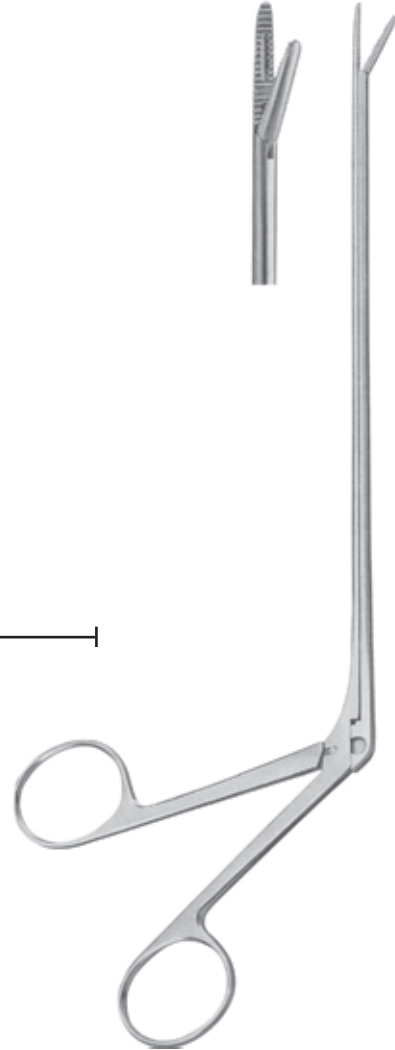
ASCH  
**52-187**  
Uterin kaşık küret, küt  
Uterine secretion scoop, blunt  
20 cm

Bükülebilir  
Malleable



19 cm

1/1



MATHIEU  
**52-188**  
Yabancı cisim pensi  
Foreign body forceps  
19 cm

1/2



Atromatik  
Atraumatic



**52-190**  
24 cm



**52-191**  
23 cm



**52-192**  
23 cm



GUYON

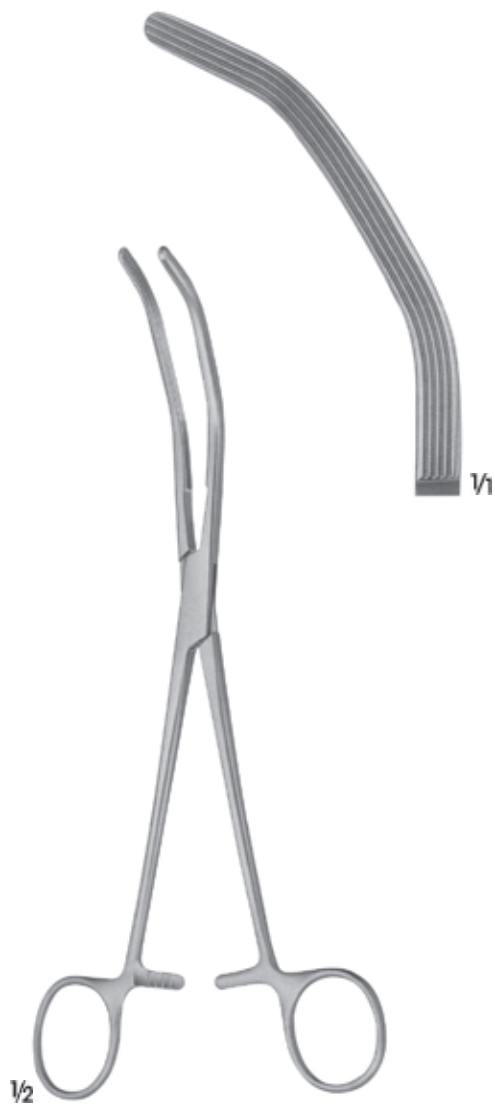


**52-192**  
23 cm



GUYON  
**52-193**  
23 cm





HERRICK  
52-194  
22.5 cm



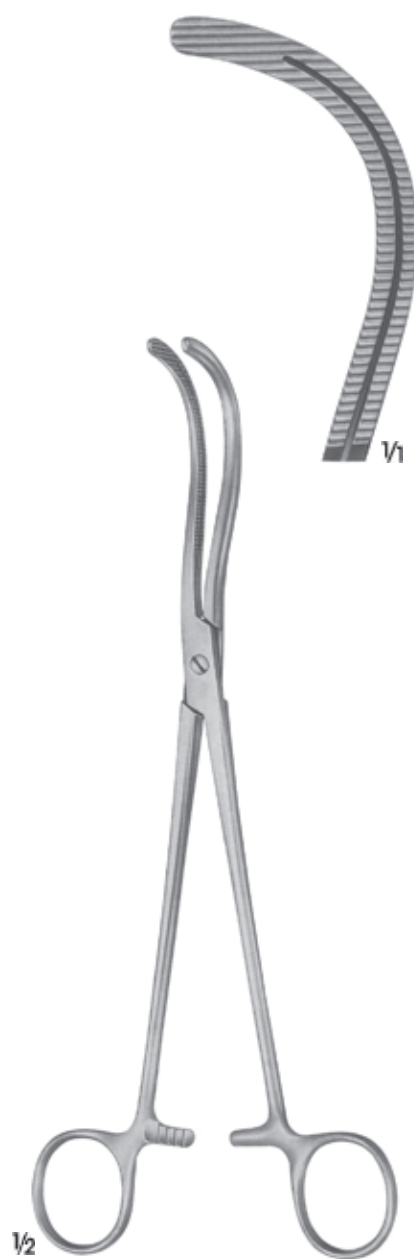
WERTHEIM  
52-195  
25.5 cm



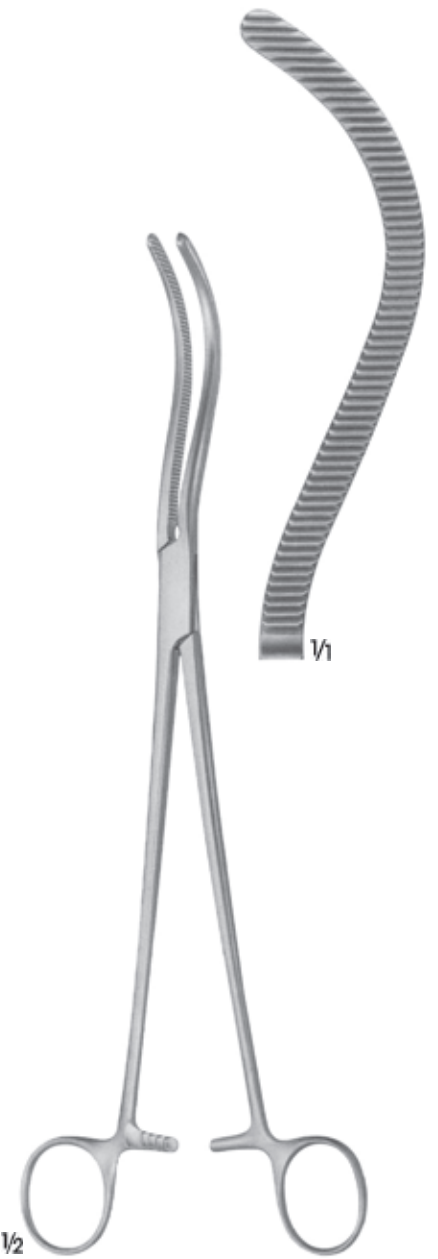




STILLE  
52-196  
22 cm



STILLE  
52-197  
24 cm



GUYON  
52-198  
26.5 cm



52-199  
19.5 cm



52-200  
22 cm



52-201  
23 cm



1/1



PEAN



1/2

GUYON  
52-202  
23.5 cm



52-203  
17 cm

52-204  
16 cm



52-205

52-206



HEIMING  
Çocuklar için/For children



RANDALL  
22.5 cm

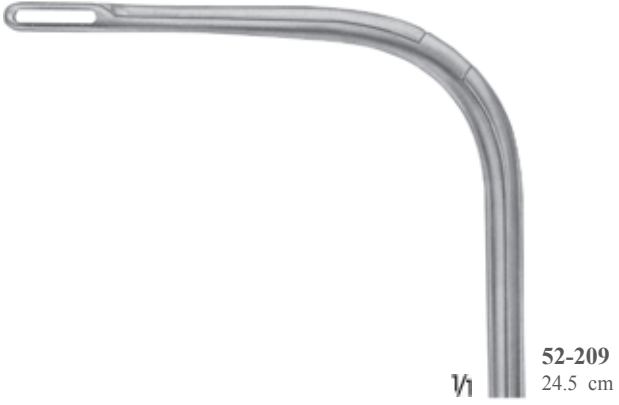


52-207



52-208





52-209  
24.5 cm  
1/1



52-211  
1/1



52-210  
23 cm  
1/1



52-212  
1/1



RANDALL  
Çok hassas model Extremely  
delicate patterns



1/2  
RANDALL  
19 cm



WERTHEIM - CULLEN  
52-213  
Açılı baskı klempi  
Angle- and pressure clamp  
21.5 cm



WERTHEIM  
52-214  
Açılı baskı klempi  
Angle- and pressure clamp  
25 cm





**1/2**  
YOUNG  
**52-215**  
21 cm



**1/2**  
YOUNG  
**52-216**  
21 cm



**1/2**  
**52-217**  
Prostat ekartör  
Prostate retractor  
36 cm



**1/2**  
**52-218**  
Üretral ekartör  
Urethral retractor  
39 cm

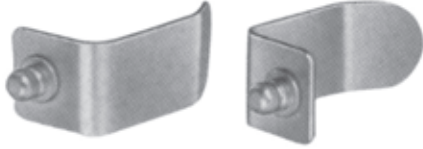


**DARTIGUES**  
**52-219**  
25.5 cm

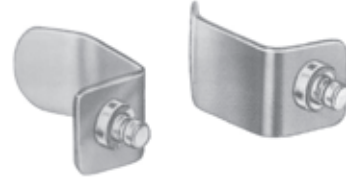


**COLLIN**  
**52-220**  
28.5 cm





**52-223**  
57 x 25 mm



**52-228**  
57 x 25 mm



**52-224**  
82 x 25 mm



**52-229**  
82 x 25 mm

**MILLIN**

- 52-221** Komple/Complete
- 52-222** Sadece ekartör/Retractor only
- 52-223** Bleyd 57 x 25 mm/Blades 57 x 25 mm
- 52-224** Bleyd 82 x 25 mm/Blades 82 x 25 mm
- 52-225** Orta bleyd 105 x 45 mm/Center blade 105 x 45 mm

**MILLIN**

- 52-226** Komple/Complete  
Işık taşıyıcılı/With light carrier
- 52-227** Sadece ekartör/Retractor only
- 52-228** Bleyd 57 x 25 mm/Blades 57 x 25 mm
- 52-229** Bleyd 82 x 25 mm/Blades 82 x 25 mm
- 52-230** Orta bleyd 105 x 45 mm/Center blade 105 x 45 mm





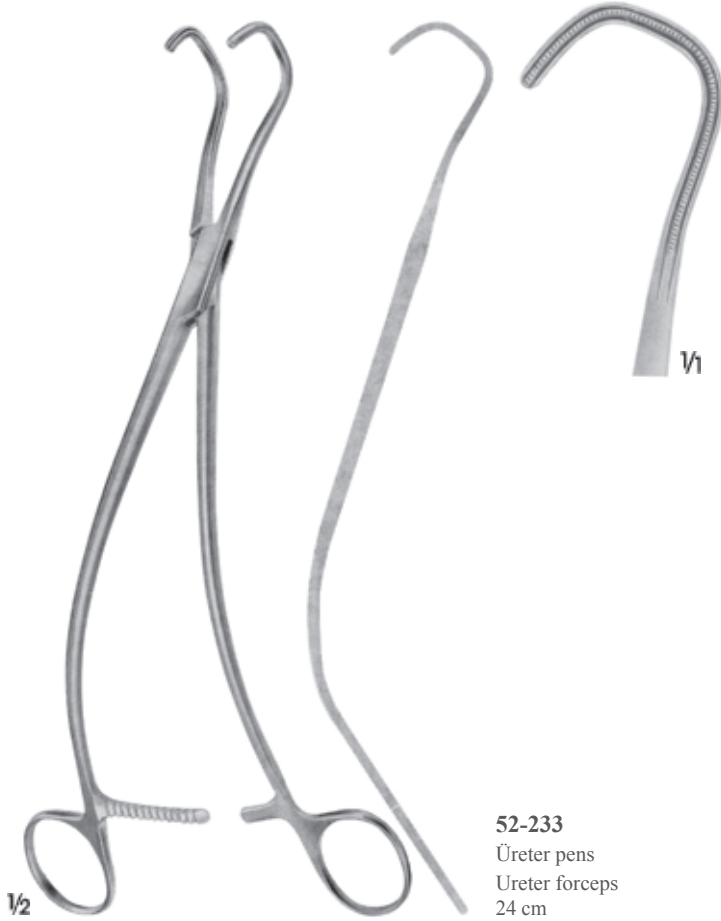


**52-231**  
Ø 4.8 mm  
Glans ve sünnet derisi  
tutma pensi  
Forceps for grasping the glans  
and the foreskin  
12.5 cm



**52-232**  
Testis sabitleme klemp  
Fixation clamp for the  
spermatic cord  
14.5 cm

Atromatik  
Atraumatic



**52-233**  
Üreter pens  
Ureter forceps  
24 cm



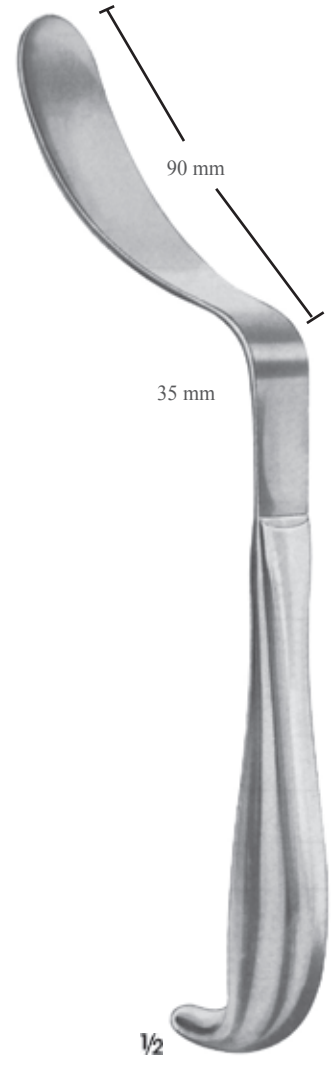
**C**  
Testis bağlayıcı huk  
Hook for the spermatic cord  
16.5 cm



**MILLIN**  
**52-235**  
Mesane ayırıcı  
Bladder neck spreader  
28.5 cm



**KOCHER**  
**52-236**  
Mesane ekartör  
Bladder retractor  
26 cm

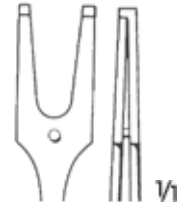


**LEGUEU**  
**52-237**  
Mesane spatula  
Bladder spatula  
26 cm

Atromatik  
Atraumatic



Atromatik  
Atraumatic



**MILLIN  
52-238**  
Lobe yakalama pensi  
Lobe grasping forcecp  
23.5 cm



**MILLIN  
52-239**  
Lobe tutma pensi  
Lobe grasping forcecp  
24.5 cm

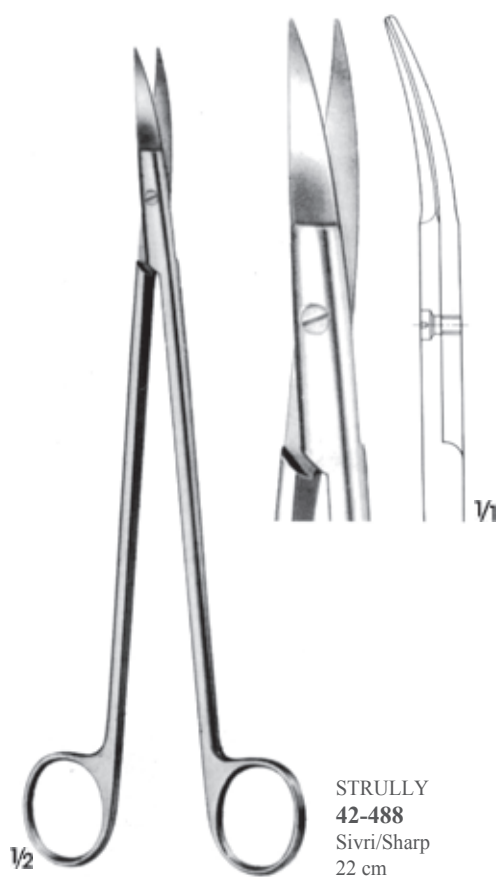


**MILLIN  
52-240**  
Bağ tutucu pens  
Ligature holding forcecp  
24.5 cm

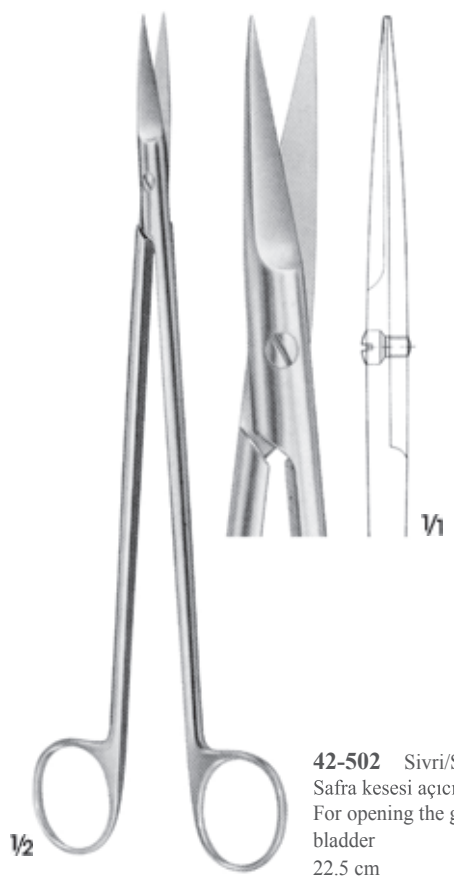




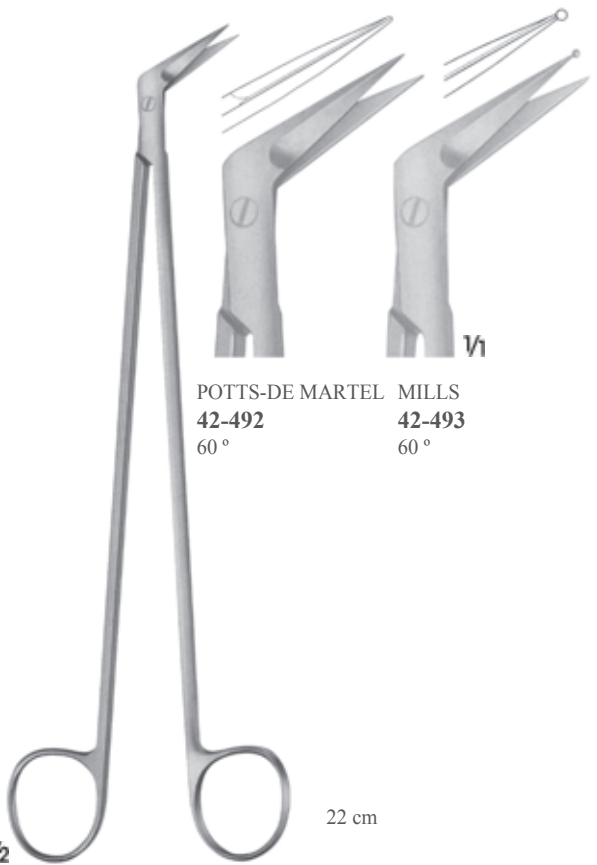
**53**



STRULLY  
42-488  
Sivri/Sharp  
22 cm



42-502 Sivri/Sharp  
Safra kesesi açıcı  
For opening the gall  
bladder  
22.5 cm



POTTS-DE MARTEL MILLS  
42-492 60°  
42-493 60°

22 cm



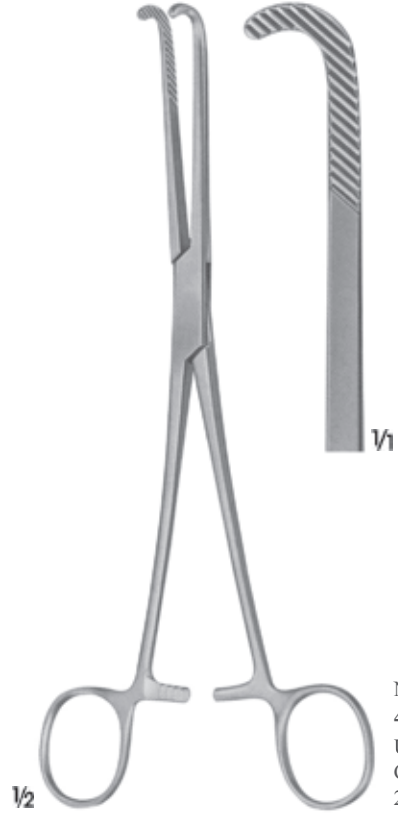
Hard Tips

60°

DE BAKEY  
42-344  
22 cm



**DESJARDINS  
45-403**  
Ur kanalı ve kistik pens  
Gall duct and cystic forceps  
22 cm



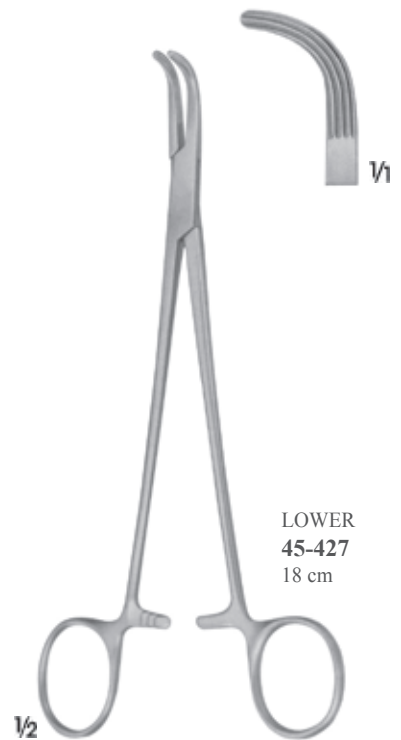
**NISSIN  
45-404**  
Ur kanalı ve kistik pens  
Gall duct and cystic forceps  
21.5 cm



**LAHEY(SWEET)  
45-432**  
20 cm

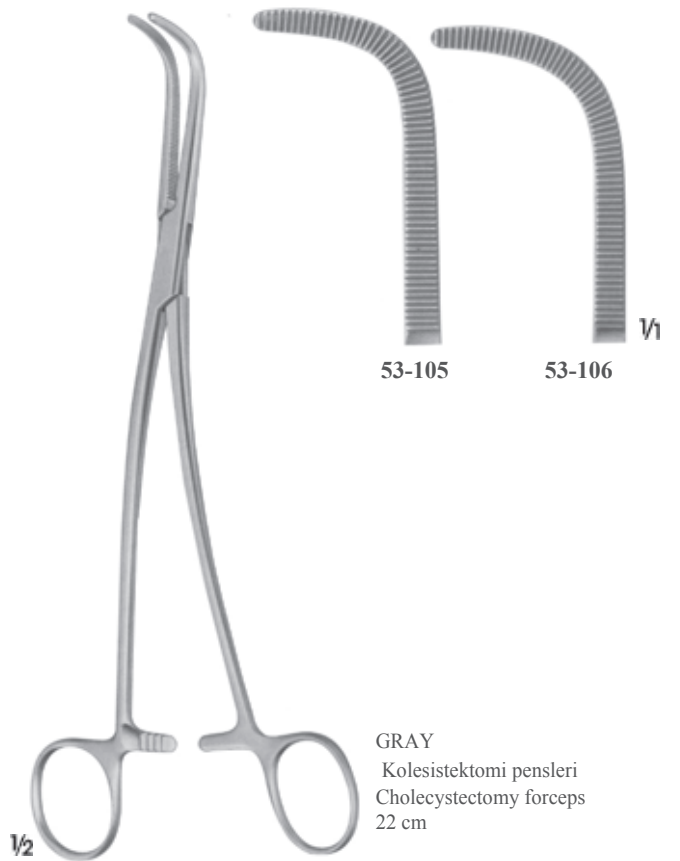
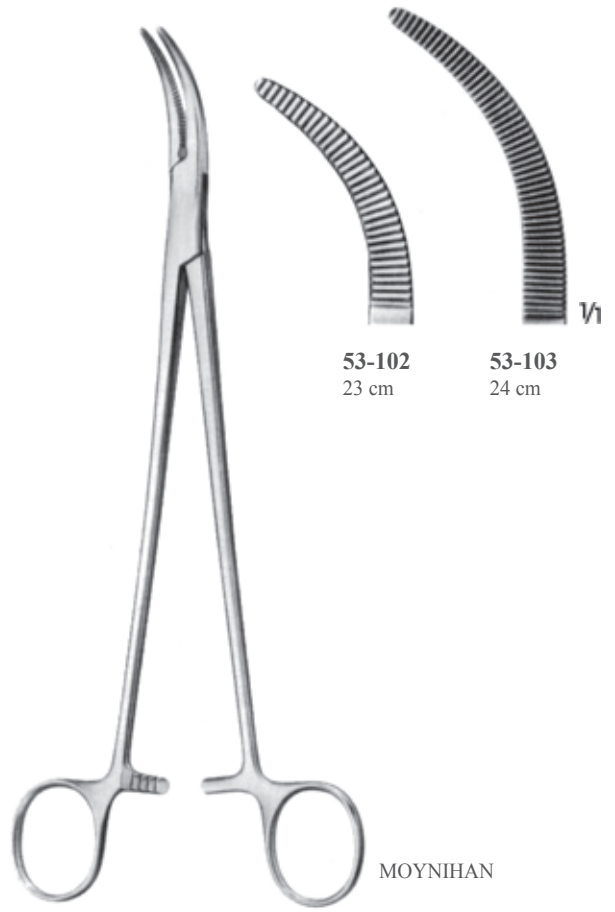
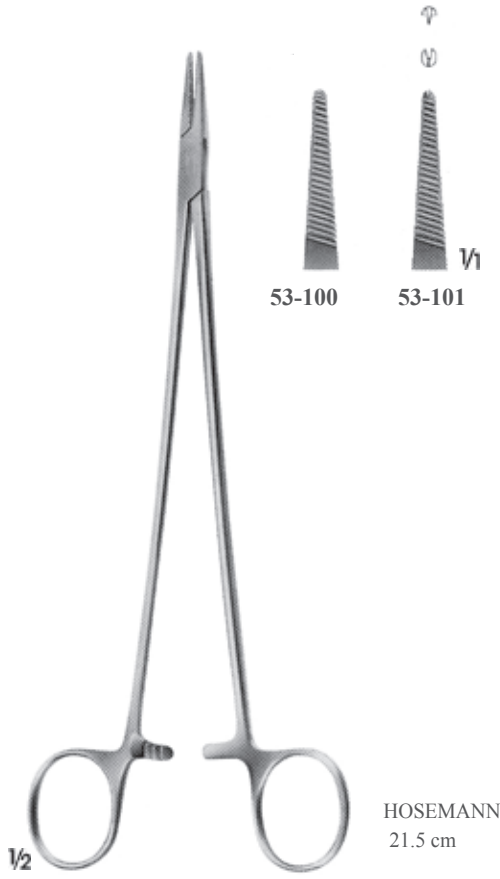


**LAHEY  
45-426**  
22.5 cm

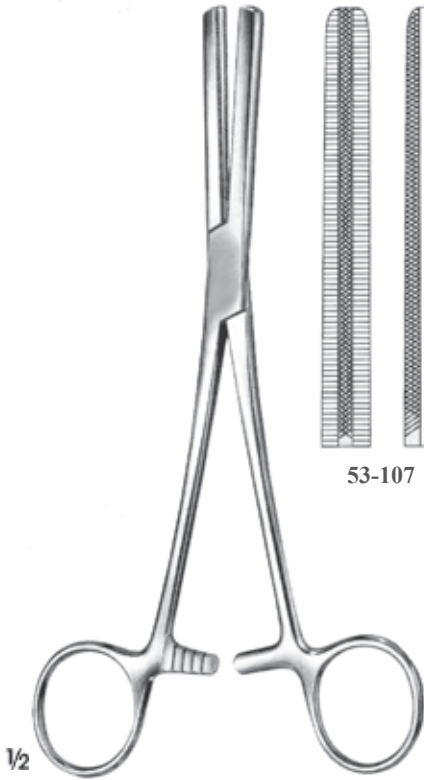


**LOWER  
45-427**  
18 cm

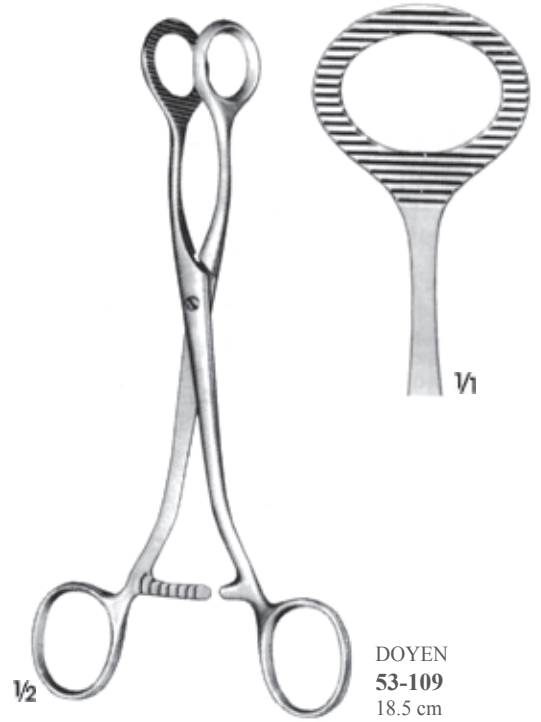




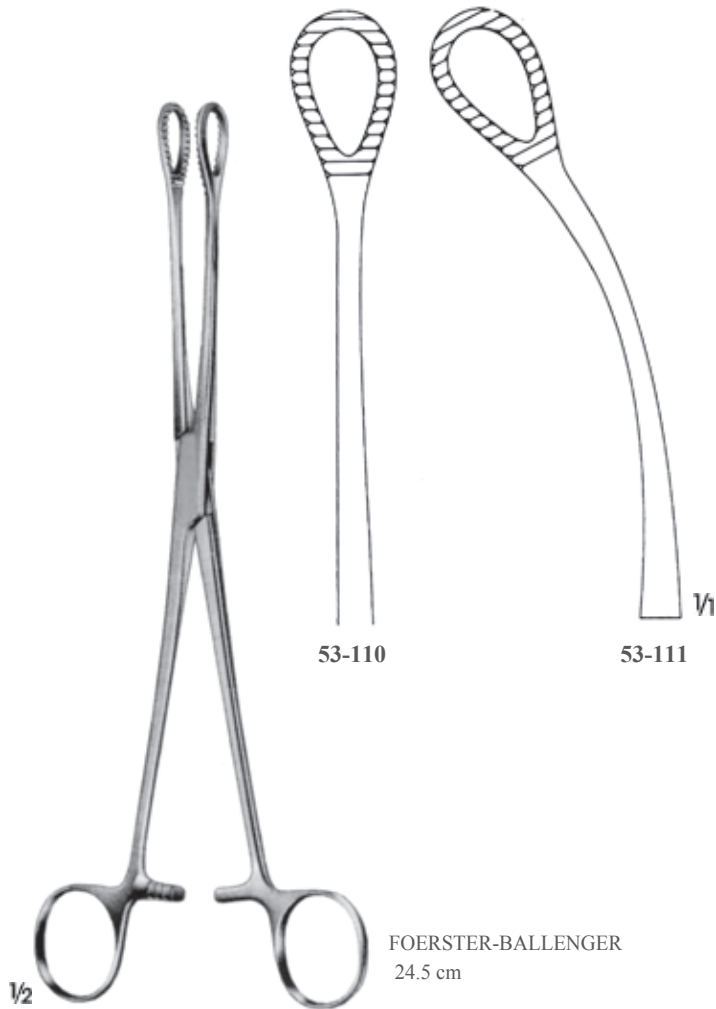




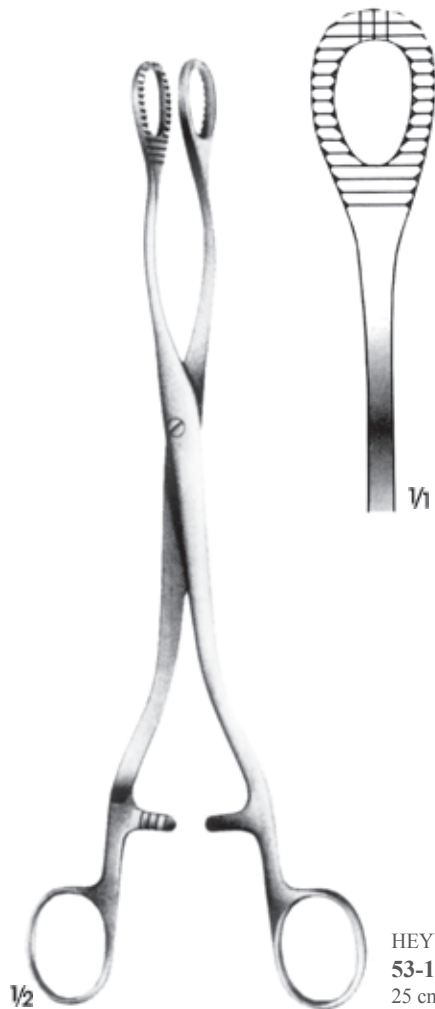
FERGUSSON  
53-107 - 53-108  
Basınç klempleri  
Pressure clamps  
20 cm



DOYEN  
53-109  
18.5 cm

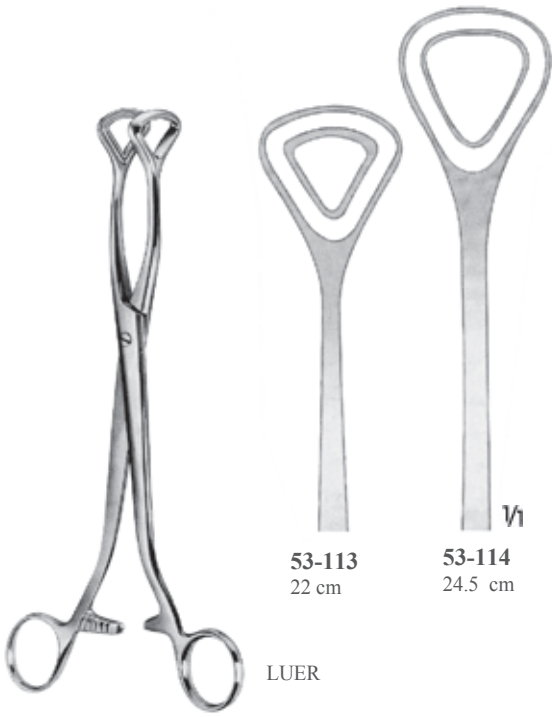


FOERSTER-BALLENGER  
24.5 cm



HEYWOOD-SMITH  
53-112  
25 cm

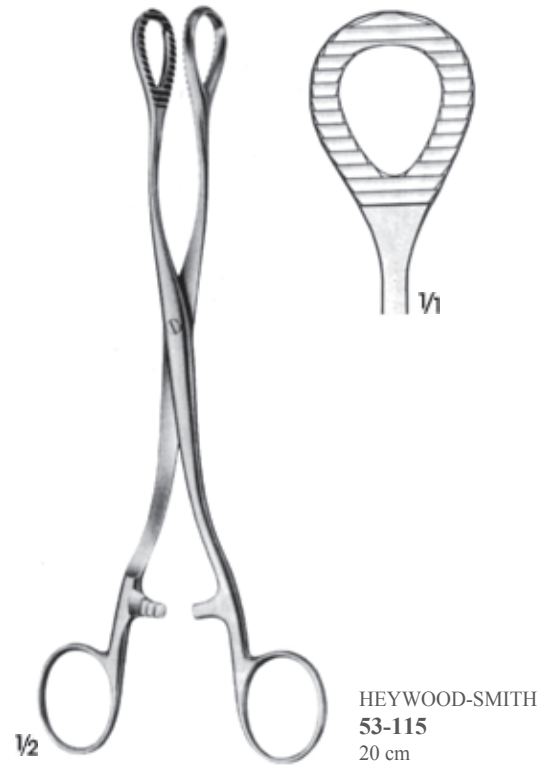




**53-113**  
22 cm

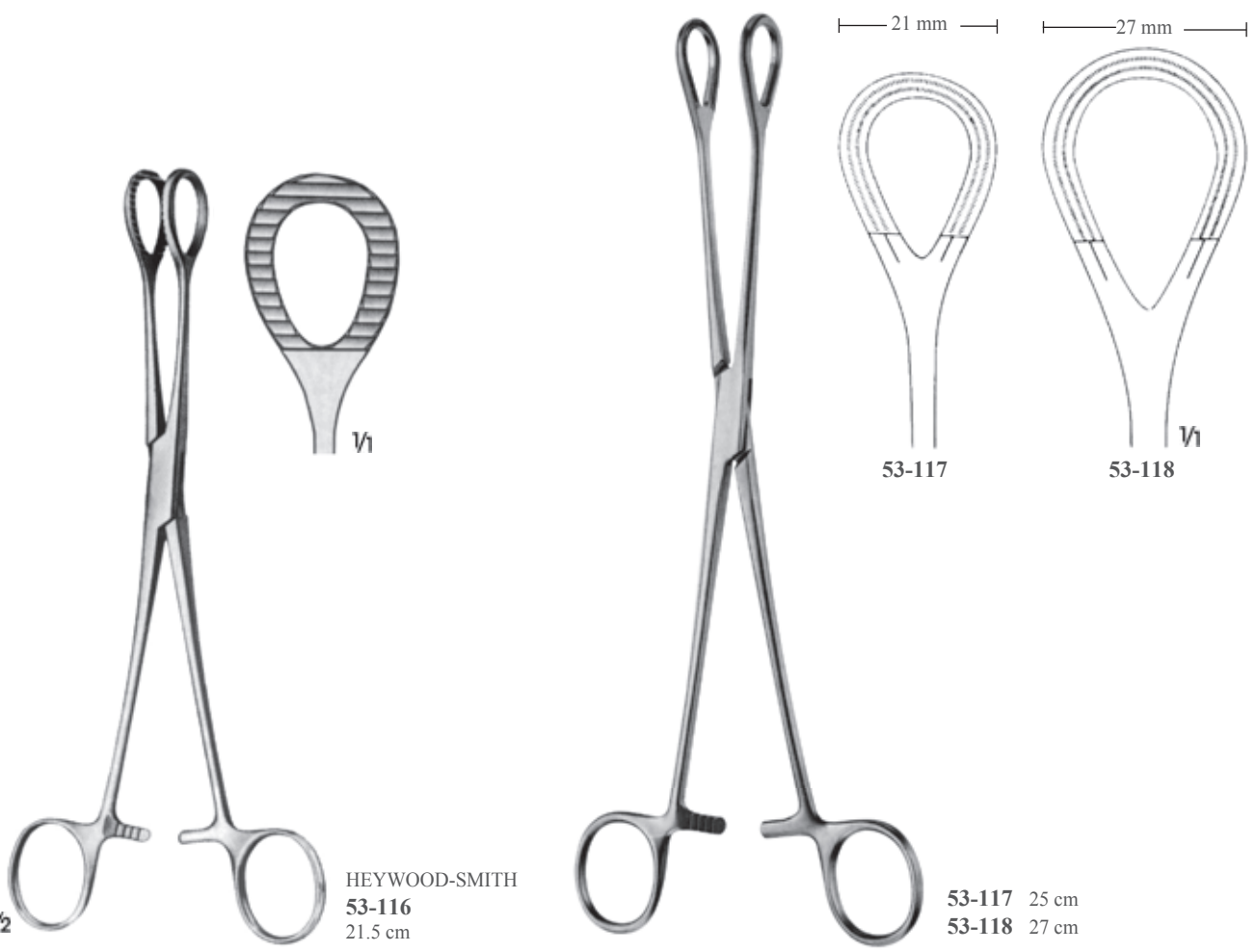
**53-114**  
24.5 cm

LUER



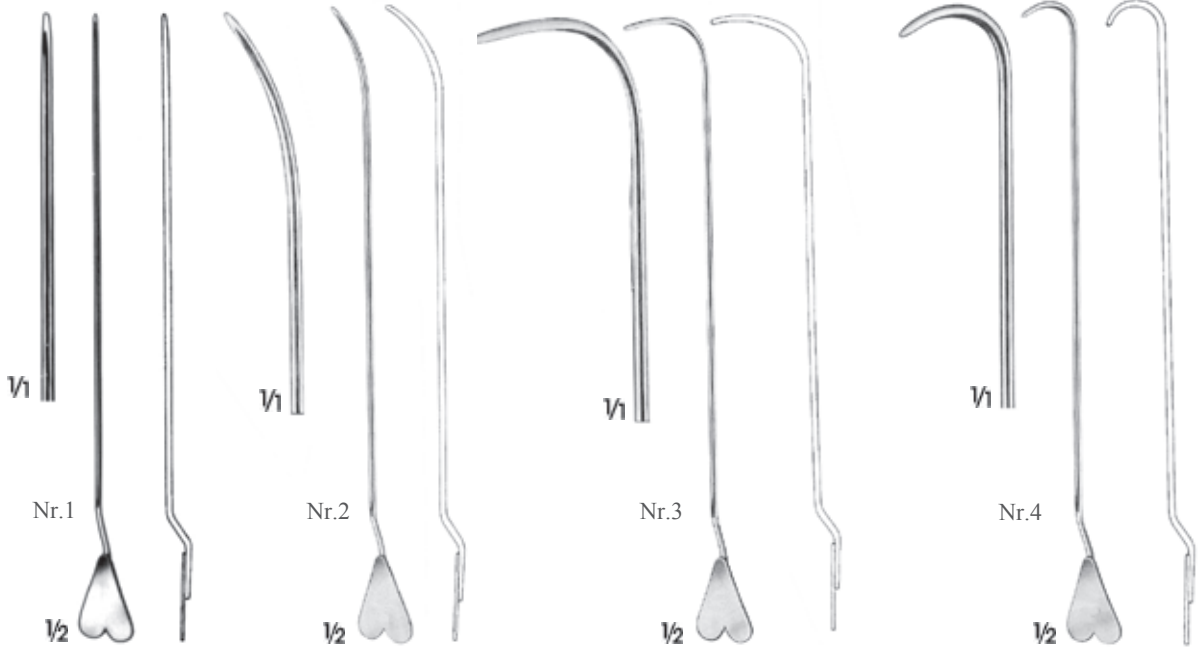
**HEYWOOD-SMITH**  
**53-115**  
20 cm

Atromatik  
Atraumatic



**HEYWOOD-SMITH**  
**53-116**  
21.5 cm

**53-117** 25 cm  
**53-118** 27 cm



**LOCKHART-MUMMERY**

Fistül sonda/Fistula probes

**53-119** Nr.1 Düz/Straight

**53-120** Nr.2 45° Eğri/Curved

**53-121** Nr.3 90° Eğri/Curved

**53-122** Nr.4 Geriye doğru eğri/Curved retrograde

16.5 cm

Ø 3.5 mm



**BIRODIE**  
**53-123**  
20 cm

Ø 3 mm



**53-124** Bükülebilir/  
Malleable 19 cm



**53-125**  
Çift delikli ve uçlu  
bükülebilir sonda  
Double ended probe,  
malleable, with hole  
19 cm



**53-126**  
Fistül sonda  
Fistula probe  
24 cm





**53-127**  
Ø 3.5 mm



HAJEK

Sulama kanülü  
Irrigating cannula  
16.5 cm



DESJARDINS

Safra kanalı sondaları, esneyebilir  
Gall duct probes, flexible  
28.5 cm

**53-128**  
Ø 3.8 mm



**53-129**  
Ø 4.3 mm



**53-130**  
Ø 6.8 mm



Ø 5 mm



MAYNIHAN  
**53-131**

Safra taşı sondası, kaşık ağızlı  
bükülebilir  
Gall stone probe and-scoop  
of tin, malleable  
36.5cm

Ø 3.5 mm



OCHSNER  
**53-132**

Safra kanalı sonda  
esneyebilir  
Gall duct probe, flexible  
40 cm

Ø 5 mm



MAYO  
**53-133**

Safra kanalı sonda  
bükülebilir  
Gall duct probe,  
malleable  
33 cm



**53-134**  
Katater kılavuz  
Catheter guide  
49 cm



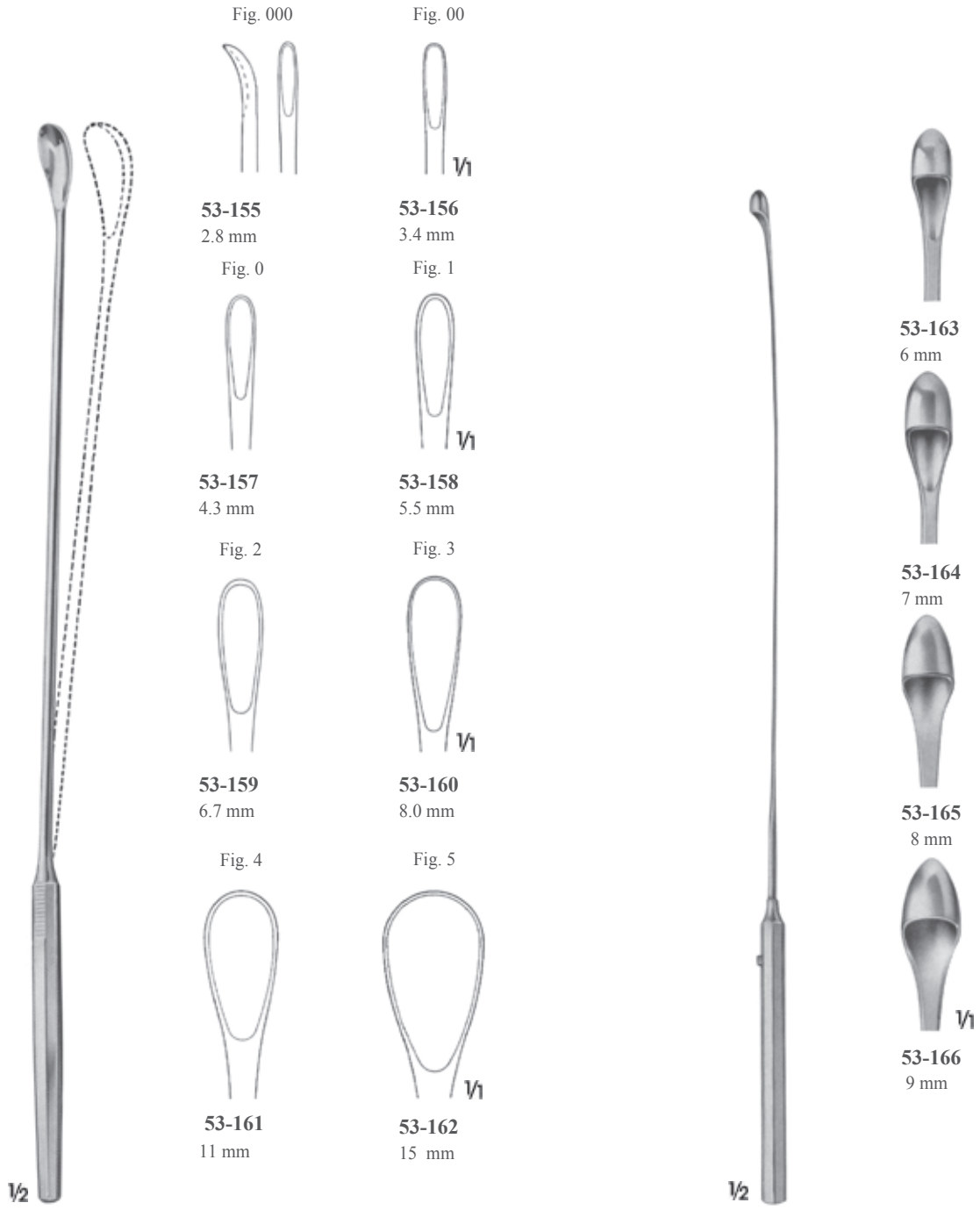
Erkekler için metal  
katater Male catheters,  
metal  
29 cm

	Charr.
<b>53-135</b>	8
<b>53-136</b>	10
<b>53-137</b>	12
<b>53-138</b>	14
<b>53-139</b>	16
<b>53-140</b>	18
<b>53-141</b>	20



Bayanlar için metal  
katater Female catheters,  
metal  
15.5 cm

	Charr.
<b>53-142</b>	6
<b>53-143</b>	7
<b>53-144</b>	8
<b>53-145</b>	9
<b>53-146</b>	10
<b>53-147</b>	11
<b>53-148</b>	12
<b>53-149</b>	13
<b>53-150</b>	14
<b>53-151</b>	15
<b>53-152</b>	16
<b>53-153</b>	18
<b>53-154</b>	20



LUER-KÖRTE  
Bükülebilir/Malleable  
31 cm

DESJARDINS  
Esnek şaft sonda ve yakalayıcı  
Probe and catch with flexible shaft  
30 cm



1/2

DITTEL

Metal buji ve dilatasyon sondaları  
Metal bougies and dilating sounds  
34.5 cm

- 53-167
- 53-168
- 53-169
- 53-170
- 53-171
- 53-172
- 53-173
- 53-174
- 53-175
- 53-176
- 53-177
- 53-178
- 53-179
- 53-180
- 53-181
- 53-182
- 53-183
- 53-184
- 53-185
- 53-186
- 53-187
- 53-188
- 53-189

Charr.  
(French)

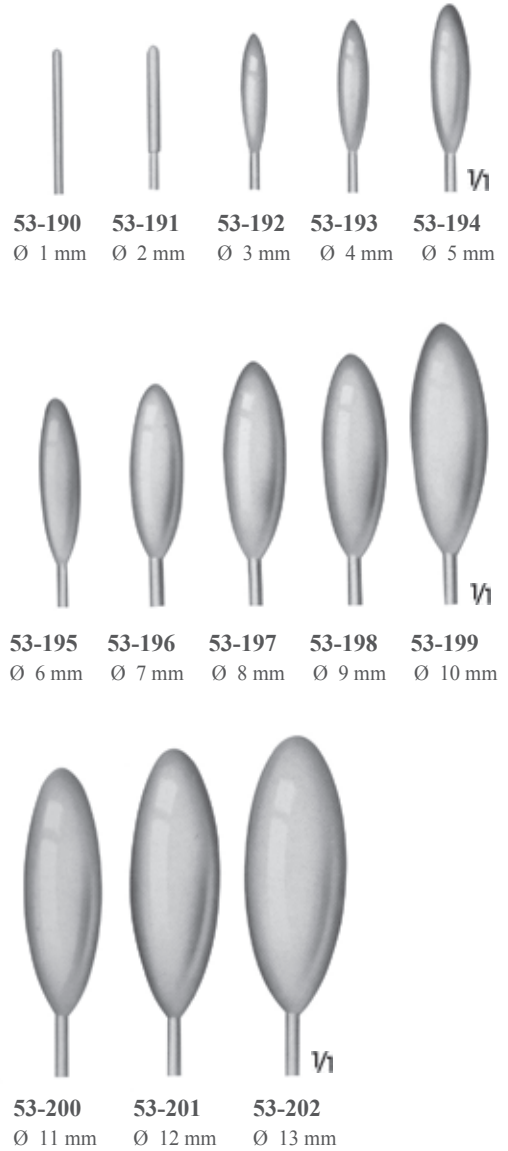
- 8
- 9
- 10
- 11
- 12
- 13
- 14
- 15
- 16
- 17
- 18
- 19
- 20
- 21
- 22
- 23
- 24
- 25
- 26
- 27
- 28
- 29
- 30

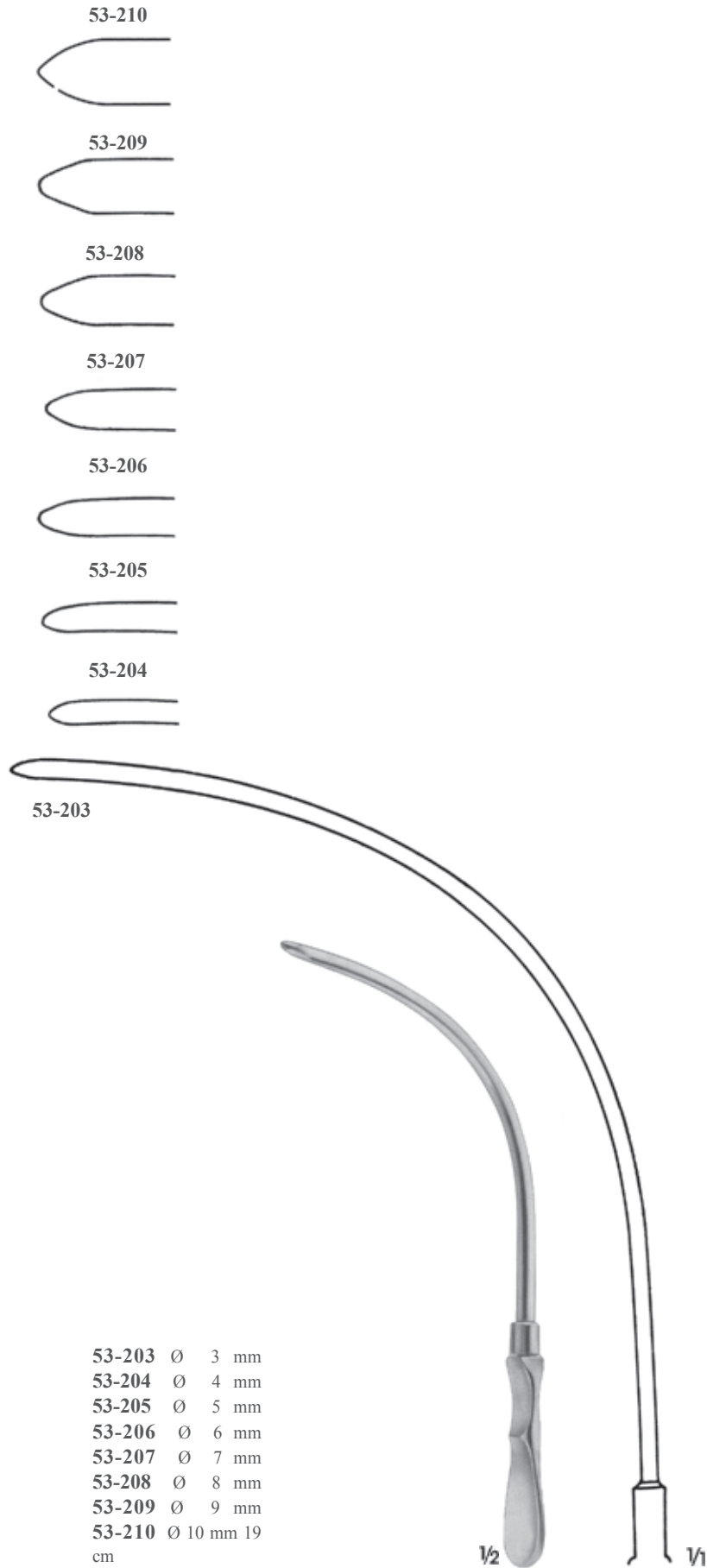


1/2

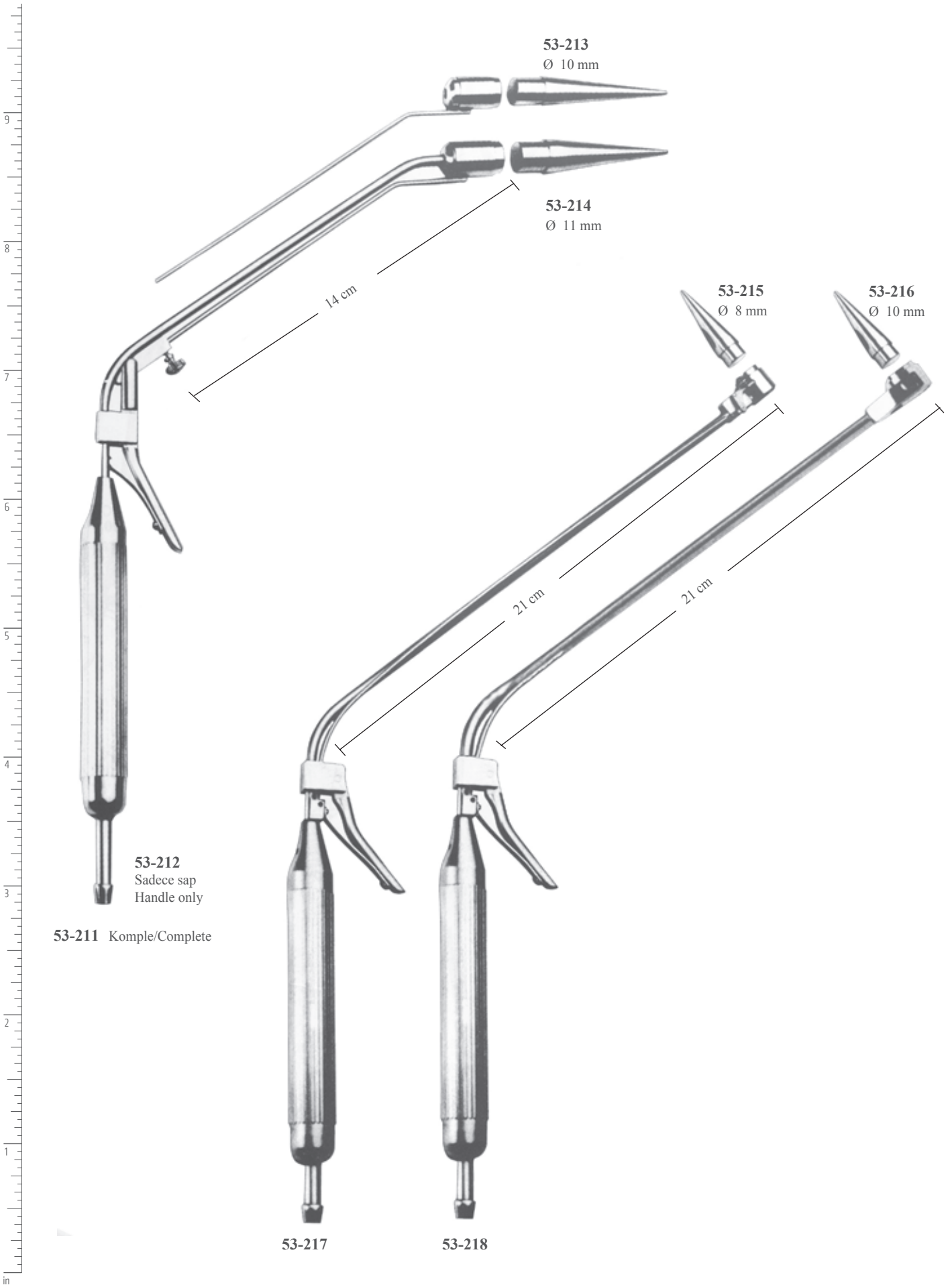
BAKES

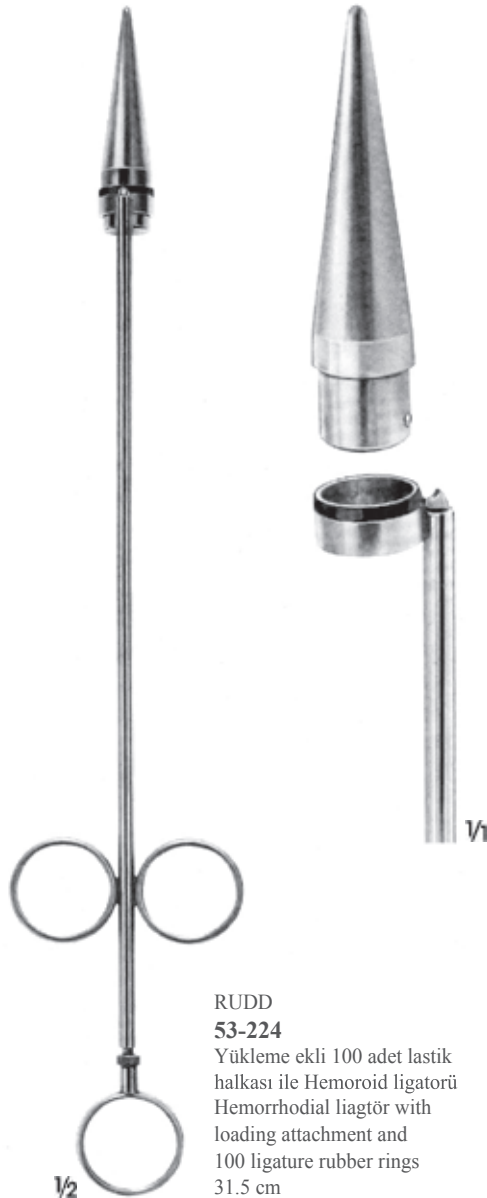
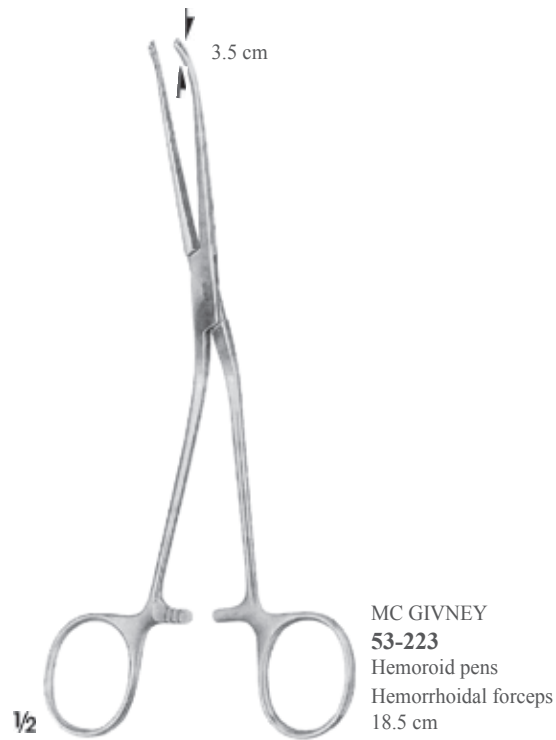
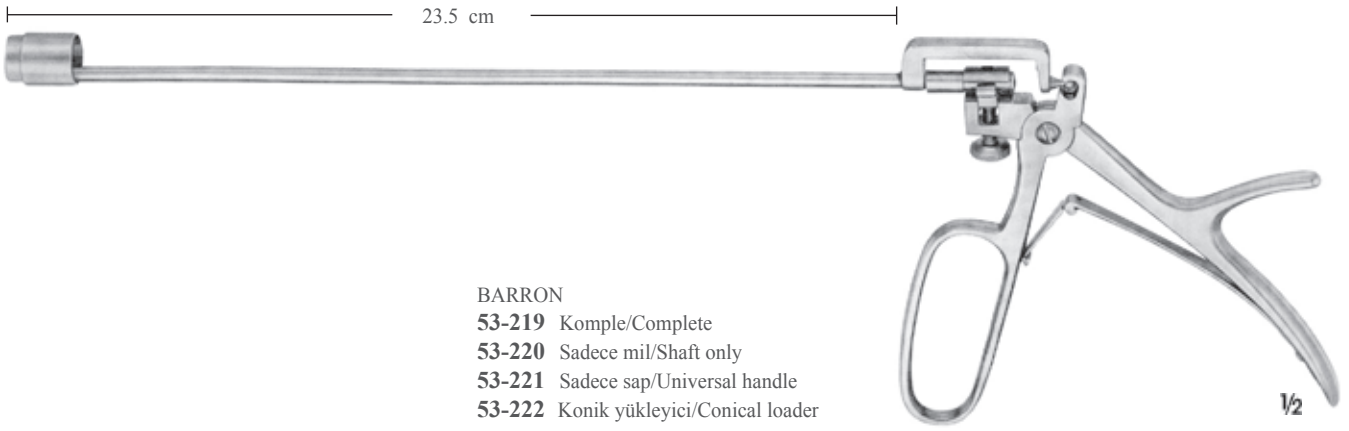
Safra kanalı için bükülebilir dilatörler  
Common bile duct dilators, malleable  
31 cm

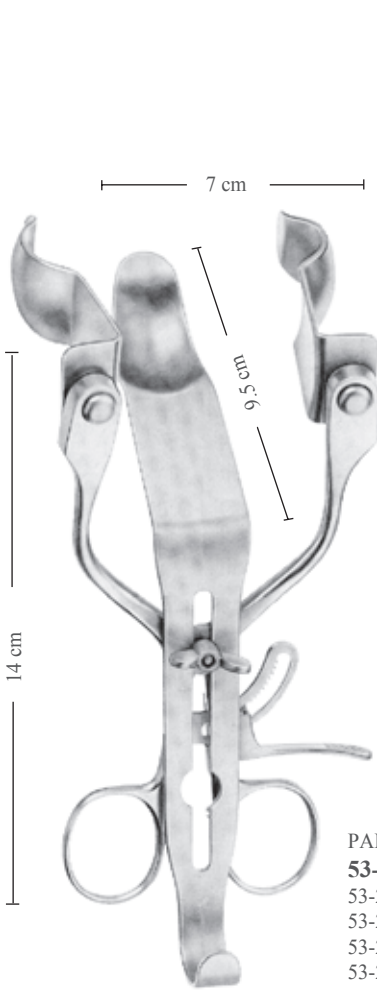






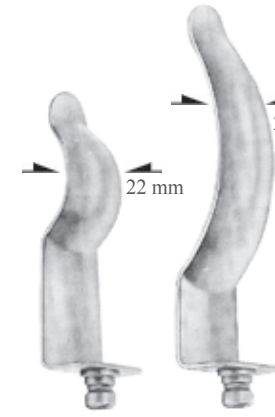






**PARKS**

- 53-226** Komple/Complete  
53-227 Sadece ekartör/Retractor only  
53-228 Orta bleyd/Center blade  
53-229 1 çift yan bleyd 70 mm/1 pair lateral blades 70  
53-230 1 çift yan bleyd 93 mm/1 pair lateral blades 93 mm



**53-229**  
Rektal bleyd  
Rectal blade  
70 mm



**53-230**  
Sfinker bleyd  
Sphincter blade  
93 mm



**53-231**  
Anostomoz bleyd  
Anostomosis blade  
90 mm



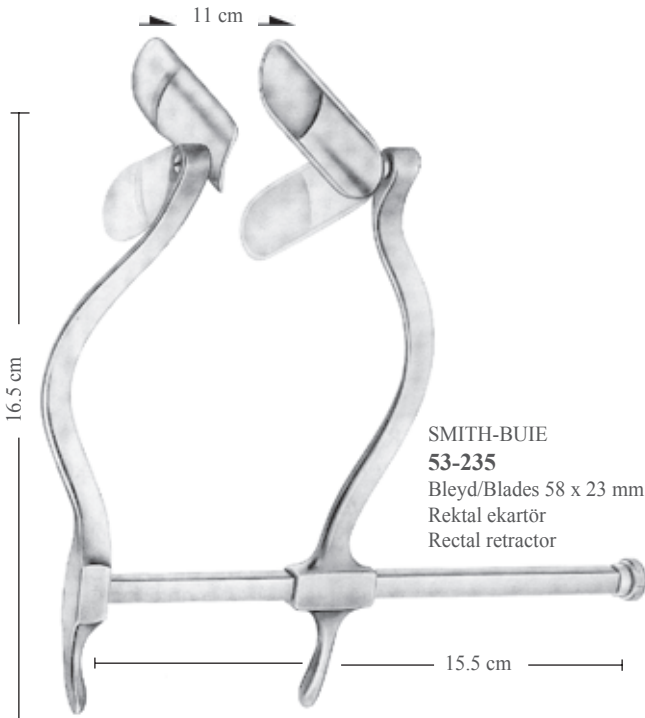
**53-232**  
150 mm



**53-234**

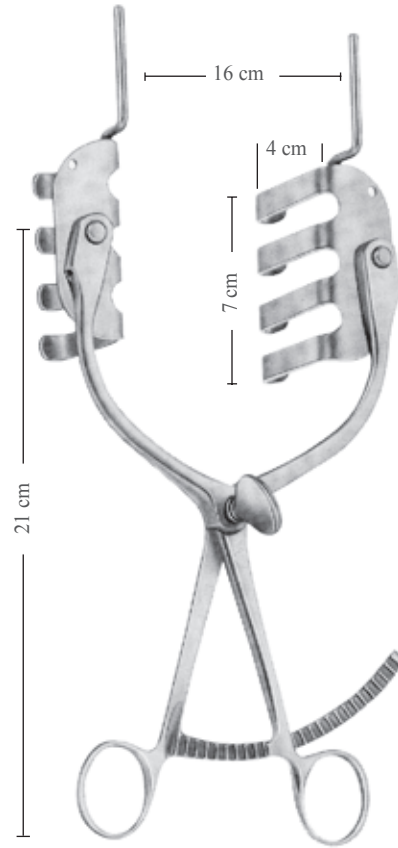
- Soğuk ışık taşıyıcı,  
operasyon alanını yoğun  
aydınlamak için  
Cold light carrier  
for additional, intensive  
illumination of the operatin-  
ing of the operating area

1/2



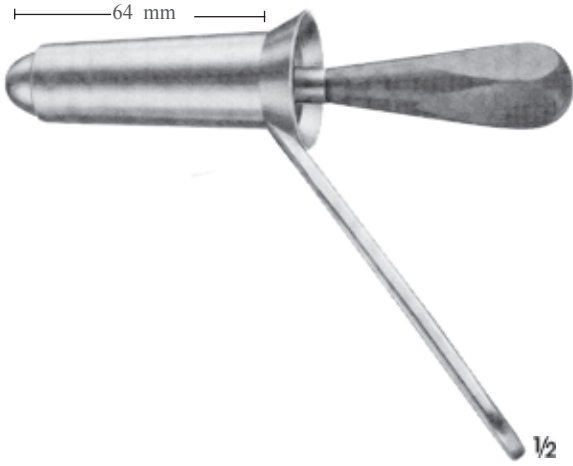
**SMITH-BUIE**

- 53-235**  
Bleyd/Blades 58 x 23 mm  
Rektal ekartör  
Rectal retractor

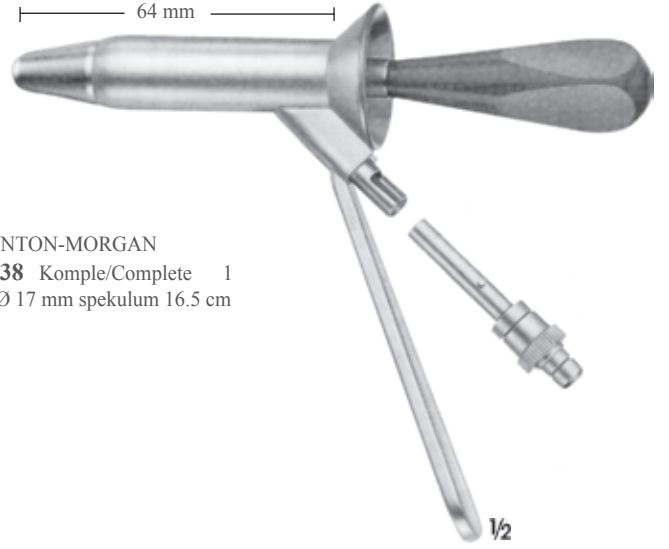


**ST.MARKS-GIRONA**

- 53-236**  
Perianal ekartör  
Perineal retractor



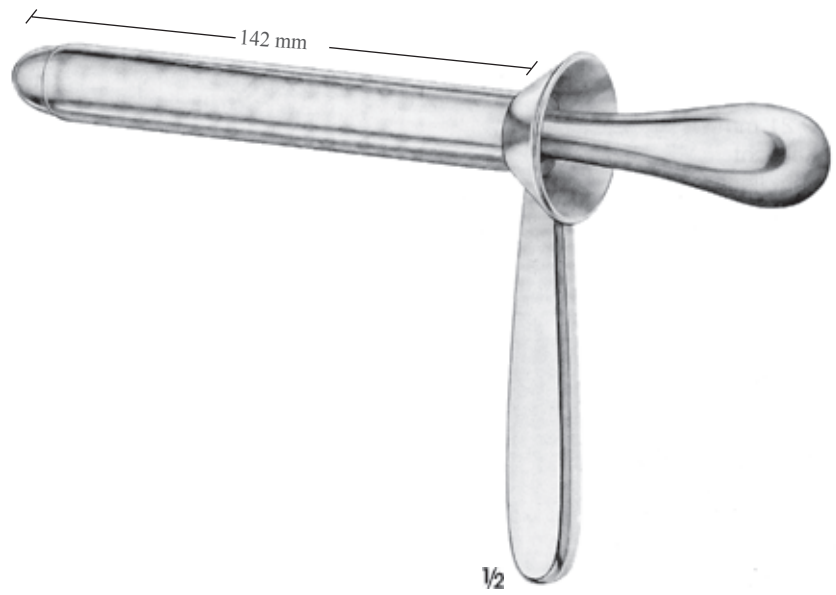
GABRIEL  
53-237 Ø 25 mm  
Rektal spekulum  
Rectal speculum



NAUNTON-MORGAN  
53-238 Komple/Complete 1  
adet Ø 17 mm spekulum 16.5 cm



53-239  
ACM İngiliz standartı fiber ışık taşıyıcı  
Fibre light attachment,  
ACM/British standard  
for NAUNTON-MORGAN specula

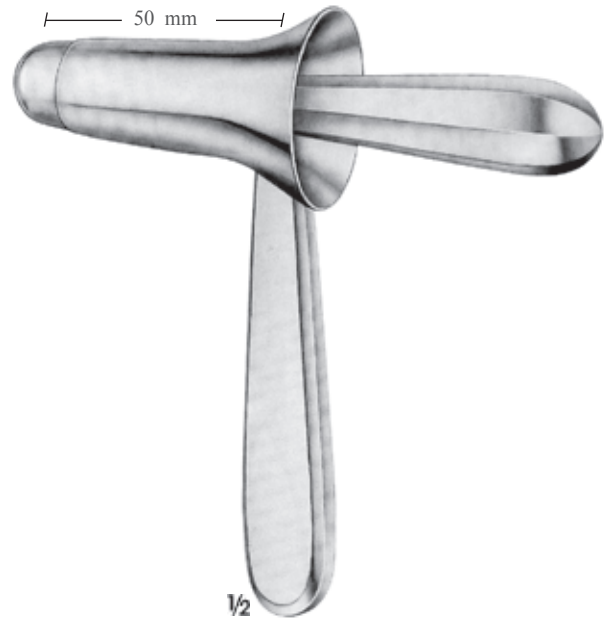


KELY  
53-240  
Proktoskop  
Proctoscope  
14 cm





KELLY  
53-241 Ø 20 mm  
Anoskop/Anoscope  
16 cm



KELLY  
53-242 Ø 25 mm  
Sfinteroskop/Sphincteroscope  
16 cm



IVES-FANSLER  
53-243 Ø 24 mm  
Anoskop/Anoscope  
14.5 cm



BENSAUDE  
53-244 Ø 17 mm  
53-245 Ø 20 mm  
53-246 Ø 23 mm  
Anoskoplar/Anoscopes  
18.5 cm

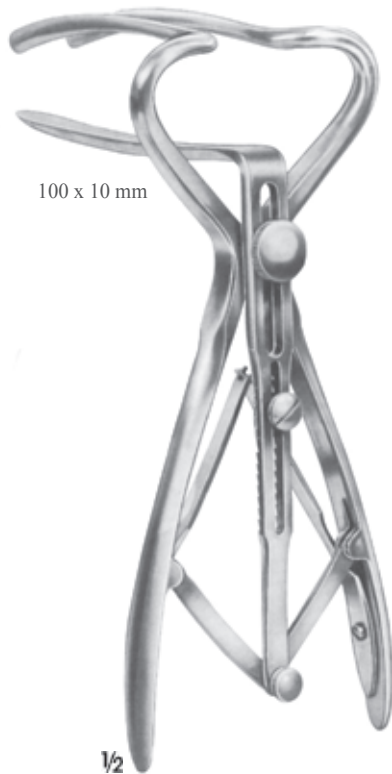




HIRSCHMANN  
53-247 Ø 16 x 65 mm  
53-248 Ø 19 x 65 mm  
53-249 Ø 22 x 65 mm



KELLY  
53-250 Ø 22 x 50 mm  
53-251 Ø 22 x 100 mm  
53-252 Ø 22 x 140 mm



100 x 10 mm

1/2

COCK  
53-253  
19 cm



1/2

SIMS  
53-254  
15 cm





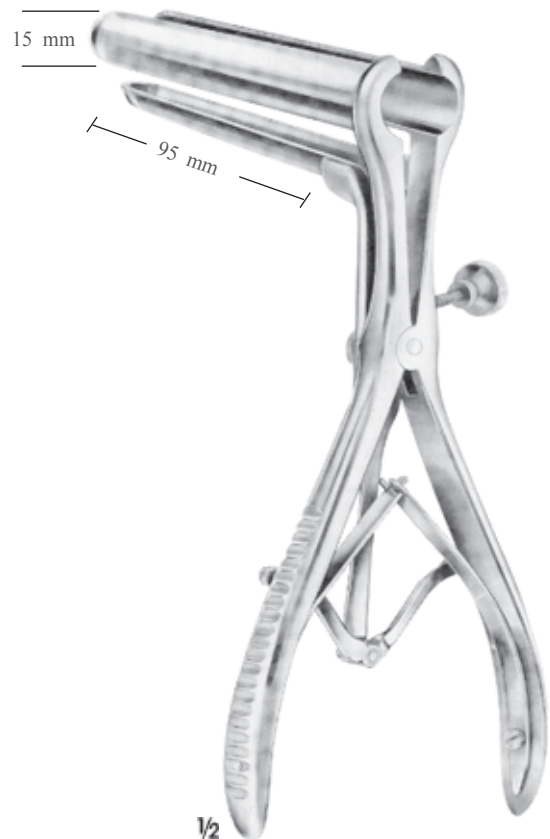
**1/2**  
SIMS  
53-255  
16 cm



**1/2**  
SIMS  
53-256  
16 cm



**1/2**  
PRATT  
53-257  
20.5 cm



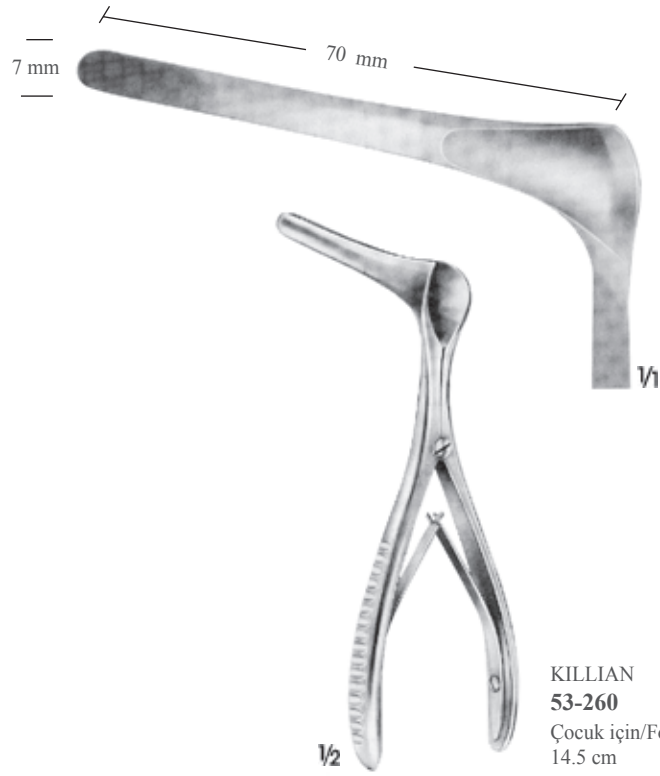
**1/2**  
MATHIEU  
53-258  
21.5 cm



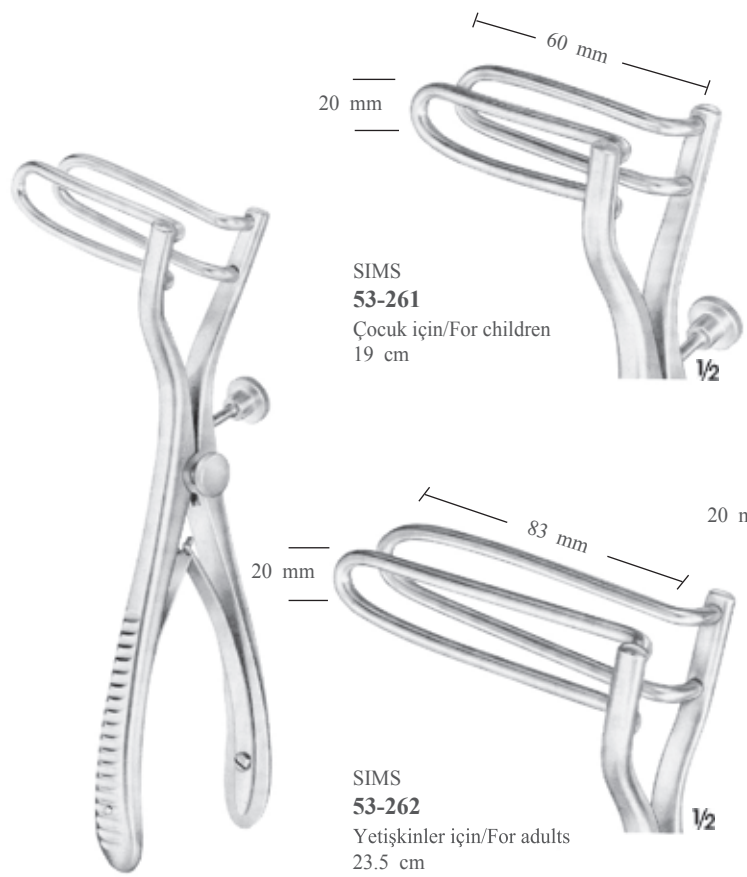




**CZERNY**  
**53-259**  
22.5 cm

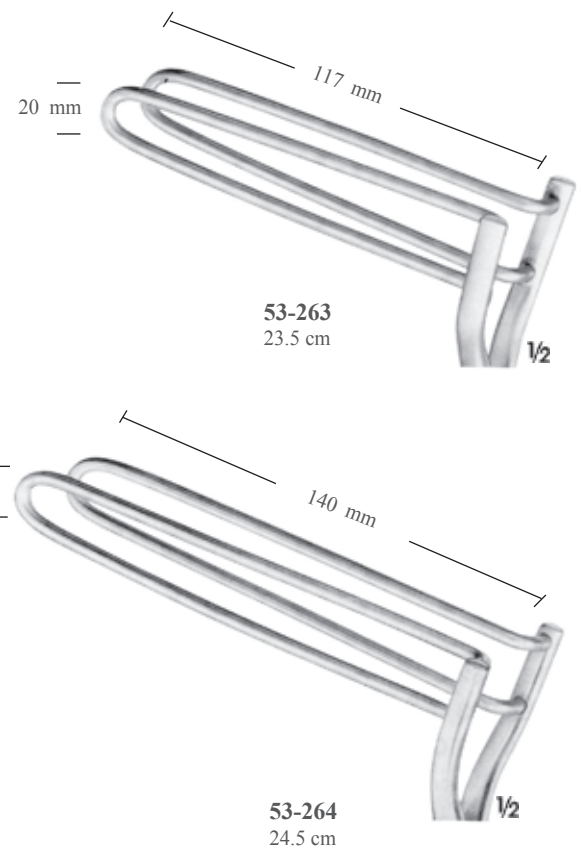


**KILLIAN**  
**53-260**  
Çocuk için/For children  
14.5 cm



**SIMS**  
**53-261**  
Çocuk için/For children  
19 cm

**SIMS**  
**53-262**  
Yetişkinler için/For adults  
23.5 cm

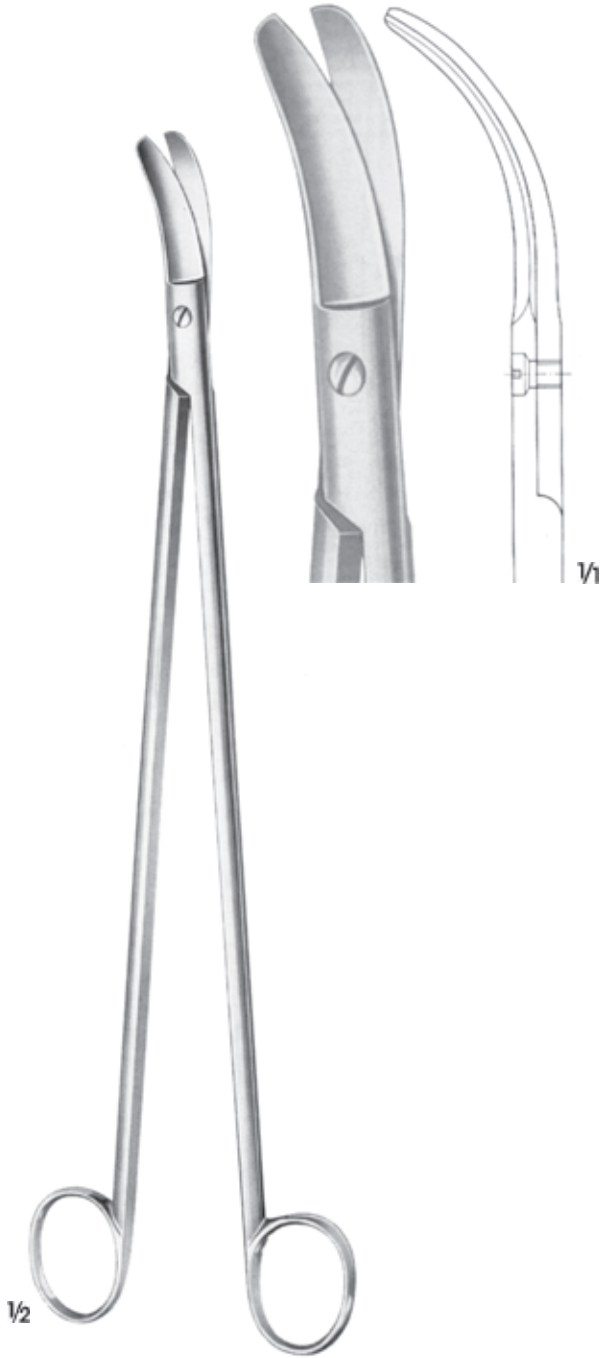


**53-263**  
23.5 cm

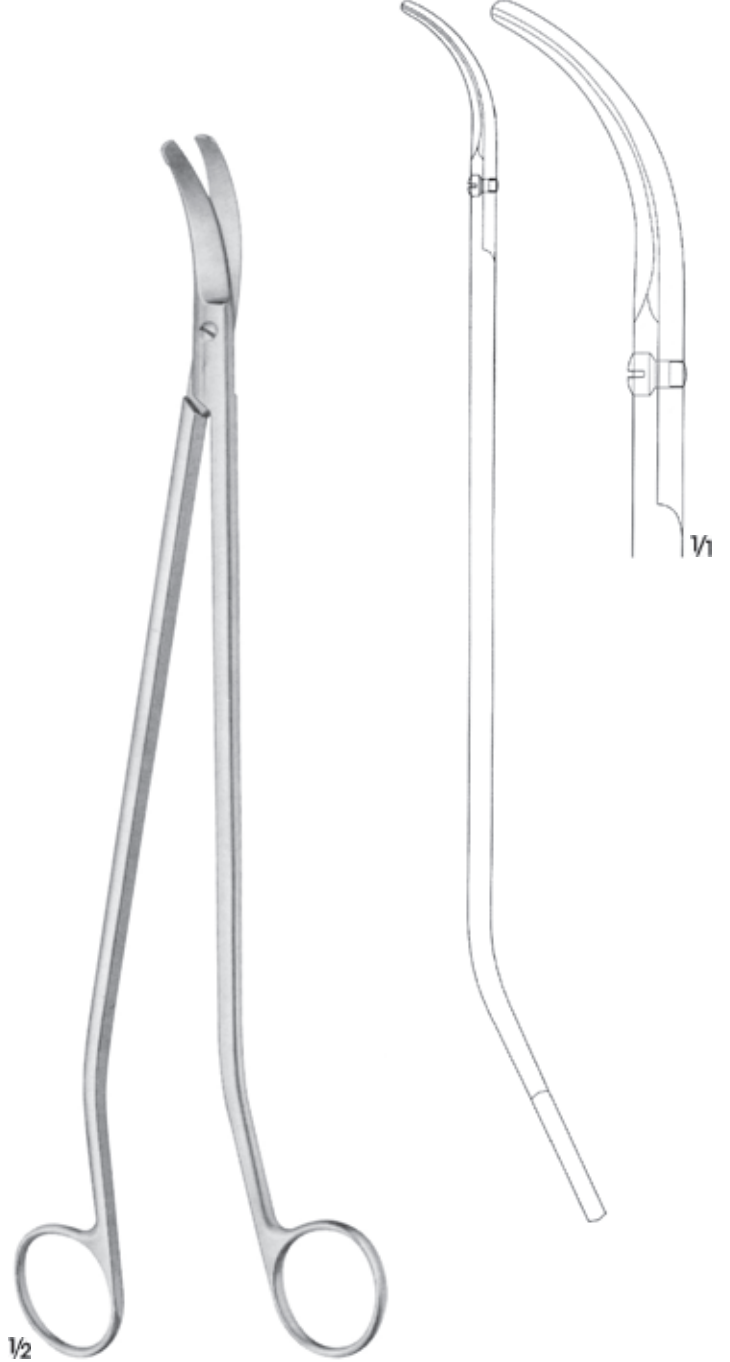
**53-264**  
24.5 cm







**53-265**  
Rektal makas  
Rectal scissors  
32.5 cm



**MÜLLER**  
**53-266**  
Rektum makas s şekli  
Rectum scissors s-shaped  
32.5 cm



**ALLIS**  
**53-267**  
Tutma pensi  
Grasping forceps  
29.5 cm

Atromatik  
Atraumatic



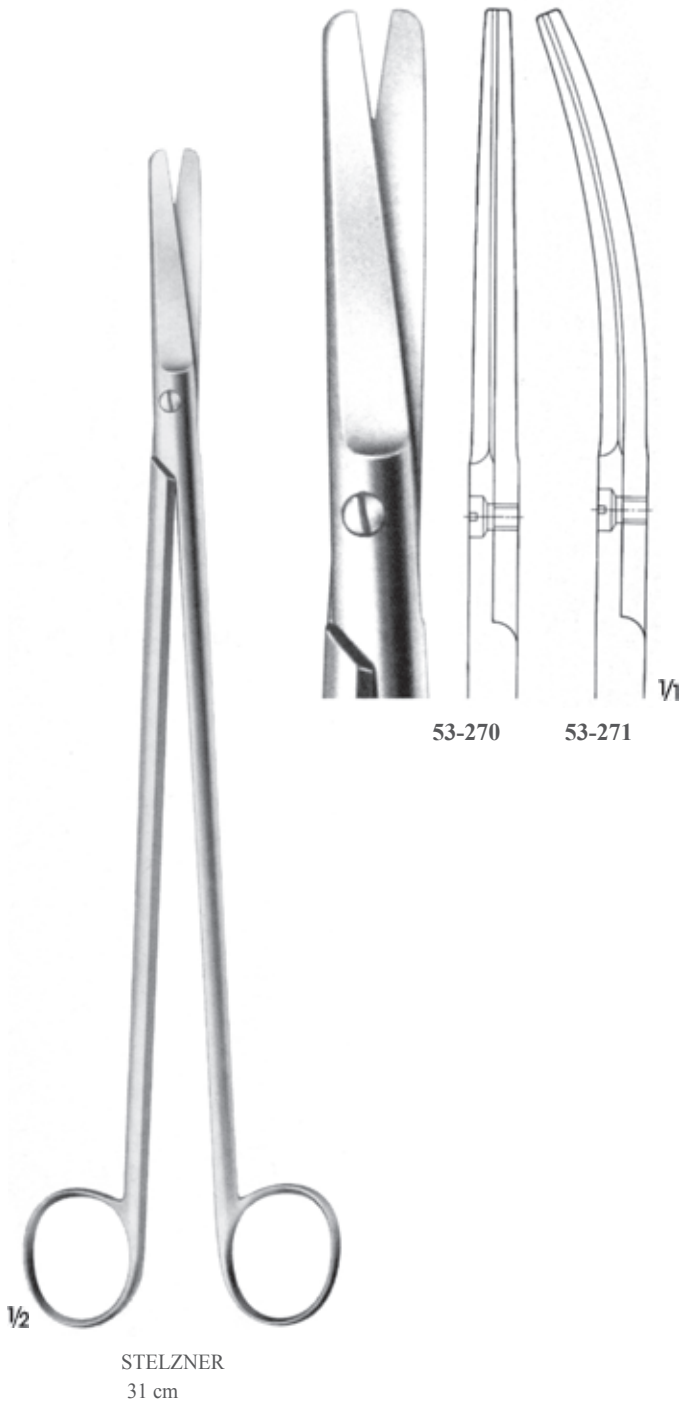
**DE BAKEY**  
**53-268**  
35 cm

HardTips  




**MÜLLER**  
**53-269**  
Portegü/Needle holder  
36 cm







PAYR  
53-272  
Çocuklar için bağırsak klempli  
Intestinal clamp light pattern,  
for children  
18 cm

PAYR  
53-273  
20 cm

PAYR  
53-274  
27.5 cm

PAYR  
53-275  
Pilor Klempli  
Pylorus clamp  
31.5 cm



KOCHER  
Soft and elastic

Yumuşak ve elastik



**53-276**  
Düz/Straight  
22 cm



**53-277**  
Düz/Straight  
25 cm



**53-278**  
Düz/Straight  
28 cm



**53-279**  
Eğri/Curved  
22 cm



**53-280**  
Eğri/Curved  
25 cm



**53-281**  
Eğri/Curved  
28 cm



V1



KOCHER  
Soft and elastic

Yumuşak ve elastik



53-282  
Düz/Straight  
22 cm



53-283  
Düz/Straight  
25 cm



53-284  
Düz/Straight  
28 cm



53-285  
Eğri/Curved  
22 cm



53-286  
Eğri/Curved  
25 cm



53-287  
Eğri/Curved  
28 cm







Atomatik  
Atraumatic



53-288

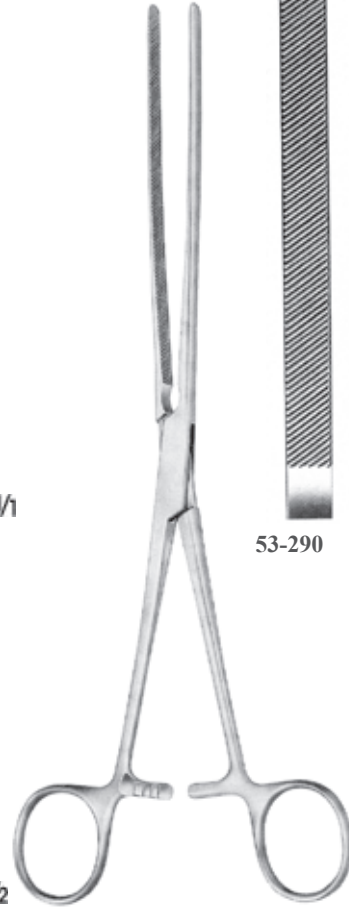
DOYEN

Yumuşak ve elastik  
Soft and elastic  
23 cm



53-289

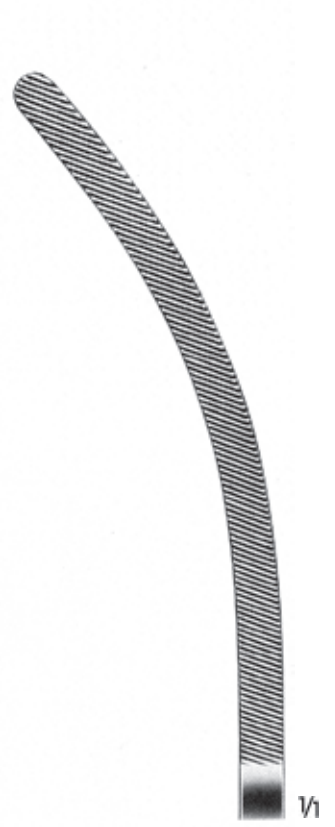
1/1



53-290

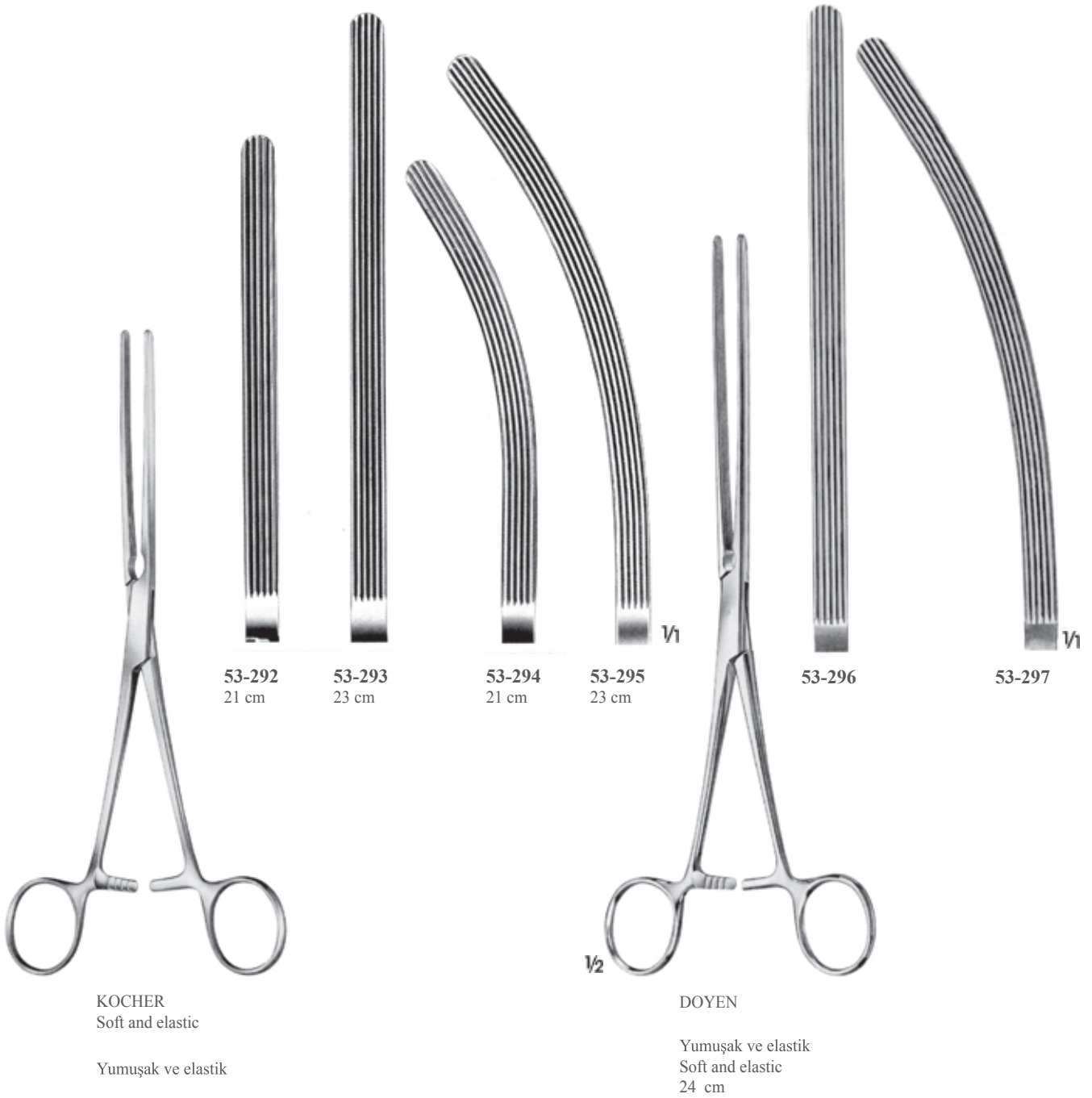
DOYEN

Yumuşak ve elastik  
Soft and elastic  
23.5 cm



53-291

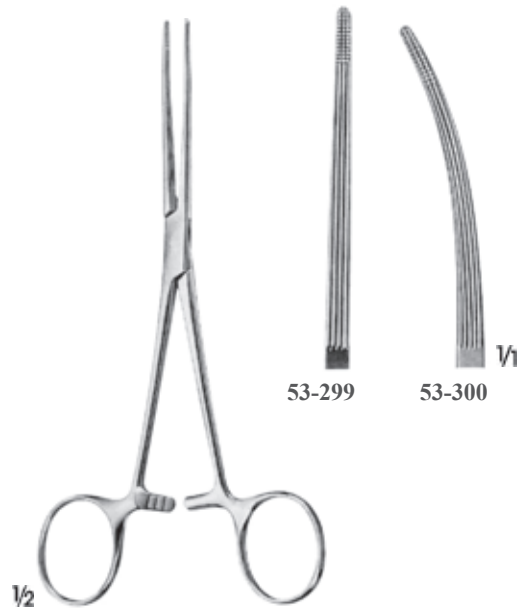
1/1



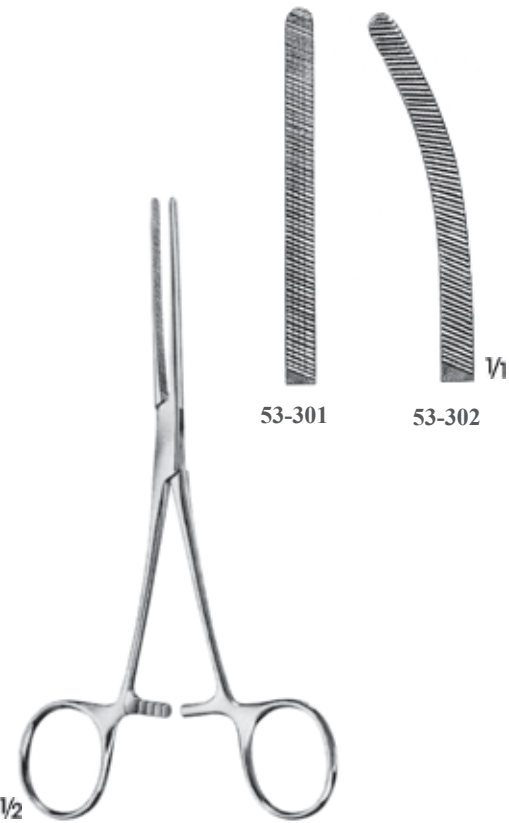




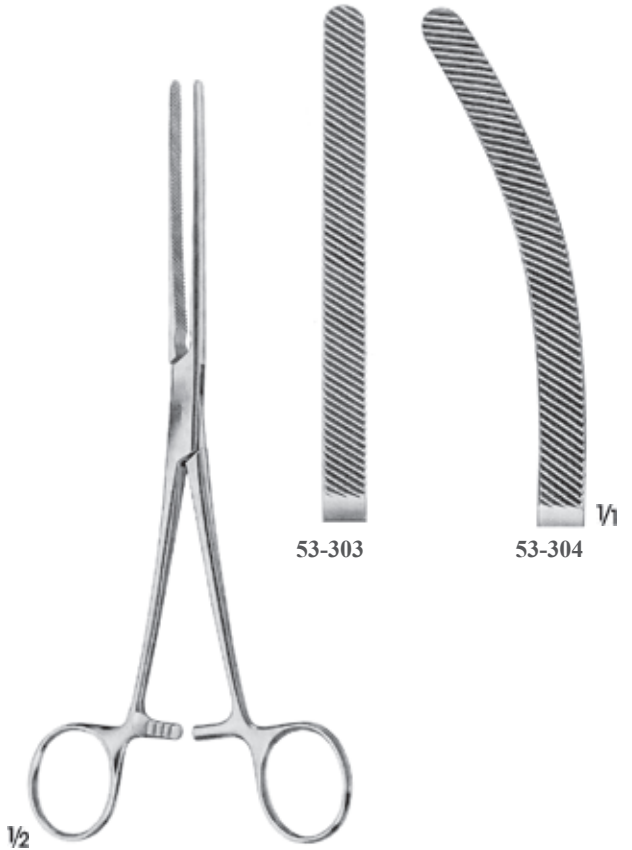
ALLEN  
53-298  
15.5 cm



BAINBRIDGE  
15.5 cm



DOYEN  
Elastik/Elastic  
16.5 cm

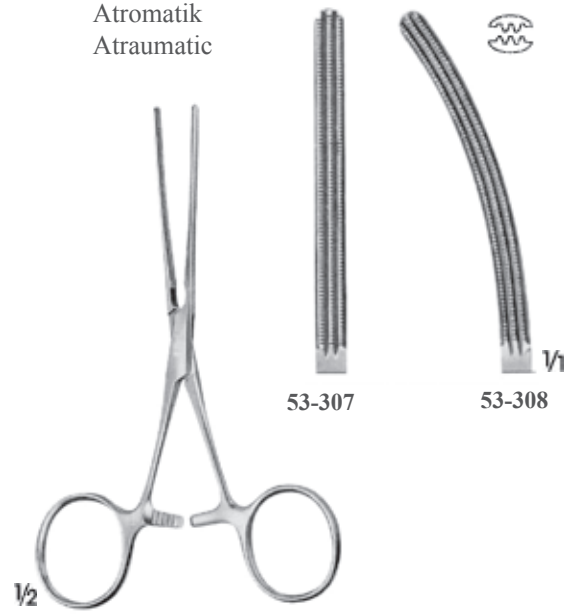


HARTMANN  
Yumuşak ve elastik  
20 cm



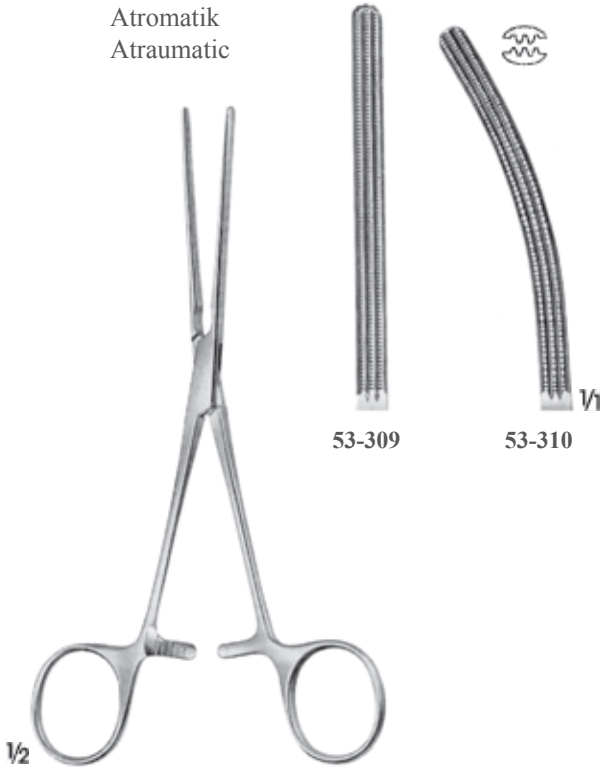


BABY-KOCHER  
Çocuklar için/For  
children Çok elastik/Very  
elastic 13 cm



BABY-KOCHER  
Çocuklar için/For children

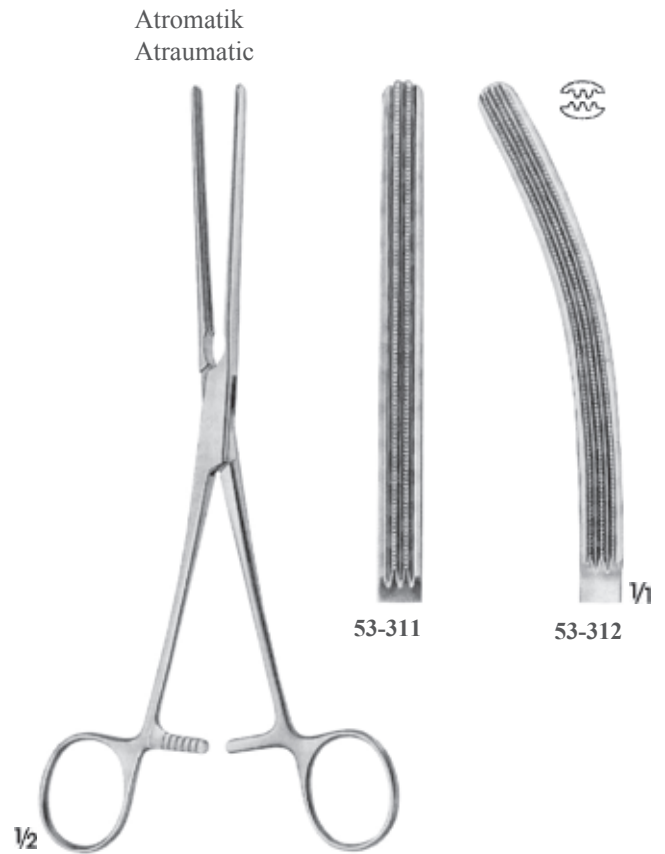
Yumuşak ve elastik/ Soft and elastic



Atromatik  
Atraumatic

DOYEN

Yumuşak ve elastik  
Soft and elastic  
17 cm



Atromatik  
Atraumatic

HARTMANN

Yumuşak ve elastik  
20 cm





1/2

MAYNIHAN  
53-313  
28 cm



1/1



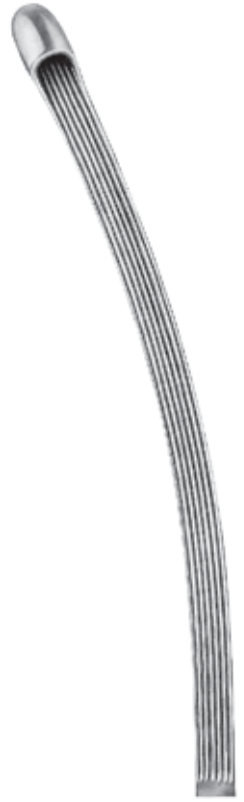
1/2

NUSSBAUM

Yumuşak ve elastik  
Soft and elastic  
25 cm

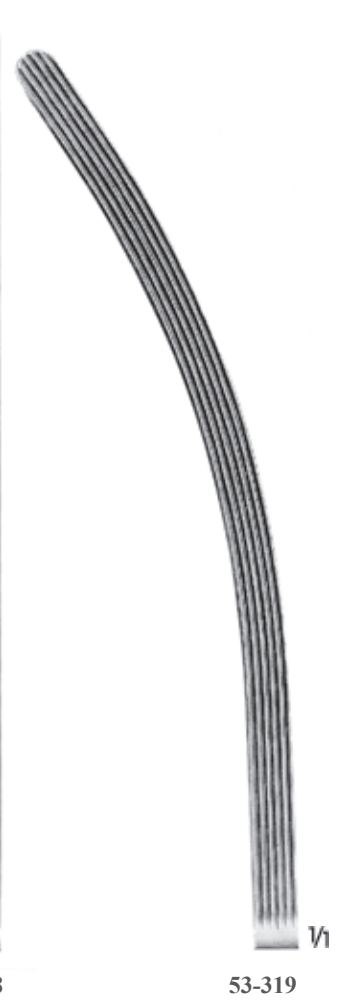
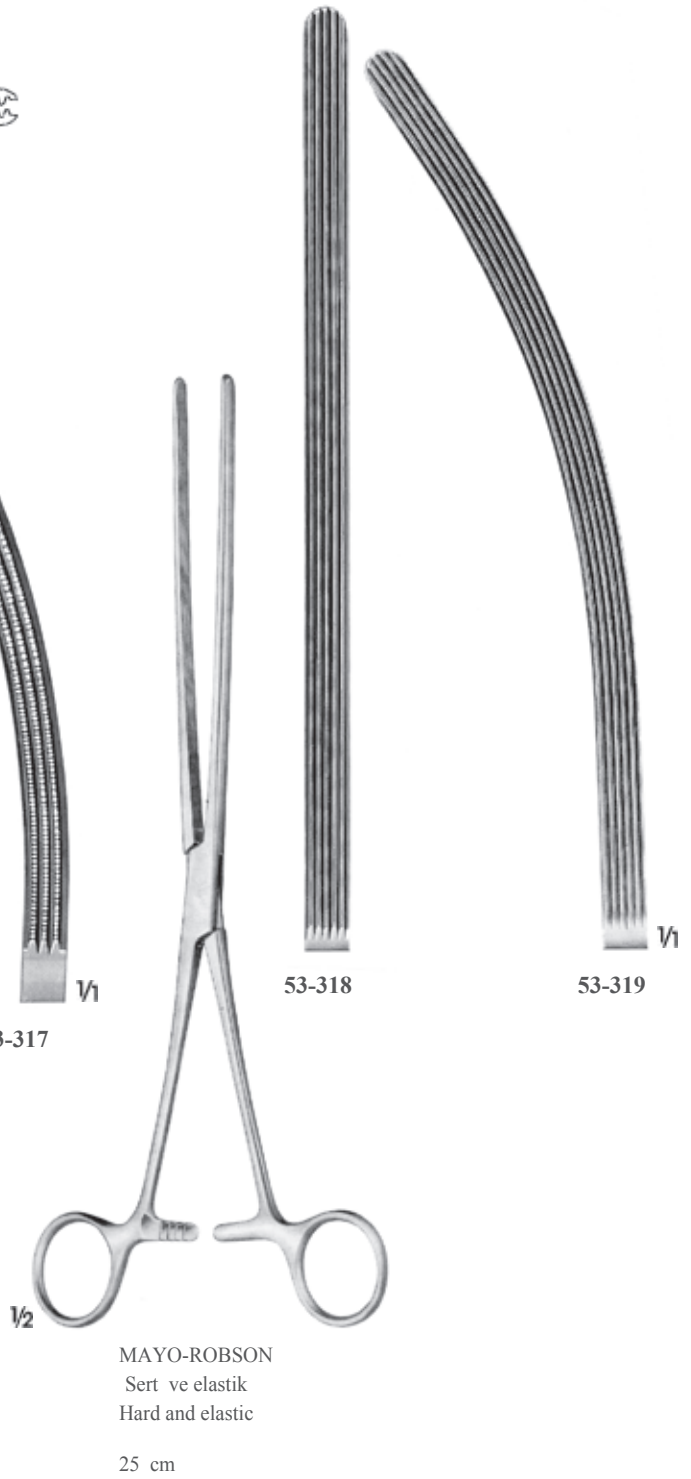


53-314



53-315 1/1

Atromatik  
Atraumatic





**SCHOEMAKER  
53-320**  
Kolektomi klempisi  
Colectomy clamp  
20 cm



**LANG-STEVENSON  
53-321**  
Bağırsak klempisi  
Intestinal clamp  
20 cm



**SCUDDER  
53-322**  
Mide klempisi  
Stomach clamp  
33 cm

Atromatik  
Atraumatic





**BENSON**  
**53-323**  
Pilor ayırıcı  
Pylorus spreader  
15.5 cm



**KLEINSCHMIDT**  
**53-324**  
Apendektomi klempe  
Appendectomy clamp  
13 cm



**DE MARTEL-WOLFSON**  
**53-325** 10 cm  
**53-326** 12 cm  
Anastomoz klempe, 3'lü set  
Anastomosis clamps,  
set of 3



**53-327** 22.5 cm  
Klempe tutucusu  
Clamp holder



Sert Klempe tutucu  
Clamp holder with set of clamps

**53-328** 8 cm  
Klempe tutucusu  
Clamp holder

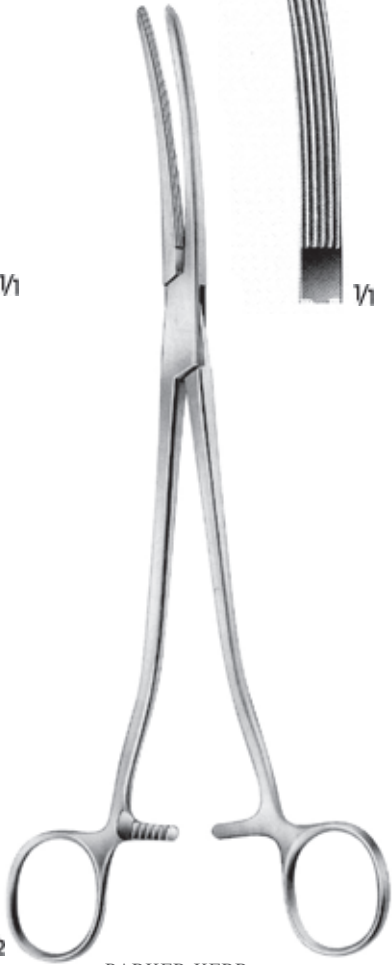


**DE MARTEL-WOLFSON**  
**53-329**  
Kapama pensu  
Closing forceps  
25 cm





1/1



PARKER-KERR  
**53-330** Anastomoz  
pensi, kolon rezeksiyonu  
için Anastomosis  
forceps for colon  
resection  
25 cm

Atromatik  
Atraumatic



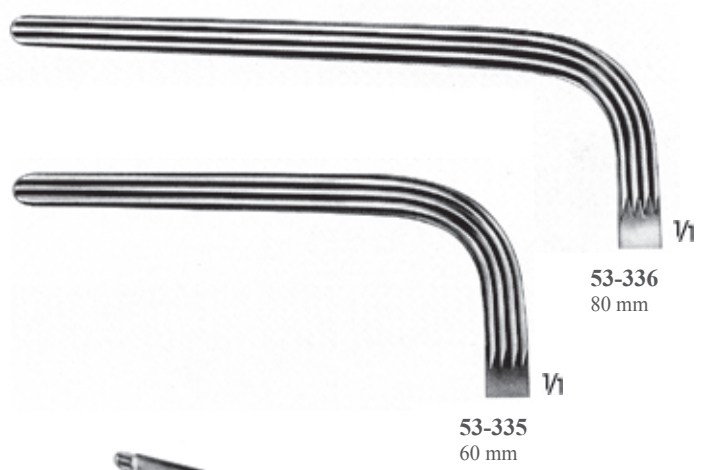
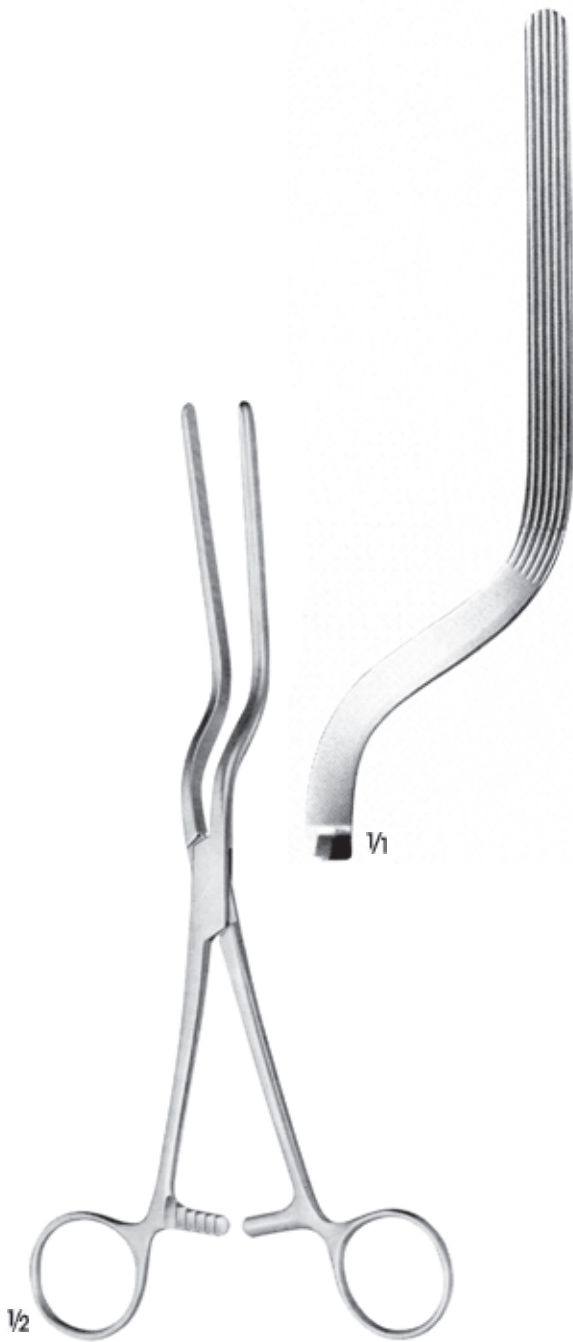
**53-331**  
78 mm

**53-332**  
88 mm

**53-333**  
98 mm

DICK  
**53-331** 25.5 cm  
**53-332** 26.5 cm  
**53-333** 27.5 cm  
Güçlü klempler  
Pressure clamps

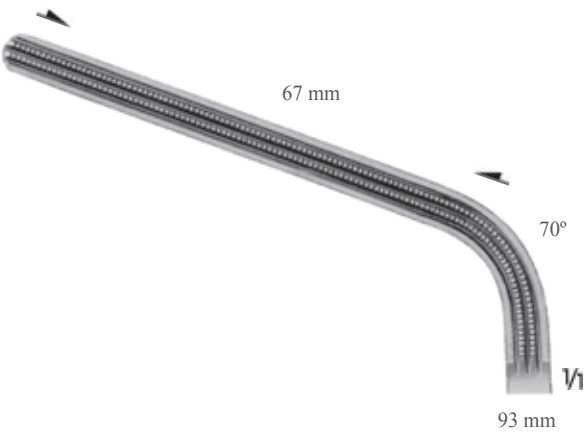




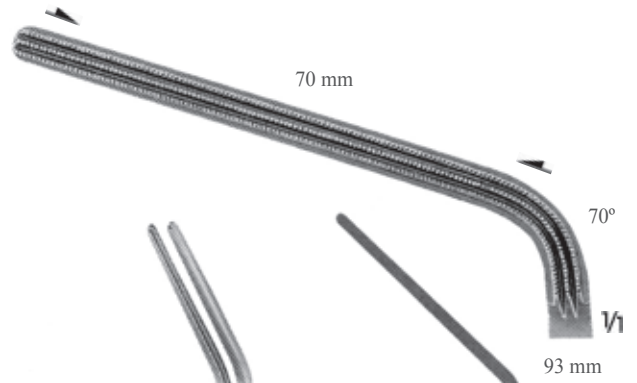




LLOYD-DAVIS  
53-337  
31.5 cm

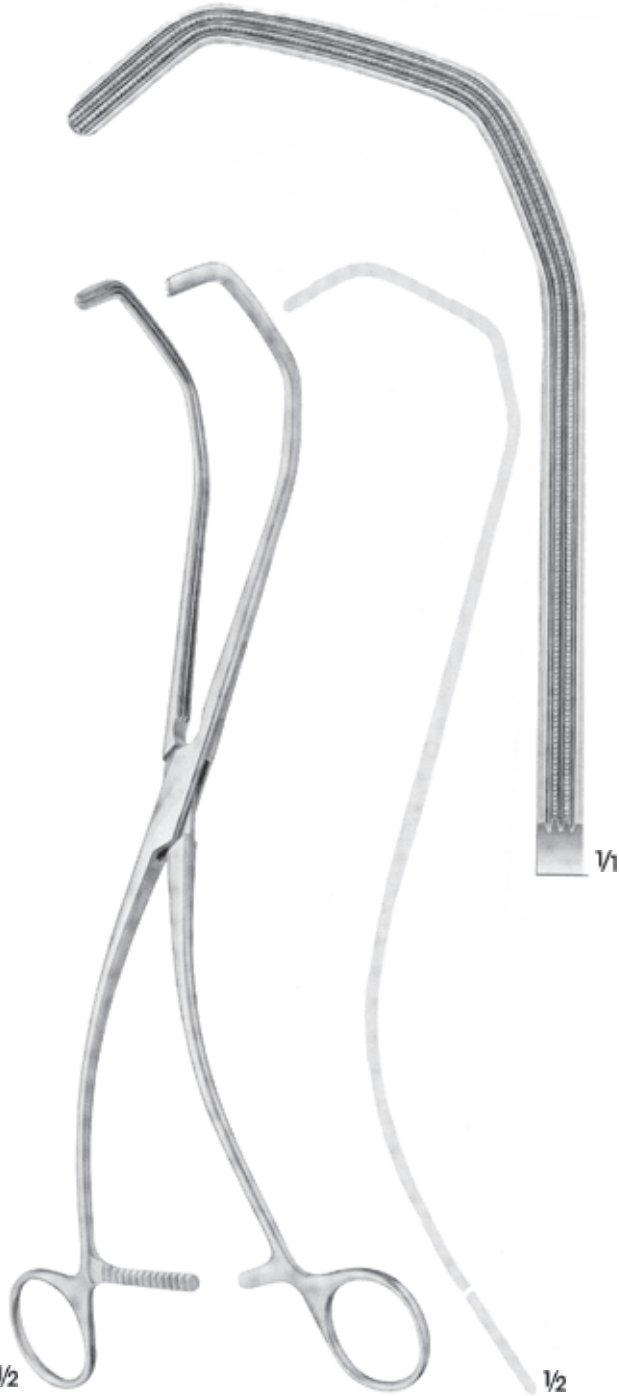


MORRIS  
53-338  
17.5 cm



DE BAKEY (MORRIS)  
53-339  
24 cm

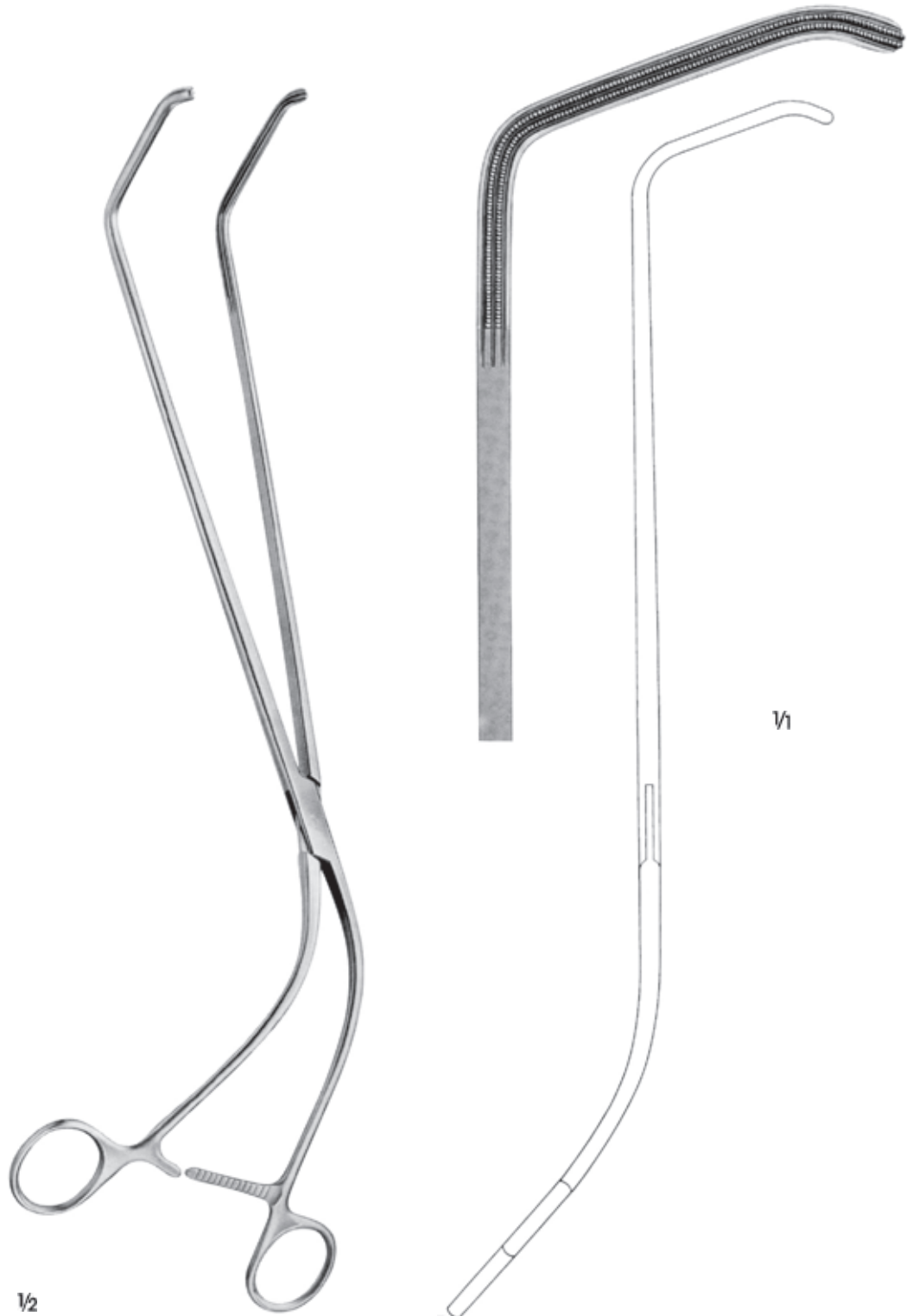




**KERSTING**  
**53-340**  
30 cm



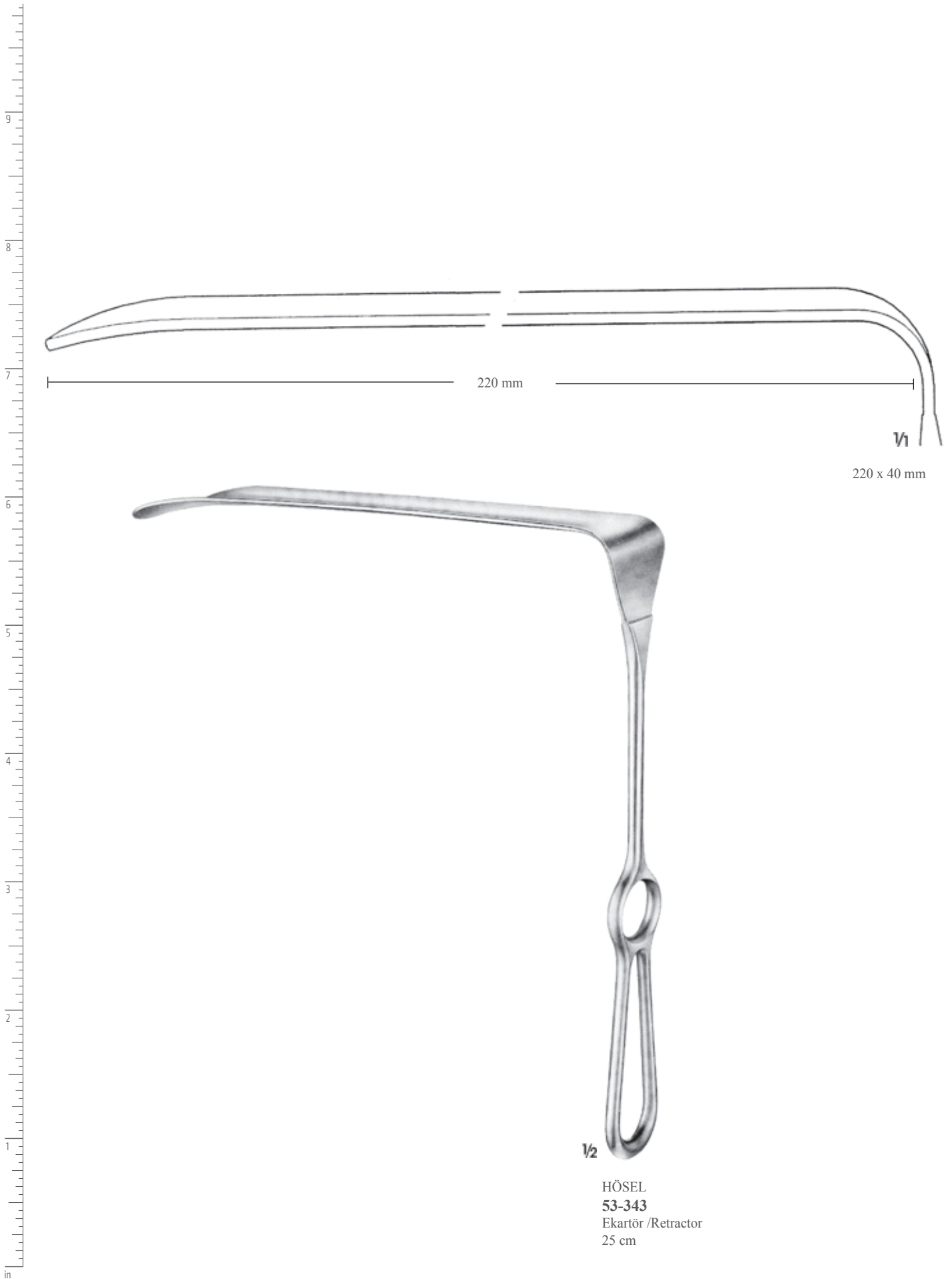
**RESONE**  
**53-341**  
Yumuşak/Elastic  
26.5 cm

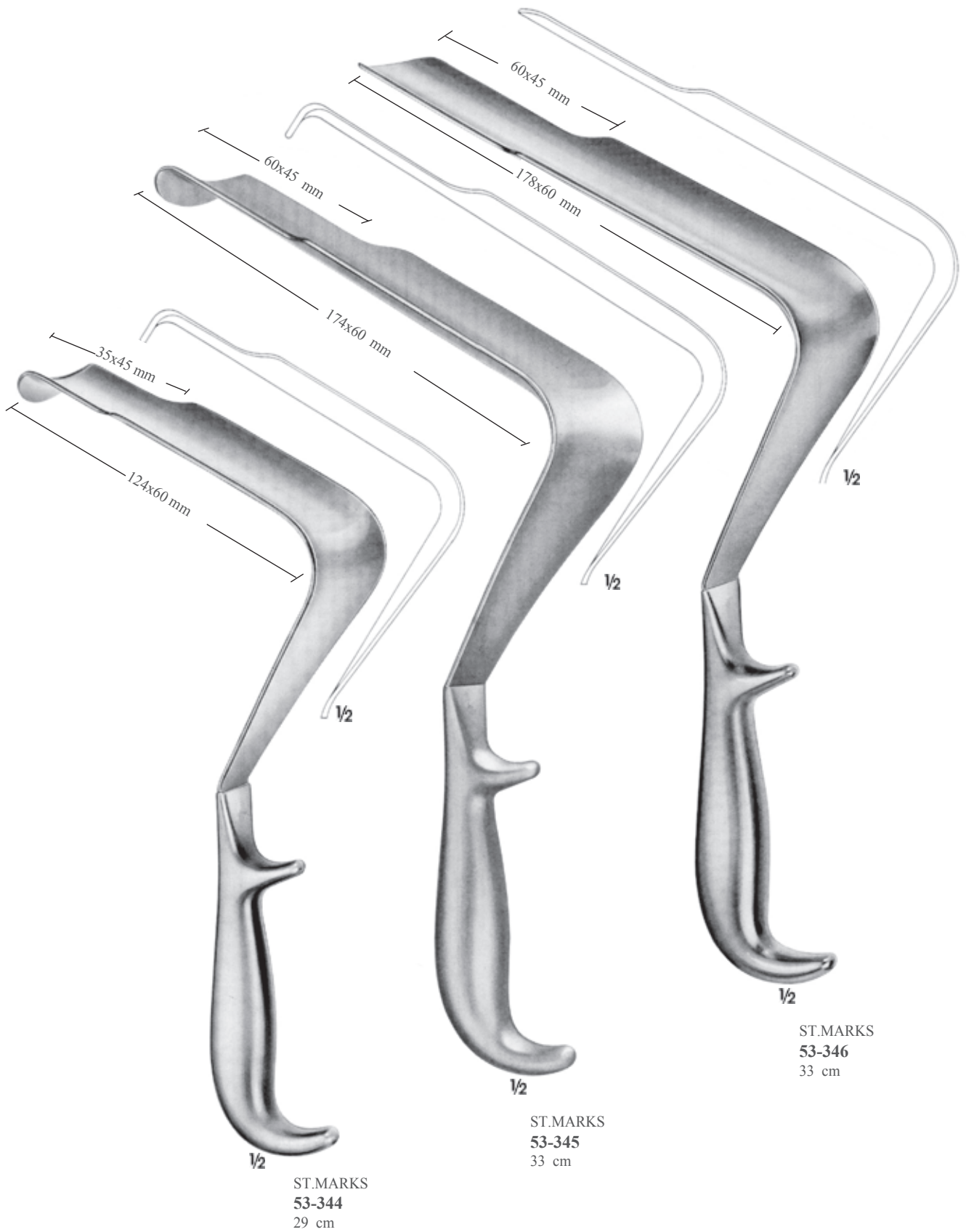


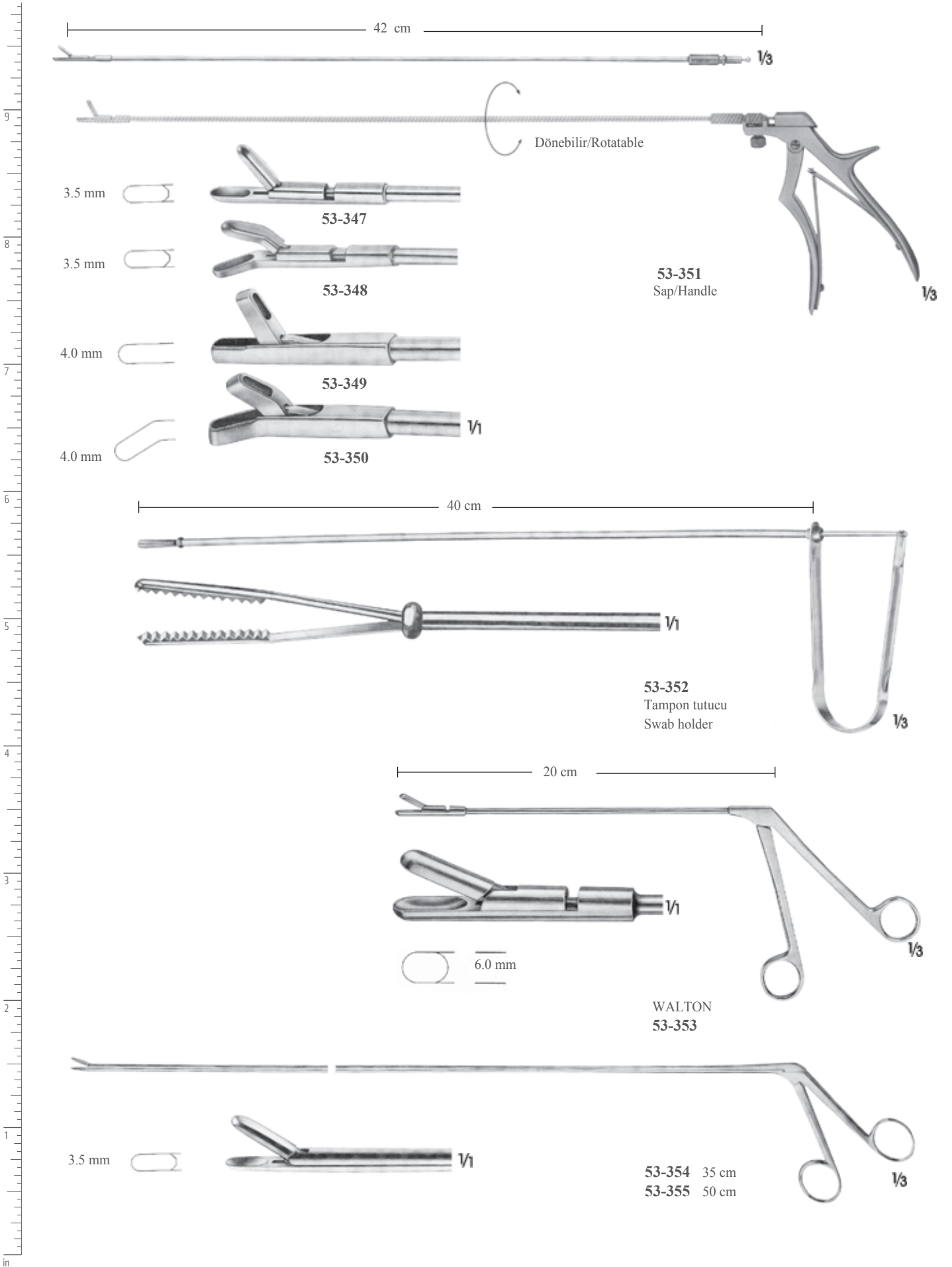
1/2

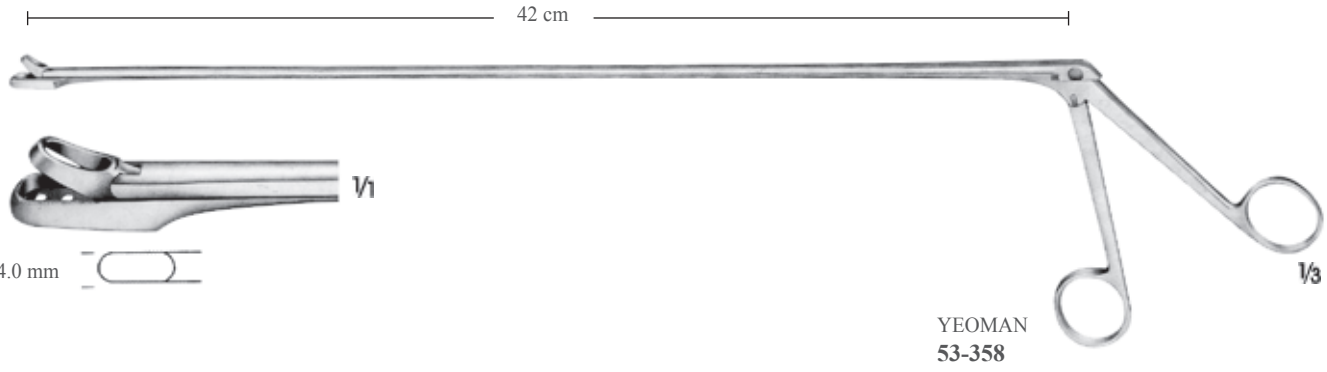
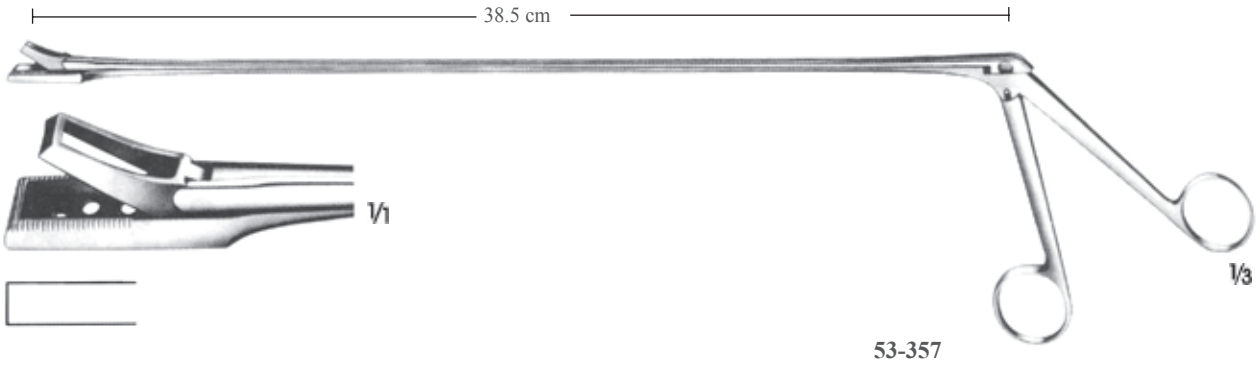
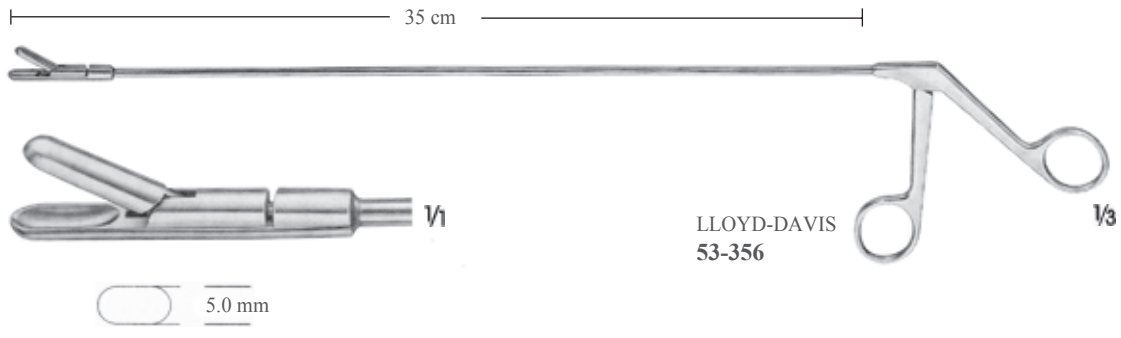
MULLER  
**53-342**  
Rektal anastomoz klemp  
Rectal anastomosis clamp  
37.5 cm















53-359



53-360



53-361



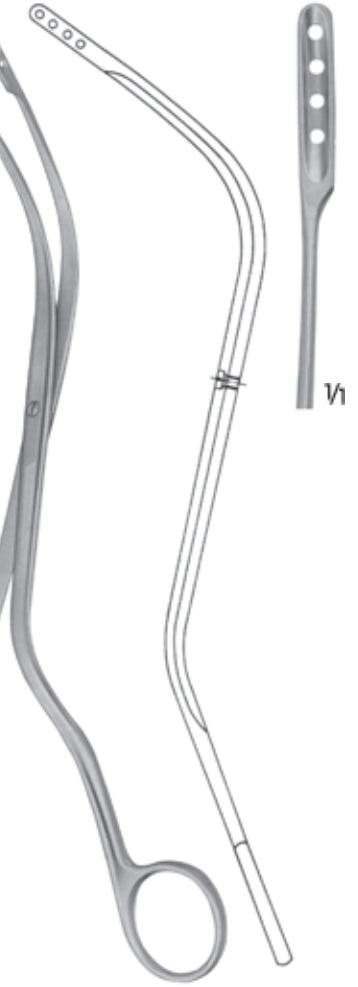
53-362



53-363  
24 cm



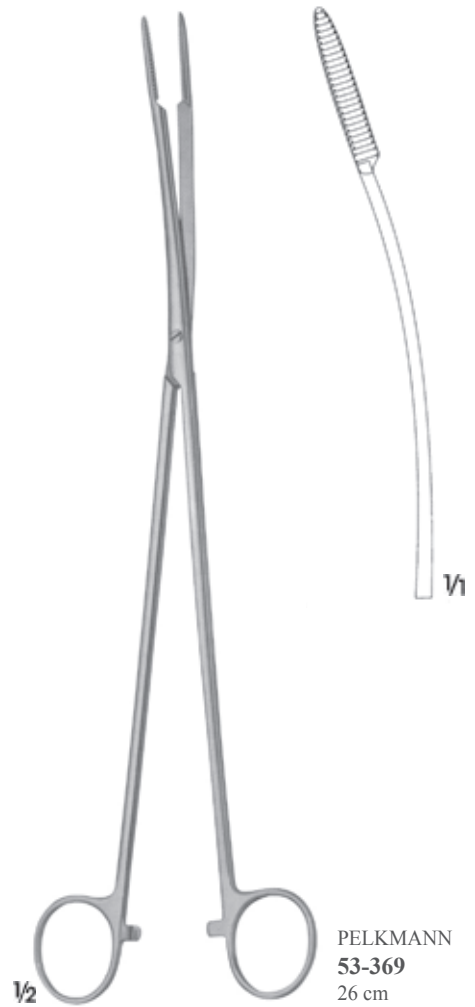
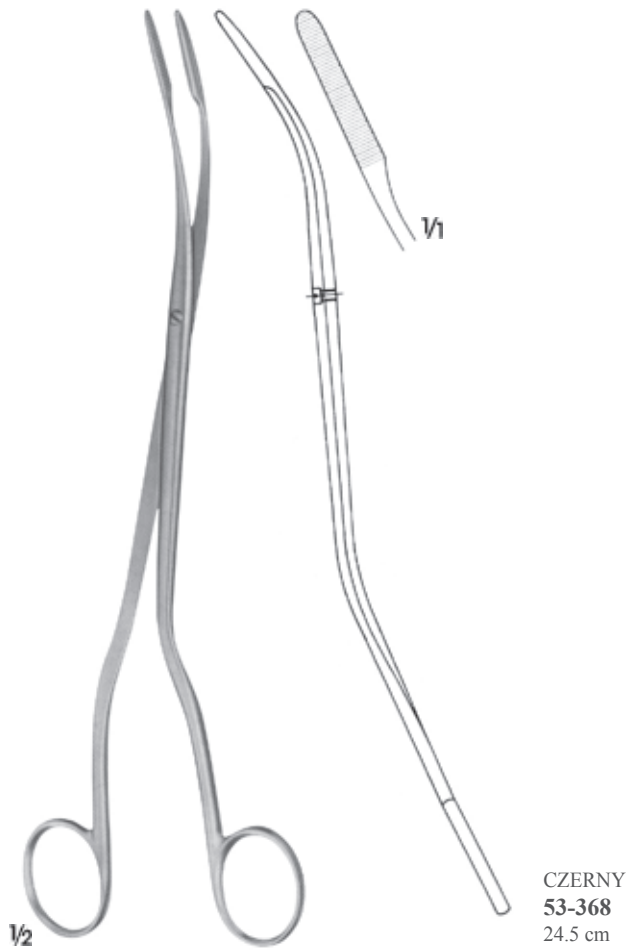
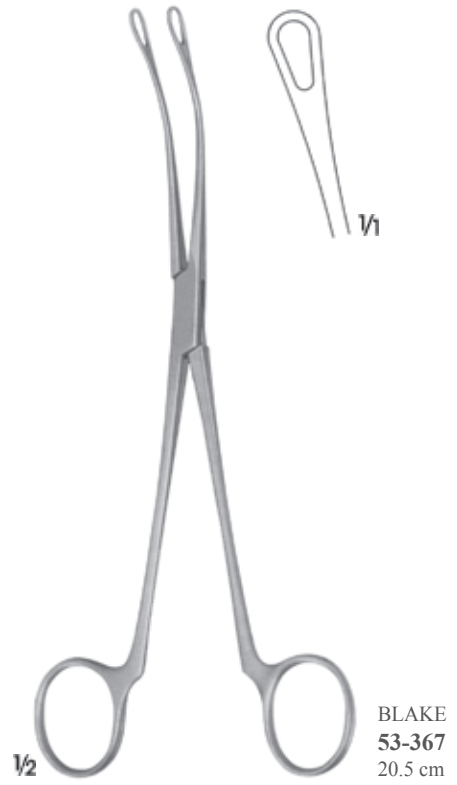
53-364  
22.5 cm



TÜBINGER  
53-365  
25.5 cm

DESJARDINS  
22.5 cm

DESJARDINS  
Hassas model  
Extremely delicate patterns





1/2

HABERER  
53-370  
36 cm



1/1

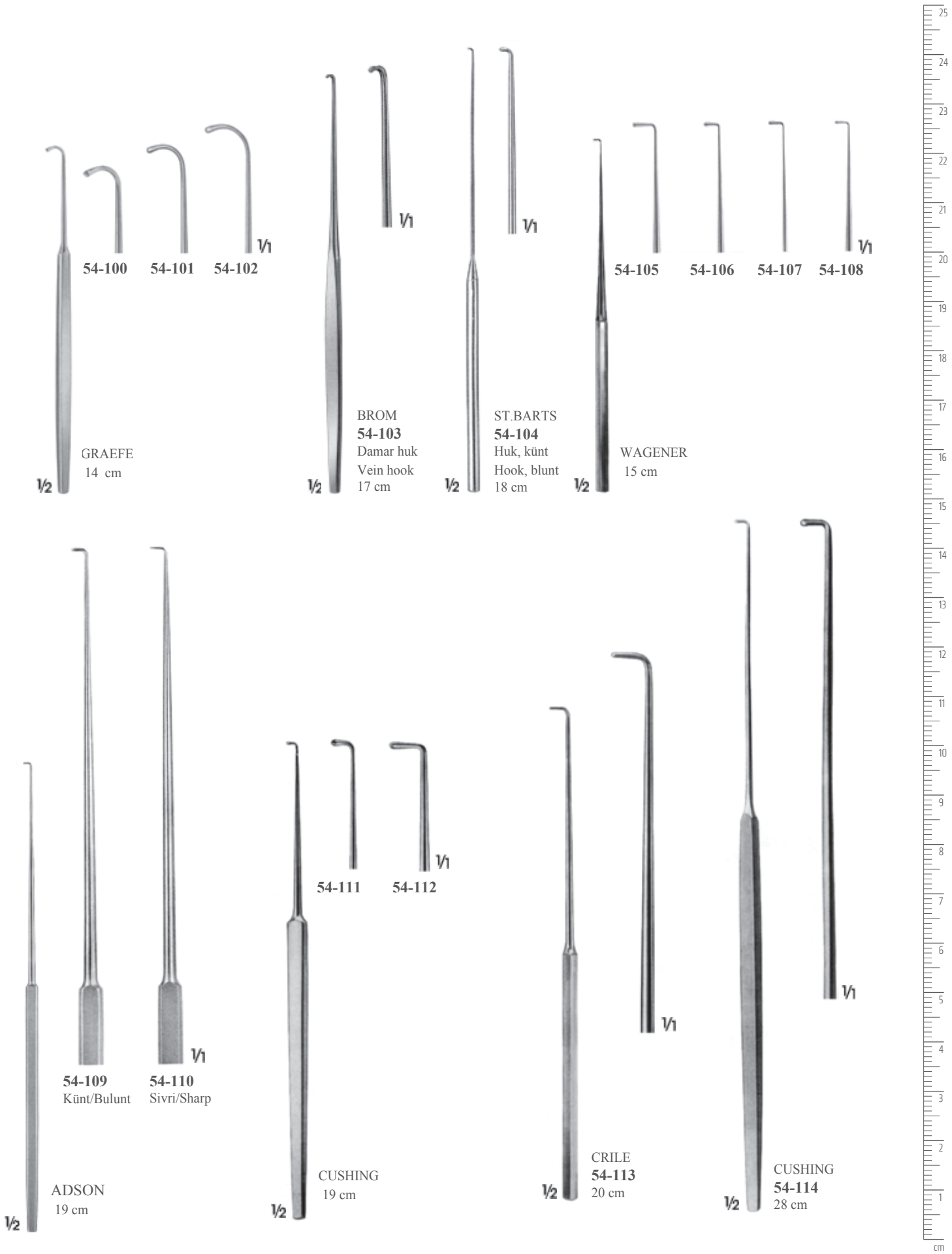


LANE  
53-371  
31 cm

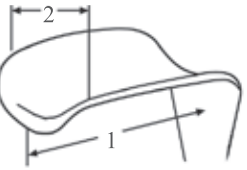
LANE  
53-372  
31 cm

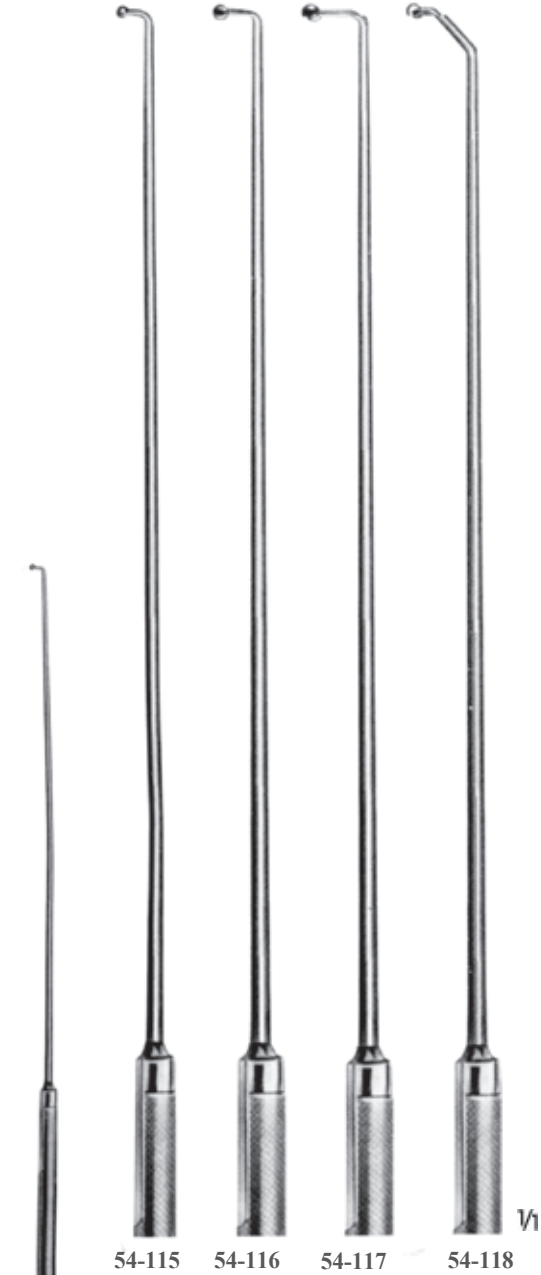


**54**

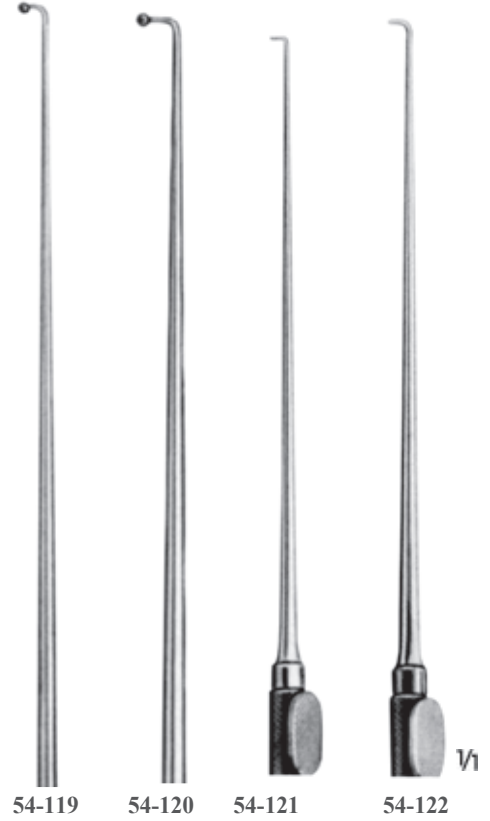




	<p>Ekartörler için ölçü sistemiM</p> <p>Derinlik :1 Genişlik :2</p> <p>Örnek:1 x 2</p>	<p>Measurement system for retractor blades</p> <p>Depth:1 Width :2</p> <p>Example:1 x 2</p>
---	--	---

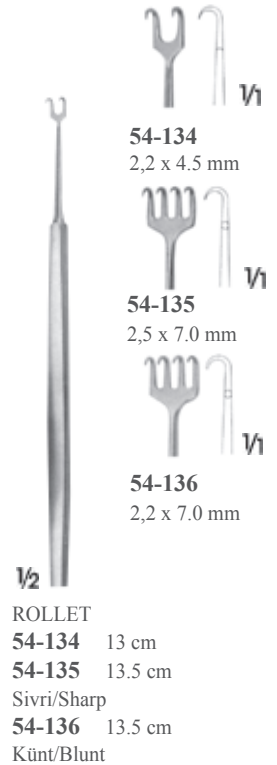


CASPAR  
Keşif prob uçlu, huklar  
Exploration hooks, probe-ended  
24.5 cm



KRAYENBÜLH  
18.5 cm







**BERGMANN**  
**54-137**  
14 cm



**54-138**



**BOSE**  
**54-139**  
16.5 cm



18 cm



**54-141**  
Künt/Blunt



**54-140**  
Sivri/Sharp



**54-142**  
Künt/Blunt



Esnek, şaft/Flexible shaft  
Sivri/Sharp  
15.5 cm



**54-143**  
3.5 x 4.5 mm



**54-144**  
4.0 x 7.2 mm



**54-145**  
4.0 x 10.0 mm



**54-146**  
4.0 x 4.5 mm<sup>4</sup>



**54-147**  
.0 x 7.5 mm<sup>4</sup>



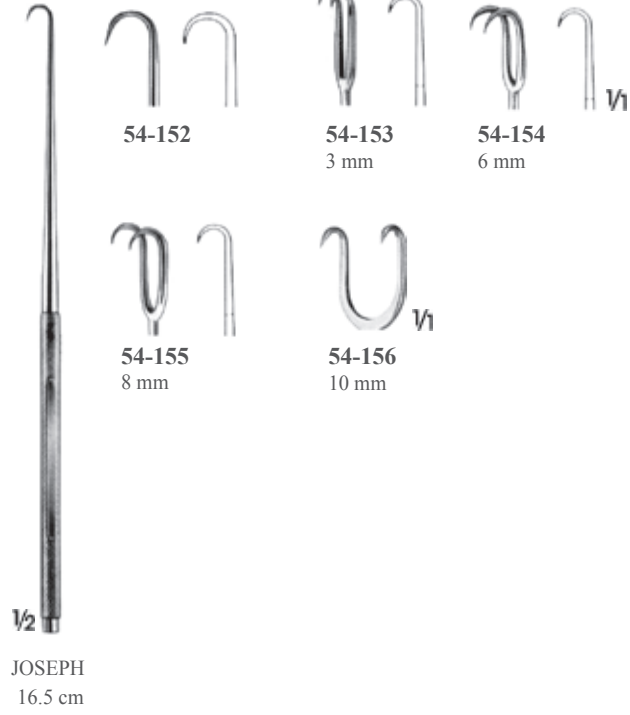
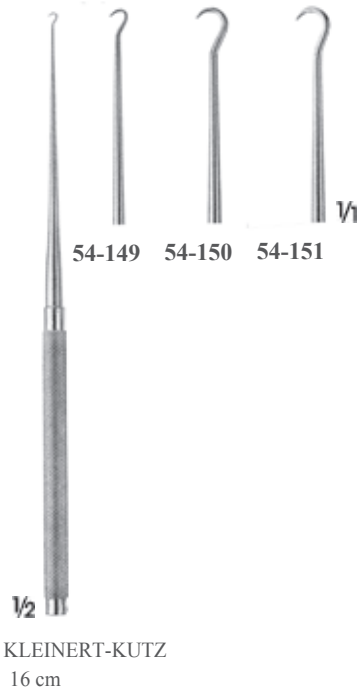
**54-148**  
.0 x 10.2 mm<sup>4</sup>



Esnek, şaft/Flexible shaf  
Künt/Blunt  
15.5 cm

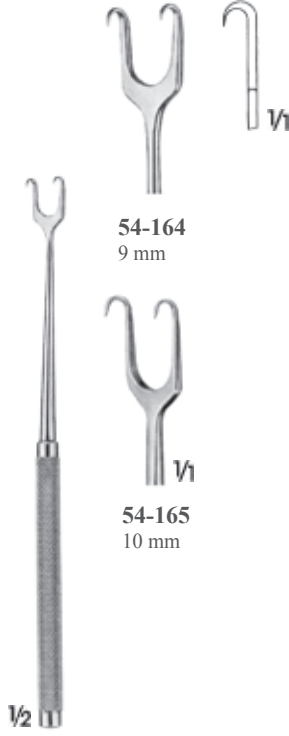


İnce Yara Ekartörleri (Dura ve Cilt Ekartörleri)  
Fine Wound Retractors (Dura and Skin Retractors)





**FISCH**  
**54-163**  
Dura ekartör  
Dura retractor  
18.5 cm



**MC INDOE**  
15 cm

**54-164**  
9 mm

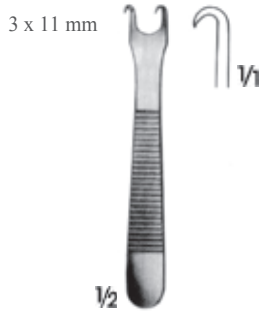
**54-165**  
10 mm



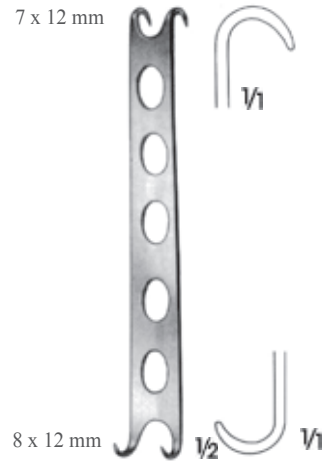
**54-166**  
Ø 1.8 mm

Sterilizasyon koruyucu  
Protector for storing and sterilization

Doku piki/Tissue pick  
Doku ve deriyi yakalayıp  
kaldırmak için çift uçlu  
Double picks to grasp and  
lift skin, tissue etc  
18.5 cm



**KILNER**  
**54-167**  
Sivri/Sharp  
8 cm



**CONVERSE**  
**54-168**  
Künt/Blunt  
12 cm



MANNERFELT  
**54-169**  
Sivri/Sharp  
13.5 cm



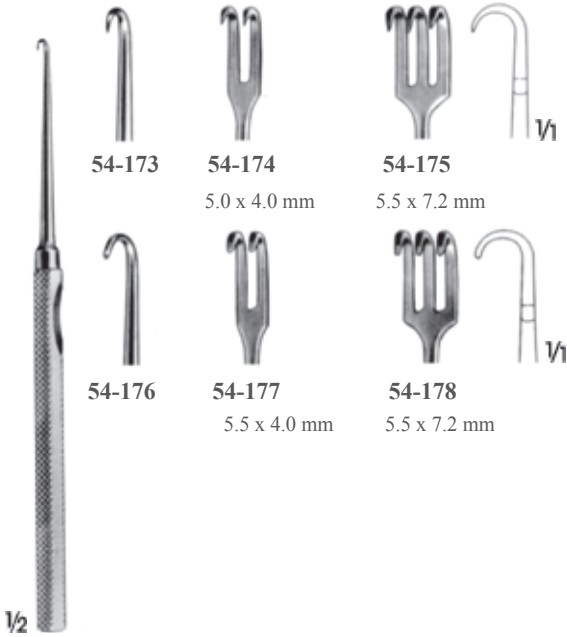
MANNERFELT  
**54-170**  
Sivri/Sharp  
15.5 cm



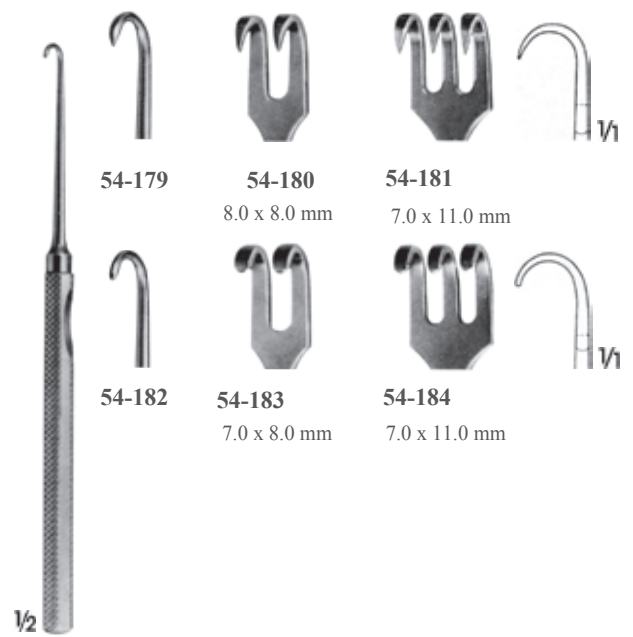
MANNERFELT  
**54-171**  
Sivri/Sharp  
15.5 cm



MANNERFELT  
**54-172**  
Esnek shaft küçük eğri, sivri  
Flexible shaft, small curve, sharp  
15.5 cm

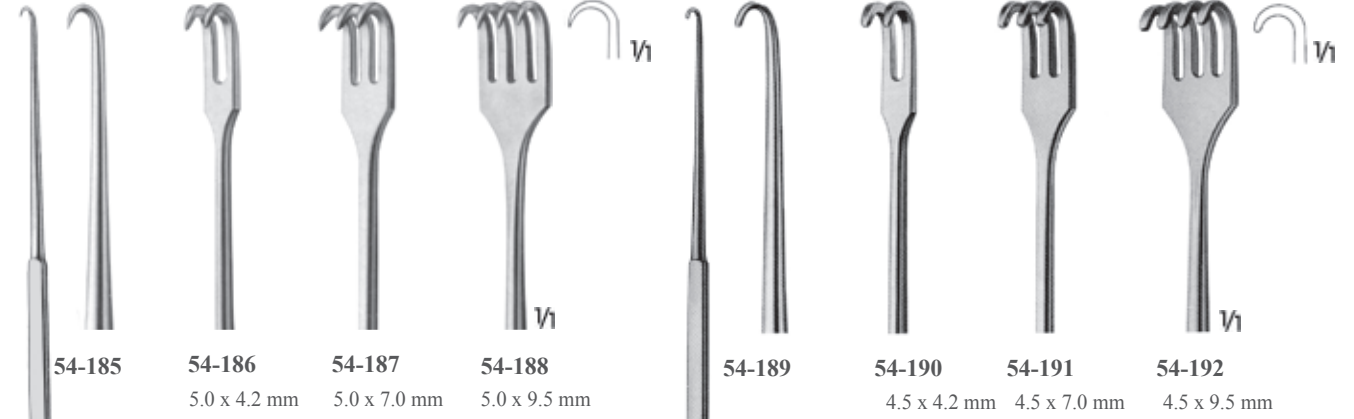


MANNERFELT  
**54-173 - 54-175** Sivri/Sharp  
**54-176 - 54-178** Künt/Blunt  
Küçük eğri/Small curve  
15.5 cm



MANNERFELT  
**54-179 - 54-181** Sivri/Sharp  
**54-182 - 54-184** Künt/Blunt  
Büyük eğri/Large curve  
15.5 cm





54-185

54-186

5.0 x 4.2 mm

54-187

5.0 x 7.0 mm

54-188

5.0 x 9.5 mm

54-189

54-190

4.5 x 4.2 mm

54-191

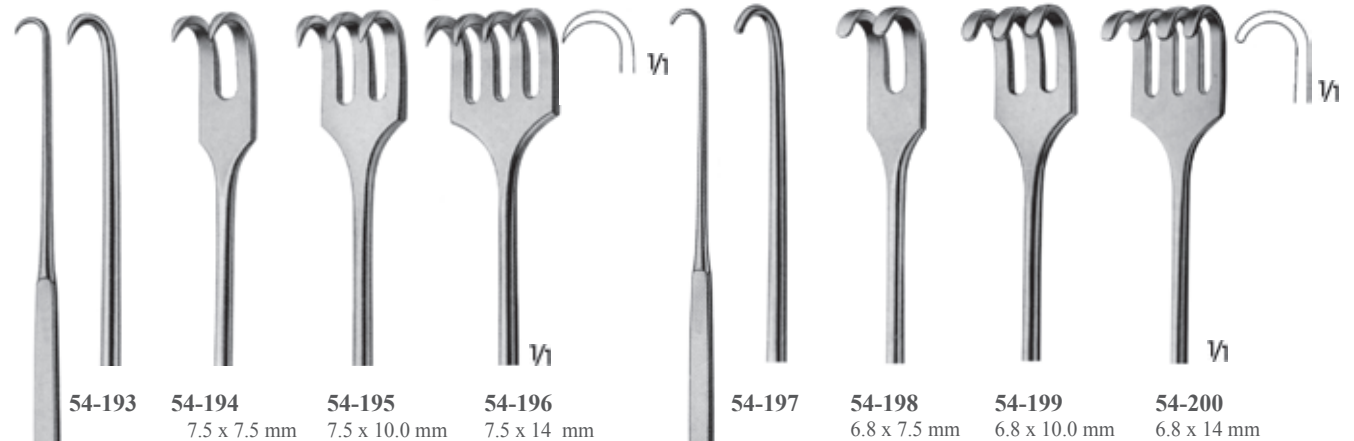
4.5 x 7.0 mm

54-192

4.5 x 9.5 mm

Sivri/Sharp 16.5 cm  
Küçük eğri/Small curve

Künt/Blunt 16.5 cm  
Küçük eğri/Small curve



54-193

54-194

7.5 x 7.5 mm

54-195

7.5 x 10.0 mm

54-196

7.5 x 14 mm

54-197

54-198

6.8 x 7.5 mm

54-199

6.8 x 10.0 mm

54-200

6.8 x 14 mm

Sivri/Sharp 16.5 cm  
Büyük eğri/Large curve

Künt/Blunt 16.5 cm  
Büyük eğri/Large curve



**FOMON**  
**54-201**  
Künt/Blunt  
14.5 cm



**COTTLE**  
**54-202**  
Sağ sivri/Right sharp  
14.5 cm



**Sivri/Sharp**  
16 cm



**54-205**  
16 cm

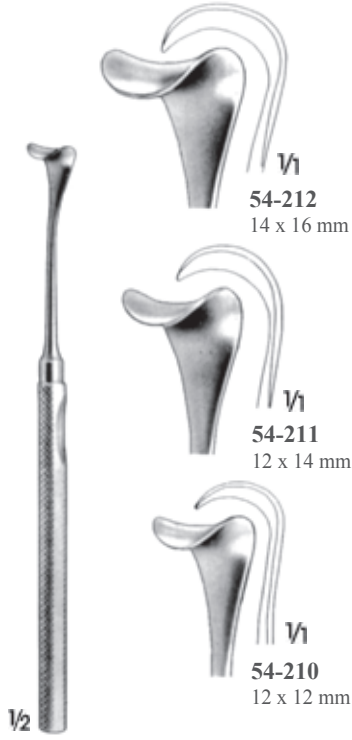


**LANGENBECK-GREEN**  
16 cm



**STRANDELL-STILLE**

Tendon Hukları/Tendon Hooks  
18 cm



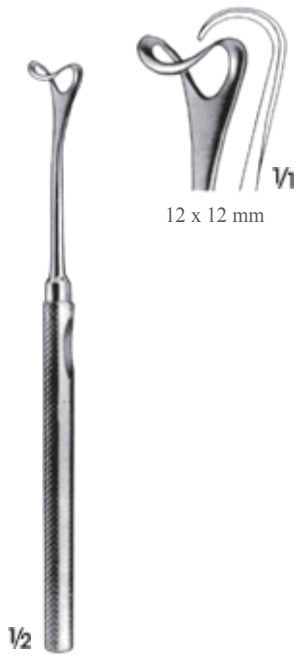
MANNERFELT  
Eyer huklar/Saddle  
hooks 15.5 cm



MANNERFELT  
54-213  
Oluklu/Hollow grooved  
15.5 cm



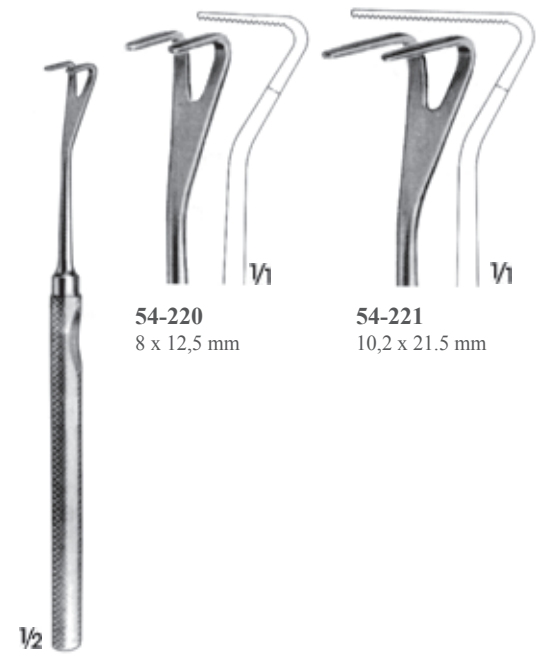
LANGENBECK-MANNERFELT  
15.5 cm



MANNERFELT  
54-218  
Eyer huk, çerçeveseli  
Saddle hook, fenestrated  
15.5 cm

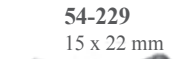
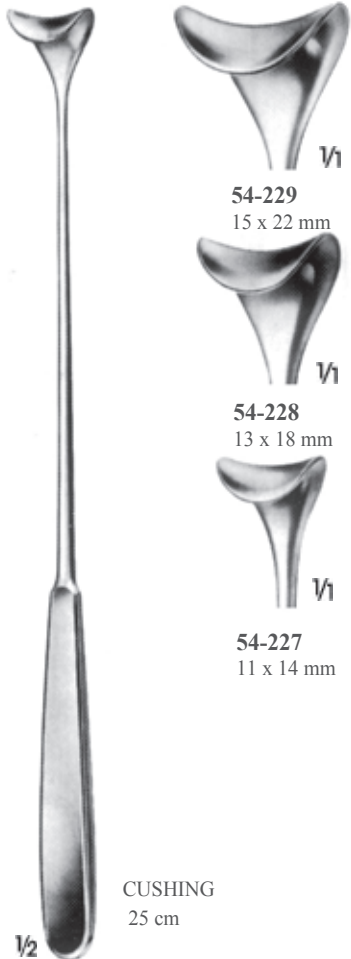
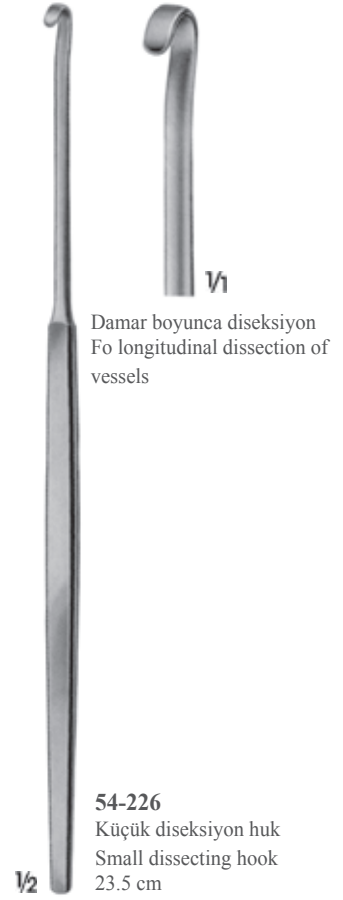
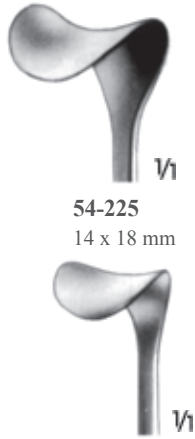


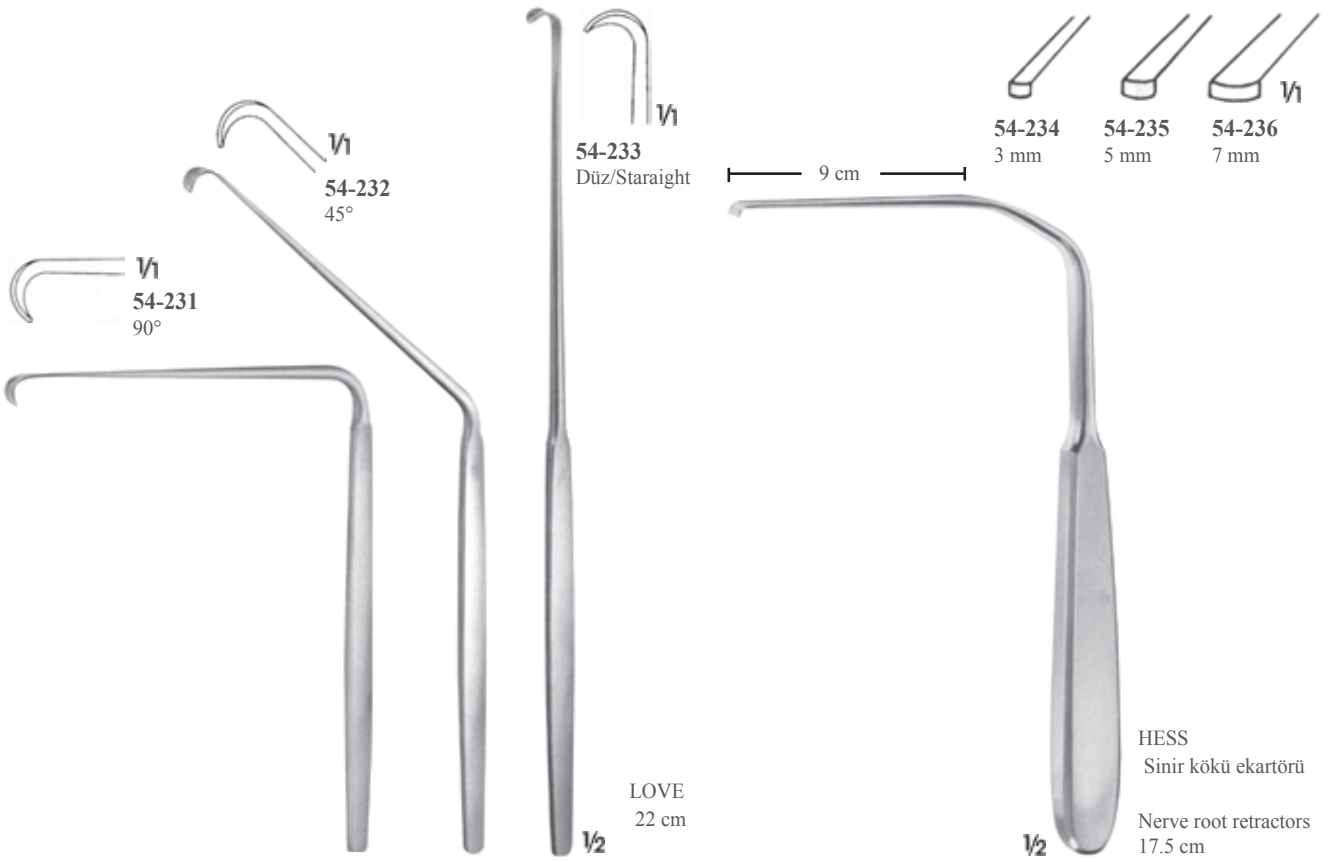
MANNERFELT  
54-219  
Tendon çift uçlu huk  
Tendon double hook  
16 cm

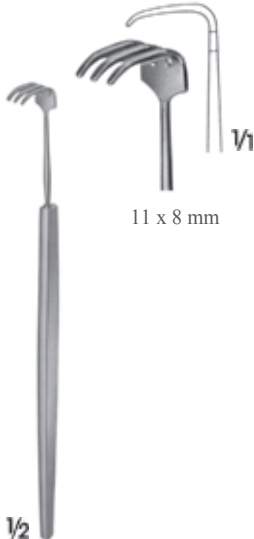


MANNERFELT  
Geri eğimli çatallı huk  
Forked hooks, retrograded  
curved  
15.5 cm

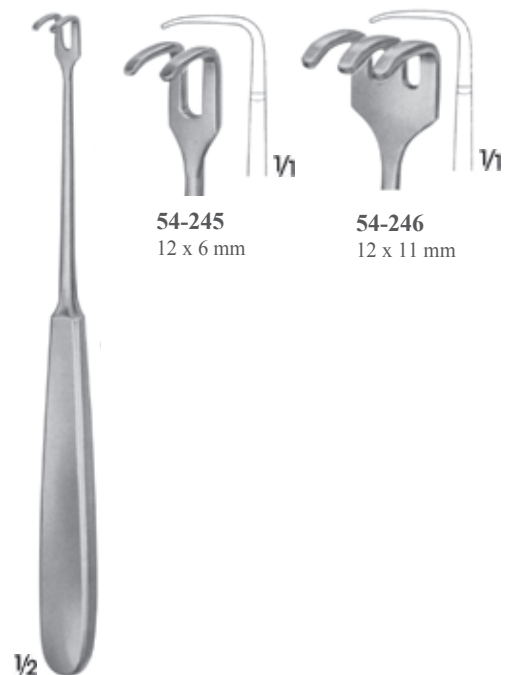








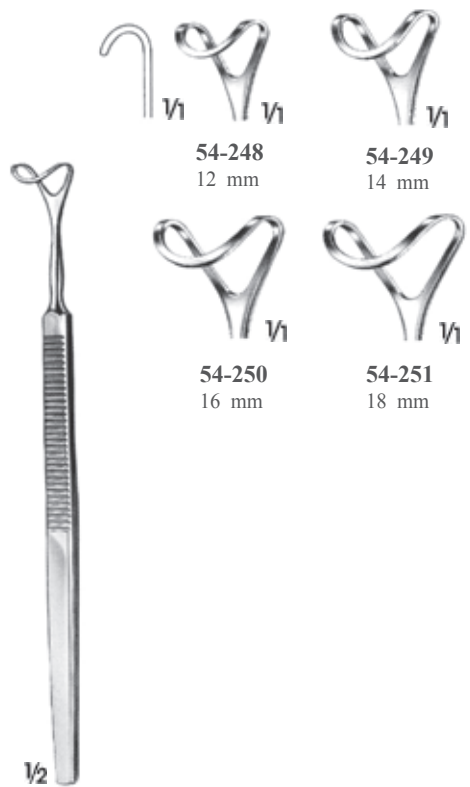
**PAUL**  
**54-244**  
Tendon huk/Tendon hook  
12 cm



17.5 cm  
Tendon hukları/Tendon hooks



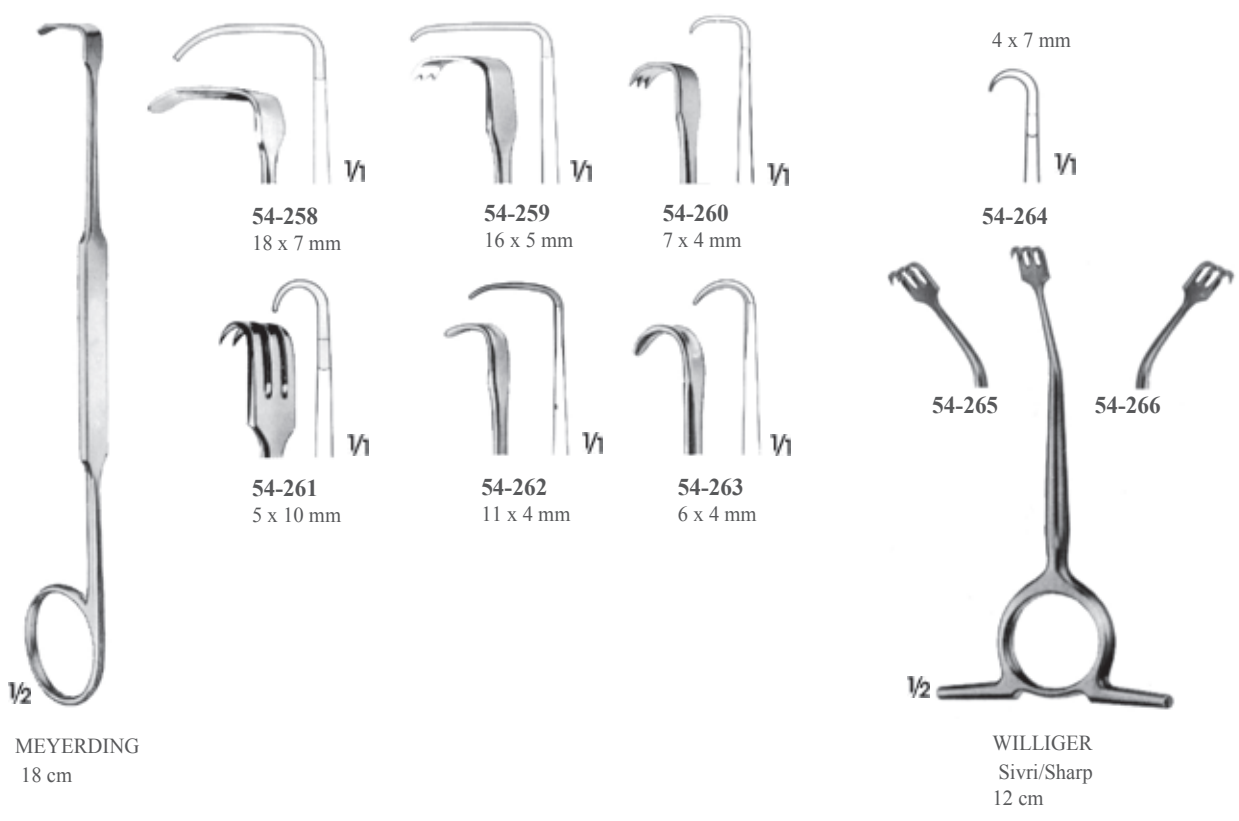
**KLAPP**  
**54-247**  
Tendon huk/Tendon hook  
17.5 cm

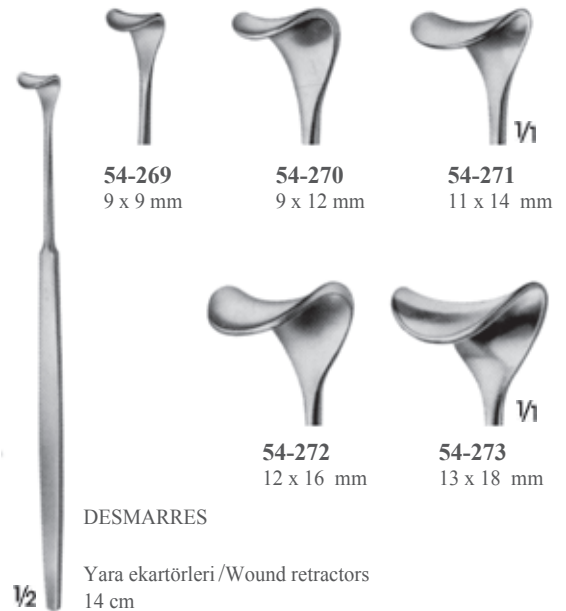
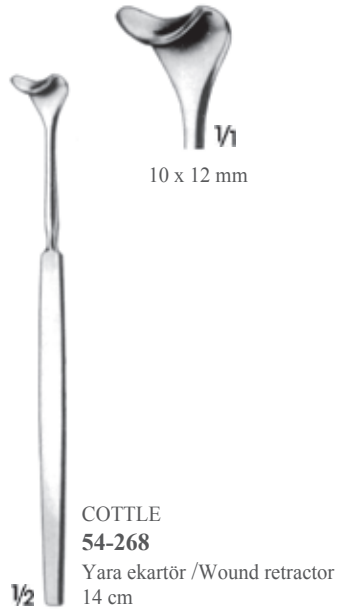
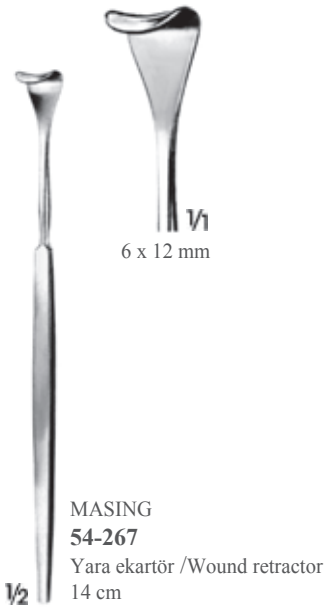


16 cm



**KOCHER**  
20.5 cm







25 x 10 mm  
22 x 10 mm



1/2

28 x 12 mm  
32 x 12 mm

**FARABEUF**  
**54-276**  
12.5 cm

23 x 16 mm  
20 x 16 mm



1/2

24 x 16 mm  
28 x 16 mm

**FARABEUF**  
**54-277**  
15 cm

21 x 14 mm  
17 x 14 mm



1/2

28 x 16 mm  
32 x 16 mm

**COLLIN**  
**54-278**  
15 cm

5 x 3 mm



1/2

14 x 6.3 mm

**RAGNELL**  
**54-279**  
15 cm

10 x 8 mm



1/2

12 x 11 mm

**LUER**  
**54-280**  
11 cm

11 x 4 mm



1/2

19 x 6 mm

**CRILE**  
**54-281**  
11 cm

10 x 12 mm



1/2

11 x 15 mm

**ROSE**  
**54-282**  
13 cm



**ROUX**  
**54-283**  
Komple/Complete  
16.5 cm

19 x 22 mm



**1/2**  
23 x 30 mm  
**54-284**

25 x 26 mm



**1/2**  
28 x 38 mm  
**54-285**

28 x 29 mm



**1/2**  
33 x 45 mm  
**54-286**

30 x 19 mm



**1/2**  
33 x 25 mm  
**KILNER**  
**54-287**  
15 cm

35 x 29 mm



**1/2**  
40 x 35 mm  
**KILNER**  
**54-288**  
15 cm



**1/2**  
**GOELET**  
**54-289**  
19 cm





20 x 22 mm



1/2

25 x 29 mm  
ROUX  
54-290  
15 cm

25 x 26 mm



1/2

30 x 38 mm  
ROUX  
54-291  
16 cm

28 x 29 mm



1/2

33 x 44 mm  
ROUX  
54-292  
17 cm

22 x 15 mm  
18 x 15 mm



1/2

18 x 15 mm  
22 x 15 mm  
PARKER  
54-293  
13.5 cm

17 x 16 mm



1/2

18 x 22 mm  
BABY-ROUX  
54-294  
13.5 cm

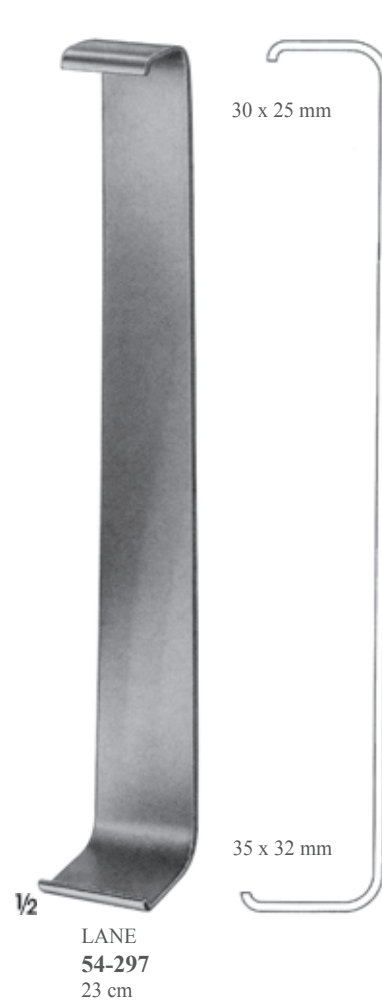
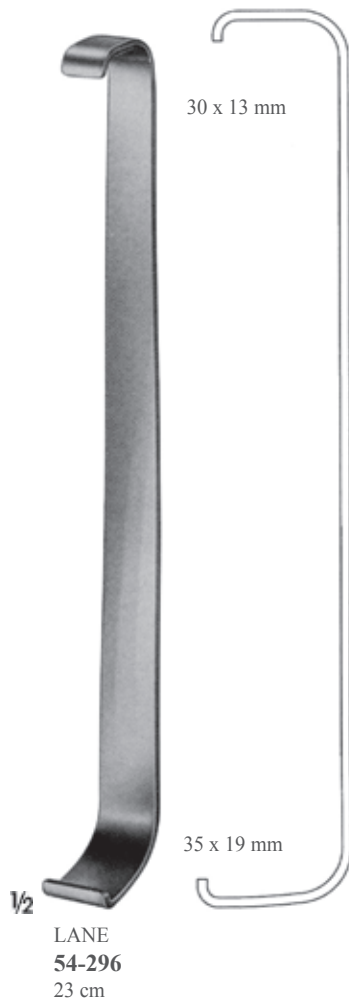
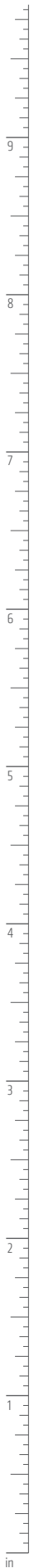
36 x 44 mm  
30 x 24 mm



1/2

36 x 44 mm  
30 x 24 mm  
PARKER  
54-295  
18 cm







26 x 15 mm  
22 x 15 mm

39 x 15 mm  
43 x 15 mm

1/2

US-ARMY  
**54-304**  
22 cm



47 x 13 mm  
41 x 13 mm

37 x 25 mm  
45 x 25 mm

1/2

MATHIEU  
**54-305**  
20 cm

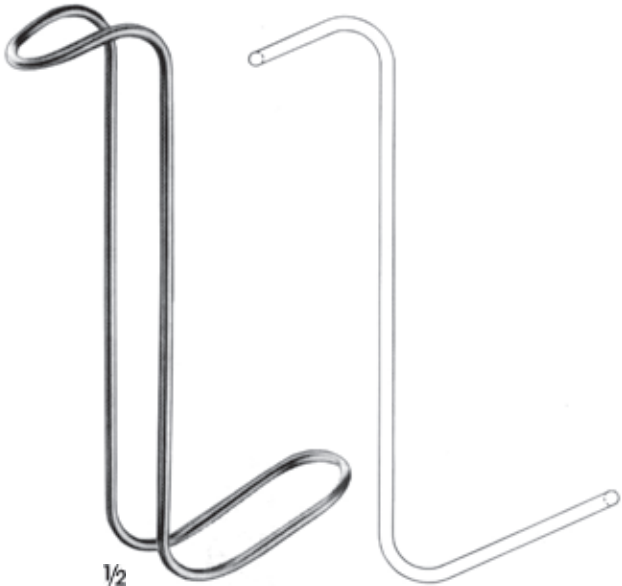


38 x 22 mm

38 x 22 mm

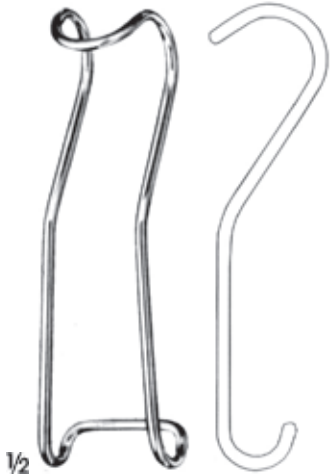
1/2

CZERNY  
**54-306**  
17.5 cm



1/2

COLLIN-HARTMANN  
**54-307**  
15 cm



1/2

STERNBERG  
**54-307** 12 cm  
**54-308** 13 cm  
**54-309** 13.5 cm





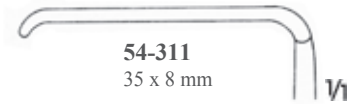
KOCHER-LANGENBECK  
21.5 cm

1/2



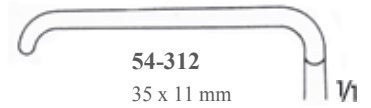
54-310  
25 x 6 mm

1/1



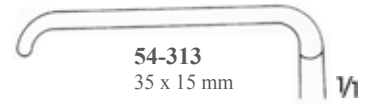
54-311  
35 x 8 mm

1/1



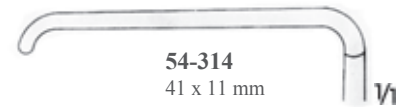
54-312  
35 x 11 mm

1/1



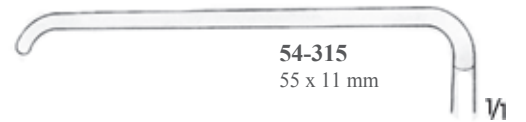
54-313  
35 x 15 mm

1/1



54-314  
41 x 11 mm

1/1



54-315  
55 x 11 mm

1/1



54-316  
70 x 14 mm

1/1



54-317  
80 x 12 mm

1/1



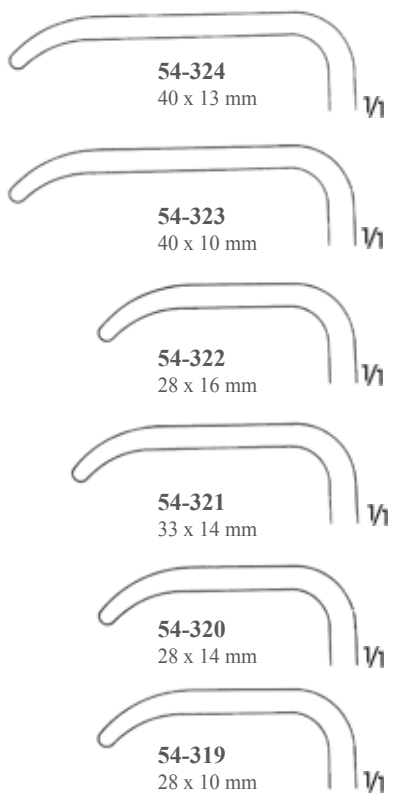
54-318  
80 x 16 mm

1/1



1/2

LANGENBECK  
21 cm

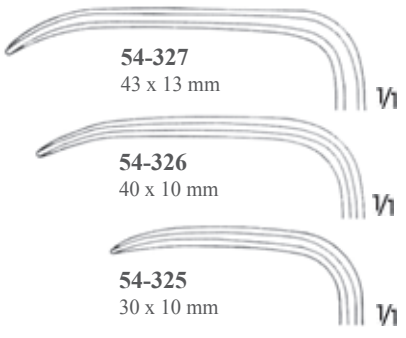


- 54-324  
40 x 13 mm
- 54-323  
40 x 10 mm
- 54-322  
28 x 16 mm
- 54-321  
33 x 14 mm
- 54-320  
28 x 14 mm
- 54-319  
28 x 10 mm



1/2

LANGENBECK  
23 cm



- 54-327  
43 x 13 mm
- 54-326  
40 x 10 mm
- 54-325  
30 x 10 mm



1/2

MURPHY  
19.5 cm



54-328  
Sivri/Sharp



54-329  
Sivri/Sharp



54-330  
Künt/Blunt



54-331  
Künt/Blunt





KOCHER  
54-332  
Sivri/Sharp  
20.5 cm



KOCHER  
54-333  
Sivri/Sharp  
22 cm



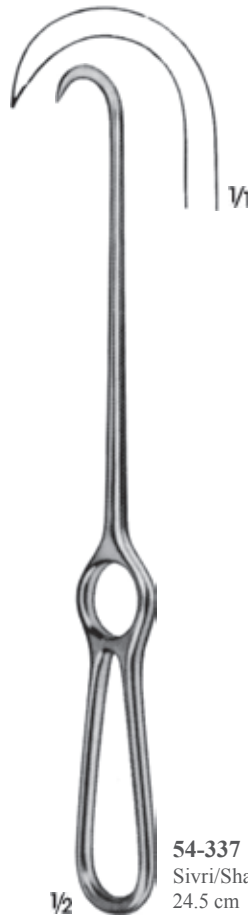
KOCHER  
54-334  
Künt/Blunt  
22 cm



VOLKMANN  
54-335  
Sivri/Sharp  
22 cm



VOLKMANN  
54-336  
Künt/Blunt  
22 cm

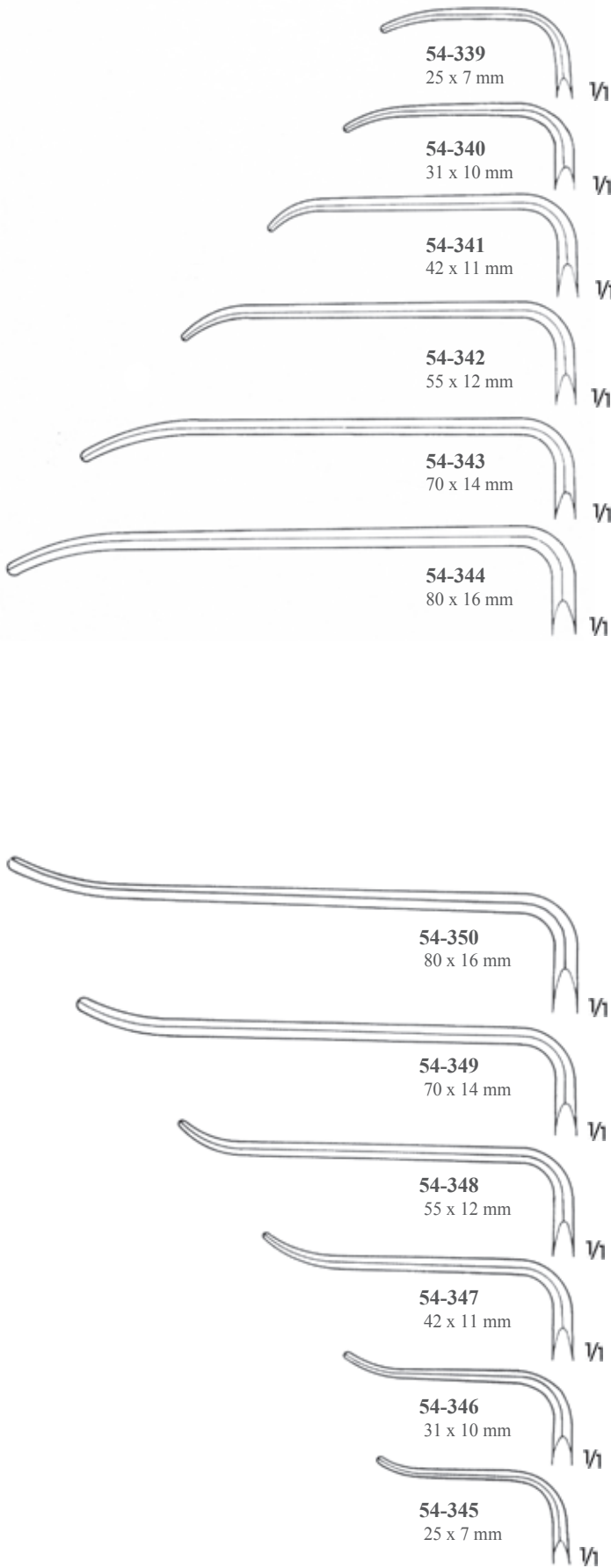


54-337  
Sivri/Sharp  
24.5 cm



VOLKMANN  
54-338  
Sivri/Sharp  
22 cm





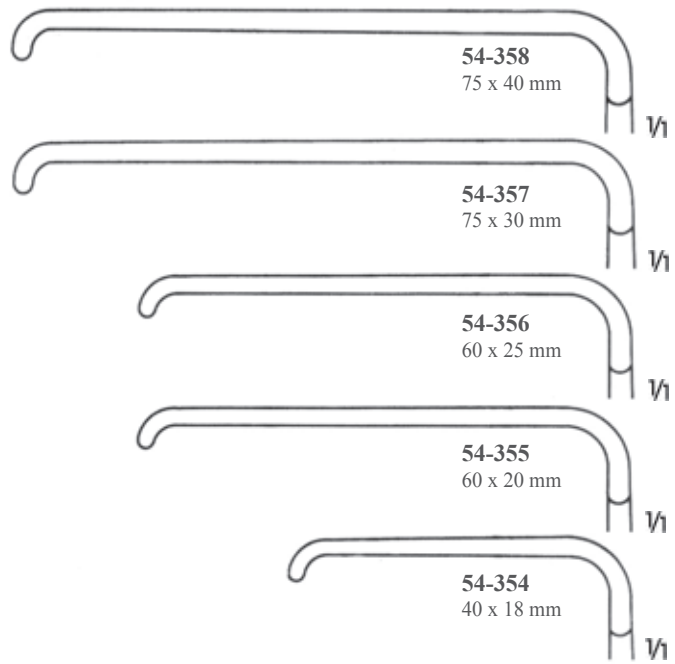
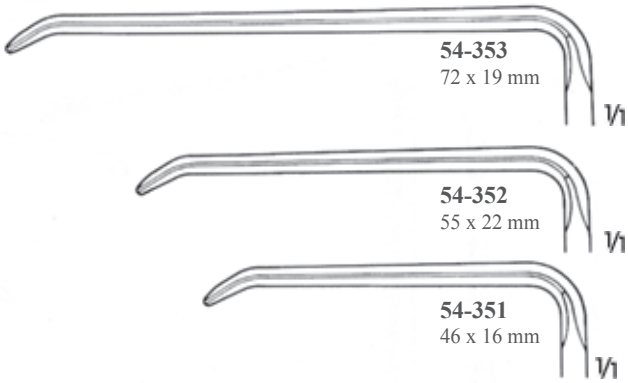
OBWEGESER  
21.5 cm

1/2



OBWEGESER  
21.5 cm

1/2





VOLKMANN  
22 cm

Sivri  
Sharp



54-359  
9 x 8 mm



54-360  
9 x 13 mm



54-361  
9 x 19 mm



54-362  
9 x 29 mm



54-363  
9 x 40 mm

Künt  
Blunt



54-364  
8 x 8 mm



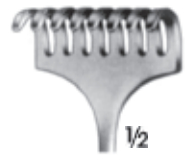
54-365  
8 x 13 mm



54-366  
8 x 19 mm



54-367  
8 x 29 mm



54-368  
8 x 40 mm

Yarı sivri  
Semi-sharp



54-369  
8.5 x 8 mm



54-370  
8.5 x 13 mm



54-371  
8.5 x 19 mm



54-372  
8.5 x 29 mm



54-373  
8.5 x 40 mm



VOLKMANN  
22.5 cm

Sivri  
Sharp



54-374  
9 x 8 mm



54-375  
9 x 13 mm



54-376  
9 x 19 mm



54-377  
9 x 29 mm

Künt  
Blunt



54-378  
8.5 x 8 mm



54-379  
8.5 x 13 mm



54-380  
8.5 x 19 mm



54-381  
8.5 x 29 mm





1/2

**KOCHER**  
22 cm

Yarı sivri  
Semi-sharp

Künt  
Blunt



1/1



**54-382**  
16 x 9 mm



**54-383**  
16 x 14 mm



**54-384**  
16 x 20 mm



**54-385**  
16 x 30 mm

1/2



**54-386**  
15.5 x 9 mm



**54-387**  
15.5 x 14 mm



**54-388**  
15.5 x 20 mm



**54-389**  
15.5 x 30 mm

1/2



1/2

**KÖRTE**

Dikey saplı bleyd  
Handle vertical to the blade  
24 cm



26 x 40 mm

1/2

**54-390**  
8 dişli, yarı sivri  
8 prongs, semi-sharp



26 x 40 mm

1/2

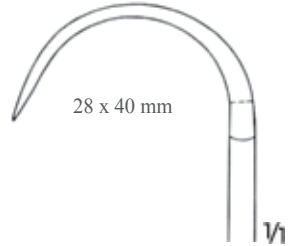
**54-391**  
8 dişli, künt  
8 prongs, blunt



1/2

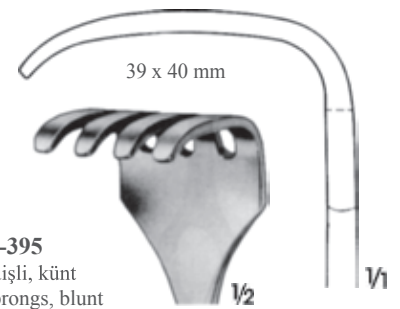
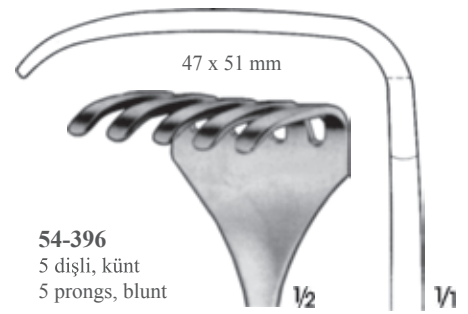
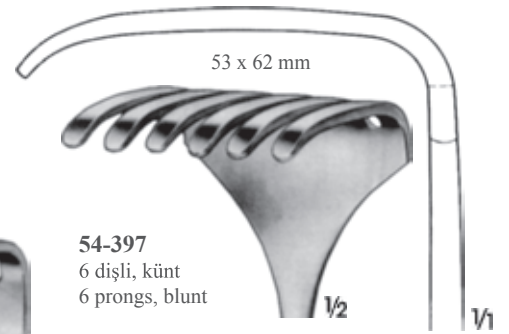
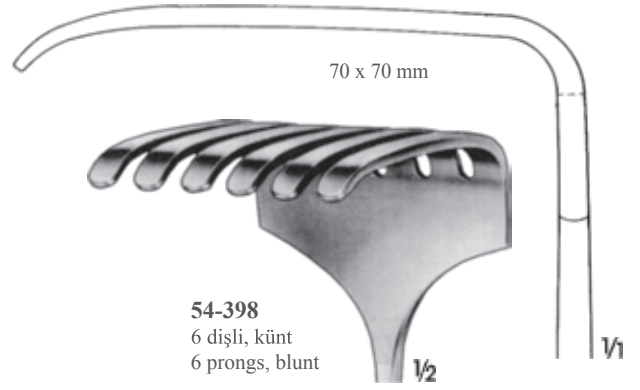
**KÖRTE-WAGNER**

**54-392**  
8 dişli, yarı sivri  
8 prongs, semi sharp  
28 cm



28 x 40 mm

1/1

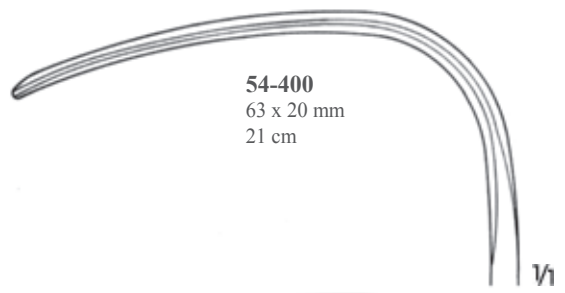


**ISRAEL**  
25.5 cm

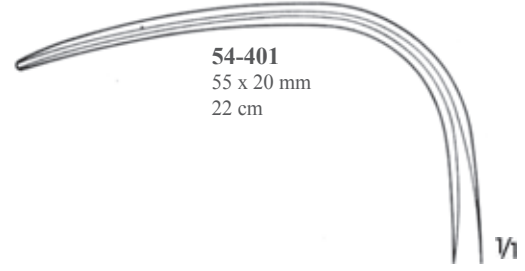




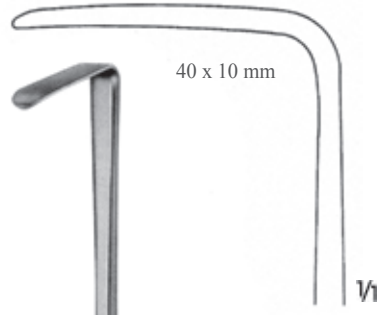
**54-399**  
21 cm



**54-400**  
63 x 20 mm  
21 cm



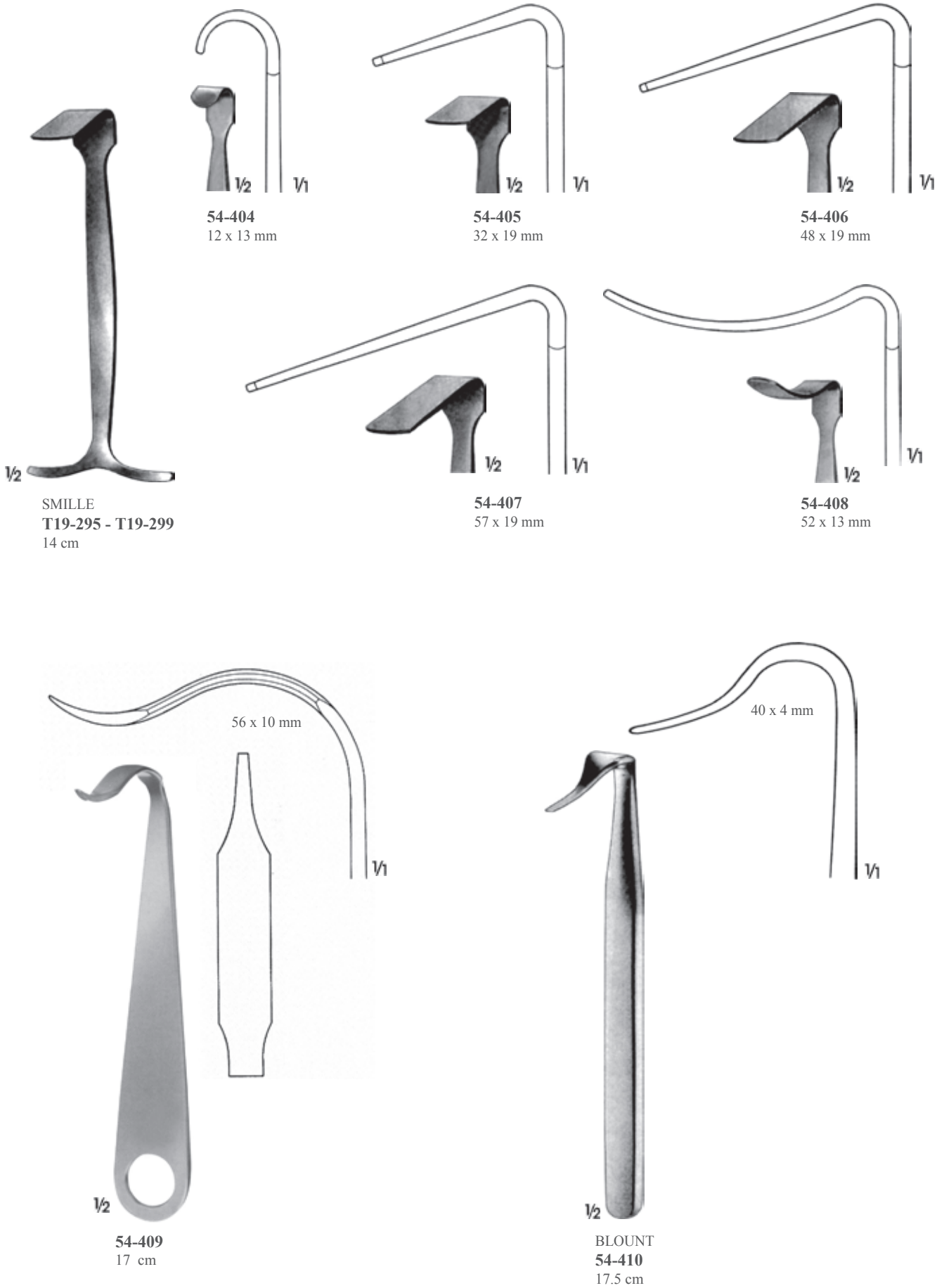
**54-401**  
55 x 20 mm  
22 cm



**54-402**  
21.5 cm



**LANGENBECK**  
**54-403**  
Dikey saplı bleyd  
Handle vertical to the blade  
21.5 cm





**54-411**  
53 x 15 mm  
22.5 cm

**54-412**  
59 x 20 mm  
21.5 cm

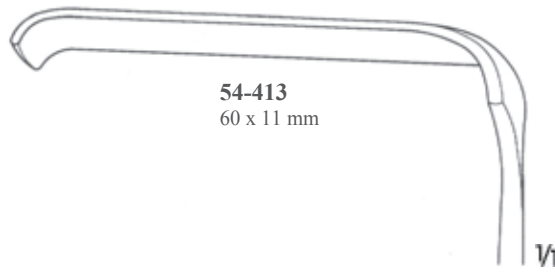
SCHULZ

Emiş tertibatlı ekartör, ufak ameliyatlarda ve tek elle kullanılır.  
Retractor with suction device, for one-handed operation in minor surgery.



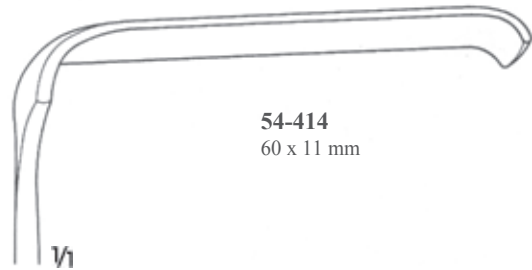
KIRSCH  
21 cm

1/2



**54-413**  
60 x 11 mm

1/1



**54-414**  
60 x 11 mm

1/1



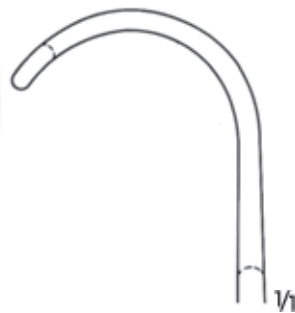
MIDDELDORPF



54-415  
15 x 15 mm  
22 cm



54-416  
20 x 22 mm  
21.5 cm



54-417  
28 x 28 mm  
23.5 cm



GREENE  
54-418  
22.5 cm



22 x 22 mm



DURHAM  
54-419  
21.5 cm



16 x 25 mm





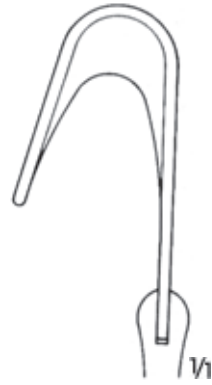
1/2  
54-420  
20.5 cm



18 x 35 mm



1/2



1/1



1/1  
24 x 8 mm

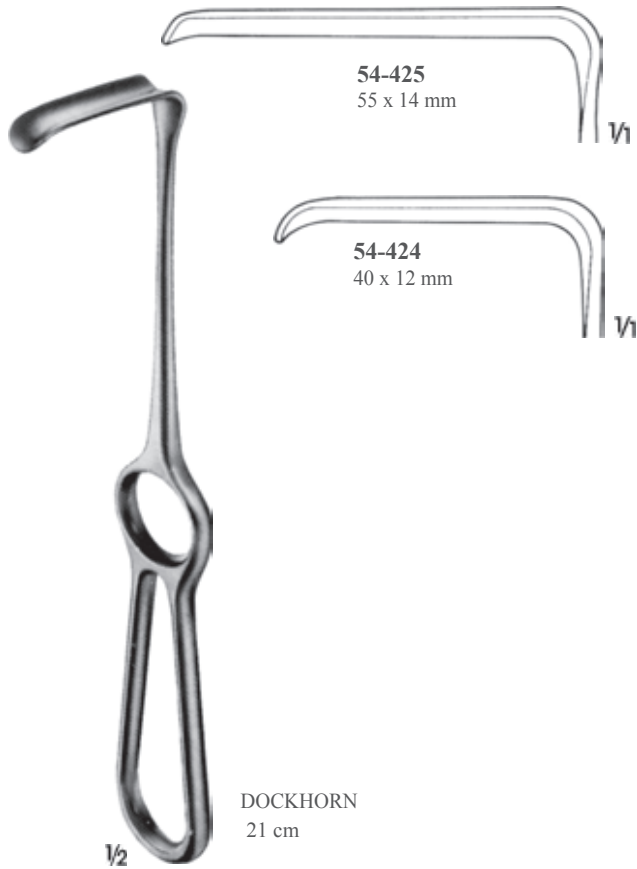


38 x 9 mm

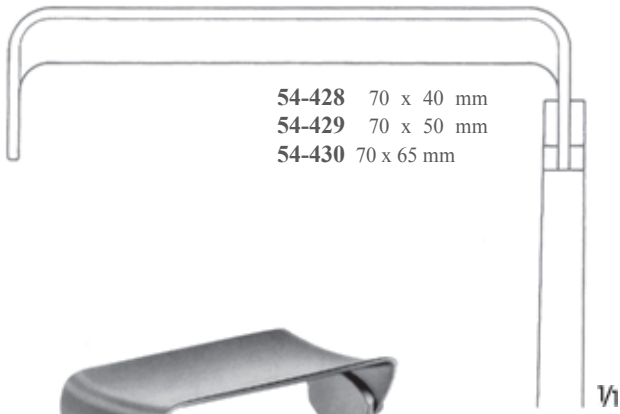
1/1

1/2  
LAHEY  
54-421  
20 cm

1/2  
54-422  
22.5 cm







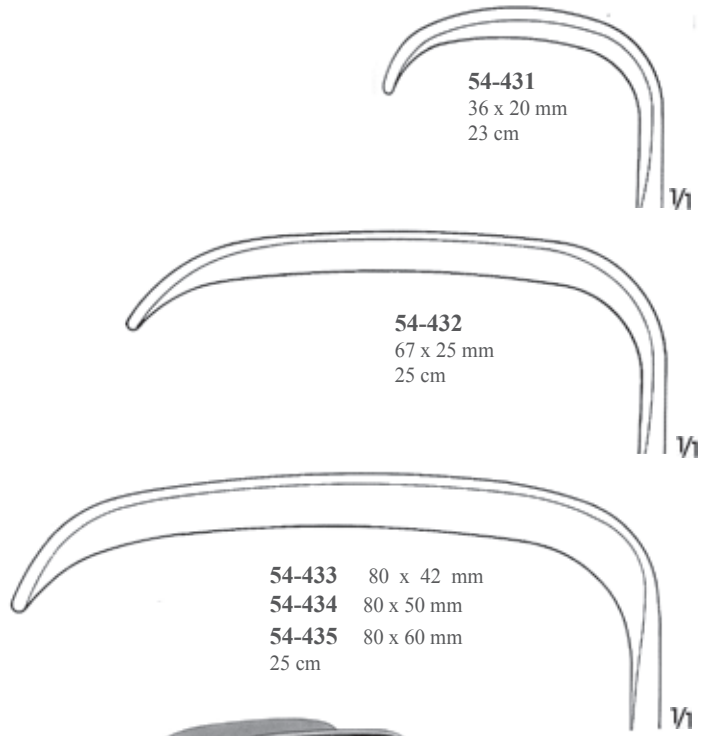
**54-428** 70 x 40 mm  
**54-429** 70 x 50 mm  
**54-430** 70 x 65 mm

V1



**MORRIS**  
24.5 cm

V2



**54-431**  
36 x 20 mm  
23 cm

**54-432**  
67 x 25 mm  
25 cm

**54-433** 80 x 42 mm  
**54-434** 80 x 50 mm  
**54-435** 80 x 60 mm  
25 cm

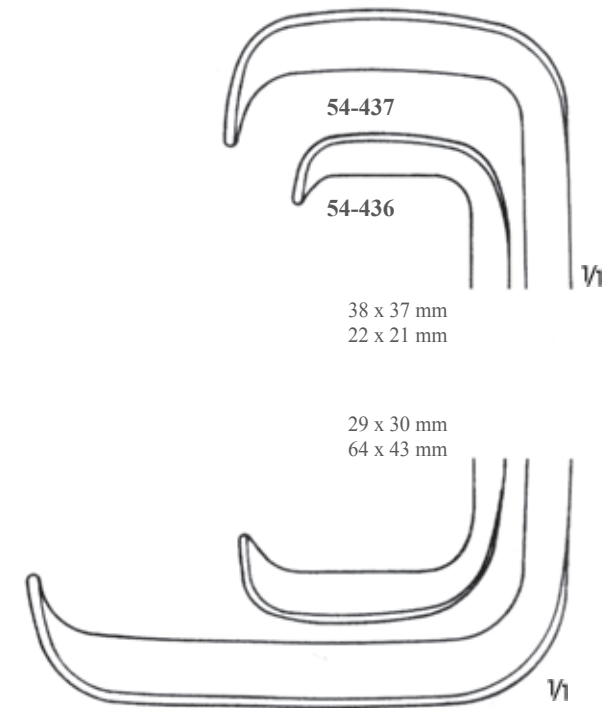
V1

V1

V1



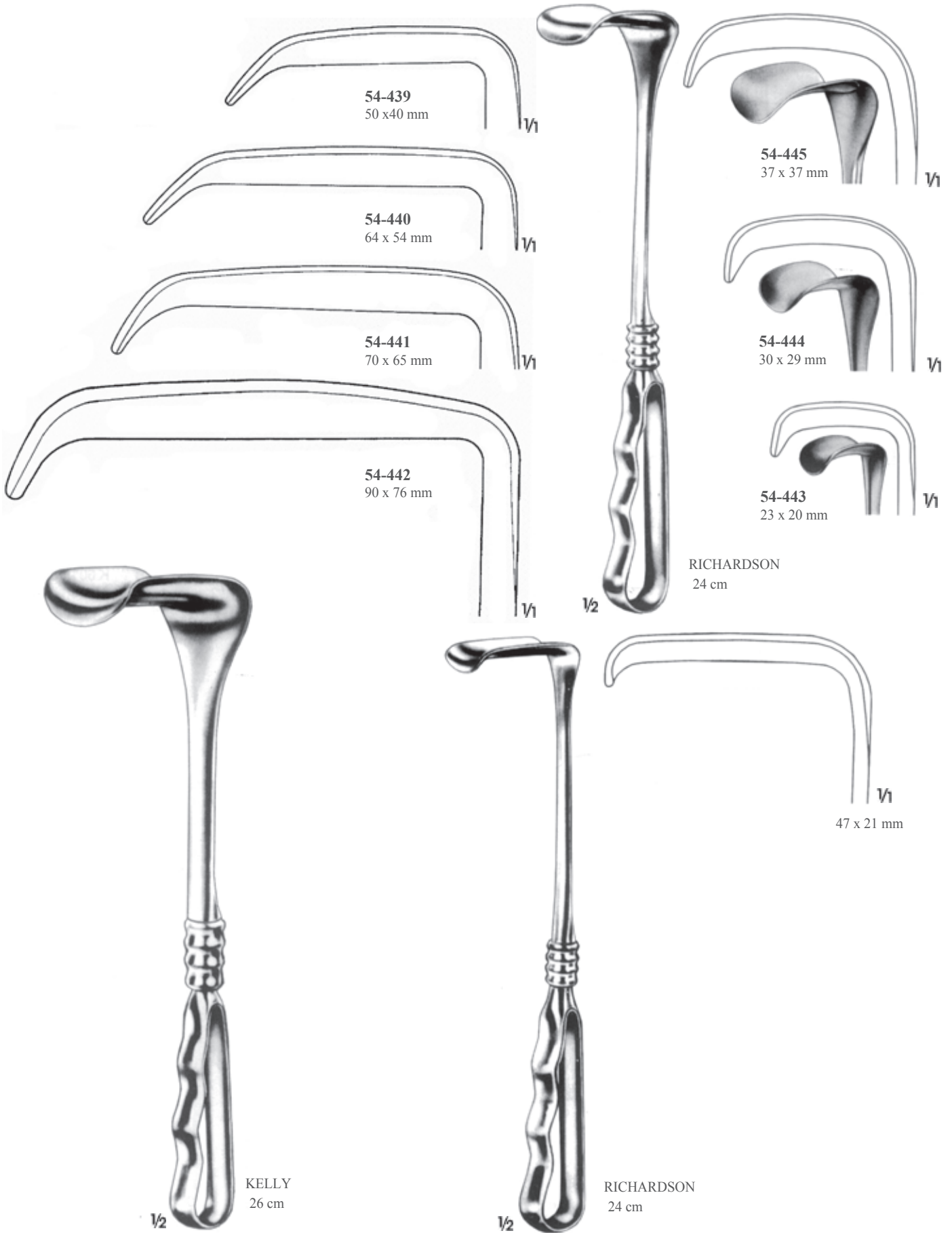
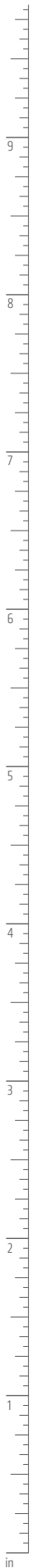
**KOCHER**

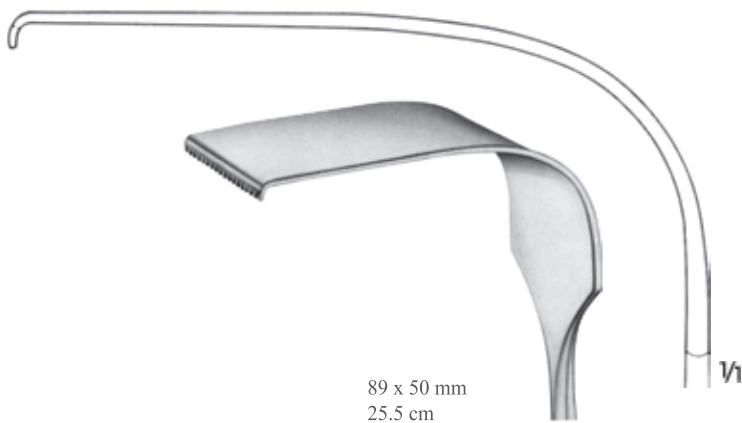


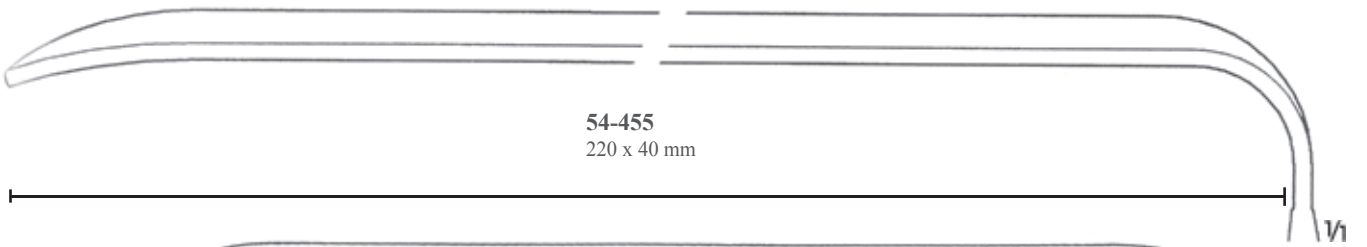
RICHARDSON  
54-438  
25 cm

V2

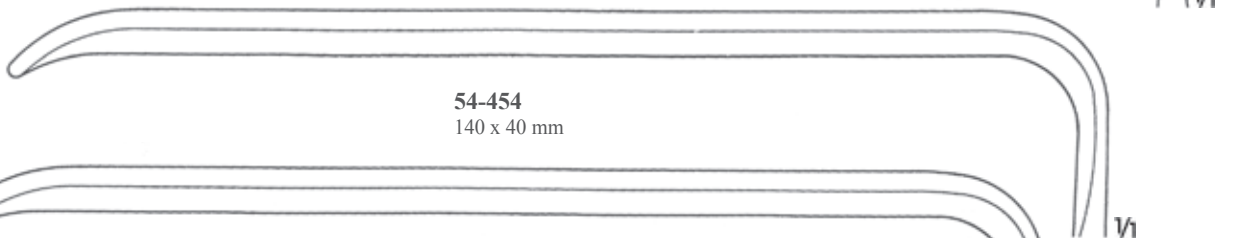




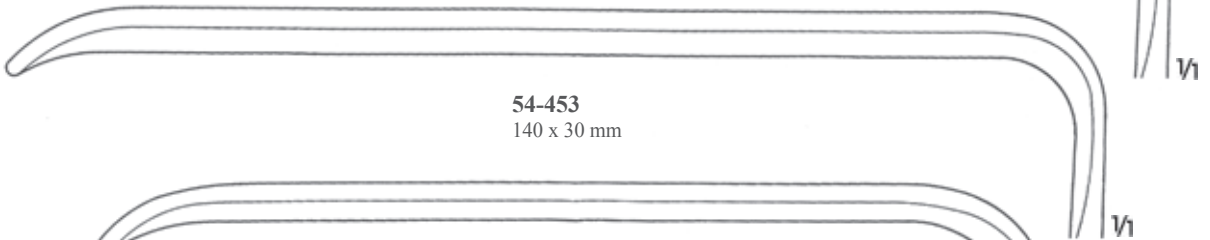




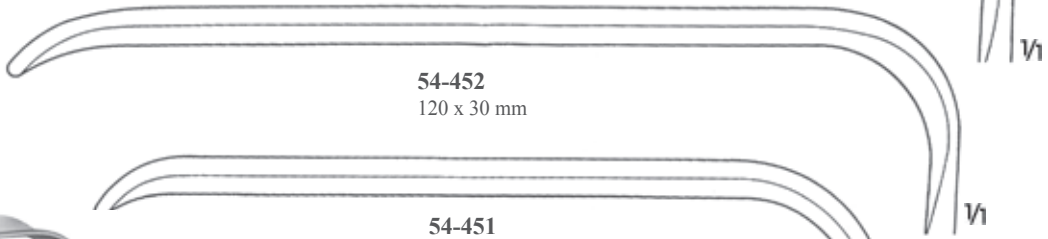
54-455  
220 x 40 mm



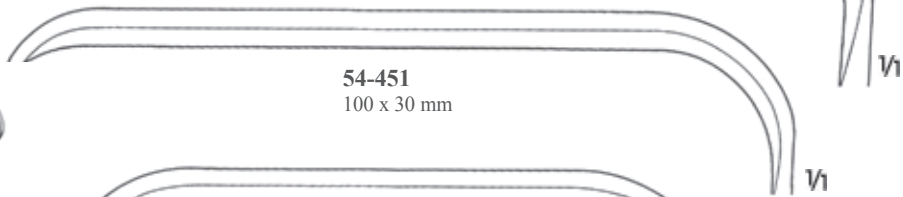
54-454  
140 x 40 mm



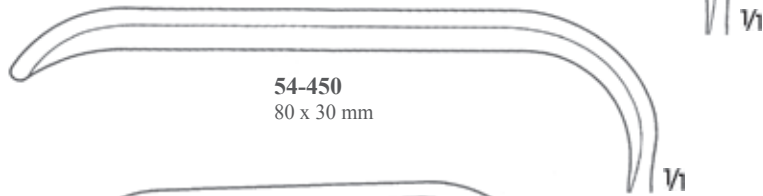
54-453  
140 x 30 mm



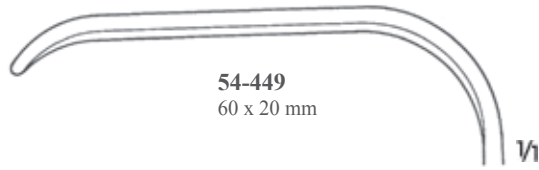
54-452  
120 x 30 mm



54-451  
100 x 30 mm



54-450  
80 x 30 mm



54-449  
60 x 20 mm



HÖSEL  
25 cm





54-463  
94 x 36 mm

54-462  
64 x 25 mm

54-461  
36 x 20 mm

54-460  
20 x 15 mm

$\frac{1}{2}$   
KOCHER-WAGNER  
28 cm



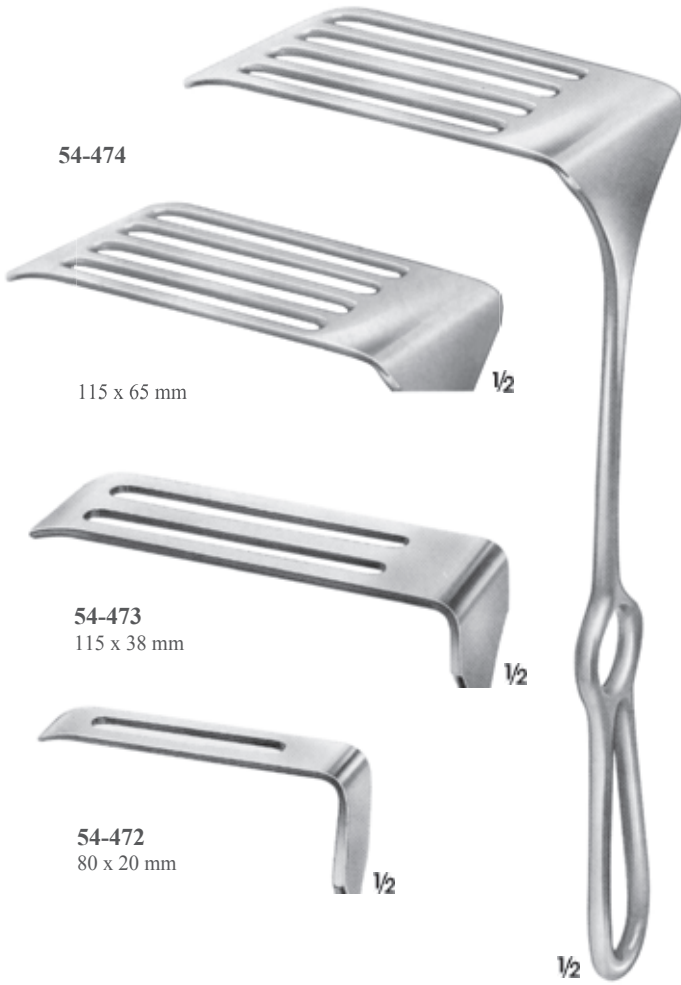
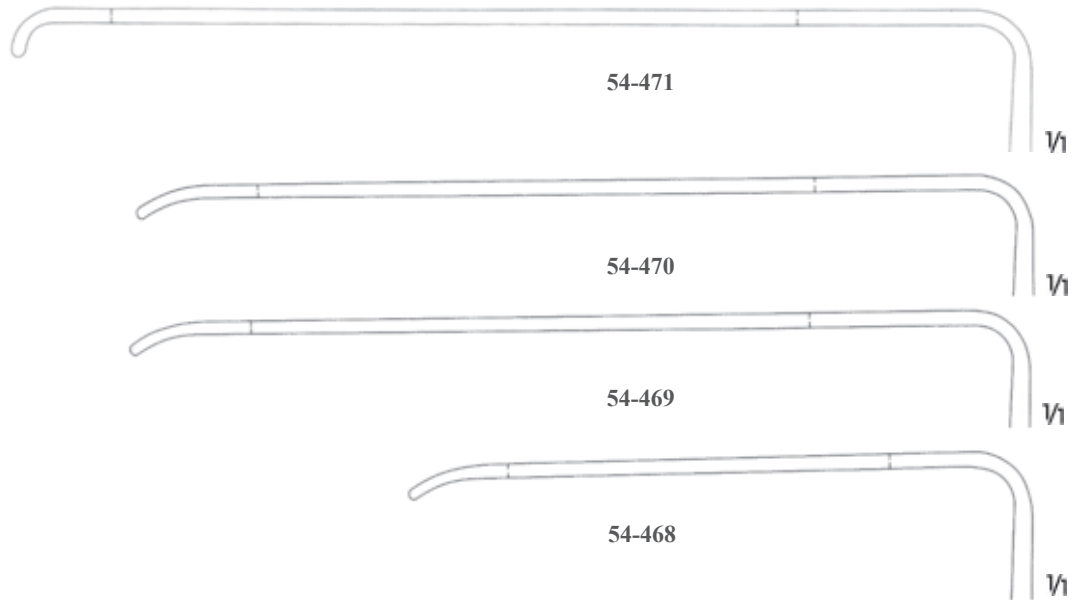
**1/2**  
ZENKER  
54-464  
24 cm

**1/2**  
ZENKER  
54-465  
25.5 cm

**1/2**  
ZENKER  
54-466  
27 cm

**1/2**  
ZENKER  
54-467  
29 cm





54-474

115 x 65 mm

54-473

115 x 38 mm

54-472

80 x 20 mm

54-471

54-470

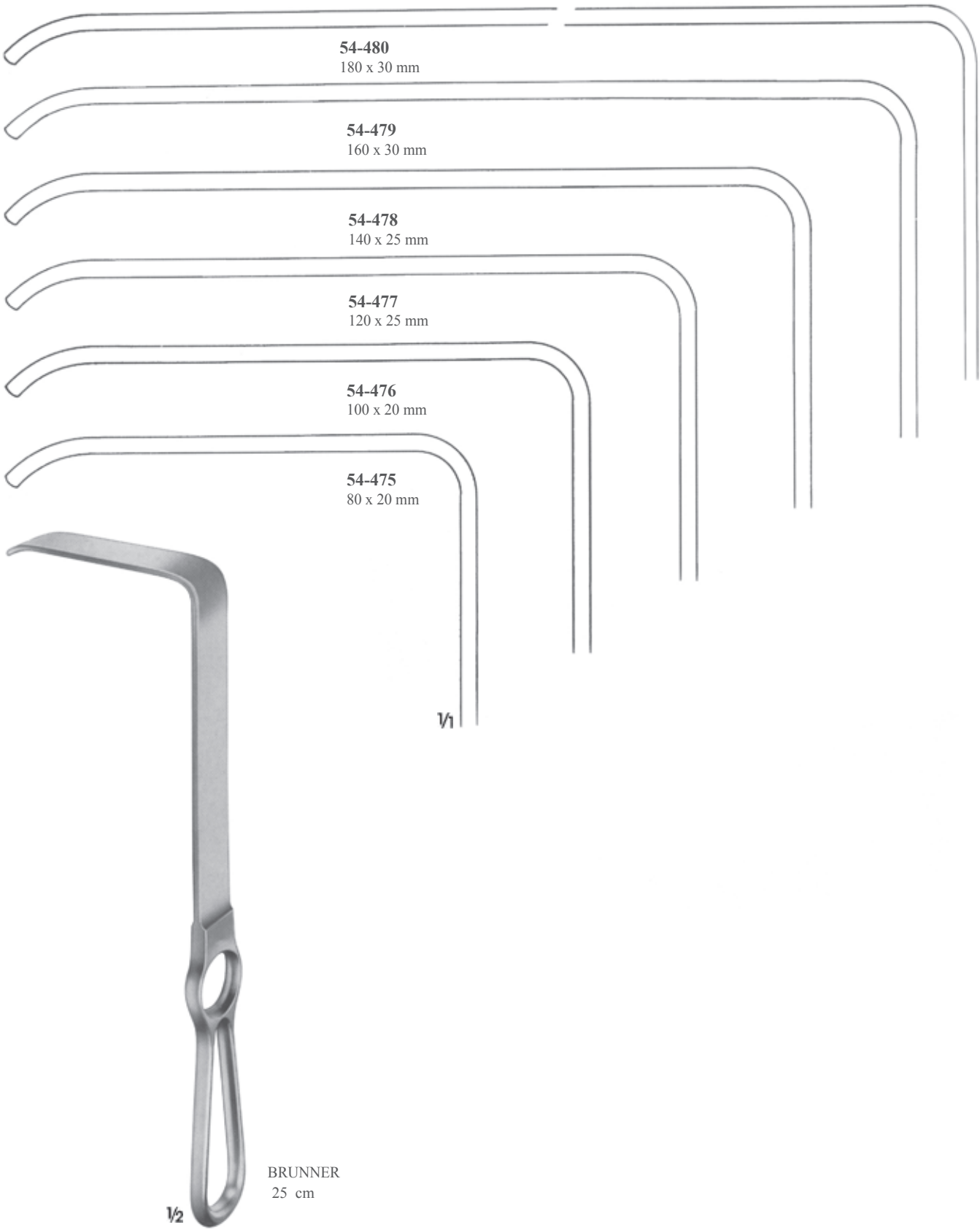
54-469

54-468

130 x 38 mm

CORYLLOS  
25.5 cm

SAUERBRUCH  
26 cm



**54-480**  
180 x 30 mm

**54-479**  
160 x 30 mm

**54-478**  
140 x 25 mm

**54-477**  
120 x 25 mm

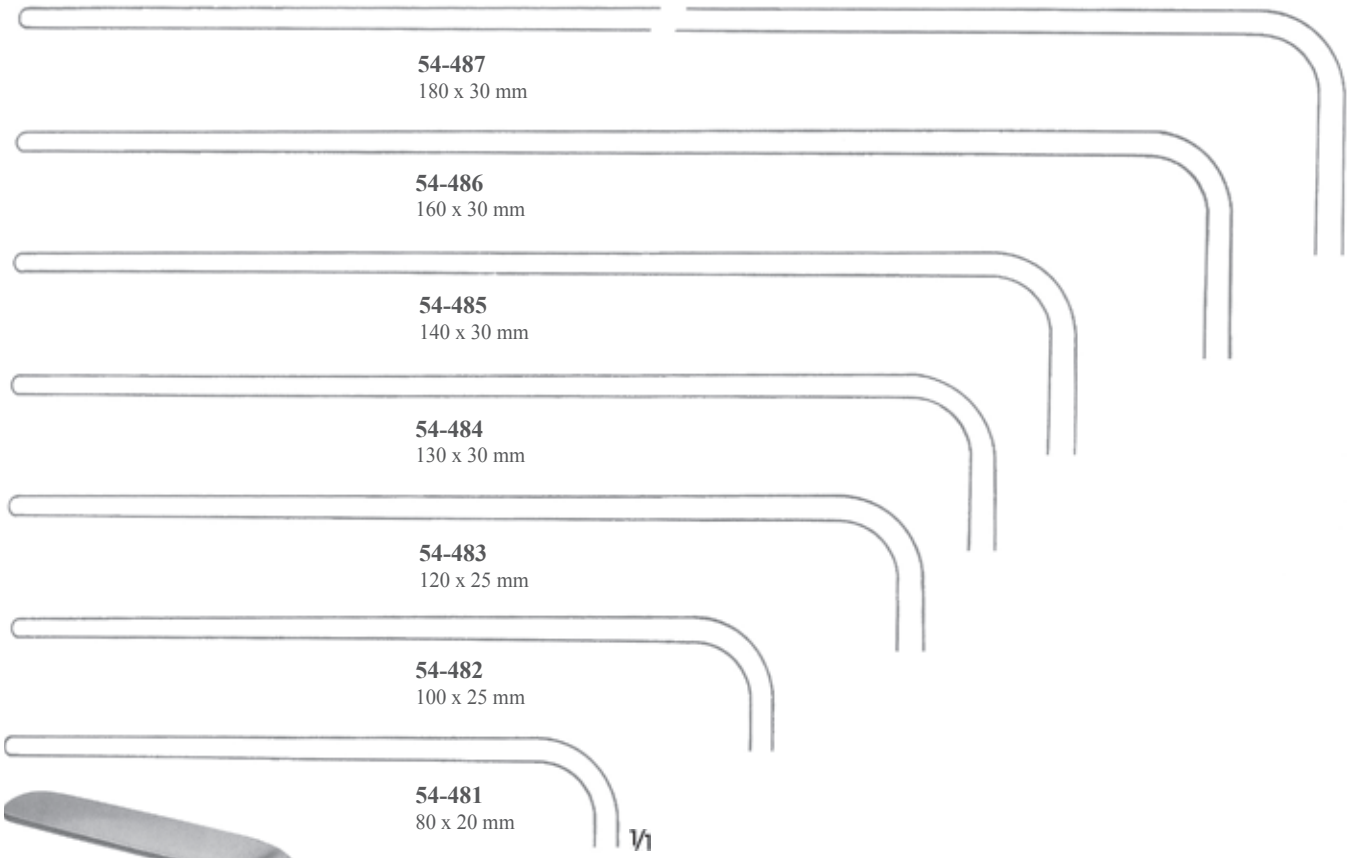
**54-476**  
100 x 20 mm

**54-475**  
80 x 20 mm

**BRUNNER**  
25 cm

1/2





**54-487**  
180 x 30 mm

**54-486**  
160 x 30 mm

**54-485**  
140 x 30 mm

**54-484**  
130 x 30 mm

**54-483**  
120 x 25 mm

**54-482**  
100 x 25 mm

**54-481**  
80 x 20 mm

**V1**



**V2**

**BRUNNER**  
27.5 cm



DEAVER  
54-488  
30 cm



DEAVER  
54-489  
31.5 cm



75 mm

1/2

DEAVER  
54-490  
32 cm



25 mm

1/2

DEAVER  
54-491  
36.5 cm



38 mm

1/2

DEAYER  
54-492  
30 cm



50 mm

1/2

DEAYER  
54-493  
31 cm





DEAVER  
54-494  
31 cm



DEAVER  
54-495  
31 cm



LERICHE  
54-496  
25.5 cm



LERICHE  
54-497  
27.5 cm







50 mm

1/2

DEAVER  
54-498  
30.5 cm



75 mm

1/2

DEAVER  
54-499  
31 cm



1/2

**54-500**  
Üretral ekartör  
Urethral retractor  
39 cm



1/2

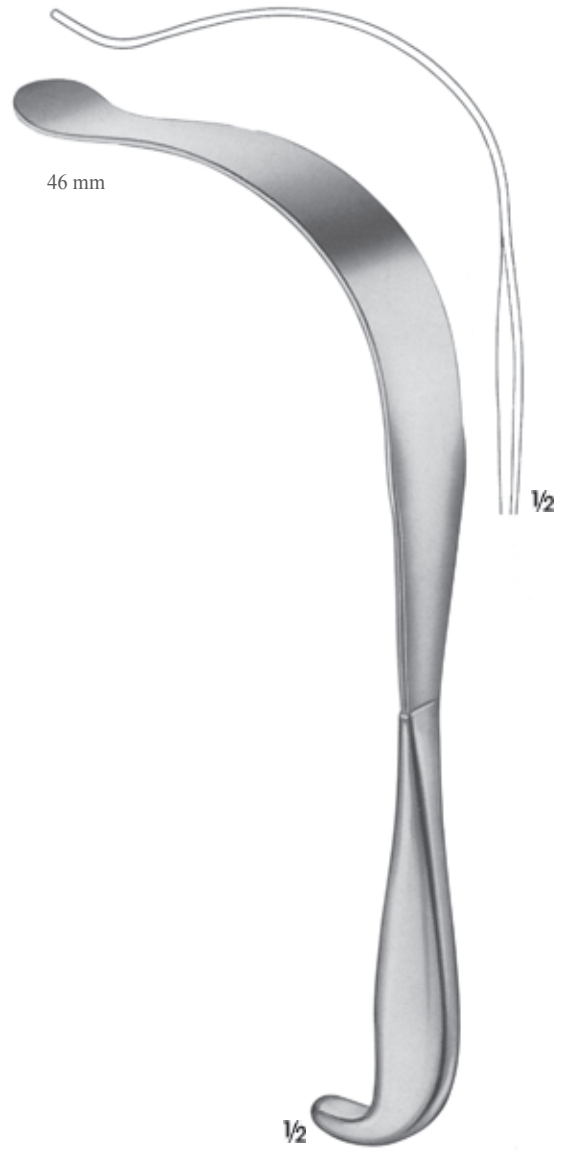
**54-501**  
Prostat ekartör  
Prostate retractor  
36 cm





1/2

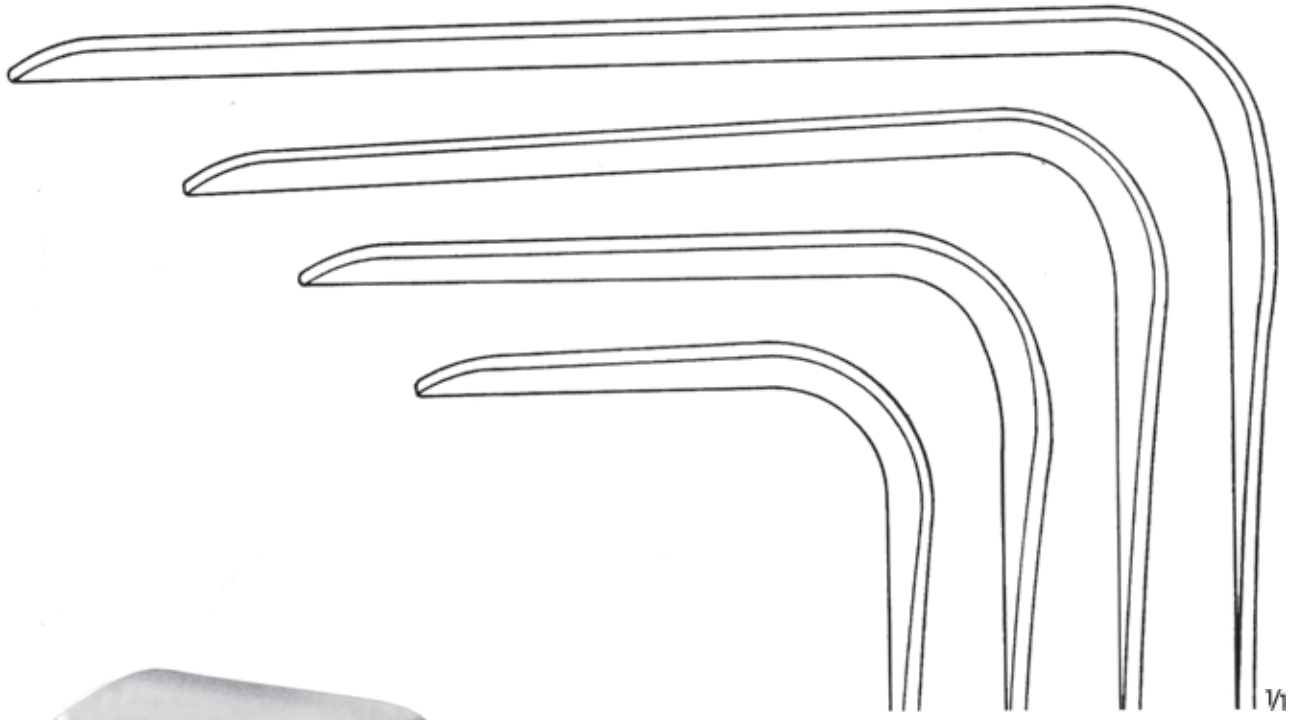
KÖRTE  
54-502  
30 cm



1/2

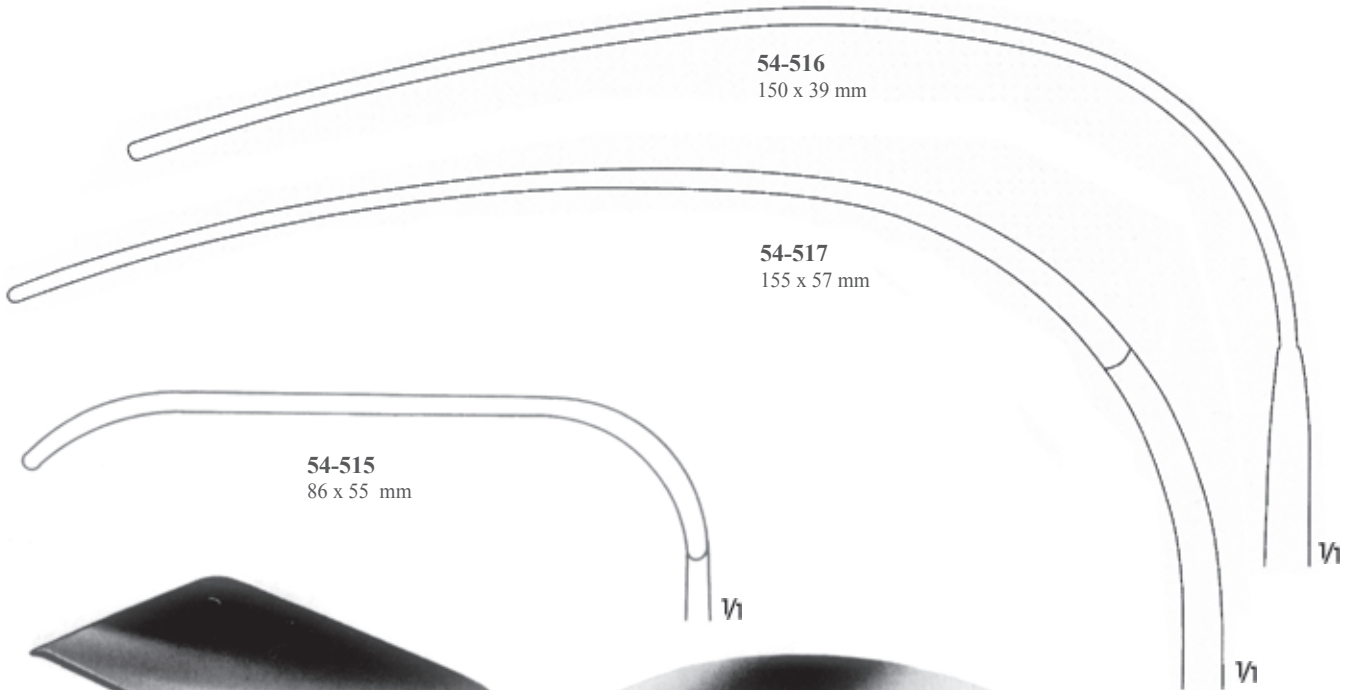
1/2

KÜMMEL  
54-503  
Bükülebilir/Malleable  
28.5 cm



DOYEN  
24 cm

Ağız uzunlukları Length of blades	Ağız genişlikleri Width of blades		
60 mm	35 mm <b>54-504</b>	45 mm <b>54-507</b>	60 mm <b>54-511</b>
90 mm	<b>54-505</b>	<b>54-508</b>	<b>54-512</b>
120 mm	<b>54-506</b>	<b>54-509</b>	<b>54-513</b>
160 mm		<b>54-510</b>	<b>54-514</b>

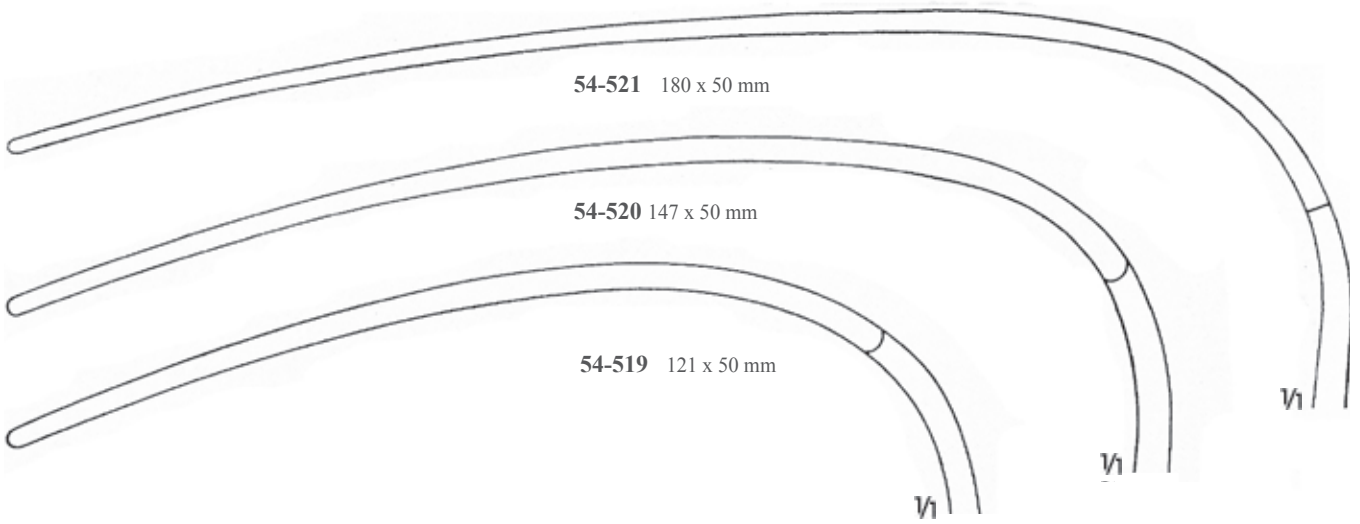


**1/2**  
MIKULICZ  
25.5 cm



**1/2**  
KELLY  
26 cm

Derin Cerrahi Ekartörler (Batın Ekartörleri)  
Retractors for Deep Surgery (Abdominal Retractors)



$\frac{1}{2}$   
MIKULICZ  
24 cm

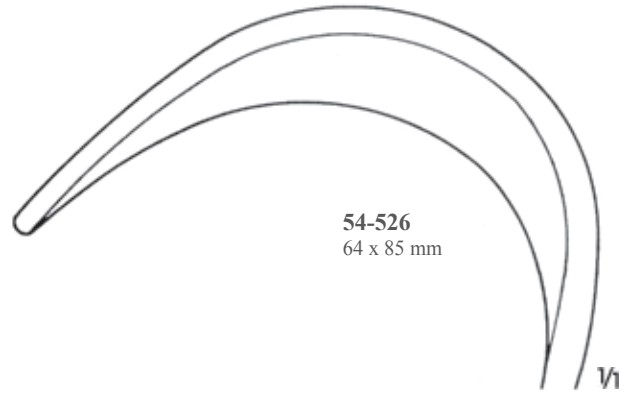


$\frac{1}{2}$   
MIKULICZ  
54-519 - 54-520  
25 cm  
54-521  
26 cm



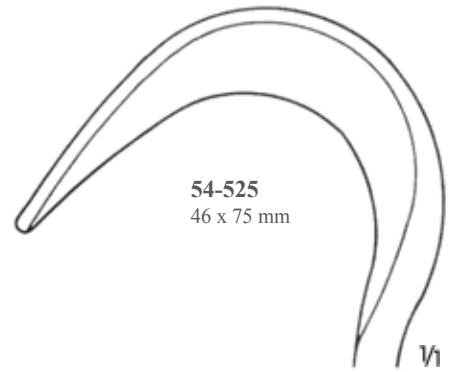
1/2

FRITSCH  
24 cm



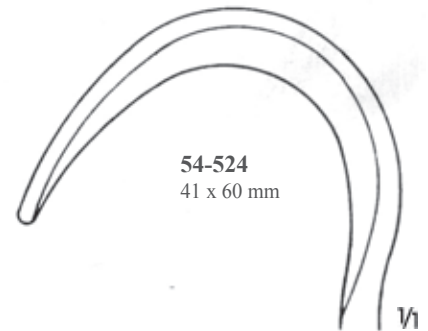
54-526  
64 x 85 mm

1/1



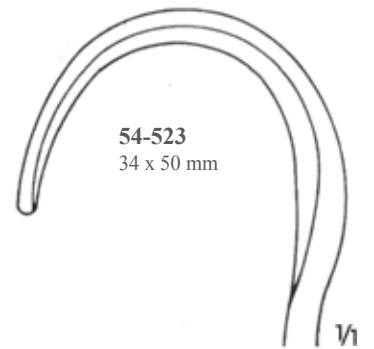
54-525  
46 x 75 mm

1/1



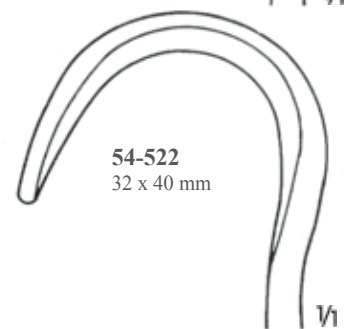
54-524  
41 x 60 mm

1/1



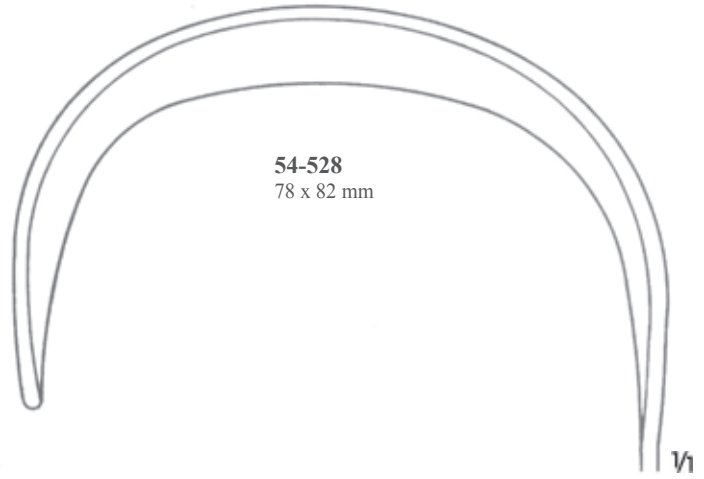
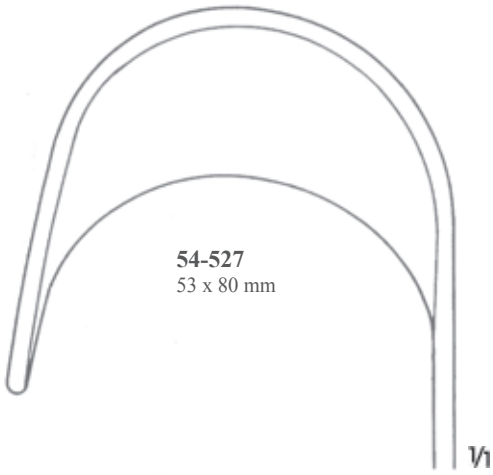
54-523  
34 x 50 mm

1/1



54-522  
32 x 40 mm

1/1







55 x 47 mm

1/2

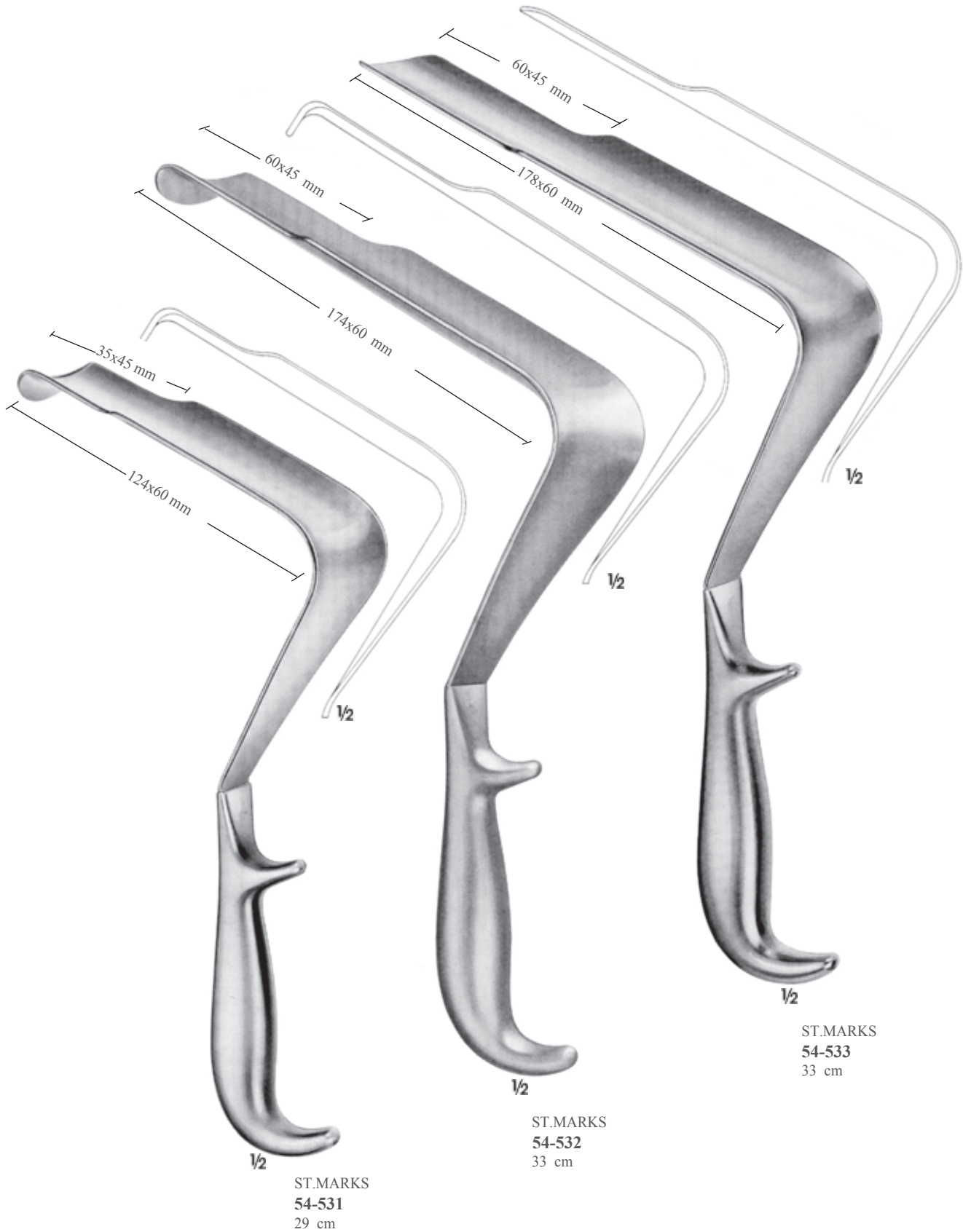
TUDOR-EDWARDS  
54-529  
20.5 cm



58 x 64 mm

1/2

TUFFIER  
54-530  
21.5 cm



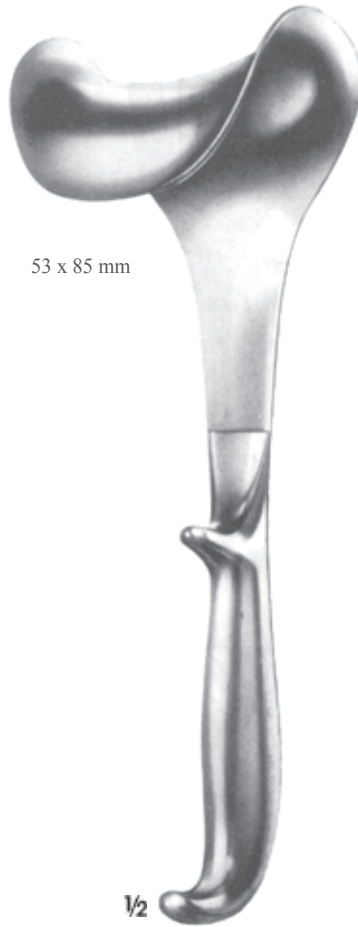


250 x 30 mm

1/2  
MÜLLER  
54-534  
27 cm



DOYEN  
**54-535**  
Işık taşıyıcılı/With light carrier  
25 cm

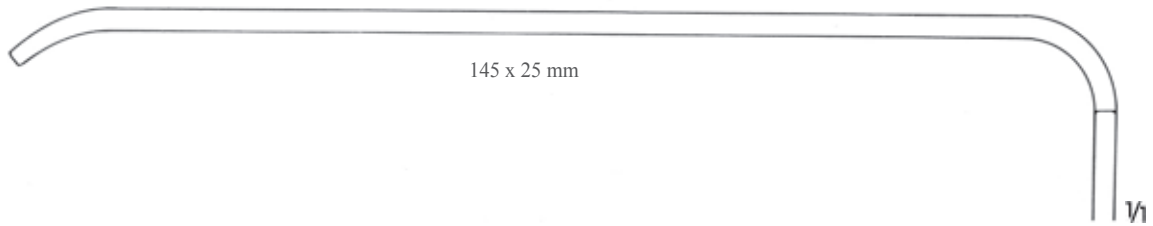


53 x 85 mm  
DOYEN **54-536**  
25 cm



MIKULICZ  
**54-537** 120 x 50 mm  
**54-538** 150 x 50 mm  
Işık taşıyıcılı/With light carrier  
26 cm

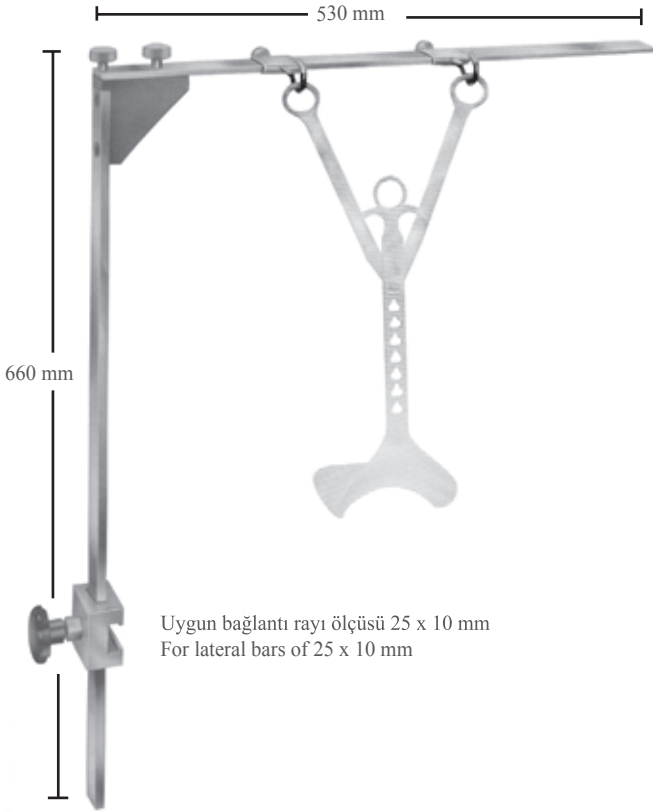




BRUNNER  
**54-539**  
Işık taşıyıcılı/With light carrier  
24 cm



BRUNNER  
**54-540**  
24 cm

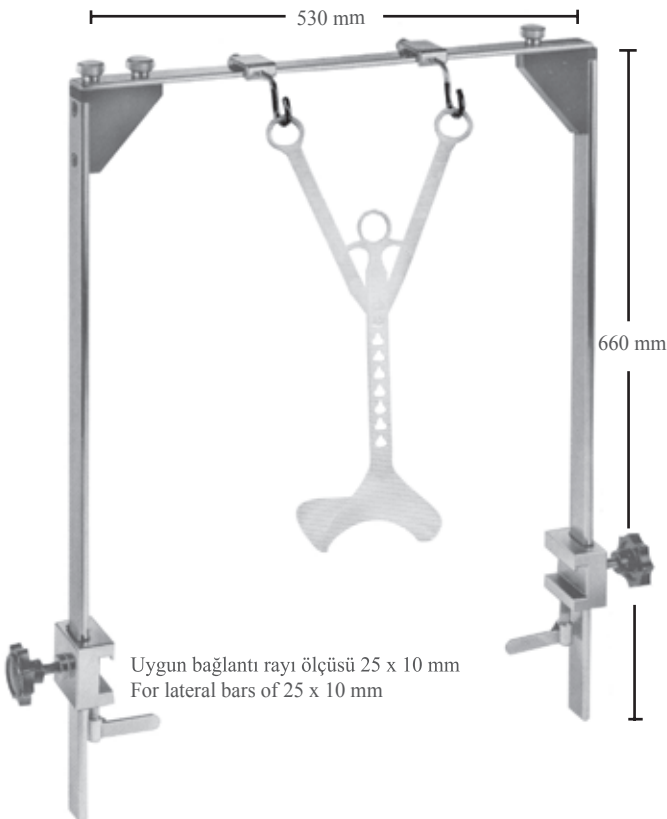


ROCHARD

**54-541**

Daha sağlam bağlantı oluşturmak üzere ameliyat masalarının her iki yan bağlantı rayına bağlanan montaj çerçevesi, sterilizasyon için sökülebilir.

Mounting frame for fastening to both sides of the lateral bars of the operating tables, thus more stability is given, can be dismantled for sterilization.



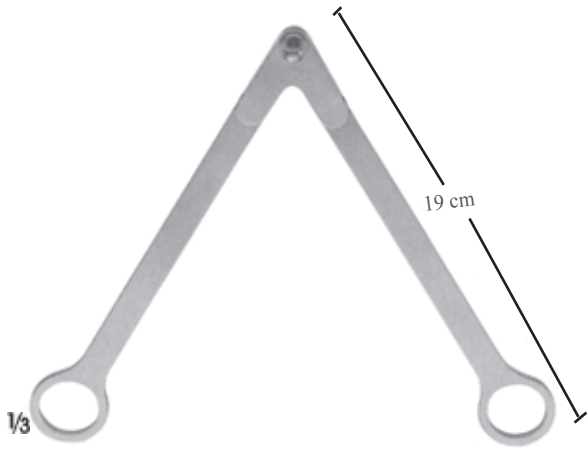
ROCHARD

**54-542**

Daha sağlam bağlantı oluşturmak üzere ameliyat masalarının her iki yan bağlantı rayına bağlanan montaj çerçevesi, sterilizasyon için sökülebilir.

Mounting frame for fastening to both sides of the lateral bars of the operating tables, thus more stability is given, can be dismantled for sterilization.





**ROCHARD**  
**54-543**  
Bağlantı tertibatı  
Fixation device for



**ROCHARD**  
**54-544**



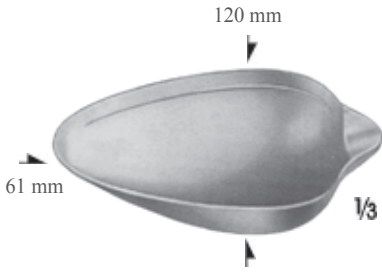
**54-545 Komple /Complete**  
Zincir/With chain  
645 gr.)Ağırlık/Weigth  
79 cm



**DOYEN**  
**54-546** 48 x 90 mm  
**54-547** 48 x 105 mm  
**54-548** 48 x 120 mm  
**54-549** 48 x 135 mm  
28 cm



**ROCHARD**  
**54-550** 48 x 90 mm  
**54-551** 48 x 105 mm  
**54-552** 48 x 120 mm  
**54-553** 48 x 135 mm  
**54-554** 48 x 155 mm  
31 cm



**54-555**  
Kan kaşığı/Blood scoop  
Hacmi 50 cc/Volume 50 cc



**HABERER**  
**54-556**  
Bükülebilir/  
Malleable 30.5 cm



**RIBBON**  
**54-557** 25 mm  
**54-558** 30 mm  
**54-559** 40 mm  
**54-560** 50 mm  
Bükülebilir/Malleable  
33 cm



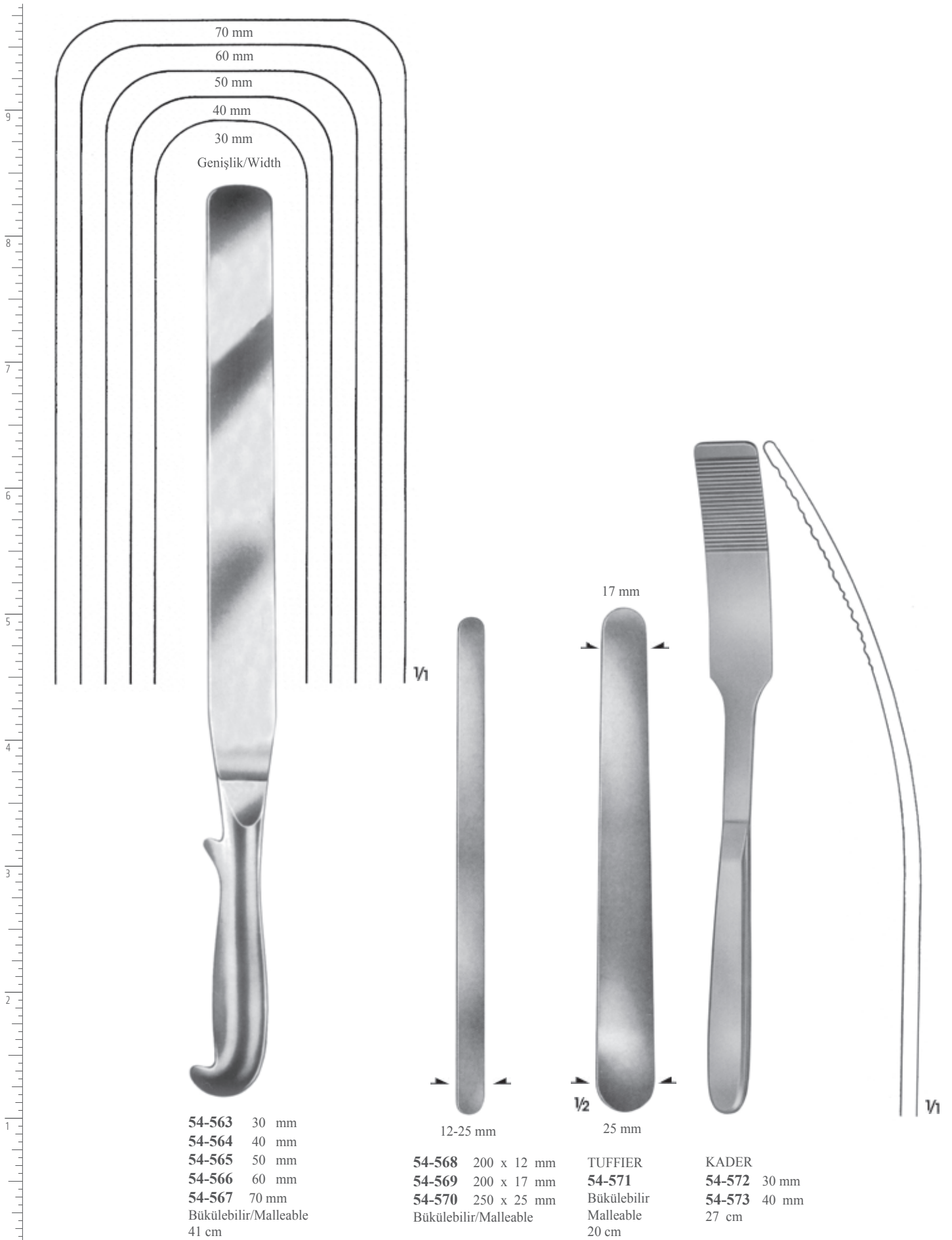
**REVERDIN**  
**54-561**  
28.5 cm



**KOCHER**  
**54-562**  
Kaşık şeklinde bastırıcı  
Depressor, spoon shaped  
22 cm





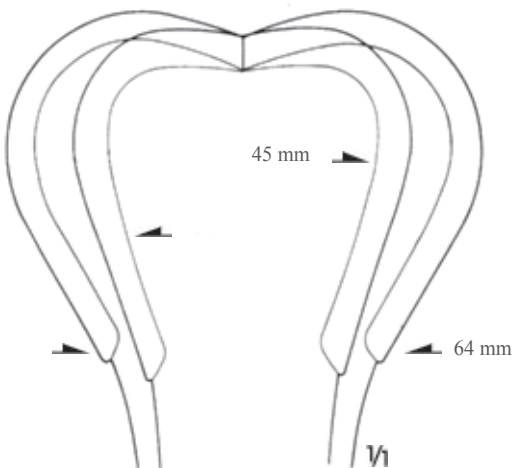
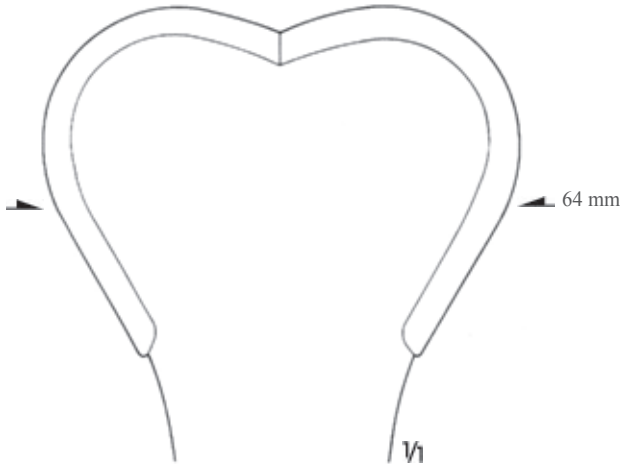


54-563 30 mm  
54-564 40 mm  
54-565 50 mm  
54-566 60 mm  
54-567 70 mm  
Bükülebilir/Malleable  
41 cm

54-568 200 x 12 mm  
54-569 200 x 17 mm  
54-570 250 x 25 mm  
Bükülebilir/Malleable

TUFFIER  
54-571  
Bükülebilir  
Malleable  
20 cm

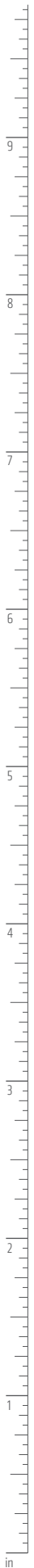
KADER  
54-572 30 mm  
54-573 40 mm  
27 cm



$\frac{1}{2}$   
HARRINGTON-PEMBERTON  
54-574 175 x 64 mm Esnek/  
Flexible  
29.5 cm

$\frac{1}{2}$   
HARRINGTON  
54-575 123 x 45 mm  
54-576 123 x 64 mm  
Esnek/Flexible  
29.5 cm

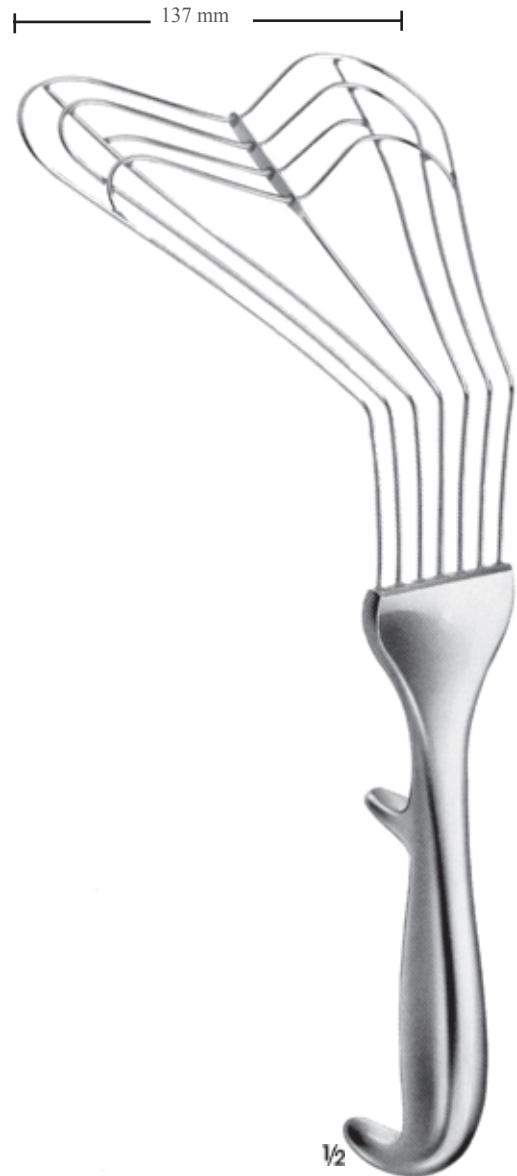




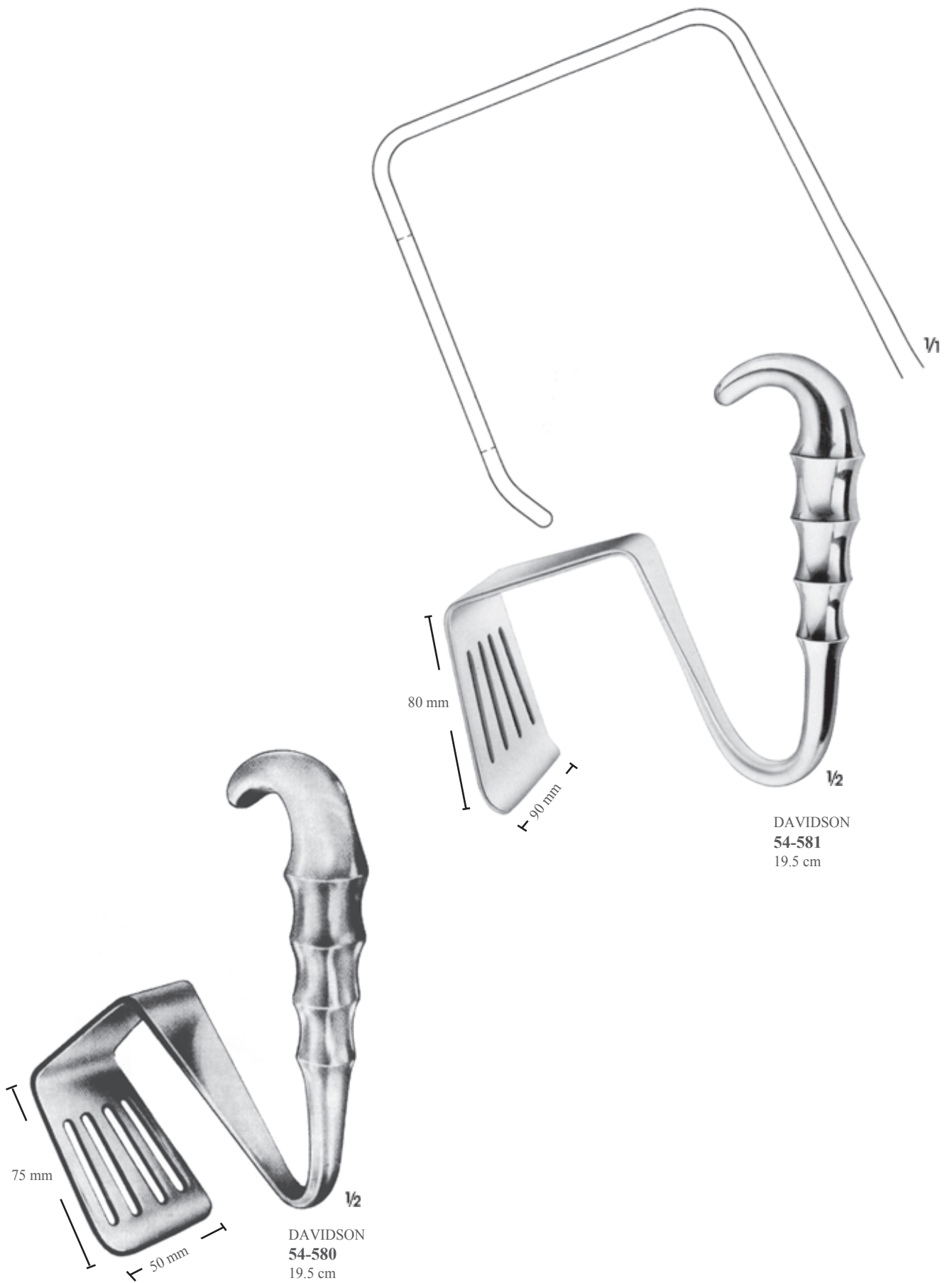
1/2  
ALLISON  
54-577  
25.5 cm



1/2  
ALLISON  
54-578  
32 cm



1/2  
ALLISON  
54-579  
30 cm





25 mm

1/2

DEAVER  
54-582  
23.5 cm



19 mm

1/2

DEAVER  
54-583  
18 cm



22 mm

1/2

DEAVER  
54-584  
21.5 cm

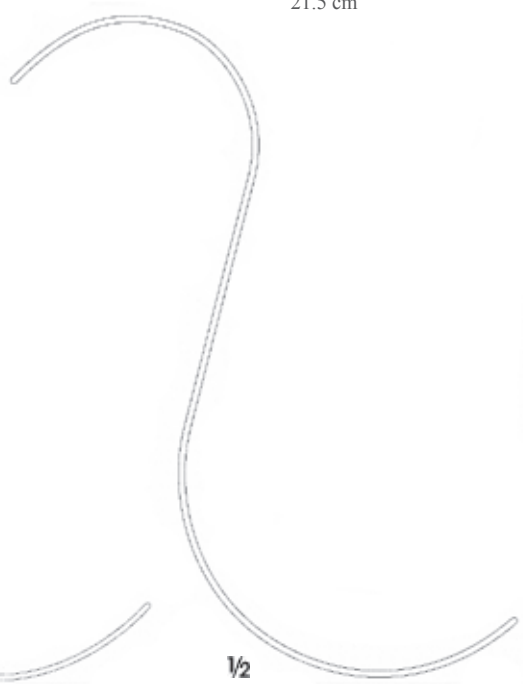


HASSON



1/2

54-585  
10 x 160 mm



1/2

54-586  
13 x 180 mm



$\frac{1}{2}$   
54-587  
26 cm



$\frac{1}{2}$   
BRUNNER  
54-588  
24 cm



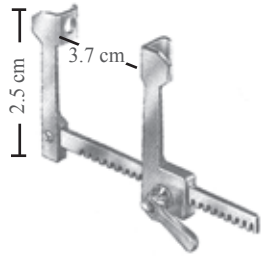


**55**

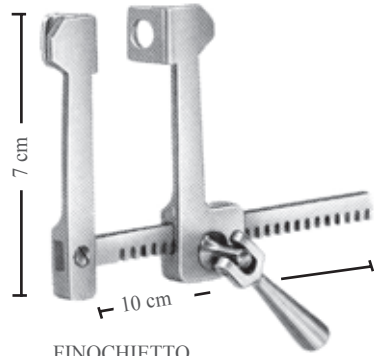




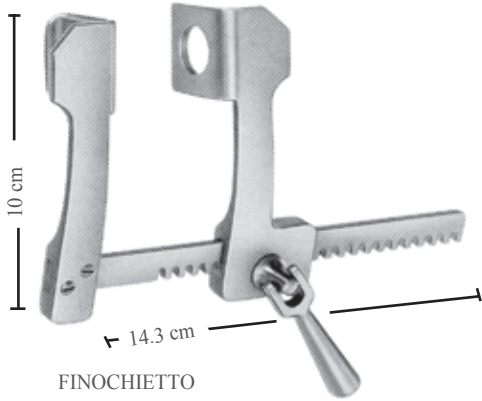




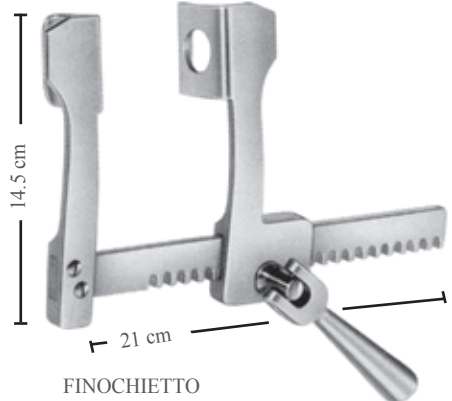
MINI FINOCHIETTO  
**55-100**  
Bleydler/Blades 6 x 7 mm



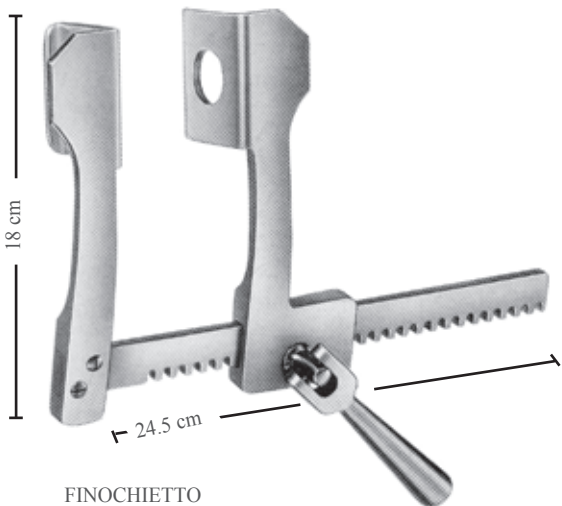
FINOCHIETTO  
**55-101**  
Bleydler/Blades  
12 x 15 mm



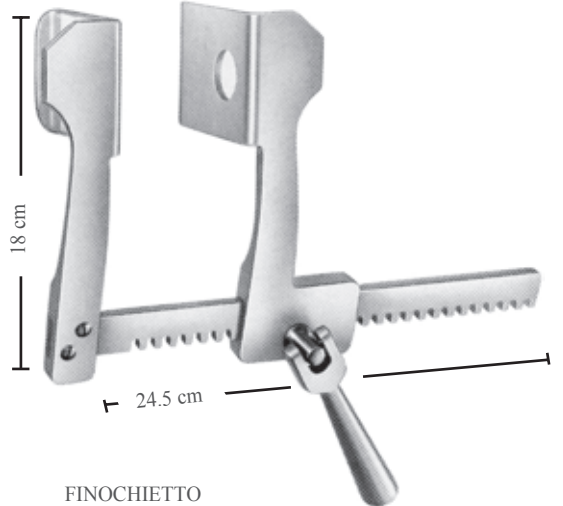
FINOCHIETTO  
**55-102**  
Bleydler/Blades  
28 x 30 mm



FINOCHIETTO  
**55-103**  
Bleydler/Blades 31 x 45 mm



FINOCHIETTO  
**55-104**  
Bleydler/Blades  
42 x 61 mm



FINOCHIETTO  
**55-105**  
Bleydler/Blades  
74 x 64 mm

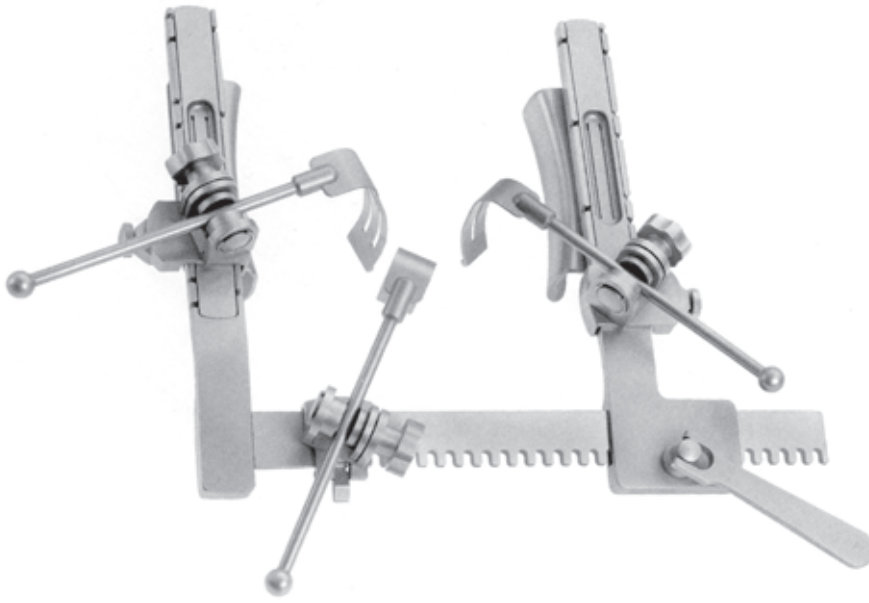


Valf ekartör Sistemi

- Düşük operasyon platformu operasyon alanında cerrahın hareketleri için serbestlik sağlar.
- Aksesuar ve hukların sağlam tesbiti ve mükemmel uygulaması hızlı bağlantı konforu ile birleştirilmiştir.
- Taşıyıcılar kolların ve ayırıcı barların üzerine istenilen pozisyonda takılabilir veya sabitlenebilir.
- Yeni derin valf ekartör dizaynı derin göğüs kafesine sahip hastalarda çalışmak için uygundur.

Valve Retractor System

- The low operating platform provides freedom for surgeon movements in operation area.
- Strong fixation of accessories and hooks and excellent application combined with fast connection comfort.
- Carriers, can be fitted or fixed in any position on the arms and distinctive bars.
- The new deep-valve design of retractor is optimized to work on patients with deep rib cage.



**55-106** 21 x 20 cm Sadece  
Ekartör/Retractor only



**55-107**  
Bağlantı elmanı  
Joint piece



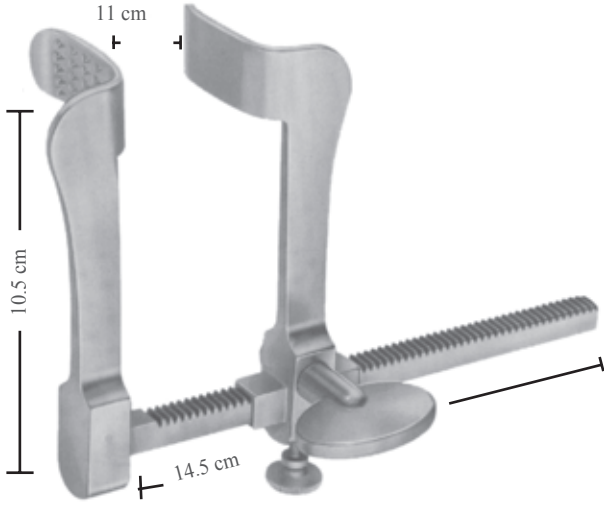
**55-108** 30 x 28 mm  
**55-109** 40 x 28 mm



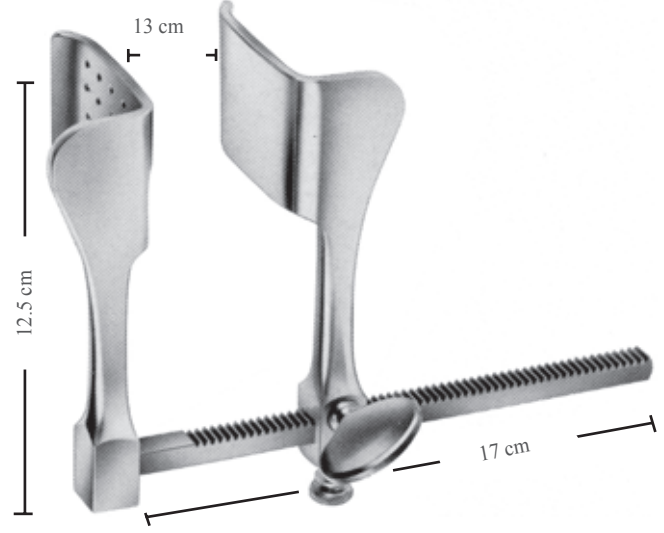
**55-110** 30 x 100 mm  
**55-111** 40 x 100 mm



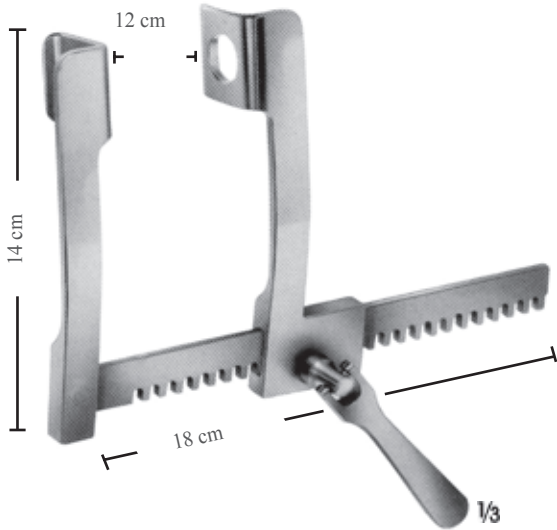
**55-112** Küçük/Small 18 x 52 mm  
**55-113** Orta/Medium 18 x 80 mm  
**55-114** Büyük/Large 22 x 80 mm



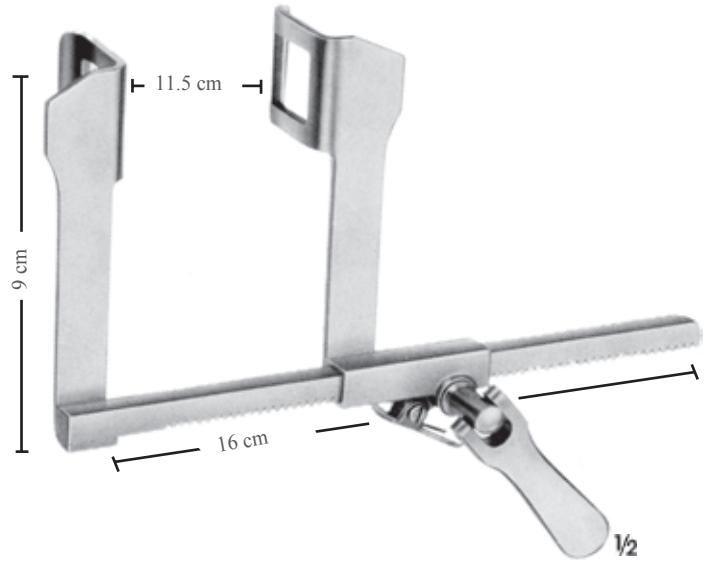
**TUFFIER**  
**55-115**  
Bebekler için göğüs ekartörü  
Rib retractor for infants  
Bleydler/Blades  
32 x 19 mm



**TUFFIER**  
**55-116**  
Göğüs ekartörü/Rib Retractor  
Bleydler/Blades  
43 x 53 mm



**FINOCHIETTO**  
**55-117**  
Göğüs ekartörü/Rib retractor  
Bleydler/Blades  
28 x 32 mm



**HAIGHT**  
**55-118**  
Göğüs ekartörü/Rib retractor  
Bleydler/Blades  
30 x 30 mm

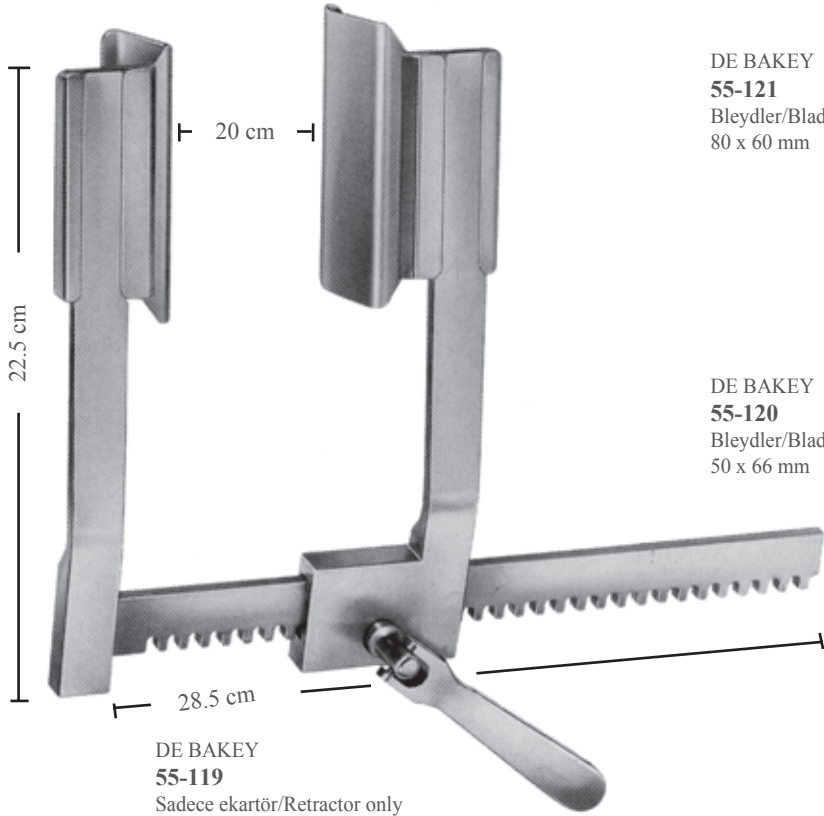


Özel Avantajlar:

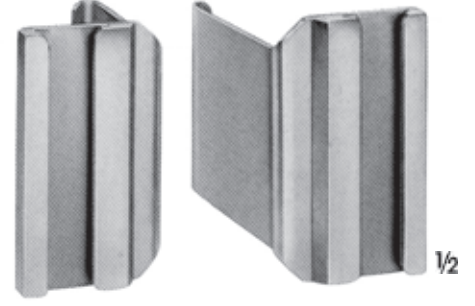
Değiştirilebilir bleydler için geliştirilmiş sabitleme sistemi

Avantaj Special Advantages :

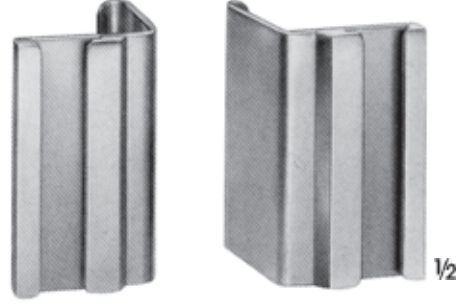
Improved fixing system for interchangeable blades



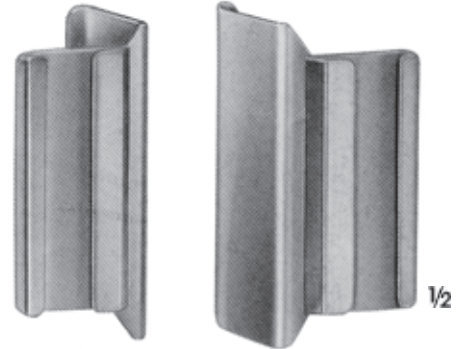
DE BAKEY  
**55-124**  
Bleydler/Blades  
60 x 60 mm



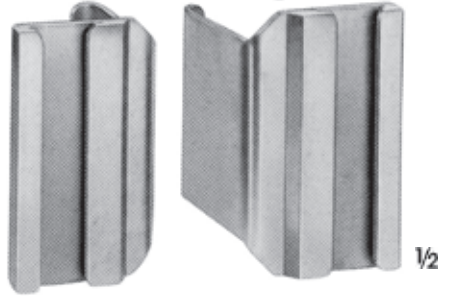
DE BAKEY  
**55-123**  
Bleydler/Blades  
50 x 80 mm



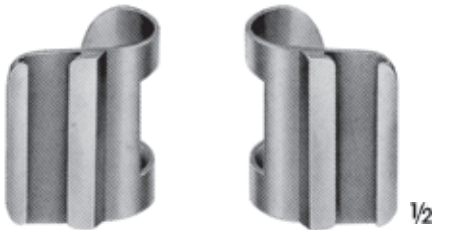
DE BAKEY  
**55-122**  
Bleydler/Blades  
40 x 100 mm

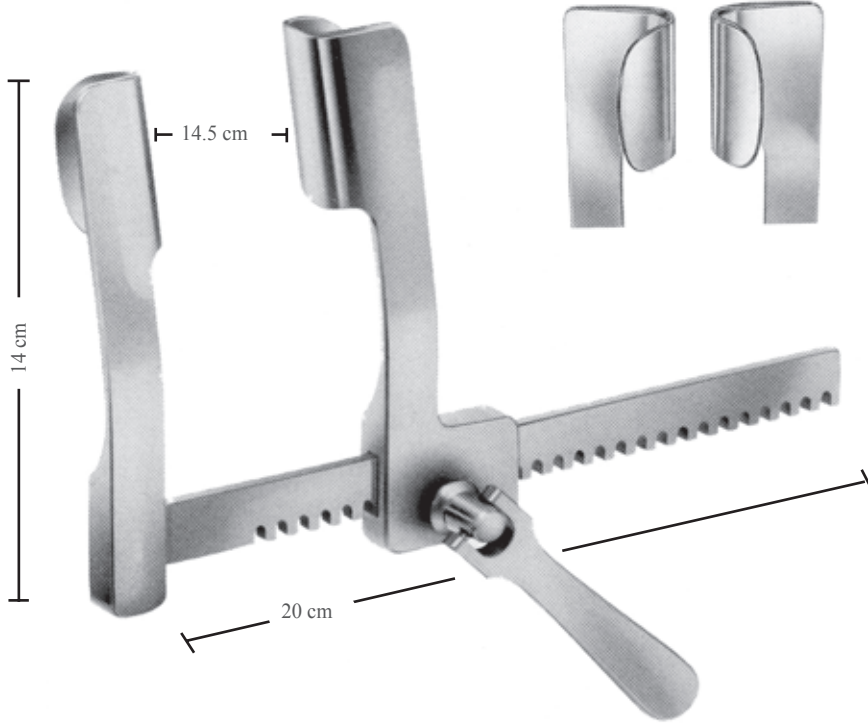


DE BAKEY  
**55-121**  
Bleydler/Blades  
80 x 60 mm

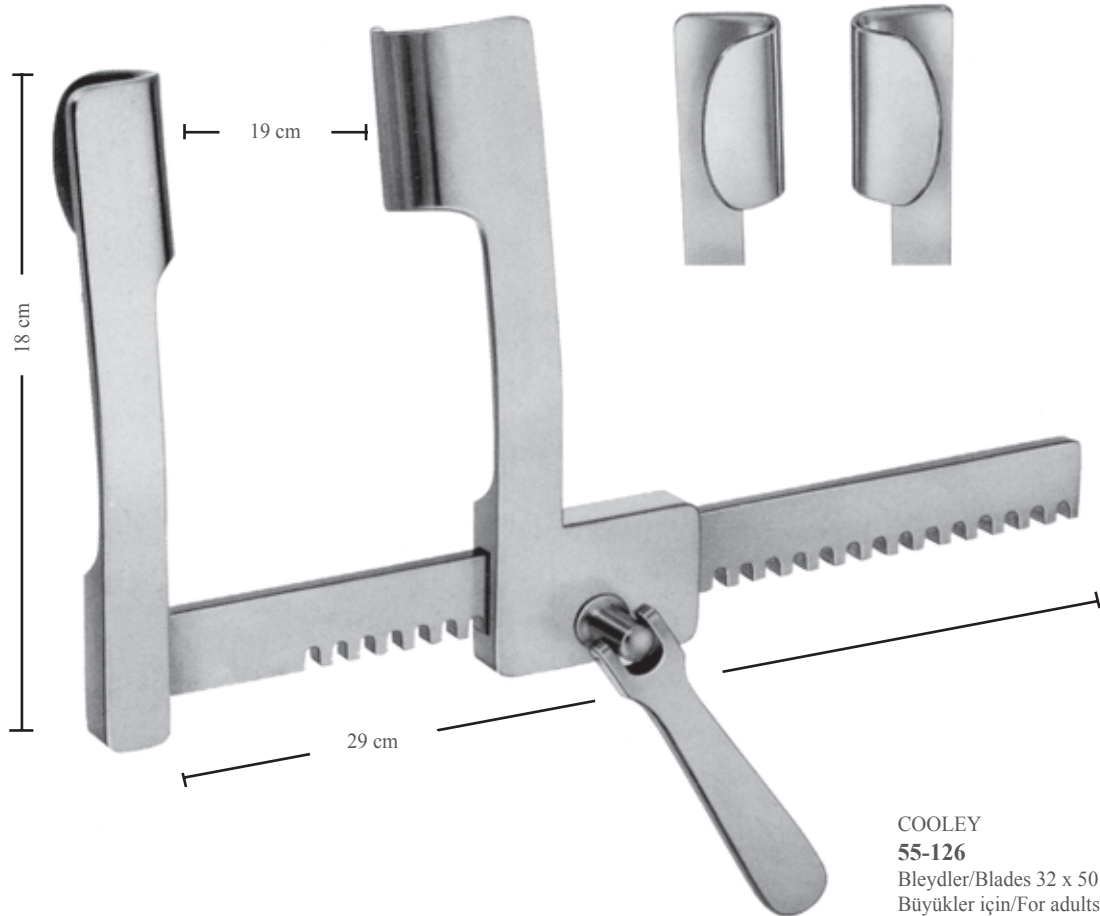


DE BAKEY  
**55-120**  
Bleydler/Blades  
50 x 66 mm





COOLEY  
**55-125**  
Bleydler/Blades 21 x 45 mm  
Çocuklar için/For children

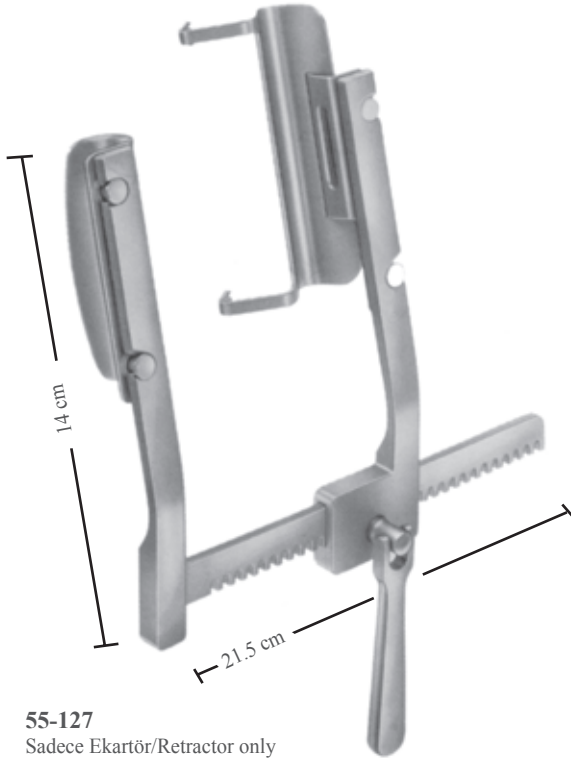


COOLEY  
**55-126**  
Bleydler/Blades 32 x 50 mm  
Büyükler için/For adults

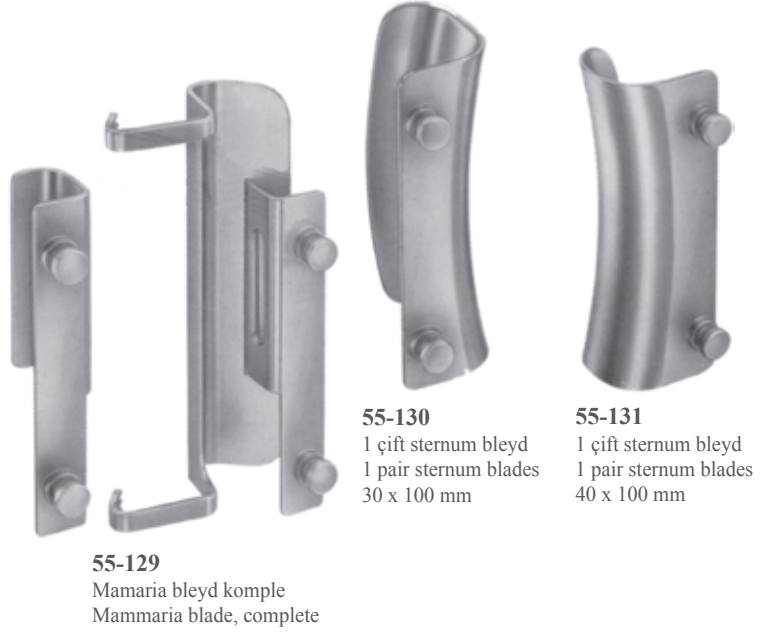


Sternum ekartör veya mamaria interna'nın operasyonuna hazırlanması için kullanılır.

Used as Sternum retractor or used for preparation of the arteria mammaria interna.



**55-127**  
Sadece Ekartör/Retractor only



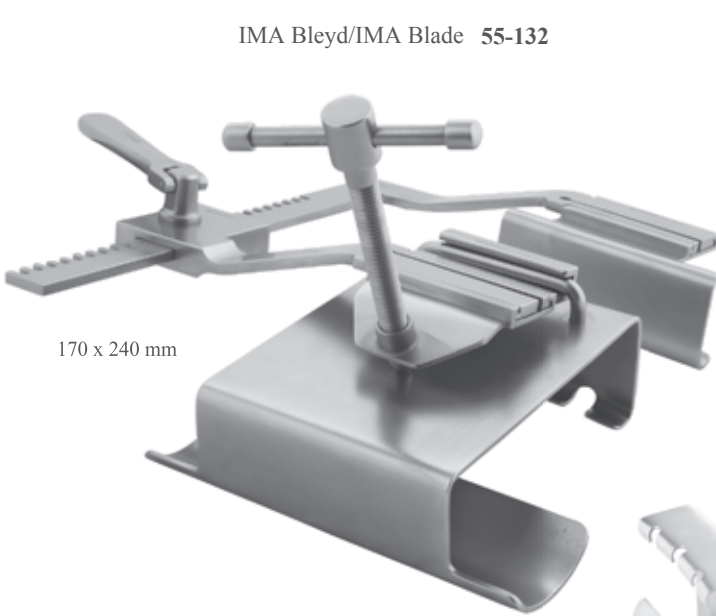
**55-129**  
Mamaria bleyd komple  
Mammaria blade, complete

**55-130**  
1 çift sternum bleyd  
1 pair sternum blades  
30 x 100 mm

**55-131**  
1 çift sternum bleyd  
1 pair sternum blades  
40 x 100 mm

**55-128**  
Mamaria ekartörü komple/Mammaria retractor complete  
55-127 Sadece ekartör/Retractor only  
55-128 Mamaria bleyd komple/Mammaria blade complete L  
55-129 Sternum bleydler(Çift)/Sternum blades(Pair)  
55-130 Sternum bleydler(Çift)/Sternum blades(Pair)

IMA Bleyd/IMA Blade **55-132**



**55-133**



**55-134**



**55-135**  
80 x 100 mm



**55-136**  
100 x 120 mm



**55-137**  
38 x 100 mm







**55-140**  
Bleydler/Blades 75 x 75 mm



**55-139**  
Bleydler/Blades 42 x 65 mm

**55-138**  
Sadece Ekartör/Retractor only



$\frac{1}{2}$   
BOROWSKI

Bükülebilir shaft/Malleable shaft  
27 cm



55-141  
17 x 21 mm



55-142  
16 x 23 mm



55-143  
20 x 25 mm



55-144  
24 x 27 mm



55-145  
28 x 20 mm



55-146  
28 x 29 mm



COOLEY  
**55-147** 25 x 46 mm  
Sol/Left  
28 cm



COOLEY  
**55-148** 45 x 30 mm  
**55-149** 45 x 35 mm  
**55-150** 45 x 48 mm  
Dişsiz/Unserrated  
24.5 cm





1/2  
COOLEY  
55-151  
Sol/Left  
28 cm



1/2  
COOLEY  
55-152  
Sağ/Right  
27 cm



45 x 30 mm

1/2

COOLEY  
**55-153**  
Ince dişli/Slightly serrated  
26.5 cm



45 x 35 mm

1/2

COOLEY  
**55-154**  
Ince Dişli/Slightly serrated  
26.5 cm

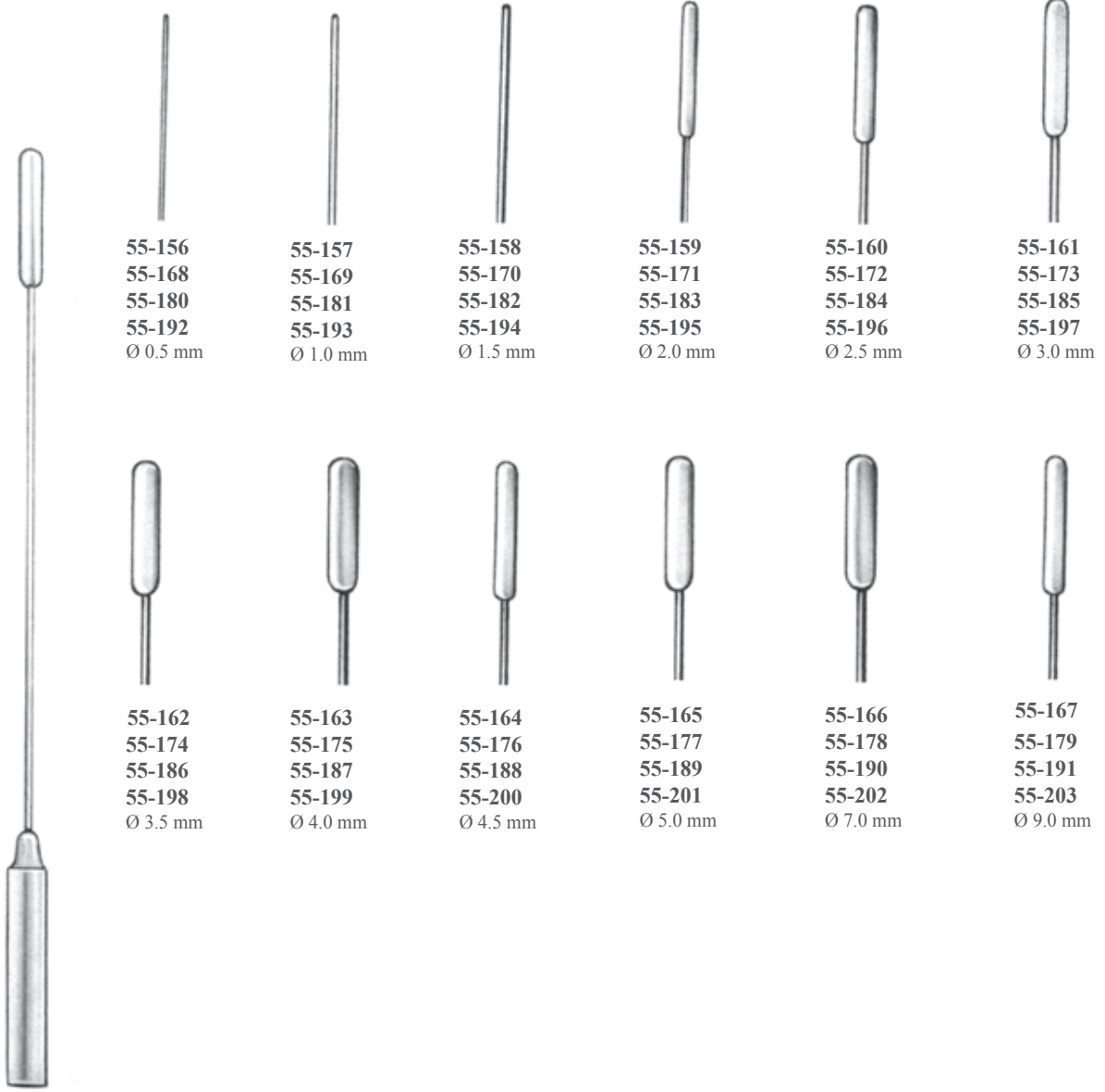


45 x 48 mm

1/2

COOLEY  
**55-155**  
Sağ ince dişli/Right, slightly serrated  
27 cm





55-156  
55-168  
55-180  
55-192  
Ø 0.5 mm

55-157  
55-169  
55-181  
55-193  
Ø 1.0 mm

55-158  
55-170  
55-182  
55-194  
Ø 1.5 mm

55-159  
55-171  
55-183  
55-195  
Ø 2.0 mm

55-160  
55-172  
55-184  
55-196  
Ø 2.5 mm

55-161  
55-173  
55-185  
55-197  
Ø 3.0 mm

55-162  
55-174  
55-186  
55-198  
Ø 3.5 mm

55-163  
55-175  
55-187  
55-199  
Ø 4.0 mm

55-164  
55-176  
55-188  
55-200  
Ø 4.5 mm

55-165  
55-177  
55-189  
55-201  
Ø 5.0 mm

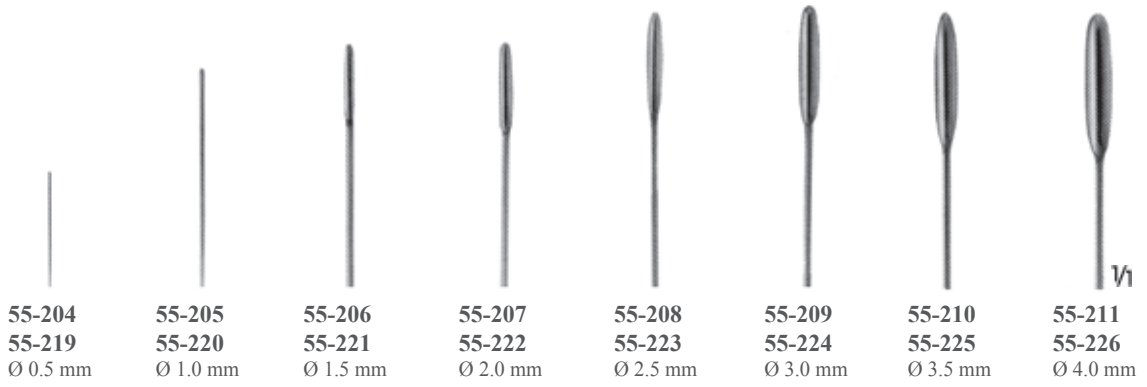
55-166  
55-178  
55-190  
55-202  
Ø 7.0 mm

55-167  
55-179  
55-191  
55-203  
Ø 9.0 mm

GARRET

55-156 - 55-167 14 cm  
55-168 - 55-179 19 cm  
55-180 - 55-191 21 cm  
55-192 - 55-203 35 cm

Bükülebilir/Malleable



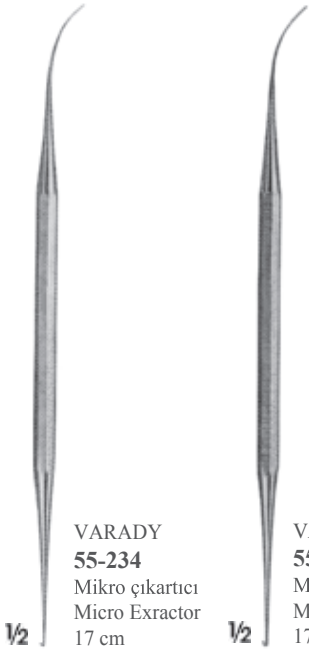
DE BAKEY

55-204 - 55-218 19 cm

55-219 - 55-233 38 cm

Damar dilatörleri, bükülebilir  
Vascular dilators, malleable





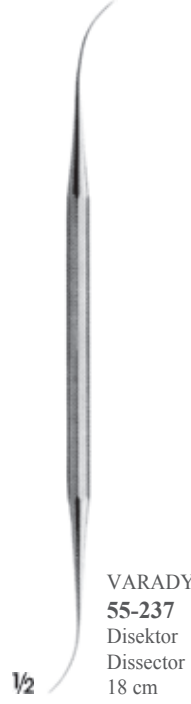
**VARADY 55-234**  
Mikro çıkartıcı  
Micro Extractor  
17 cm



**VARADY 55-235**  
Mini çıkartıcı  
Mini Extractor  
17 cm



**VARADY 55-236**  
Mikro spatula,  
çift taraflı  
Micro spatula,  
double ended  
17.5 cm



**VARADY 55-237**  
Dissektor  
Dissector  
18 cm



**VARADY 55-238**  
Çıkartıcı  
Extractor  
18 cm



**VARADY 55-239**  
Çıkartıcı  
Extractor  
18 cm



**VARADY 55-240** Mini damar temizleme seti  
Mini vein stripper set



**VARADY 55-241**  
Esnek kablo  
Flexible cable  
45 cm



**55-242**  
Ø 3 mm



**55-243**  
Ø 4 mm



**55-244**  
Ø 5 mm



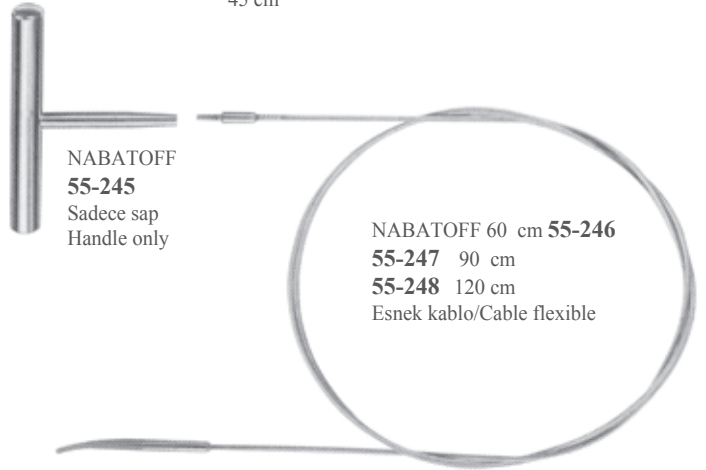
**NABATOFF 55-249** Damar temizleme seti/Vein stripper set, consisting of



**55-250**  
Esnek plastik sonda ucu  
Flexible plastic probe tip



**55-251**  
Ø 3 mm  
Metal sonda ucu  
Metal Probe tip



**NABATOFF 55-245**  
Sadece sap  
Handle only

**NABATOFF 60 cm 55-246**  
**55-247** 90 cm  
**55-248** 120 cm  
Esnek kablo/Cable flexible



**55-252**  
Ø 6 mm



**55-253**  
Ø 9 mm



**55-254**  
Ø 12 mm



**55-255**  
Ø 15 mm





**55-256**  
Mikro disektör  
Micro dissector  
23 cm



1/1



**55-257**  
15.5 cm

**SCHMID**  
Disektörler/Dissectors  
Künt/Blunt



1/1



**55-258**  
23.5 cm

1/1



**HALLE**  
**55-259**  
Elavatör/Elevators  
Künt/Blunt  
18 cm

3.3 mm



1/1



**FREER**  
**55-260**  
Raspa/Raspatory  
Sivri/Sharp  
Künt/Blunt  
18.5 cm



1/1



**TÖNNIS**  
**T17-200 - T17-201**  
Disektörler/Dissectors  
24 cm



**55-261**



**55-262**

1/1



1/1



**55-263** 18.5 cm  
**55-264** 21.5 cm  
Intima disektörü, künt  
Intima dissector, blunt

3 mm



1/1



**DAVIS**  
**55-265**  
Disektör/Dissector  
24.5 cm



1/1



55-266



55-267

DOYEN  
Çocuklar için/For  
children 17.5 cm



55-268



55-269

DOYEN  
Buyukler için/For adults  
17.5 cm

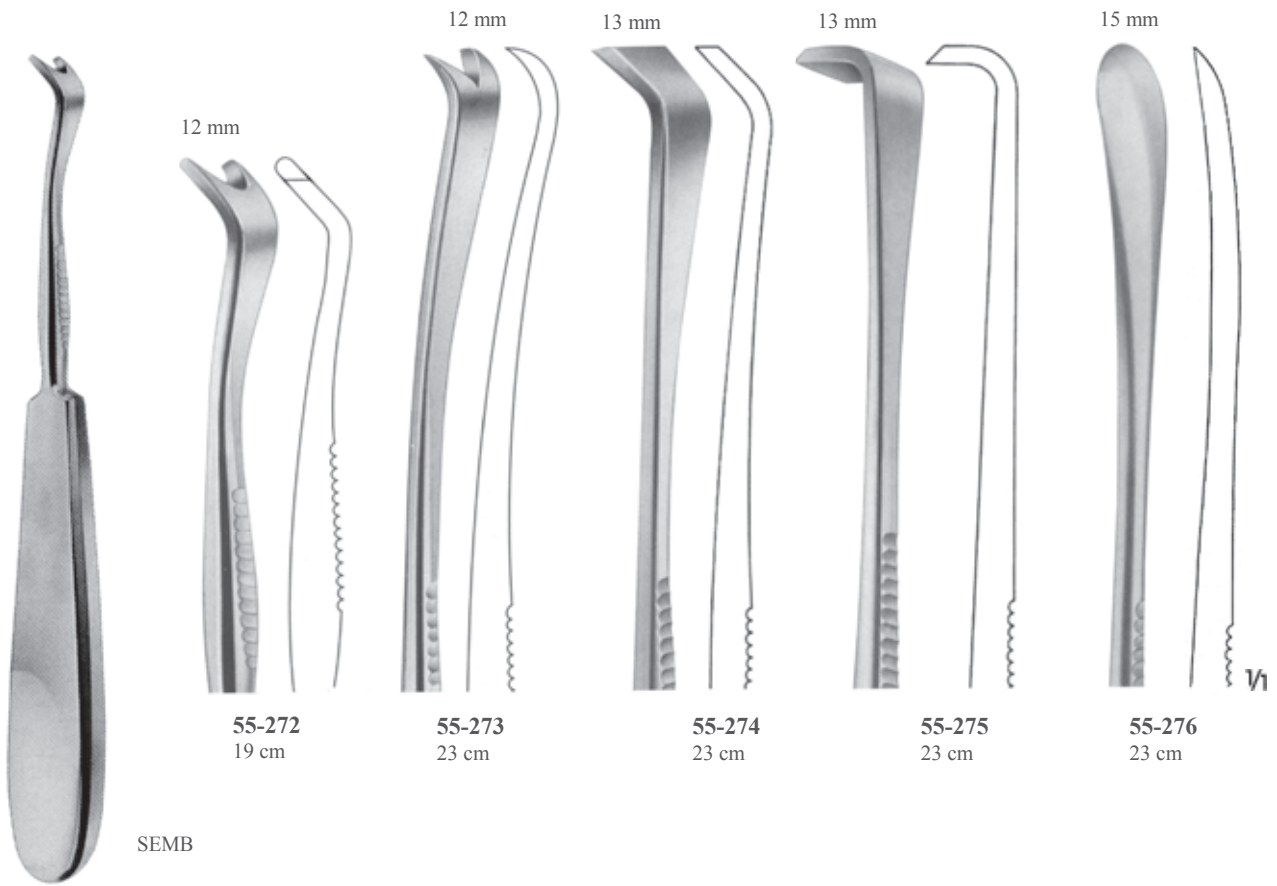


55-270

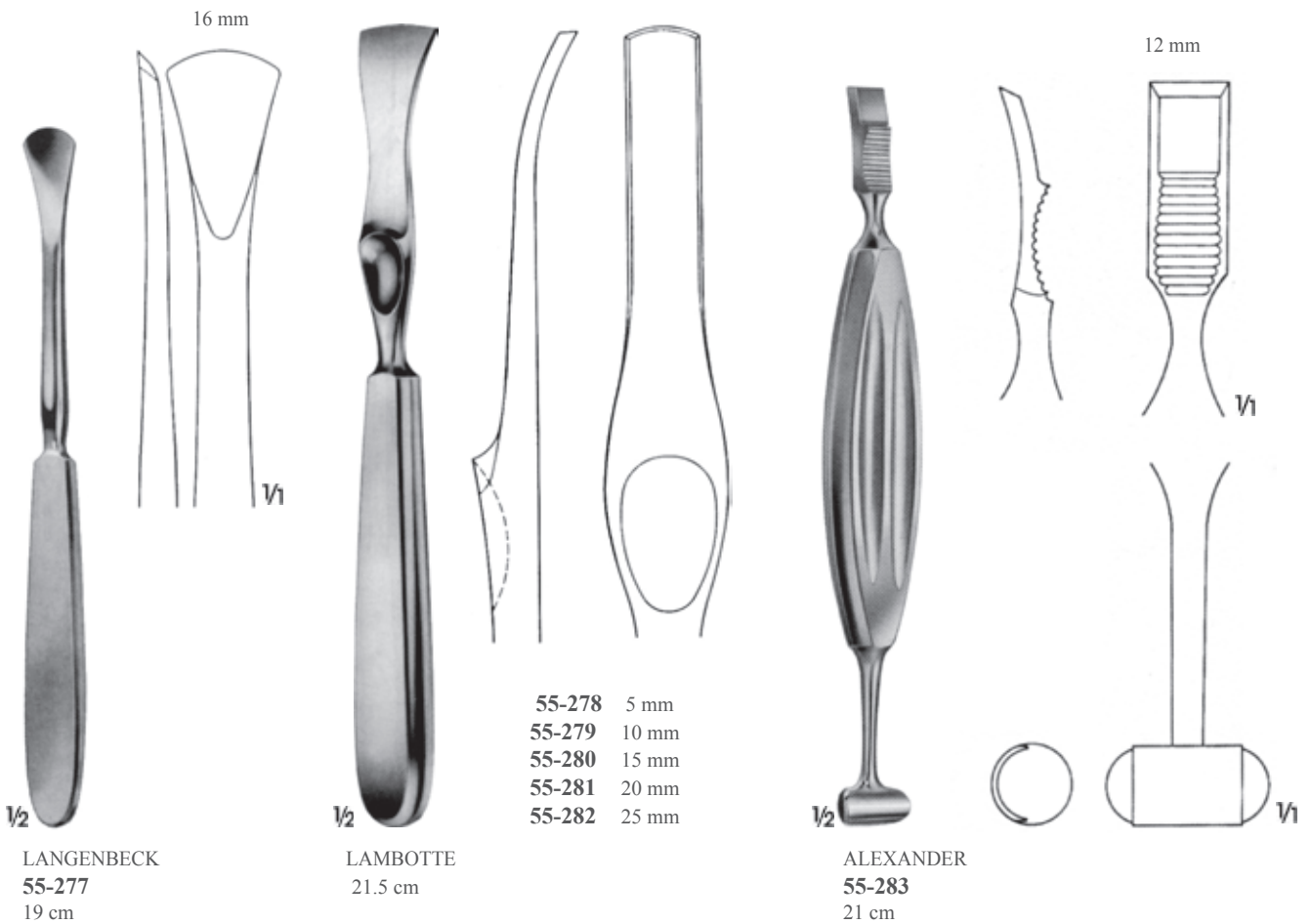


55-271

DOYEN  
24 cm



SEMB

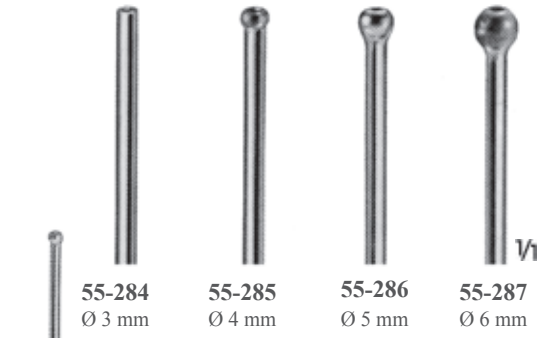


LANGENBECK  
55-277  
19 cm

LAMBOTTE  
21.5 cm

ALEXANDER  
55-283  
21 cm

- 55-278 5 mm
- 55-279 10 mm
- 55-280 15 mm
- 55-281 20 mm
- 55-282 25 mm



**55-284** Ø 3 mm  
**55-285** Ø 4 mm  
**55-286** Ø 5 mm  
**55-287** Ø 6 mm

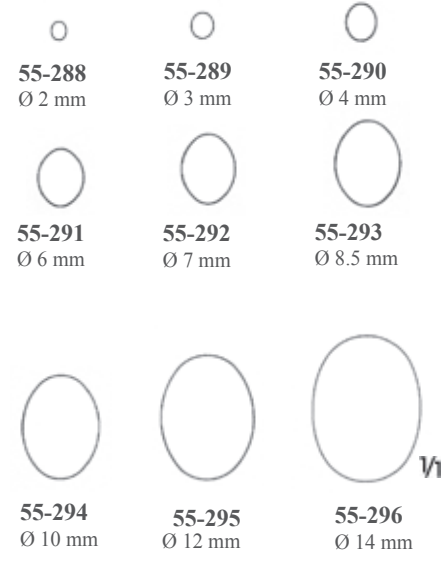
1/2 LUER LOCK

SCHMID  
 Damar sulama kanülleri,  
 malleable, silver plated 15 cm



135°

Endarterektomi temizleyici Endarterectomy strippers 55 cm



**55-288** Ø 2 mm  
**55-289** Ø 3 mm  
**55-290** Ø 4 mm  
**55-291** Ø 6 mm  
**55-292** Ø 7 mm  
**55-293** Ø 8.5 mm  
**55-294** Ø 10 mm  
**55-295** Ø 12 mm  
**55-296** Ø 14 mm



1/2 **55-297**  
 Sap/For handle 11 cm



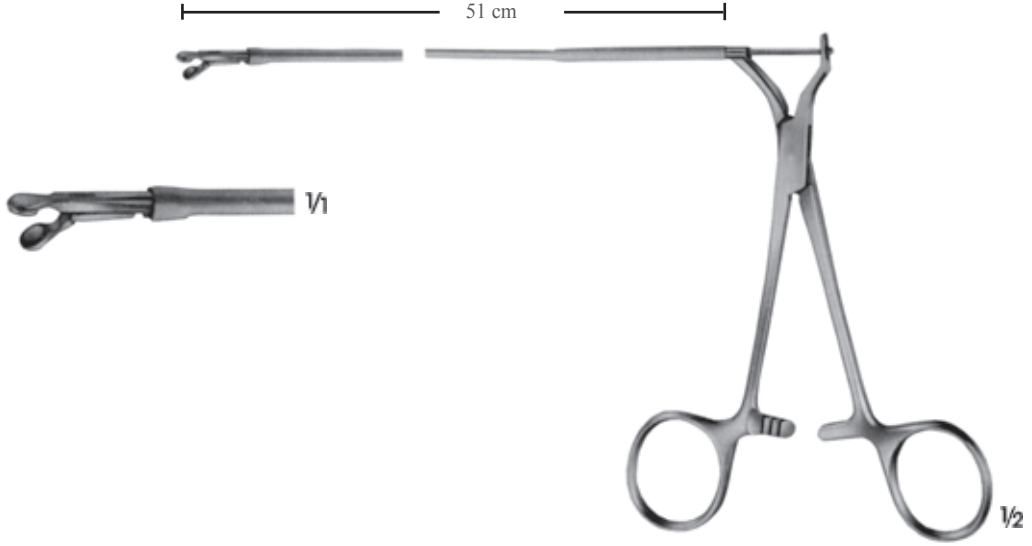
**55-298**  
Sadece klavuz  
Guide only



**55-299**  
Sadece klavuz  
Guide only



**RUMEL-BELMONT**  
Turnikeler/Tourniquets  
**55-300** Ø 4.0 mm  
**55-301** Ø 6.4 mm  
32.5 cm



SCHULZ  
55-302

Esnek milli biyoptom, 51 cm uzunluğunda  
Ø 3 mm yuvarlak çeneli  
Bioptome, with flexible shaft 51 cm long,  
with round jaws Ø 3 mm



14 cm  
Aort pançları/Aorta punches



55-303  
Ø 4 mm



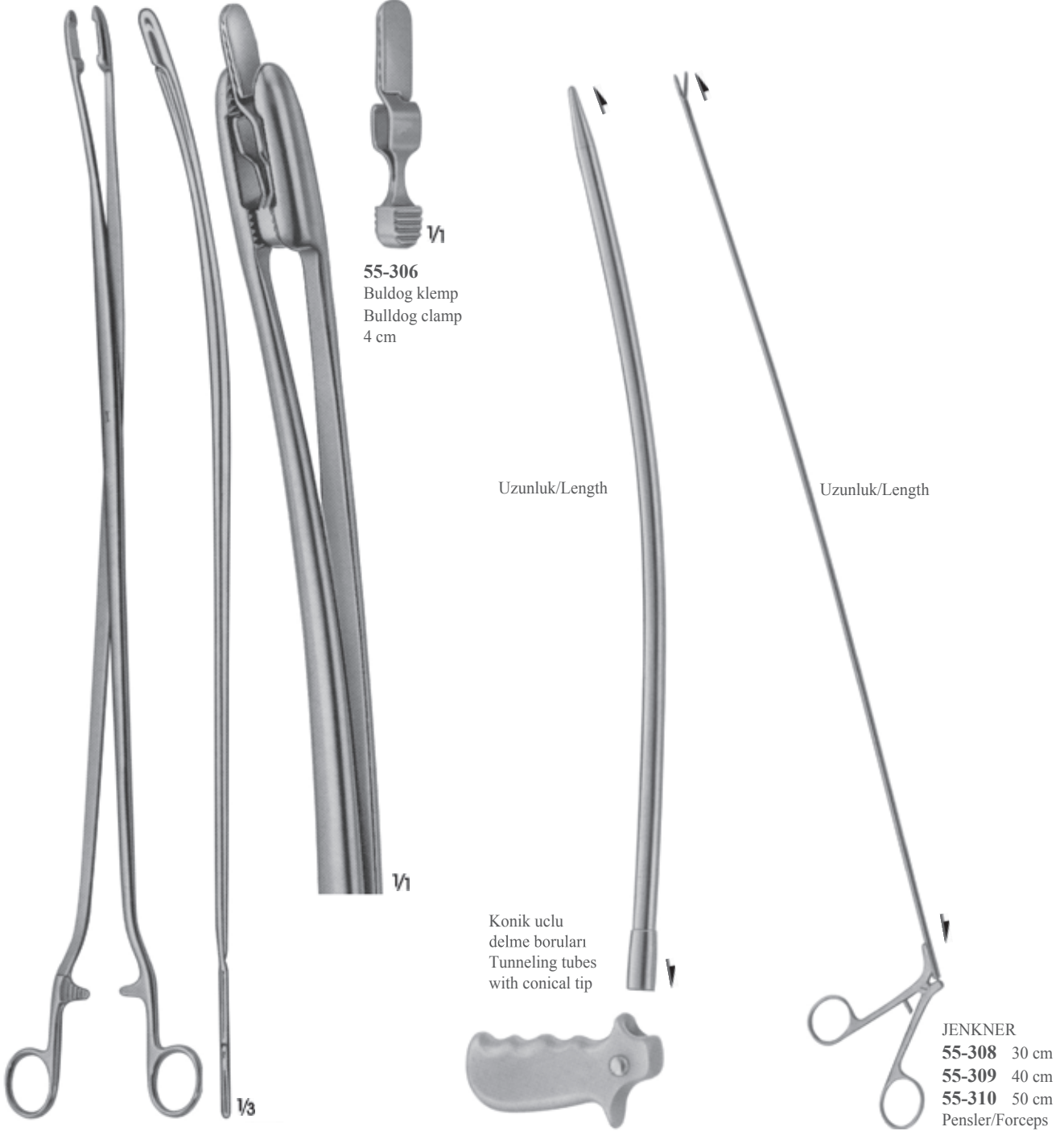
55-304  
Ø 5 mm



55-305  
Ø 6 mm

Buldog pens sürücüsü, ince ve hafif eğri yapısı ile tünel boyunca kolay ilerleme sağlar.  
Buldog pensini güvenli şekilde kavrur.

The slight curvature of the introducer forceps permits handling during tunneling. Here the prosthesis can be drawn in by applying the introducer forceps directly to the prosthesis (alloplastic prosthesis) or can be drawn in by means of the buldog clamp (autologous/homologous prosthesis). Thanks to the interlocking fit, the buldog clamp rests non-displaceable and securely in the mouth of the introducer forceps.



ALLENBERG  
**55-307**  
Eğri/Curved  
54 cm

**55-306**  
Buldog klamp  
Bulldog clamp  
4 cm

Uzunluk/Length

Uzunluk/Length

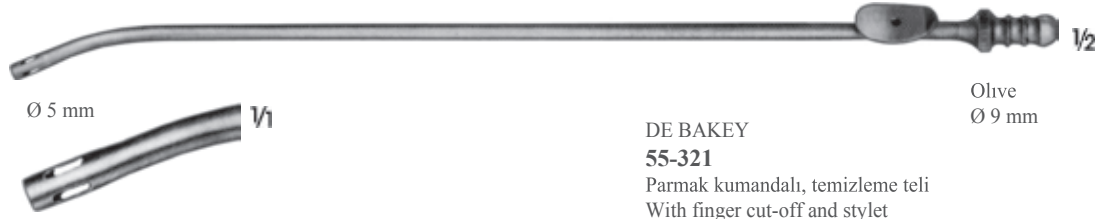
Konik uclu  
delme boruları  
Tunneling tubes  
with conical tip

JENKNER  
**55-308** 30 cm  
**55-309** 40 cm  
**55-310** 50 cm  
Pensler/Forceps

Konik uclu delme boruları Tunneling tubes with conical tip	Uzunluk Length 30 cm	Uzunluk Length 40 cm	Uzunluk Length 50 cm
Ø 12 mm	<b>55-311</b>	<b>55-314</b>	<b>55-317</b>
Ø 14 mm	<b>55-312</b>	<b>55-315</b>	<b>55-318</b>
Ø 17 mm	<b>55-313</b>	<b>55-316</b>	<b>55-319</b>



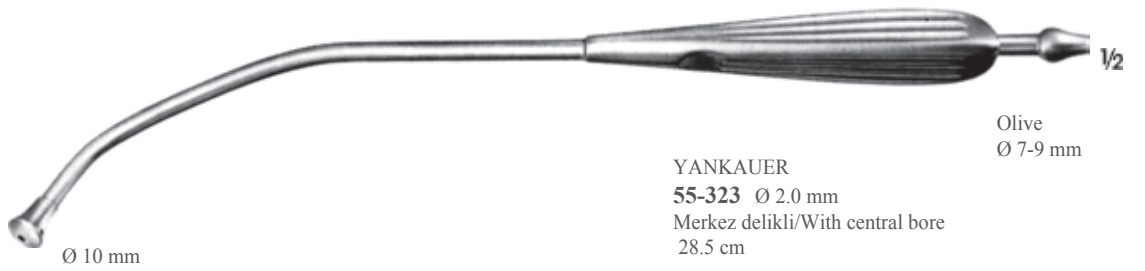
DE BAKEY  
**55-320**  
Parmak kumandalı, temizleme teli  
With finger cut-off and stylet  
16 cm



DE BAKEY  
**55-321**  
Parmak kumandalı, temizleme teli  
With finger cut-off and stylet  
27 cm



DE BAKEY  
**55-322**  
Merkez delikli, Ø 3.0 mm yanıl yuvalı  
With central bore, Ø 3.0 mm with lateral  
slots  
27.5 cm



YANKAUER  
**55-323** Ø 2.0 mm  
Merkez delikli/With central bore  
28.5 cm



FINSTERER  
**55-324**  
Kombine aspiratör ucu  
ve irrigasyon kanülü  
Combined suction and  
irrigation cannula  
32 cm





WITT  
**55-325** 1.5 x 35 mm  
**55-326** 1.5 x 51 mm  
Sternal delme iğnesi,  
Luer bağlantılı  
Sternal puncture needle  
with Luer cone

1/1



LEBSCHKE  
**55-327**  
Sternum çizili  
Sternum chisel  
20 cm

1/2



SCHUMACHER  
**55-328**  
Sternum makası  
Sternum shears  
21 cm

1/2





GLUCK  
55-329  
19 cm

1/3



55-330  
23 cm

1/3



SAUERBRUCH  
55-331  
Çocuklar için  
For children  
24 cm

55-332  
Büyükler için  
For adults  
27 cm



GIERTZ-STILLE  
55-333  
25 cm

1/3



BRUNNER  
55-334  
Üniversal model  
Universal pattern  
34 cm

1/3



BETHUNE  
55-335  
34 cm

1/3



SEM B  
55-336  
Kaburga ve kemik tutma pensi  
Rib-and bone holding forcep  
19 cm



SEM B  
55-337  
Kaburga ve kemik tutma pensi  
Rib-and bone holding forcep  
19 cm



BAILEY  
55-338  
Göğüs ekartörü/Rib spreader  
15 cm



SELLORS  
55-339  
Göğüs ekartörü/Rib spreader  
Oynak bleydli/With swivel blades  
20 cm

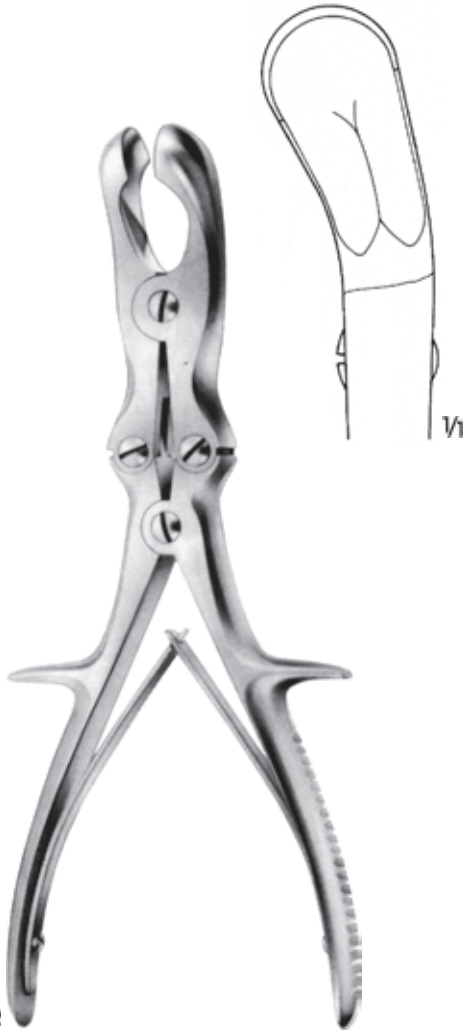


BAILEY  
55-340  
Çocuklar için  
For children

BAILEY  
55-341  
Büyükler için  
For adults

BAILEY  
Göğüs ekartörü/Rib spreader  
20 cm

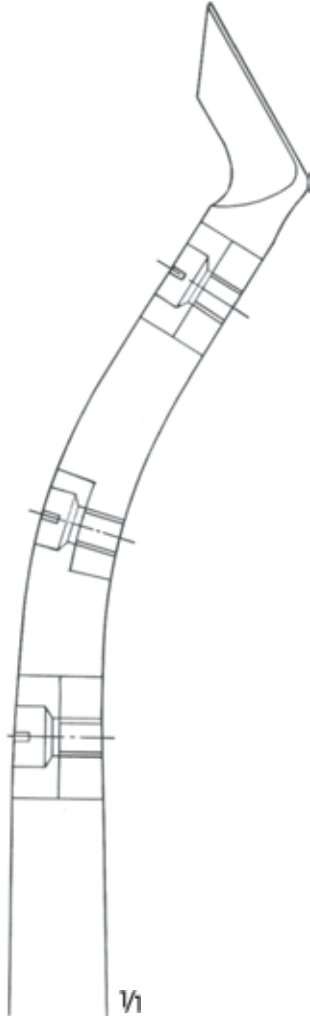




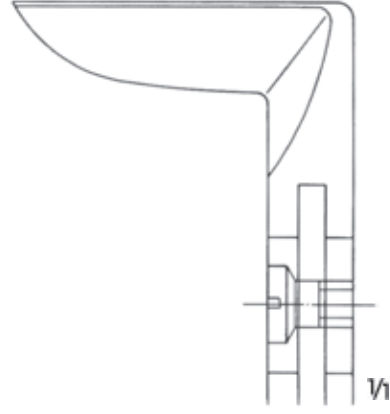
SEMB  
55-342  
Kemik ronjur  
kaba kemikleri için  
Rib rongeur to shorten  
the rib stumps  
24 cm



SAUERBRUCH-CORYLLOS  
Kemik ronjur  
kaba kemikleri için  
Rib rongeur to shorten  
the rib stumps  
31 cm



LISTON-KEY-HORSLEY  
55-345  
S şekilli, arka kaburga uçları için  
S-Shaped for posterior rib ends  
25.5 cm



LISTON-STILLE  
55-346  
Açılı/Aggled  
26.5 cm





**56**



**56-100**  
Karşı ekartör  
Counter retractor



**56-101**  
Çift hareketli karşı ekartör  
Double hinged retractor used for  
longidinal retraction



**56-102**  
Çift hareketli servikal ekartör  
Double hinged cervical retractor



**56-103** 30 x 24 mm  
**56-104** 35 x 24 mm  
**56-105** 40 x 24 mm  
**56-106** 45 x 24 mm  
**56-107** 50 x 24 mm  
**56-108** 55 x 24 mm  
**56-109** 60 x 24 mm  
**56-110** 65 x 24 mm  
**56-111** 70 x 24 mm  
Titanyum orta bleyd  
Mediall blades titanium



**56-112** 30 x 24 mm  
**56-113** 35 x 24 mm  
**56-114** 40 x 24 mm  
**56-115** 45 x 24 mm  
**56-116** 50 x 24 mm  
**56-117** 55 x 24 mm  
**56-118** 60 x 24 mm  
**56-119** 65 x 24 mm  
**56-120** 70 x 24 mm  
Titanyum yan bleyd  
Lateral blades titanium



**56-121** 35 x 24 mm  
**56-122** 40 x 24 mm  
**56-123** 45 x 24 mm  
**56-124** 50 x 24 mm  
**56-125** 55 x 24 mm  
**56-126** 60 x 24 mm  
**56-127** 65 x 24 mm  
**56-128** 70 x 24 mm  
**56-129** 75 x 24 mm  
Titanyum künt bleyd  
Blunt blades titanium



**56-130** 30 x 24 mm  
**56-131** 35 x 24 mm  
**56-132** 40 x 24 mm  
**56-133** 45 x 24 mm  
**56-134** 50 x 24 mm  
**56-135** 55 x 24 mm  
**56-136** 60 x 24 mm  
**56-137** 65 x 24 mm  
**56-138** 70 x 24 mm  
Titanyum orta bleyd  
Mediall blades titanium



**56-139** 30 x 24 mm  
**56-140** 35 x 24 mm  
**56-141** 40 x 24 mm  
**56-142** 45 x 24 mm  
**56-143** 50 x 24 mm  
**56-144** 55 x 24 mm  
**56-145** 60 x 24 mm  
**56-146** 65 x 24 mm  
**56-147** 70 x 24 mm  
Titanyum yan bleyd  
Lateral blades titanium



**56-148** 35 x 24 mm  
**56-149** 40 x 24 mm  
**56-150** 45 x 24 mm  
**56-151** 50 x 24 mm  
**56-152** 55 x 24 mm  
**56-153** 60 x 24 mm  
**56-154** 65 x 24 mm  
**56-155** 70 x 24 mm  
**56-156** 75 x 24 mm  
Titanyum künt bleyd  
Blunt blades Titanium



**56-157** 25 x 19 mm  
**56-158** 30 x 19 mm  
**56-159** 35 x 19 mm  
**56-160** 40 x 19 mm  
**56-161** 45 x 19 mm  
**56-162** 50 x 19 mm  
**56-163** 55 x 19 mm  
**56-164** 60 x 19 mm  
Titanyum dişli bleyd  
Teeth blades titanium



**56-165** 25 x 19 mm  
**56-166** 30 x 19 mm  
**56-167** 35 x 19 mm  
**56-168** 40 x 19 mm  
**56-169** 45 x 19 mm  
**56-170** 50 x 19 mm  
**56-171** 55 x 19 mm  
**56-172** 60 x 19 mm  
Titanyum künt bleyd  
Blunt blades titanium



**56-173**  
Bleyd tutucu elçek  
Handle for blades with side load  
attachment







**56-174** 40 x 23 mm  
**56-175** 45 x 23 mm  
**56-176** 50 x 23 mm  
**56-177** 55 x 23 mm  
**56-178** 60 x 23 mm



**56-179** 40 x 23 mm  
**56-180** 45 x 23 mm  
**56-181** 50 x 23 mm  
**56-182** 55 x 23 mm  
**56-183** 60 x 23 mm



**56-184** 40 x 23 mm  
**56-185** 45 x 23 mm  
**56-186** 50 x 23 mm  
**56-187** 55 x 23 mm  
**56-188** 60 x 23 mm  
**56-189** 65 x 23 mm



**56-190** 40 x 25 mm  
**56-191** 45 x 25 mm  
**56-192** 50 x 25 mm  
**56-193** 55 x 25 mm  
**56-194** 60 x 25 mm



**56-195** 40 x 25 mm  
**56-196** 45 x 25 mm  
**56-197** 50 x 25 mm  
**56-198** 55 x 25 mm  
**56-199** 60 x 25 mm



**56-200** 30 x 24 mm  
**56-201** 35 x 24 mm  
**56-202** 40 x 24 mm  
**56-203** 45 x 24 mm  
**56-204** 50 x 24 mm  
**56-205** 55 x 24 mm  
**56-206** 60 x 24 mm  
**56-207** 65 x 24 mm  
**56-208** 70 x 24 mm  
**56-209** 75 x 24 mm

Titanyum bleyd Titanium blades



**56-210** 25 x 24 mm  
**56-211** 30 x 24 mm  
**56-212** 35 x 24 mm  
**56-213** 40 x 24 mm  
**56-214** 45 x 24 mm  
**56-215** 50 x 24 mm  
**56-216** 55 x 24 mm  
**56-217** 60 x 24 mm  
**56-218** 65 x 24 mm  
**56-219** 70 x 24 mm

Titanyum bleyd Titanium blades



**56-220** 25 x 24 mm  
**56-221** 30 x 24 mm  
**56-222** 35 x 24 mm  
**56-223** 40 x 24 mm  
**56-224** 45 x 24 mm  
**56-225** 50 x 24 mm  
**56-226** 55 x 24 mm  
**56-227** 60 x 24 mm  
**56-228** 65 x 24 mm  
**56-229** 70 x 24 mm

Titanyum bleyd Titanium blades

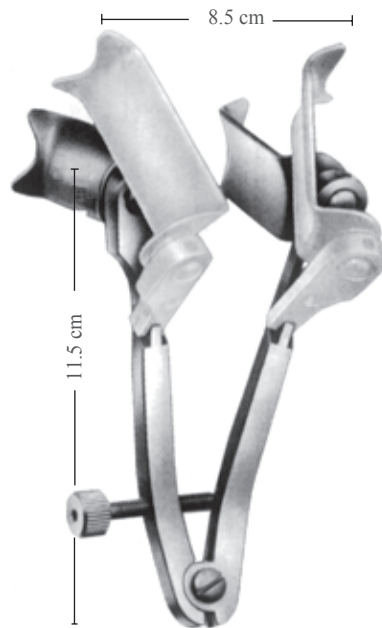


**56-230**  
Bleyd tutma pensi  
Blade ejector forceps  
11.5 cm

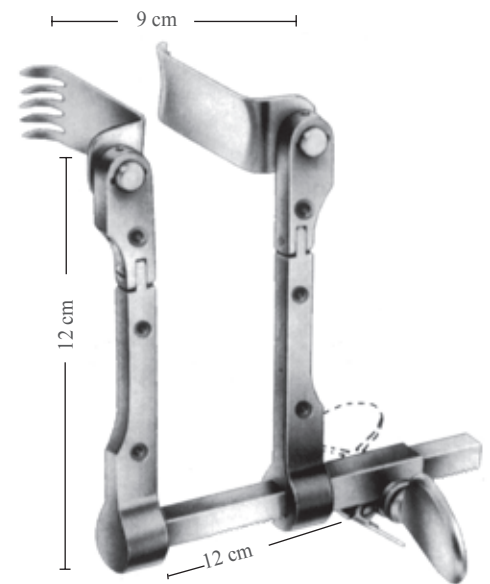
1/2



CASPAR  
**56-231**

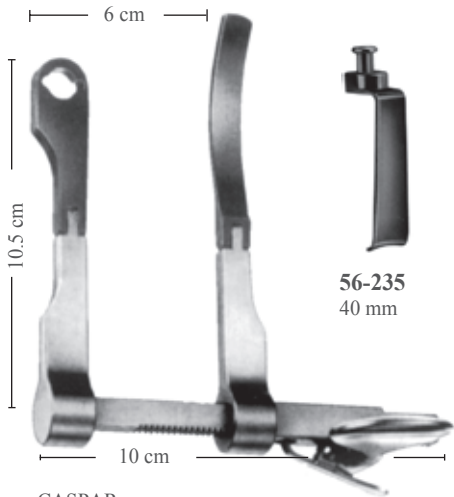


CASPAR  
**56-232**



CASPAR  
**56-233**

HardCoated



CASPAR  
56-234 Komple/Complete

56-235  
40 mm

56-236  
45 mm

56-237  
50 mm

56-238  
55 mm

56-239  
60 mm

56-240  
65 mm

56-241  
70 mm

HardCoated



56-242  
35 mm

56-243  
40 mm

56-244  
45 mm

56-245  
50 mm

56-246  
55 mm

56-247  
60 mm

56-248  
65 mm

56-249  
75 mm

56-250  
85 mm



56-251  
40 mm

56-252  
45 mm

56-253  
50 mm

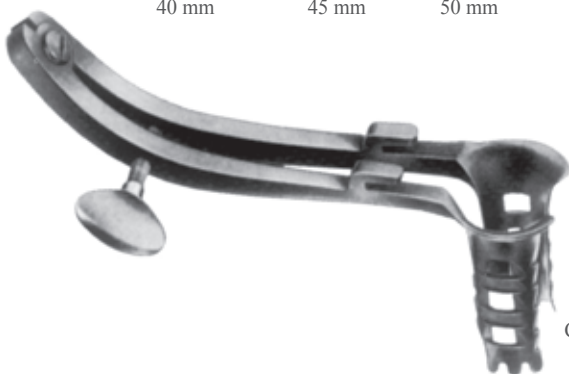
56-254  
55 mm

56-255  
60 mm

56-256  
65 mm

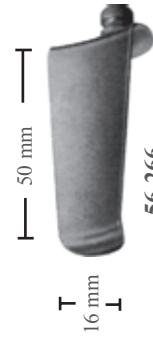
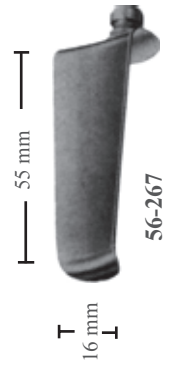
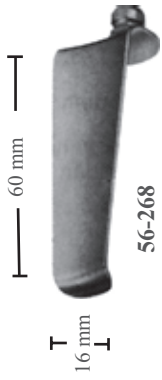
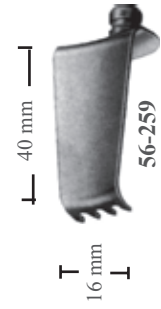
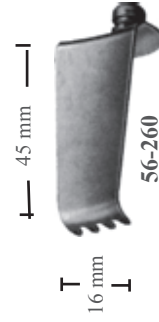
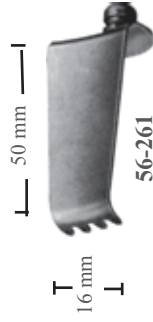
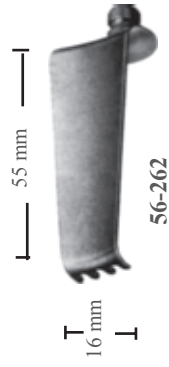
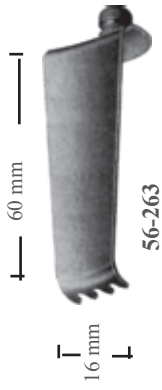
56-257  
75 mm

56-258  
85 mm



CASPAR





11 cm



CLOWARD  
**56-269**  
Sadece ekartör  
Retractor only  
25 cm



CLOWARD  
**56-270**  
Sadece ekartör  
Retractor only  
15 cm

CLOWARD  
**56-271** Komple/Complete



**56-272** 38 mm  
**56-273** 58 mm  
Pimsiz/Without pins



**56-274** 32 x 22 mm  
**56-275** 37 x 22 mm  
**56-276** 42 x 22 mm  
**56-277** 47 x 22 mm  
**56-278** 52 x 22 mm  
**56-279** 57 x 22 mm  
**56-280** 62 x 22 mm  
**56-281** 67 x 22 mm  
Pimsiz/Without pins



**56-282** 32 x 37 mm  
**56-283** 37 x 37 mm  
**56-284** 42 x 37 mm  
**56-285** 47 x 37 mm  
**56-286** 52 x 37 mm  
**56-287** 57 x 37 mm  
**56-288** 62 x 37 mm  
**56-289** 67 x 37 mm  
Pimsiz/Without pins



**56-290** 32 x 52 mm  
**56-291** 37 x 52 mm  
**56-292** 42 x 52 mm  
**56-293** 47 x 52 mm  
**56-294** 52 x 52 mm  
**56-295** 57 x 52 mm  
**56-296** 62 x 52 mm  
**56-297** 67 x 52 mm  
Pimsiz/Without pins



CASPAR

**56-298**  
Sadece ekartör  
Retractor only



SCOVILLE  
**56-299** 55 mm



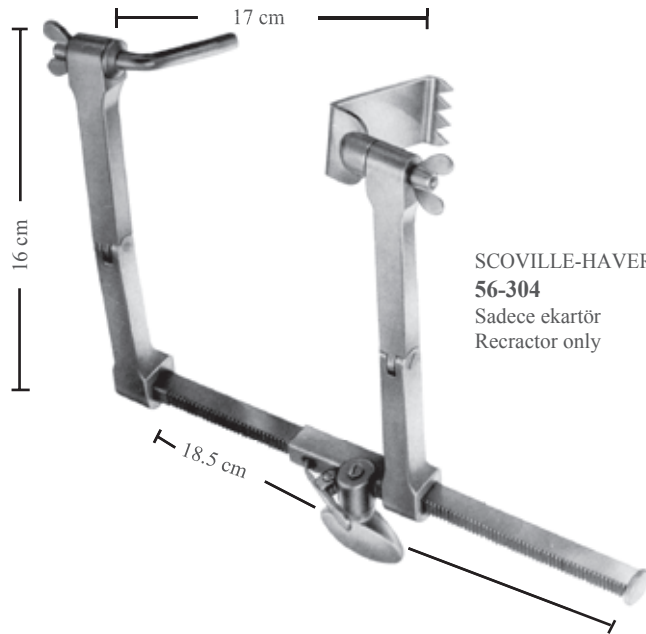
SCOVILLE  
**56-300** 63 x 25 mm  
**56-301** 63 x 51 mm



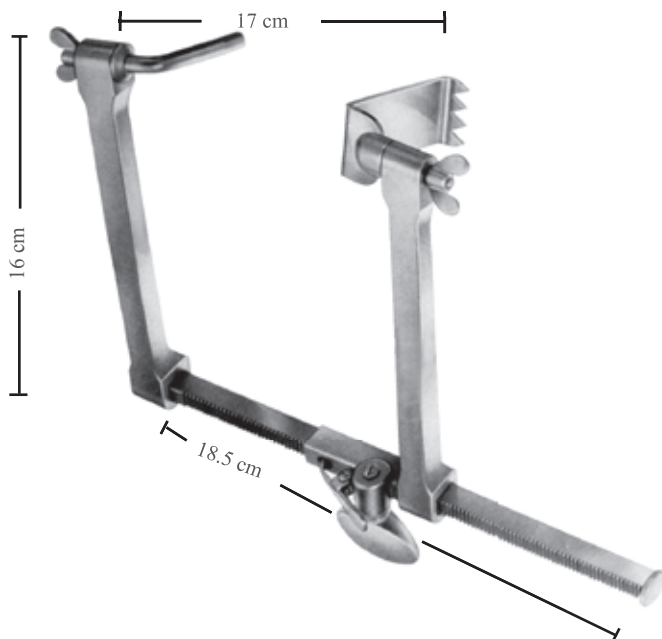
TAYLOR  
**56-302** 47 x 37 mm



TAYLOR  
**56-303** 62 x 52 mm



SCOVILLE-HAVERFIELD  
**56-304**  
Sadece ekartör  
Retractor only



SCOVILLE  
**56-305** Komple/Complete





**56-306** 48 mm  
**56-307** 60 mm



**56-308** 48 x 30 mm  
**56-309** 60 x 30 mm



**56-310** 48 x 50 mm  
**56-311** 60 x 50 mm



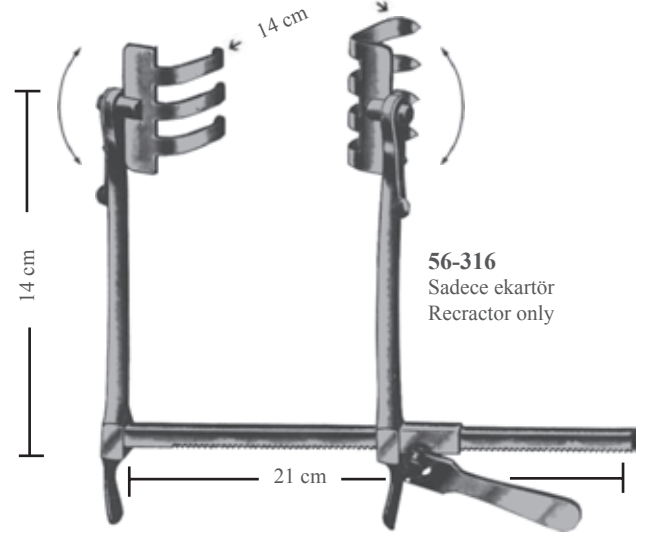
**56-312** 48 x 50 mm  
**56-313** 60 x 50 mm



**56-314** 38 x 62 mm



**56-315** 28 x 40 mm



**56-316**  
Sadece ekartör  
Retractor only

SCOVILLE-RICHTER  
**56-317** Komple/Complete



**56-318** 62 x 37 mm



**56-319** 62 x 52 mm



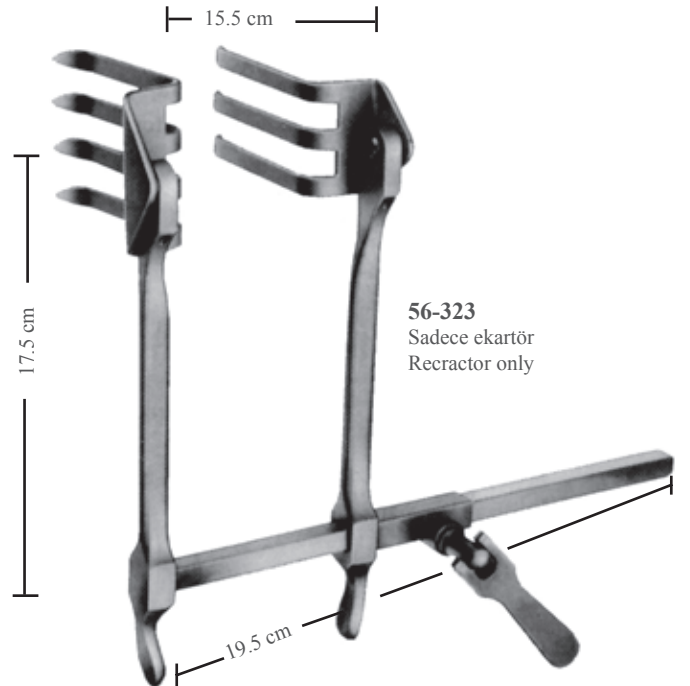
**56-320** 47 x 51 mm



**56-321** 30 x 40 mm



**56-322** 37 x 62 mm



**56-323**  
Sadece ekartör  
Retractor only

SCOVILLE-RICHTER  
**56-324**





**BABY-COLLIN**  
**56-325** Komple/Complete  
**56-326** Sadece ekartör  
 Retractor only  
**56-327** 18 x 42 mm bleyd çift/blades pair  
**56-328** 28 x 42 mm bleyd çift/blades pair



**COLLIN**  
**56-329** Komple/Complete  
**56-330** Sadece ekartör  
 Retractor only  
**56-331** Yan bleyd çift  
 Lateral blades pair



**COLLIN**



**COLLIN**

Sadece ekartör Retractor only	<b>56-332</b> <b>56-335</b>	<b>56-333</b> <b>56-336</b>	<b>56-334</b> <b>56-337</b>
Yan bleyd (çift) Lateral blades (pair)	<b>56-338</b> 37 x 62 mm	<b>56-339</b> 37 x 80 mm	<b>56-340</b> 37 x 98 mm
Orta bleyd Center blade	<b>56-341</b> 54 x 55 mm	<b>56-342</b> 54 x 67 mm	<b>56-343</b> 52 x 76 mm

Sadece ekartör Retractor only	<b>56-344</b> <b>56-346</b>	<b>56-345</b> <b>56-347</b>
Yan bleyd (çift) Lateral blades (pair)	48 x 59 mm <b>56-348</b> 63 x 74 mm	61 x 80 mm <b>56-349</b> 63 x 74 mm
Orta bleyd Center blade		



32 cm



RICARD

Sadece ekartör  
Retractor only  
Yan bleyd (çift)  
Lateral blades (pair)  
Orta bleyd  
Center blade

**56-350**  
**56-352**

**56-354**  
58 x 80 mm  
**56-356**  
54 x 70 mm

**56-351**  
**56-353**

**56-355**  
72 x 84 mm  
**56-357**  
72 x 90 mm

26.5 cm



ROBIN-MASSE  
**56-358**  
Komple/Complete

Sadece ekartör  
Retractor only  
Yan bleyd (çift)  
Lateral blades (pair)  
Orta bleyd  
Center blade

**56-359**

**56-360**  
37 x 62 mm  
**56-361**  
38 x 68 mm

27.5 cm



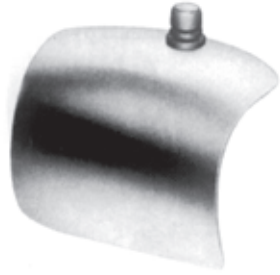
HOLZBACH  
**56-362**  
Komple/Complete

Sadece ekartör  
Retractor only  
Yan bleyd (çift)  
Lateral blades (pair)  
Orta bleyd  
Center blade

**56-363**

**56-364**  
59 x 80 mm  
**56-365**  
74 x 82 mm





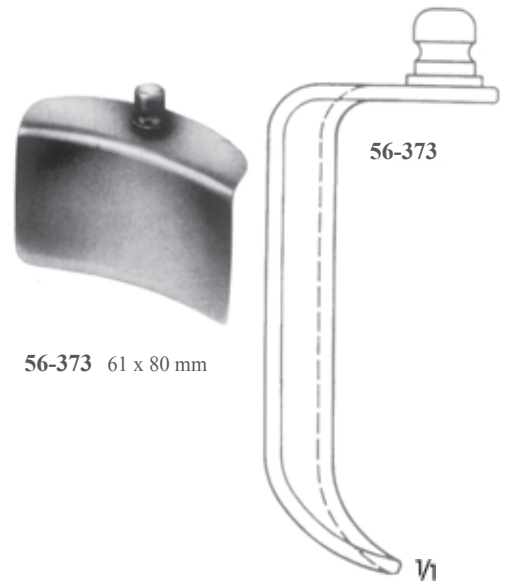
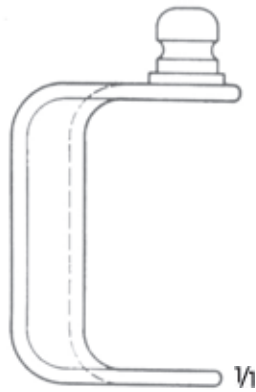
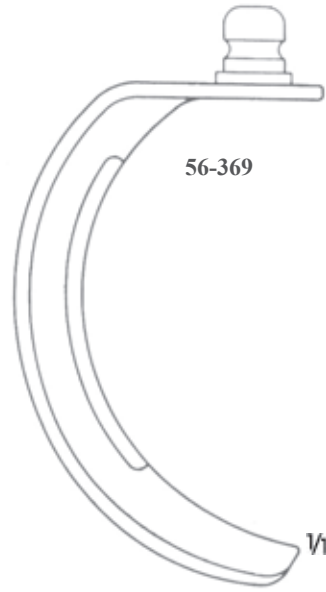
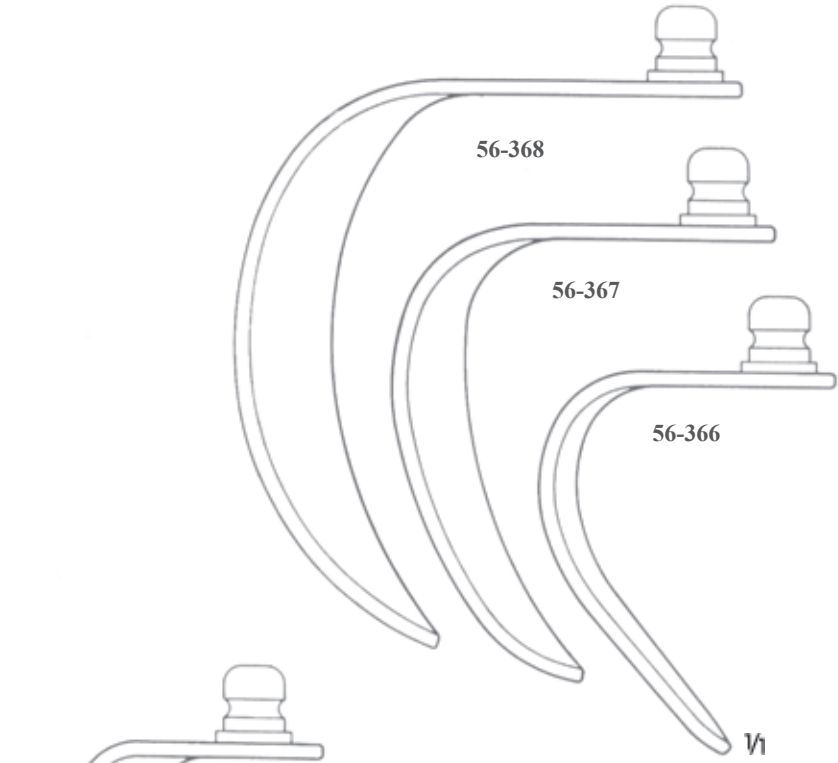
**56-366** 48 x 59 mm  
**56-367** 58 x 80 mm  
**56-368** 72 x 84 mm  
Yan bleyd (çift) Lateral  
blades (pair)

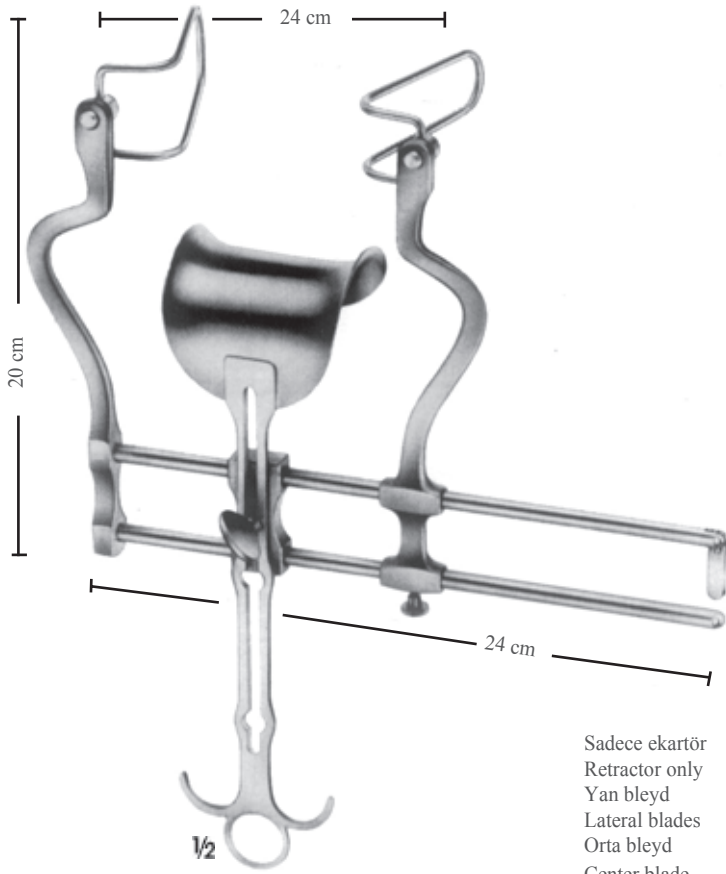


**56-369** 59 x 80 mm  
Yan bleyd (çift) Lateral  
blades (pair)



**56-370** 37 x 62 mm  
**56-371** 37 x 80 mm  
**56-372** 37 x 98 mm  
Yan bleyd (çift) Lateral  
blades (pair)

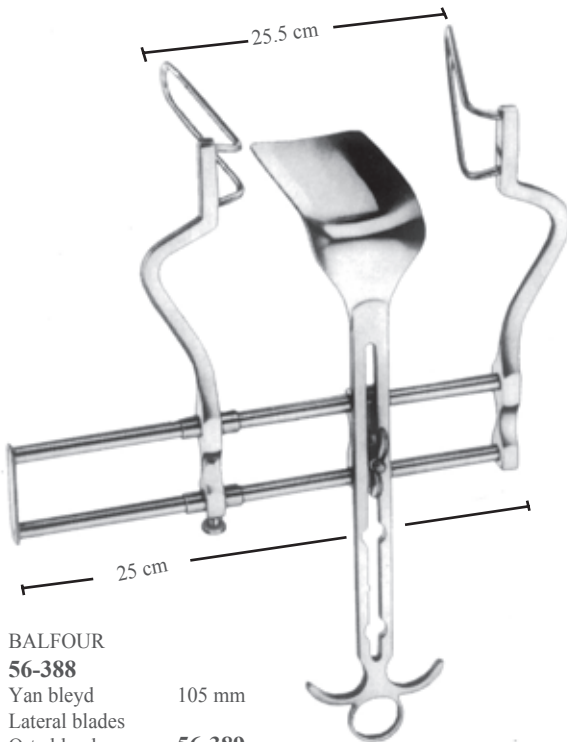




56-380 50 mm  
56-381 60 mm ,  
56-382 75 mm  
56-383 90 mm  
Yan Bleyd/Lateral Blades

BALFOUR  
56-374  
Komple/Complete

Sadece ekartör Retractor only	56-375	56-376	56-377	56-378
Yan bleyd Lateral blades	56-379	56-379	56-379	56-379
Orta bleyd Center blade	56-380 50 mm	56-381 60 mm	56-382 75 mm	56-383 90 mm
	56-384 47 x 80 mm	56-385 62 x 76 mm	56-386 80 x 80 mm	56-387 80 x 80 mm



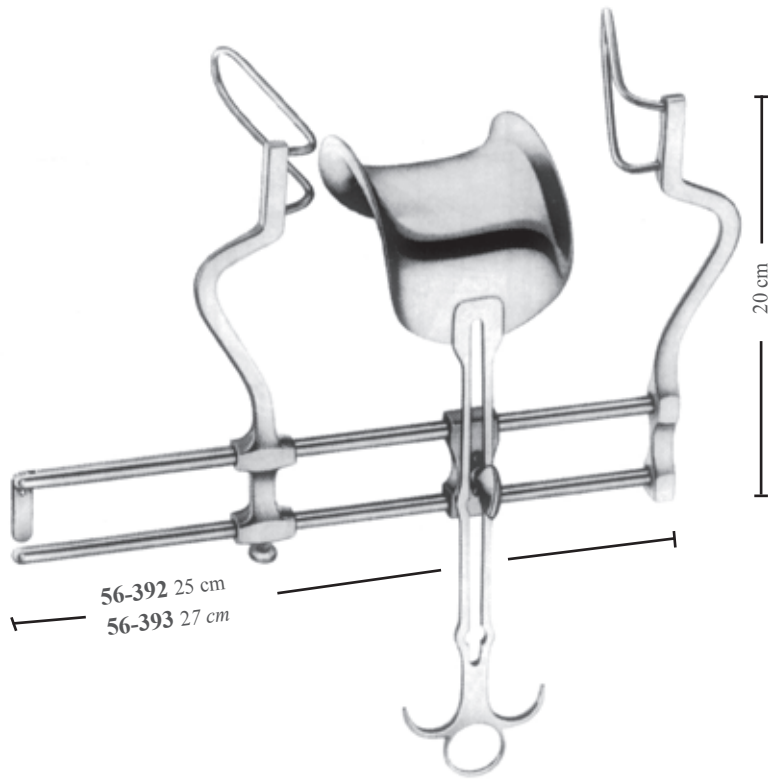
BALFOUR  
56-388  
Yan bleyd 105 mm  
Lateral blades  
Orta bleyd 56-389  
Center blade 107 x 59 mm



56-390  
Orta bleyd  
Center blade  
54 x 80 mm

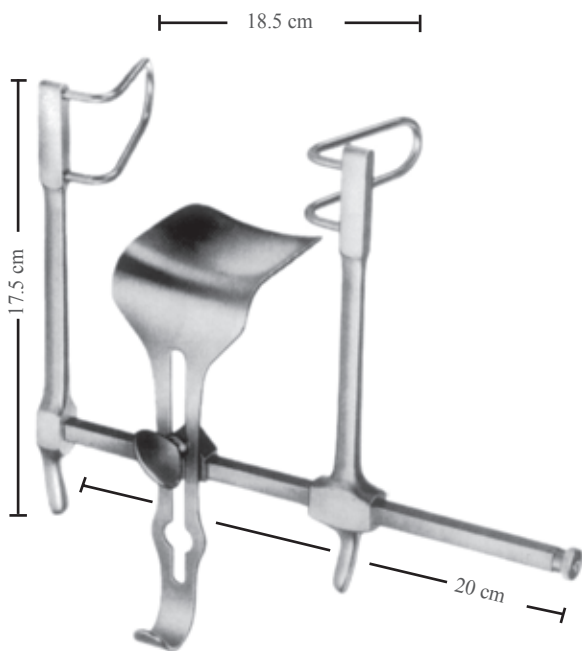


56-391  
Orta bleyd, prostatektomi için kanallı 75 x 80 mm  
Center blade, slotted for retropubic prostatectomy  
75 x 80 mm

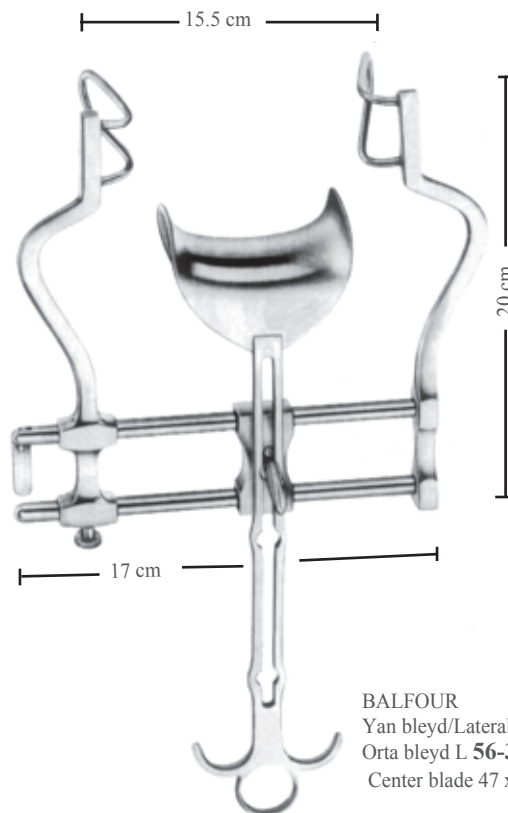


BALFOUR

	<b>56-394</b>	<b>56-395</b>
Yan bleyd Lateral blades	60 mm	90 mm
Orta bleyd Center blade	<b>56-396</b> 62 x 76 mm	<b>56-397</b> 80 x 80 mm

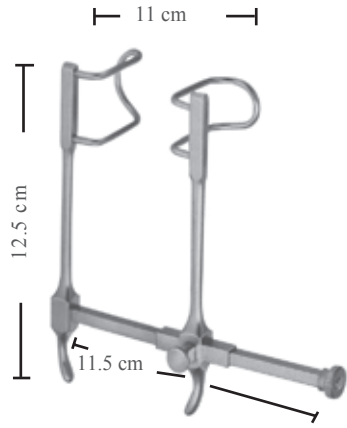


GOSSET  
**56-398**  
Yan bleyd/Lateral blades 58 mm  
Orta bleyd  
Center blade 59 x 57 mm

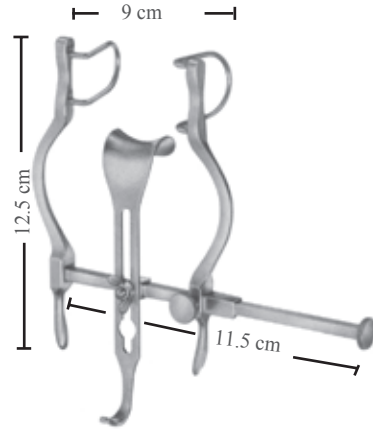


BALFOUR  
Yan bleyd/Lateral blades 60 mm  
Orta bleyd L **56-399**  
Center blade 47 x 80 m





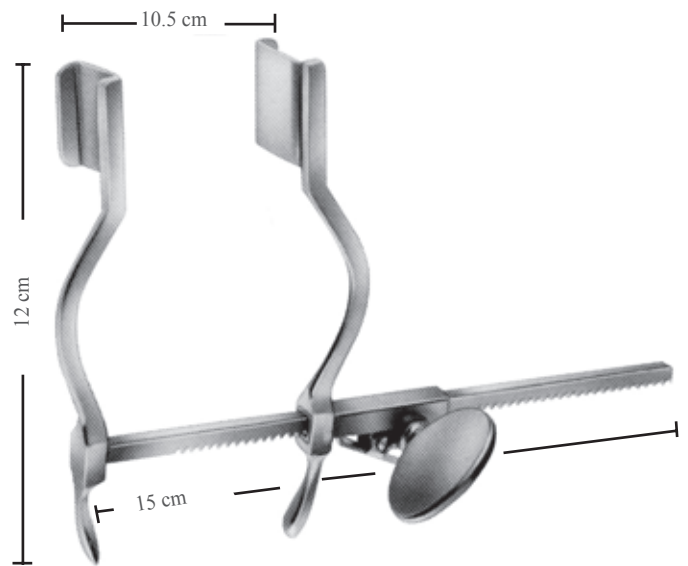
GOSSET  
**56-400** Bleyd/  
Blades 38 mm



BALFOUR-BABY  
**56-401**  
Yan bleyd/Lateral blades 27 mm  
Orta bleyd  
Center blade 21 x 24 mm



GOSSET  
**56-402**  
Bleyd/Blades 55 mm

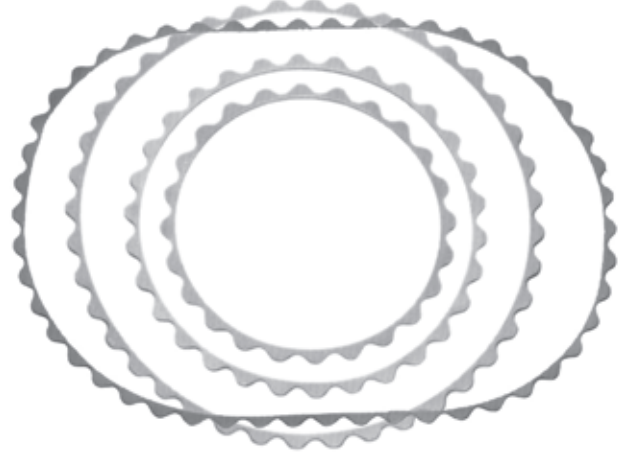


HERTZLER  
**56-403**  
Bleyd/Blades  
20 x 25 mm





TURNER-WARWICK  
**56-404** Komple/Complete  
**56-405** 1 adet/1 each  
**56-406** 1 adet/1 each  
**56-407** 2 adet/2 each  
**56-408** 2 adet/2 each  
**56-409** 2 adet/2 each  
**56-410** 2 adet/2 each  
**56-411** 2 adet/2 each  
**56-412** 2 adet/2 each  
**56-413** 2 adet/2 each



TURNER-WARWICK  
**56-405** Ø 18 cm  
**56-406** Ø 23 cm  
**56-407** Ø 30.5 cm  
Ekartör çemberi, yuvarlak  
Retractor frame, round  
**56-408**  
Ekartör çemberi, oval  
Retractor frame, oval  
457 x 330 mm



**56-409** Bükülebilir/  
Malleable 76 x 19 mm



**56-410** Bükülebilir/  
Malleable 102 x 38 mm



**56-411** Bükülebilir/  
Malleable 89 x 57 mm



**56-412** Bükülebilir/  
Malleable 114 x 57 mm



**56-413**  
13 mm



**56-414**  
51 x 38 mm



**56-415**  
76 x 60 mm



**56-416**  
89 x 60 mm



**56-417**  
114 x 60 mm





Sadece ekartör  
Retractor only

**56-417** O'SULLIVAN-O' CONNOR  
**56-418** Komple/Complete  
**56-419**  
**56-420** (2 adet)**56-421** (1 adet)



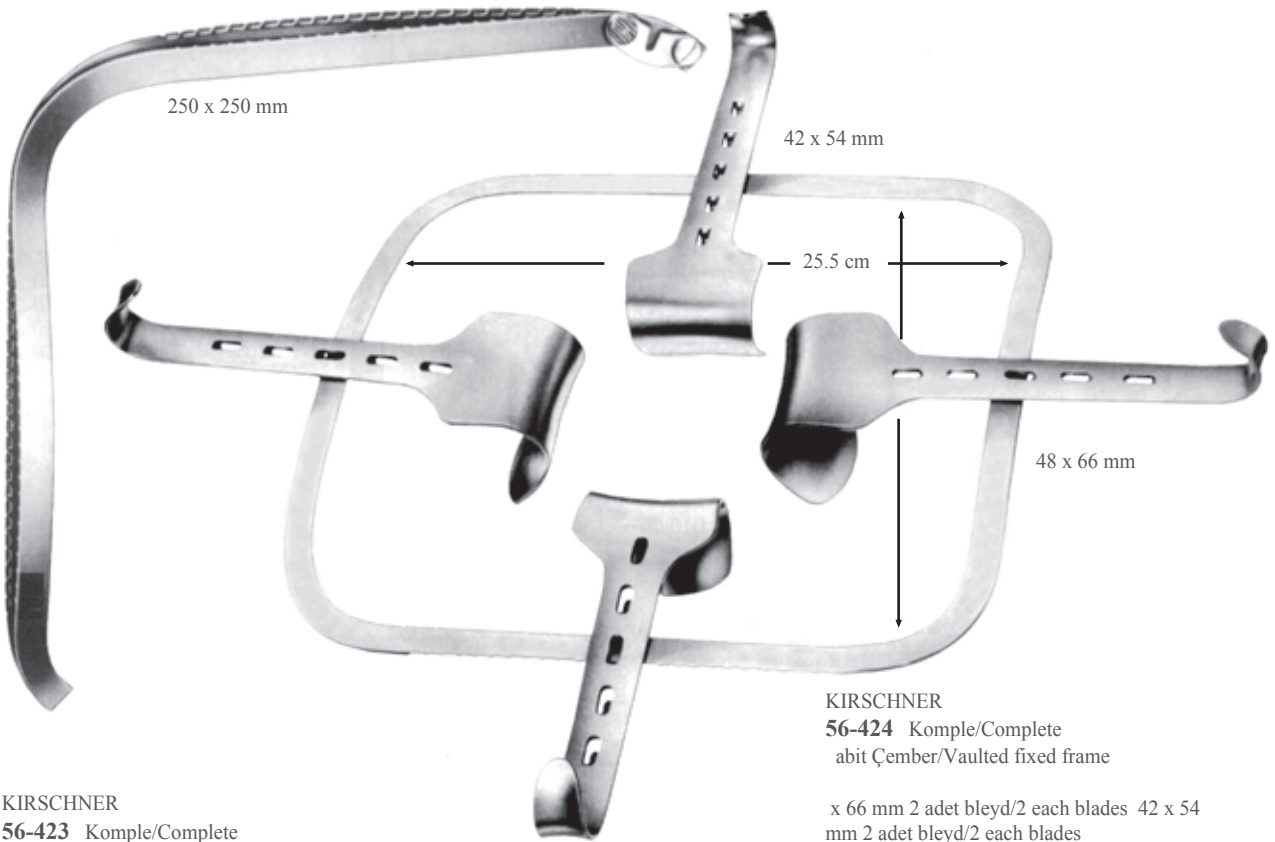
O'SULLIVAN-O' CONNOER  
**56-420**  
Küçük bleyd/Small blade



O'SULLIVAN-O' CONNOER  
**56-421**  
Büyük bleyd/Large blade



GOLIGHER  
**56-422**  
Komple/Complete  
Orta bleyd/Center blade 51 mm  
Orta bleyd/Center blade 102 mm  
Yan bleyd(bir çift)/Lateral blades(pair) 51 mm  
Yan bleyd(bir çift)/Lateral blades(pair) 102 mm



KIRSCHNER  
**56-423** Komple/Complete  
Katlanabilir/Holding frame  
48 x 66 mm 2 adet bleyd/2 each blades  
42 x 54 mm 2 adet bleyd/2 each blades

KIRSCHNER  
**56-424** Komple/Complete  
abit Çember/Vaulted fixed frame

x 66 mm 2 adet bleyd/2 each blades 42 x 54  
mm 2 adet bleyd/2 each blades

**56-425** 275 x 355 mm  
Büyük ölçekli çember  
Frame only, over-sized

**56-426** 295 x 275 mm  
Sadece Çember/Frame only



KIRSCHNER  
**56-427**  
64 x 80 mm



KIRSCHNER-BALFOUR  
**56-428**  
80 x 82 mm

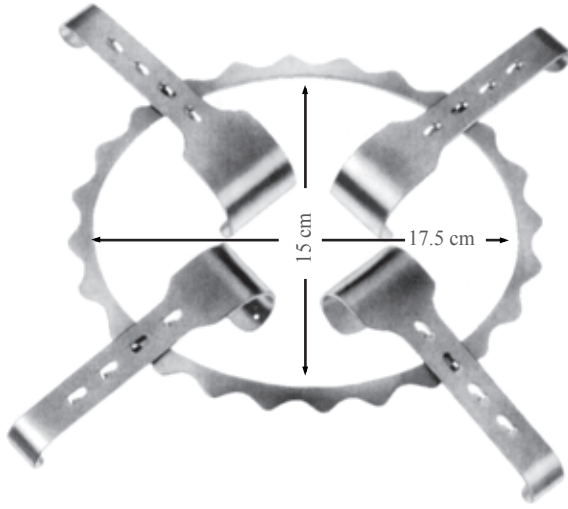


KIRSCHNER  
**56-429** 90 x 69 mm  
**56-430** 95 x 95 mm  
**56-431** 78 x 58 mm



KIRSCHNER  
**56-432** 108 x 42 mm  
**56-433** 91 x 55 mm  
**56-434** 120 x 55 mm





DENNIS-BROWNE

**56-435**

Komple/Complete

56-436	175 x 150 mm	Çember/Frame
56-437	40 x 30 mm	2 adet bleyd/2 each blades
56-438	40 x 40 mm	2 adet bleyd/2 each blades



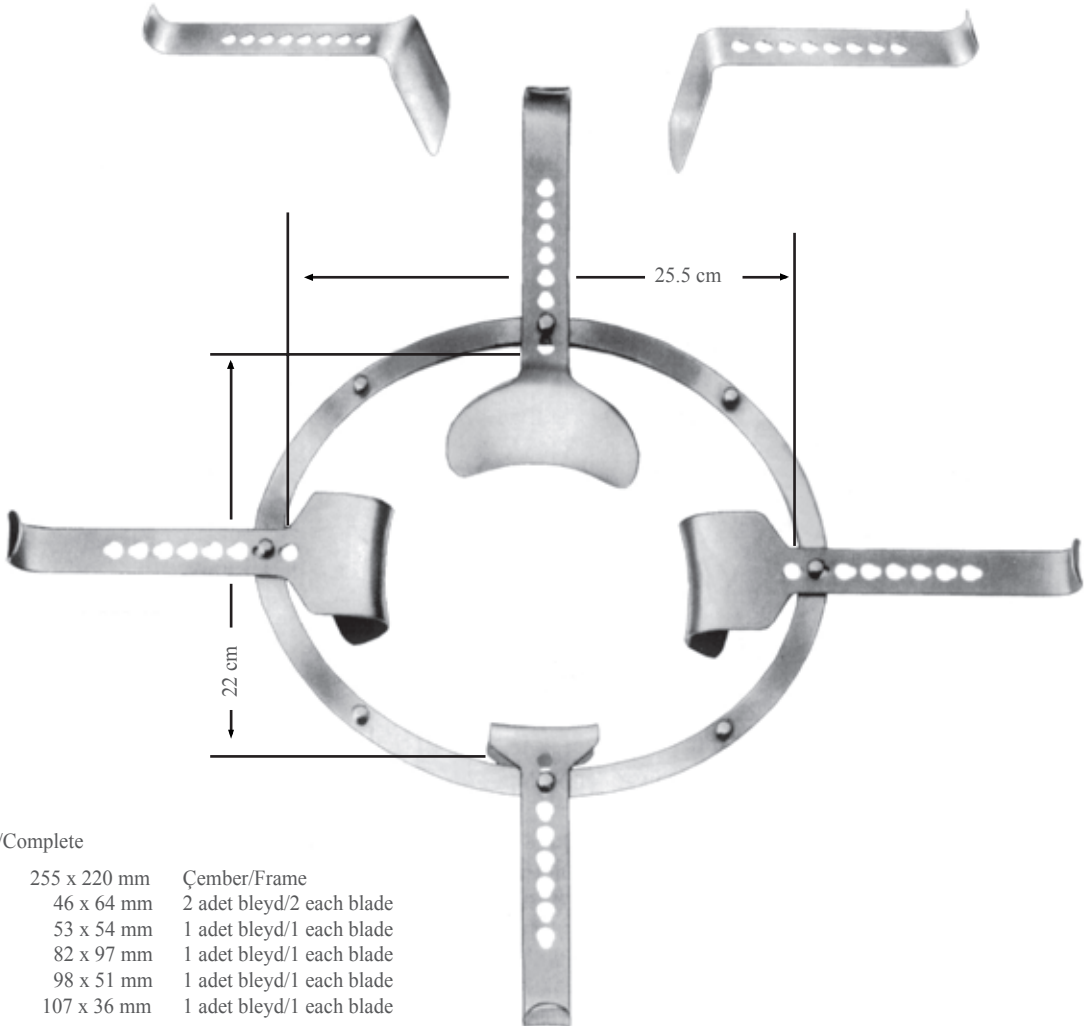
**56-439**

1 adet bleyd  
1 each blade  
20 x 30 mm



**56-440**

1 adet bleyd  
1 each blade  
20 x 40 mm



SEMM

**56-442**

Komple/Complete

56-443	255 x 220 mm	Çember/Frame
56-444	46 x 64 mm	2 adet bleyd/2 each blade
56-445	53 x 54 mm	1 adet bleyd/1 each blade
56-446	82 x 97 mm	1 adet bleyd/1 each blade
56-447	98 x 51 mm	1 adet bleyd/1 each blade
56-448	107 x 36 mm	1 adet bleyd/1 each blade





ALLENBERG  
**56-451**  
Yan Bleyd/Lateral Blade  
Titanyum/Titanium  
30 x 30 mm



ALLENBERG  
**56-452**  
Orta Bleyd/Medial Blade  
Titanyum/Titanium  
90 x 60 mm



ALLENBERG  
**56-453**  
Bleyd deęiřtirmek için penset  
Forceps for changing the blades  
13 cm



ALLENBERG  
**56-449**  
Sadece ekartör  
Retractor only

ALLENBERG  
**56-450**  
İliak ekartörü komple  
Iliaca retractor complete  
56-449 Sadece ekartör/Retractor only  
56-451 Yan Bleyd/Lateral Blade 30 x 30 mm  
56-452 Orta Bleyd/Medial Blade 90 x 60 mm



**56-454** Komple/Complete Popliteal Ekartör/Popliteal Retractor

**56-455** Sadece ekartör/Retractor only

- 56-456** Bleyd çift, küt 60 x 50 mm  
Blades pair blunt 60 x 50 mm  
Bleyd çift, yarı sivri, 40 x 35 mm  
Blades pair semi-sharp 40 x 35 mm

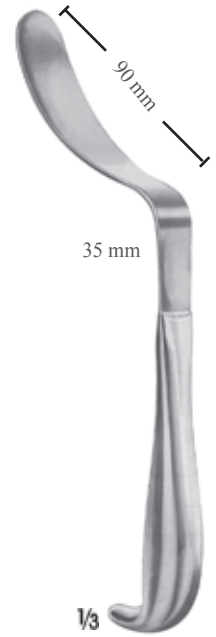


L 515.06  
82 x 25 mm

MILLIN

**56-457** Komple/Complete Mesane Ekartörü/Bladder Retractor

- 56-458** Sadece ekartör/Retractor only  
**56-459** Bleyd 57 x 25 mm/Blades 57 x 25 mm  
**56-460** Bleyd 82 x 25 mm/Blades 82 x 25 mm  
**56-461** Orta bleyd 105 x 45 mm  
Center blade 105 x 45 mm



35 mm

1/3

LEGUEU

**56-462** Mesane spatulası  
Bladder spatula  
26 cm



**56-456**  
60 x 50 mm



**56-463**  
40 x 35 mm

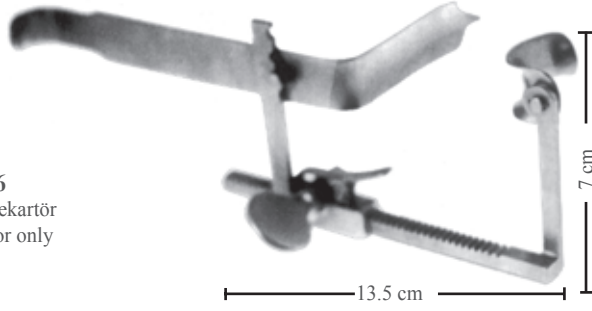


**56-464**  
57 x 25 mm

TAYLOR-TURANTAN

**56-465**  
20 x 68 x 150 mm

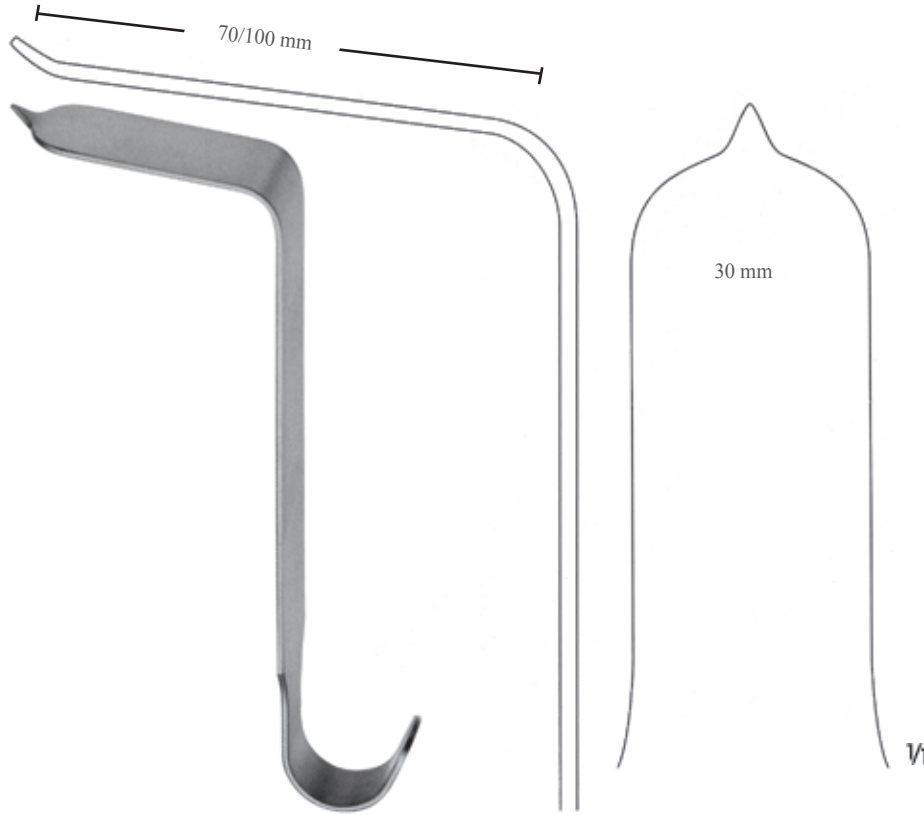
**56-466**  
Sadece ekartör  
Retractor only



**56-468** 20 x 20 mm  
**56-469** 30 x 20 mm  
**56-470** 36 x 20 mm

TURANTAN

**56-467** Komple/Complete



TAYLOR  
**56-471**  
Bleyd boyu/Blade Size 30 x 70 mm  
18.5 cm  
**56-472**  
Bleyd boy/Blade Size 30 x 100 mm  
20 cm

BALLANTINE  
**56-473**  
32 x 90 mm  
23 cm





1/2

TROUSSEAU  
**56-474**  
Trakeal dilatör  
Tracheal dilator  
12 cm



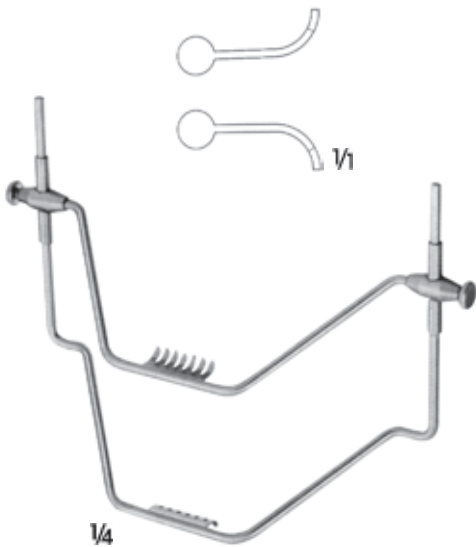
1/2

LABORDE  
**56-475**  
Trakeal dilatör  
Tracheal dilator  
12.5 cm



1/2

LABORDE  
**56-476**  
Trakeal dilatör/Güçlü model  
Tracheal dilator/Strong pattern  
13.5 cm



1/4

**56-477**  
Tiroid ekartörü  
Thyroid retractor



1/2

JOLL (FRIEDMANN)  
**56-478**  
Tiroid ve vajinal ekartör  
Thyroid and vaginal retractor  
15.5 cm



1/2

DE BAKEY  
**56-479**  
Kalça kemiği ekartörü, çocuk için  
Femur retractor for children  
10 cm



1/2

GELPI  
**56-480**  
Vajinal ekartör  
Vaginal retractor  
13.5 cm



1/2

DE BAKEY  
**56-481**  
Kalça kemiği ekartörü  
Femur retractor  
14.5 cm



1/2

GELPI  
**56-482**  
Cilt ve vajinal ekartör  
Skin and vaginal retractor  
17.5 cm



1/2

JACKSON-BURROWS  
**56-483**  
Ekartör, künt/Retractor, blunt  
18.5 cm



1/2

RICHTER  
**56-484**  
17 cm





1/2  
**56-485**  
17 cm



**56-486** Sağ/Right  
18 cm



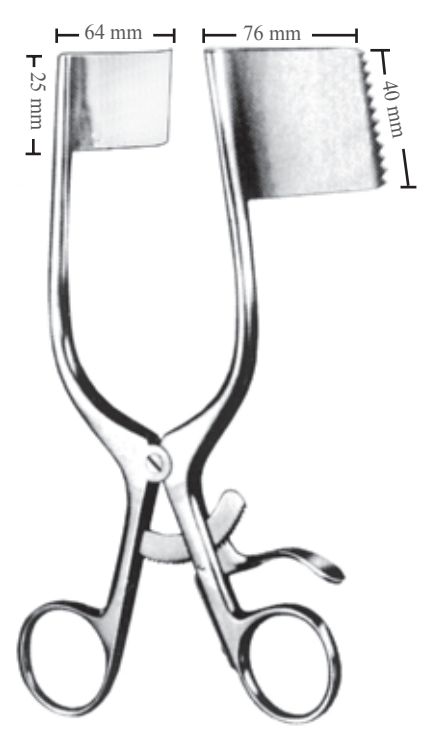
**56-487** Sol/Left  
18 cm



1/2  
**MEYERDING**  
**56-488** 25 x 40 mm  
**56-489** 25 x 50 mm  
**56-490** 25 x 60 mm  
17 cm



**DARLING**  
**56-491**  
18 cm



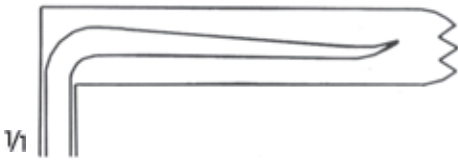
**DARLING**  
**56-492**  
18 cm



MEYERDING  
18 cm

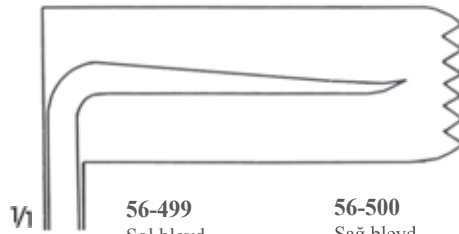


MEYERDING  
18 cm



**56-493**  
Sol bleyd  
Left blade

**56-494**  
Sağ bleyd  
Right blade



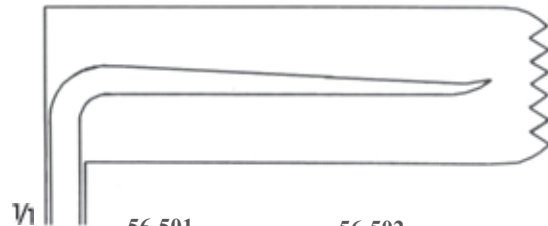
**56-499**  
Sol bleyd  
Left blade

**56-500**  
Sağ bleyd  
Right blade



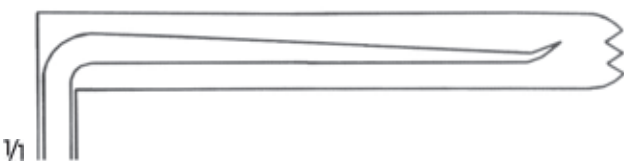
**56-495**  
Sol bleyd  
Left blade

**56-496**  
Sağ bleyd  
Right blade



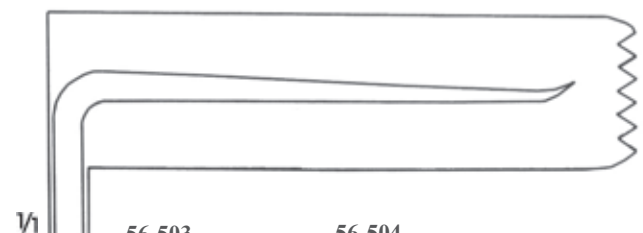
**56-501**  
Sol bleyd  
Left blade

**56-502**  
Sağ beyd  
Right blade



**56-497**  
Sol bleyd  
Left blade

**56-498**  
Sağ bleyd  
Right blade



**56-503**  
Sol bleyd  
Left blade

**56-504**  
Sağ bleyd  
Right blade







WEITLANER  
**56-505** Sivri/Sharp  
**56-506** Künt/Blunt  
18 cm

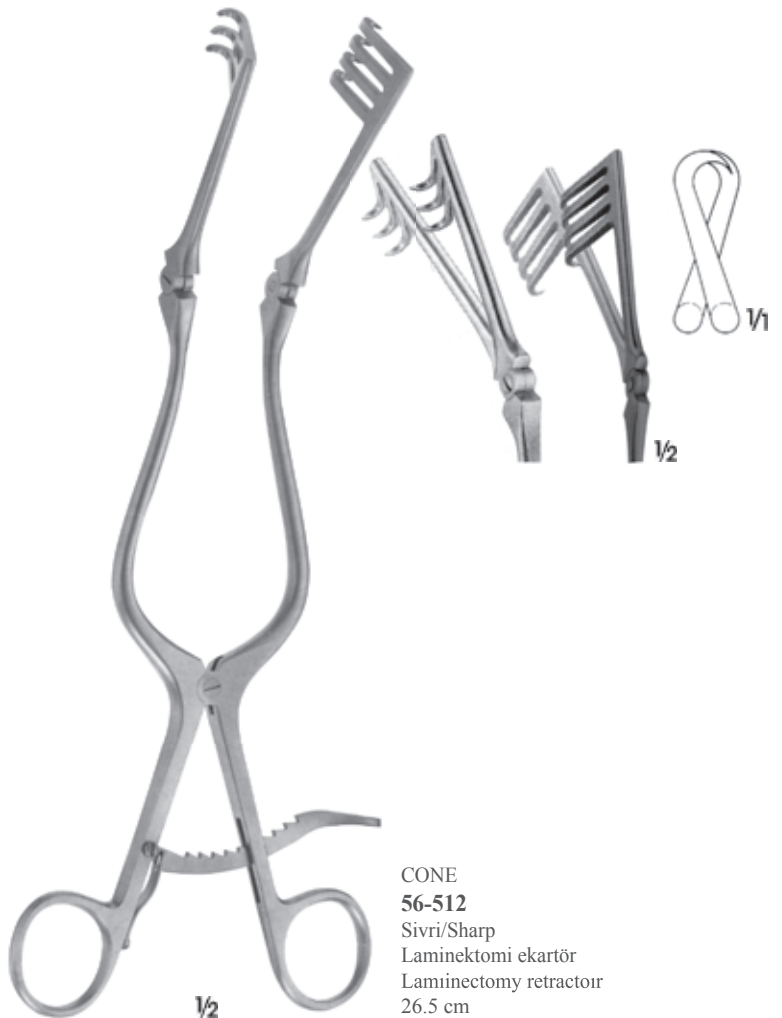


**56-507**  
Sadece ekartör/Retractor only  
Künt/Blunt  
17 cm

ALLENBERG  
**56-508** Komple/Complete  
**56-509** Sadece ekartör, künt  
Retractor only, blunt 17 cm  
**56-510** Bleyd/Blade 12 cm 35  
x 10 mm - 20 x 12 mm Karotis  
ekartör/Carotid retractor system



TRAVERS  
**56-511**  
Künt/Bulunt  
Laminektomi ekartör  
Laminectomy retractor  
21.5 cm



CONE  
**56-512**  
Sivri/Sharp  
Laminektomi ekartör  
Laminectomy retractor  
26.5 cm

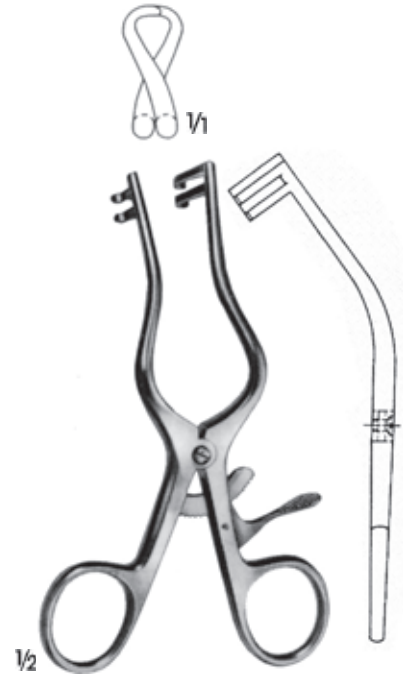




MOLLISON  
**56-513** Sivri/Sharp  
14 cm



PLESTER  
**56-514** Sivri/Sharp  
13 cm



PLESTER  
**56-515** Künt/Blunt  
13 cm



MAYO-ADAMS  
**56-516**  
16.5 cm



TÜBINGER  
**56-517**  
16.5 cm



IRWIN  
**56-518** Sivri/Sharp  
17.5 cm





**1/2**  
PLESTER  
**56-519** Künt/Blunt  
Sol/Left  
11 cm



**1/2**  
PLESTER  
**56-520** Künt/Blunt  
Sağ/Right  
11 cm



**1/2**  
HENDERSON  
**56-521** Sivri/Sharp  
18 cm



**1/2**  
ADSON-BABY  
**56-522** 14 cm  
**56-523** 16 cm  
Yarı sivri/Semi sharp



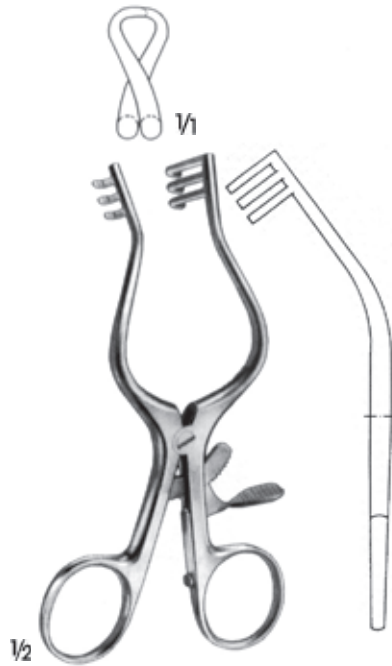
**1/2**  
ADSON  
**56-524** Sivri/Sharp  
**56-525** Künt/Blunt  
16 cm



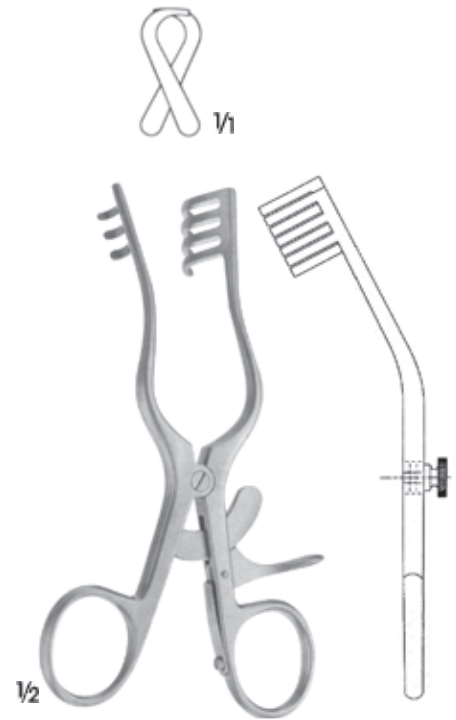
**1/2**  
ADSON  
**56-526** Sivri/Sharp  
**56-527** Künt/Blunt  
20 cm



WULLSTEIN  
56-528 Sivri/Sharp  
13 cm



WULLSTEIN  
56-529 Künt/Blunt  
13 cm



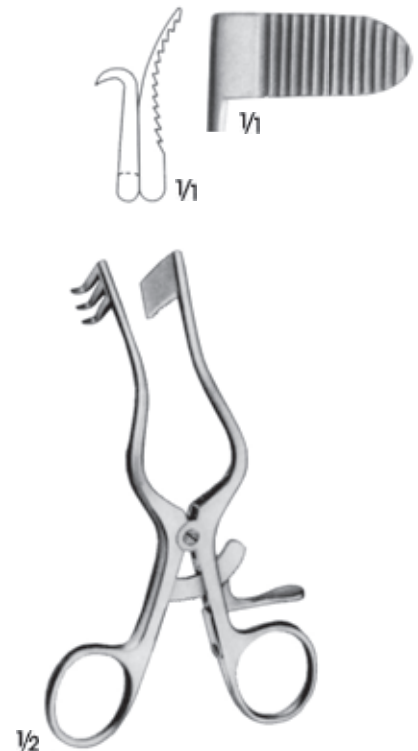
JEFFERSON  
56-530 Künt/Blunt  
Eğri/Curved  
14 cm



RNTNE  
56-531 Sivri/Sharp  
16.5 cm



PERKINS  
56-532  
13 cm



PERKINS  
56-533  
13 cm





V1



1/2

WEITLANER  
56-534 Sivri/Sharp  
11 cm



V1



1/2

WEITLANER  
56-535 Künt/Blunt  
11 cm



V1



1/2

WEITLANER  
56-536 Yarı Sivri/Semi-sharp  
11 cm



V1



1/2

WEITLANER  
56-537 Sivri/Sharp  
13 cm



V1



1/2

WEITLANER  
56-538 Künt/Blunt  
13 cm



V1



1/2

WEITLANER  
56-539 Yarı sivri/Semi-sharp  
13 cm



WEITLANER  
**56-540** Sivri/Sharp  
13 cm



WEITLANER  
**56-541** Künt/Blunt  
13 cm



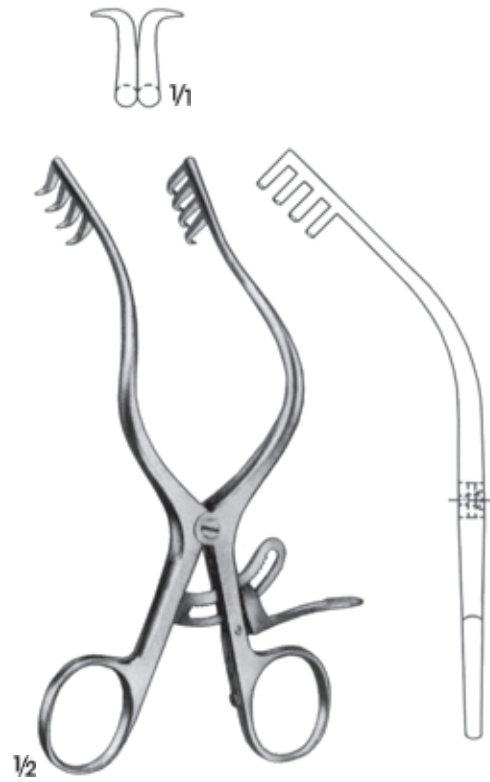
WEITLANER  
**56-542** Sivri/Sharp  
16.5 cm



WEITLANER  
**56-543** Künt/Blunt  
16.5 cm



WEITLANER  
**56-544** Yarı sivri/Semi-sharp  
16.5 cm



MOLLISON  
**56-545** Sivri/Sharp  
15.5 cm





1/2

SAUER  
56-546  
3.5 cm



1/2

LANCASTER  
56-547  
8 cm



1/2

LOGAN  
56-548  
5 cm



1/2

FINSEN  
56-549  
5 cm



1/2

FINSEN  
56-550  
7 cm



1/2

56-551  
4.5 cm



1/2

56-552  
5.5 cm



1/2

PARSONNET  
56-553  
5 cm



1/2

BARRAQUER  
56-554  
4.5 cm



1/2

BOSE  
56-555  
6 cm



1/2

**56-556**  
Otomatik ekartör  
Self-retaining retractor  
12 cm



1/2

**ALLPORT**  
**56-557**  
9.5 cm



1/2

**JANSEN**  
**56-558** Sivri/Sharp  
10 cm



1/2

**JANSEN**  
**56-559**  
10 cm



1/2

**JANSEN**  
**56-560**  
10 cm



1/2

**FINZEN**  
**56-561**  
7.5 cm



1/2

**FINZEN**  
**56-562**  
7 cm



1/2

**56-563**  
Künt/Blunt 10 cm



1/2

**56-564**  
Sivri/Sharp  
10 cm



**ALM**  
**56-565** 7 cm



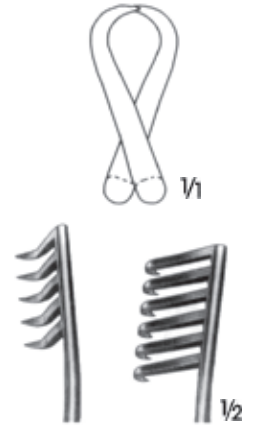




**56-566**  
Sivri/Sharp  
19.5 cm



**56-567**  
Sivri/Sharp  
24 cm



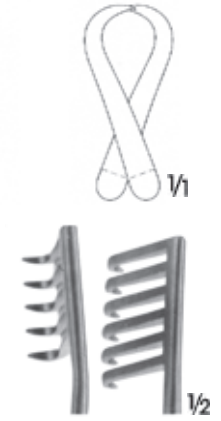
**56-568**  
Sivri/Sharp  
25.5 cm



**56-569**  
Yarı sivri  
Semi-sharp  
19.5 cm



**56-570**  
Yarı sivri  
Semi-sharp  
24 cm



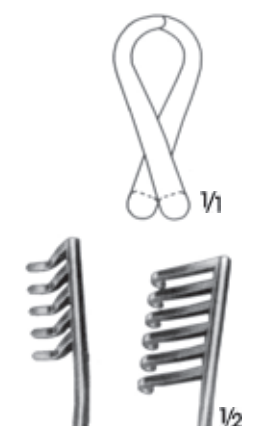
**56-571**  
Yarı sivri  
Semi-sharp  
25.5 cm



**56-572**  
Künt/Blunt  
19.5 cm



**56-573**  
Künt/Blunt  
24 cm



**56-574**  
Künt/Blunt  
25.5 cm



WEITLANER





MISKIMON  
56-575 Sivri/Sharp  
19 cm

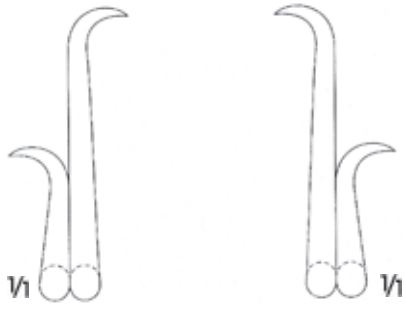


NORFOLK-NORWICH  
56-576 Künt/Blunt 22  
cm



ADSON  
56-577 Sivri/Sharp  
26.5 cm





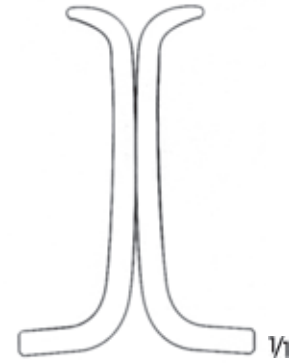
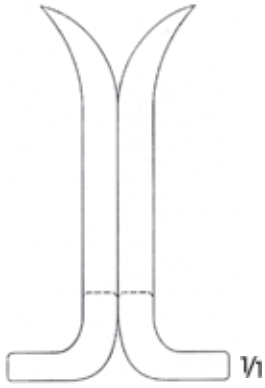
**56-579**  
Sivri/Sharp  
28 cm



**BECKMANN-ADSON**  
**56-581**  
Yarı sivri/Semi-sharp  
31 cm

**56-578**  
Hemi Laminektomi ekartör/Sivri  
Hemi-laminectomy retractor/Sharp  
28 cm

**BECKMANN-ADSON**  
**56-580**  
Sivri/Sharp  
31 cm



BECKMANN-EATON  
**56-581** Sivri/ Sharp  
32 cm



ADSON  
**56-582**  
Yarı Sivri/Semi Sharp  
32 cm



**1/2**  
HARLEY JACKSON  
**56-583**  
Sivri/Sharp  
28 cm



Üniversal Ekartör  
Universal Retractor

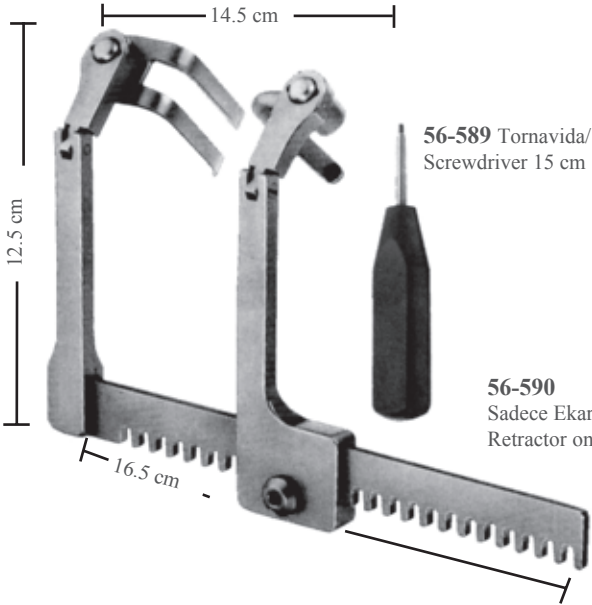


- 56-584** 50 x 44 mm
- 56-585** 50 x 54 mm
- 56-586** 50 x 74 mm
- 56-587** 50 x 89 mm



- 56-588**  
Ekartörleri yerleştirme kolu  
Retractor placing handle

Spinal Ekartör  
Spine Retractor



**56-589** Tornavida/  
Screwdriver 15 cm

**56-590**  
Sadece Ekartör  
Retractor only

Üniversal spinal ekartör sistemi  
Kendinden tutuculu Caspar üniversal omurga ekartörü,  
güvenli bir ekartasyona izin verir ve sökölüp takılabilir saplar  
sayesinde operasyon bölgesinde yer kazandırır.

Üniversal spinal retractor system  
The self-retaining Caspar universal spinal retractor permits safe  
retraction and saves in the operation area due to the remov-  
able handles.

CASPAR  
**56-591** Komple/Complete



- 56-592** 38 mm
- 56-593** 58 mm
- Pimli/Pins



- 56-594** 32 x 22 mm
- 56-595** 37 x 22 mm
- 56-596** 42 x 22 mm
- 56-597** 47 x 22 mm
- 56-598** 52 x 22 mm
- 56-599** 57 x 22 mm
- 56-600** 62 x 22 mm
- 56-601** 67 x 22 mm
- Pimli/Pins



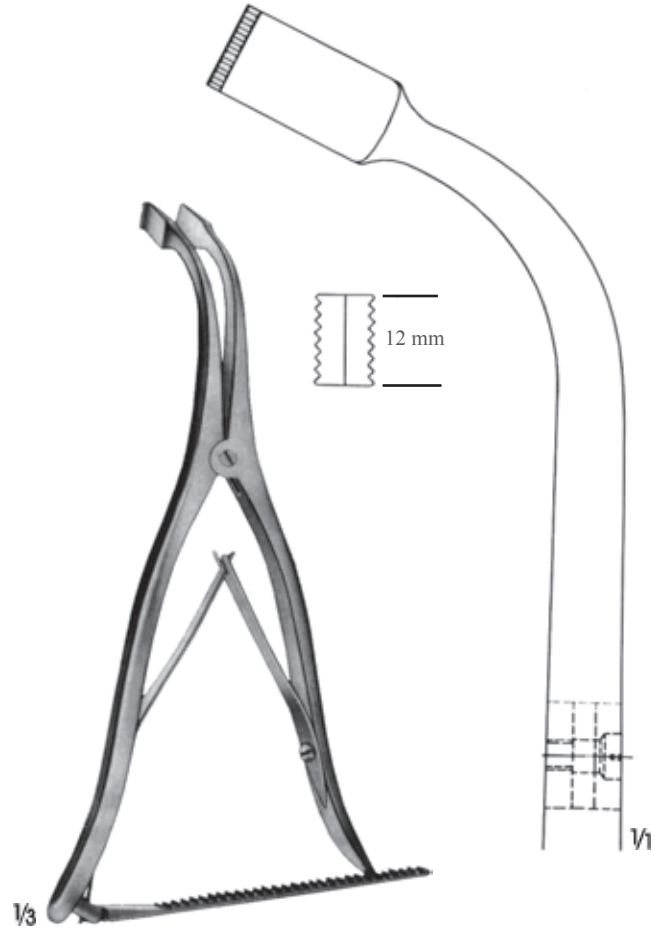
- 56-602** 32 x 37 mm
- 56-603** 37 x 37 mm
- 56-604** 42 x 37 mm
- 56-605** 47 x 37 mm
- 56-606** 52 x 37 mm
- 56-607** 57 x 37 mm
- 56-608** 62 x 37 mm
- 56-609** 67 x 37 mm
- Pimli/Pins



- 56-610** 32 x 52 mm
- 56-611** 37 x 52 mm
- 56-612** 42 x 52 mm
- 56-613** 47 x 52 mm
- 56-614** 52 x 52 mm
- 56-615** 57 x 52 mm
- 56-616** 62 x 52 mm
- 56-617** 67 x 52 mm
- Pimli/Pins



INGE  
56-618  
17 cm



INGE  
56-619  
27.5 cm



CLOWARD  
56-620  
15.5 cm



CLOWARD  
56-621  
13.5 cm



**57**



21.5 cm

Öne/Forward Düz/Straight		0000	0000	01	0	
		0	0	0	0	0
Öne/Forward Açılı/Angle		0000	0000	01	0	
		0	0	0	0	0
Öne/Forward Açılı/Angle		57-100	57-101	57-102	57-103	57-104
Geriye/Backward Düz/Straight		0000	0000	01	0	
		0	0	0	0	0
Geriye/Backward Düz/Straight		57-110	57-111	57-112	57-113	57-114
Geriye/Backward Açılı/Angle		0000	0000	01	0	
		0	0	0	0	0
Geriye/Backward Açılı/Angle		57-115	57-116	57-117	57-118	57-119



24 cm

Öne/Forward Düz/Straight		0000	0000	01	0	
		0	0	0	0	0
Öne/Forward Açılı/Angle		0000	0000	01	0	
		0	0	0	0	0
Öne/Forward Açılı/Angle		57-120	57-121	57-122	57-123	57-124
Geriye/Backward Düz/Straight		0000	0000	01	0	
		0	0	0	0	0
Geriye/Backward Düz/Straight		57-130	57-131	57-132	57-133	57-134
Geriye/Backward Açılı/Angle		0000	0000	01	0	
		0	0	0	0	0
Geriye/Backward Açılı/Angle		57-135	57-136	57-137	57-138	57-139







24 cm

		0	12	
Geriyeye/Backward Düz/Straight		<b>57-140</b>	<b>57-141</b>	<b>57-142</b>

		0	12	
Geriyeye/Backward Açılı/Angle		<b>57-143</b>	<b>57-144</b>	<b>57-145</b>

		0	12	
Geriyeye/Backward Aşağı/Down		<b>57-146</b>	<b>57-147</b>	<b>57-148</b>



24 cm

		0	12	
Öne/Forward Düz/Straight		<b>57-149</b>	<b>57-150</b>	<b>57-151</b>

		0	12	
Öne/Forward Açılı/Angle		<b>57-152</b>	<b>57-153</b>	<b>57-154</b>

		0	12	
Öne/Forward Aşağı/Down		<b>57-155</b>	<b>57-156</b>	<b>57-157</b>



SCHEDE  
17 cm

fig. 000	fig. 00	fig. 0	fig. 1
<b>57-158</b> 3 mm	<b>57-159</b> 3.5 mm	<b>57-160</b> 4 mm	<b>57-161</b> 5.5 mm
fig. 2	fig. 3	fig. 4	
<b>57-162</b> 7 mm	<b>57-163</b> 8 mm	<b>57-164</b> 10.5 mm	



SCHEDE  
17 cm

fig. 000	fig. 00	fig. 0	fig. 1
<b>57-165</b> 2.5 mm	<b>57-166</b> 3.4 mm	<b>57-167</b> 4.2 mm	<b>57-168</b> 5.2 mm
fig. 2	fig. 3	fig. 4	
<b>57-169</b> 6.3 mm	<b>57-170</b> 7.4 mm	<b>57-171</b> 8 mm	



BRUNS  
16.5 cm

fig. 000	fig. 00	fig. 0	fig. 1
<b>57-172</b> 3 mm	<b>57-173</b> 4 mm	<b>57-174</b> 5 mm	<b>57-175</b> 6 mm
fig. 2	fig. 3	fig. 4	
<b>57-176</b> 8 mm	<b>57-177</b> 10 mm	<b>57-178</b> 12 mm	



BRUNS  
16.5 cm

fig. 000	fig. 00	fig. 0	fig. 1
<b>57-179</b> 3 mm	<b>57-180</b> 4 mm	<b>57-181</b> 5 mm	<b>57-182</b> 6 mm
fig. 2	fig. 3	fig. 4	
<b>57-183</b> 8 mm	<b>57-184</b> 10 mm	<b>57-185</b> 12 mm	




fig. 0000  
  
**57-186**  
 2.8 mm

fig. 000  
  
**57-187**  
 3.6 mm



fig. 00  
  
**57-188**  
 4.4 mm

fig. 0  
  
**57-189**  
 5.2 mm

**DAUBENSPECK**  
 20 cm

$\frac{1}{2}$


fig. 0000  
  
**57-190**  
 1.8 mm



fig. 000  
  
**57-191**  
 2.0 mm

fig. 00  
  
**57-192**  
 2.4 mm

fig. 0  
  
**57-193**  
 2.6 mm

fig. 1  
  
**57-194**  
 2.8 mm

**LEMBERT**  
 20 cm

$\frac{1}{2}$


fig. 00  
  
**57-195**  
 4.4 mm



fig. 0  
  
**57-196**  
 5.2 mm

fig. 1  
  
**57-197**  
 6.8 mm

**HALLE**  
 21.5 cm

$\frac{1}{2}$


fig. 000  
  
**57-198**  
 3.6 mm


fig. 00  
  
**57-199**  
 4.4 mm



fig. 0  
  
**57-200**  
 5.2 mm

fig. 1  
  
**57-201**  
 6.8 mm

**BUSHE**  
 25 cm

$\frac{1}{2}$


fig. 000  
  
**57-202**  
 3.6 mm


fig. 00  
  
**57-203**  
 4.4 mm



fig. 0  
  
**57-204**  
 5.2 mm

fig. 1  
  
**57-205**  
 6.8 mm

**BUSHE**  
 25 cm

$\frac{1}{2}$

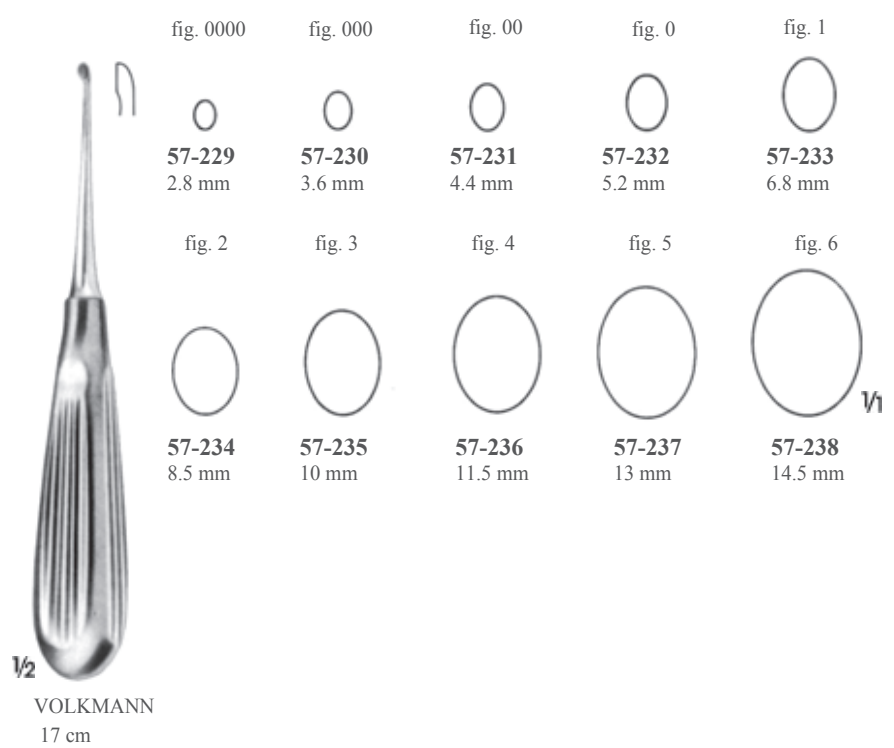
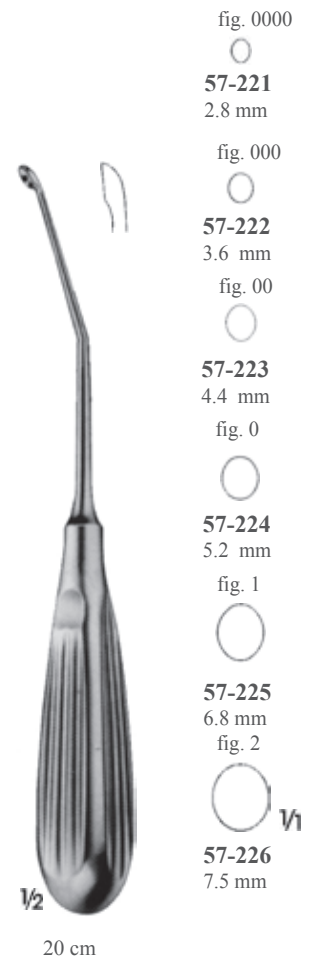
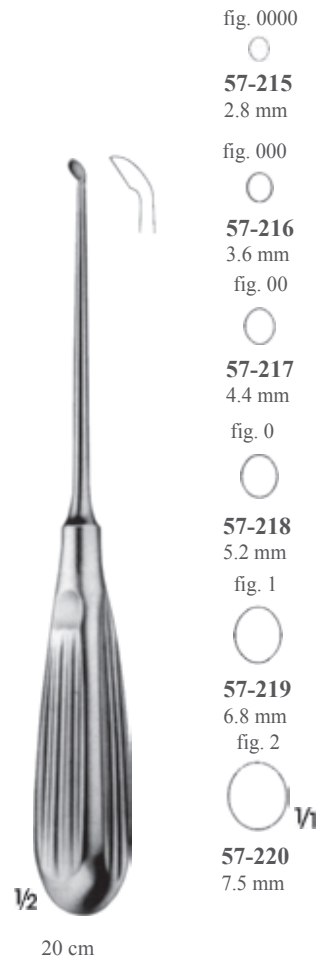
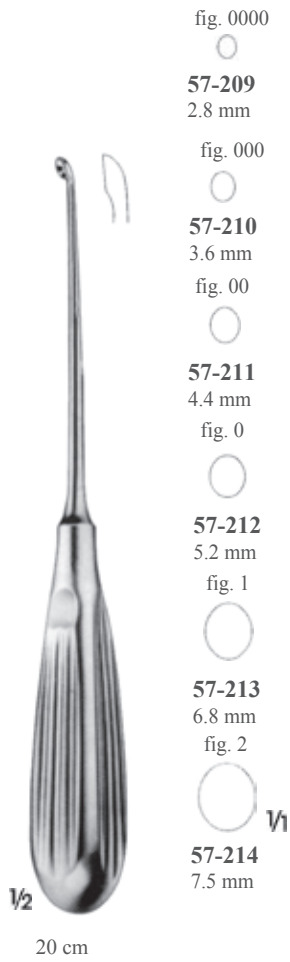
fig. 000  
  
**57-206**  
 3 mm

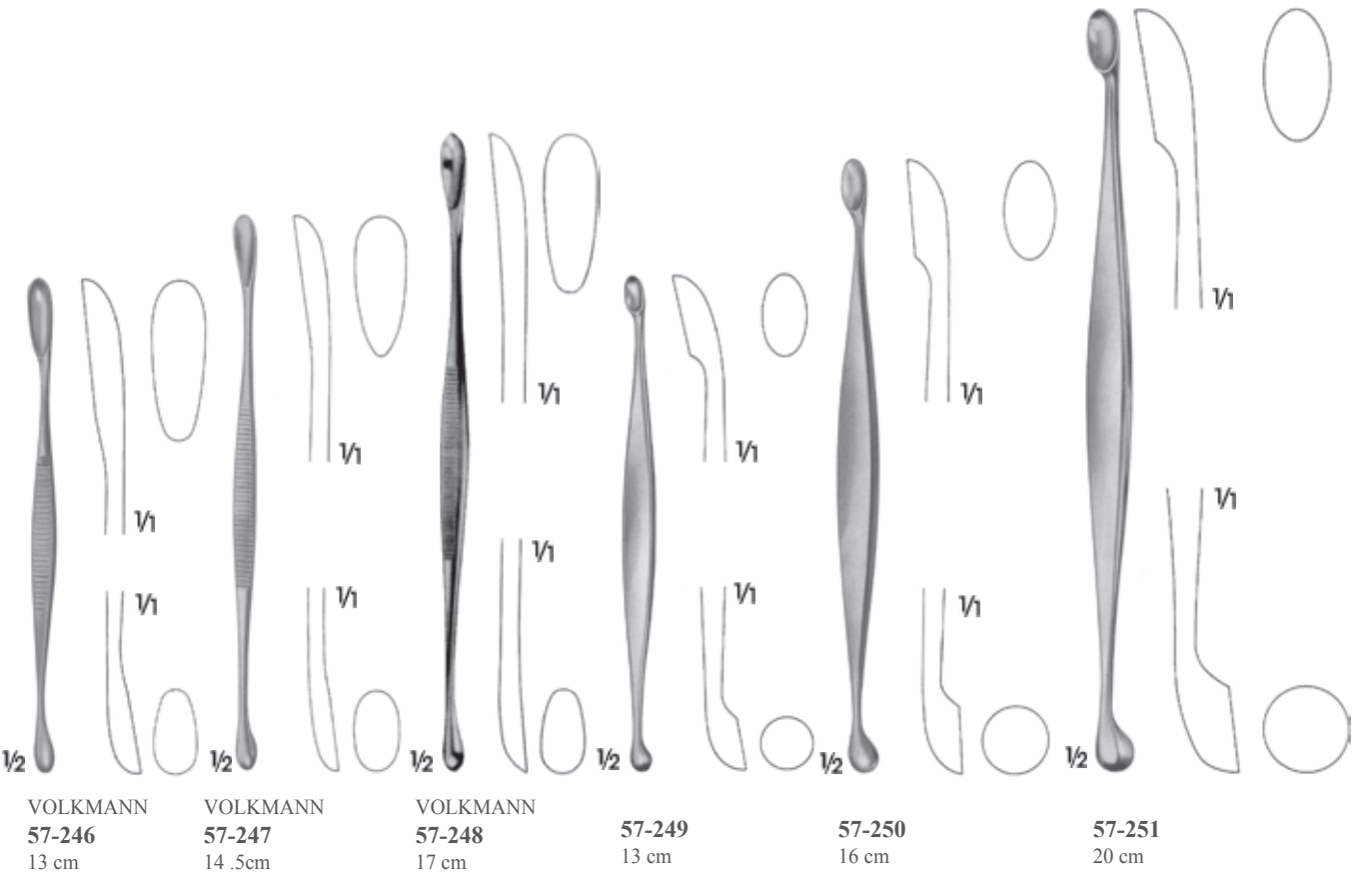
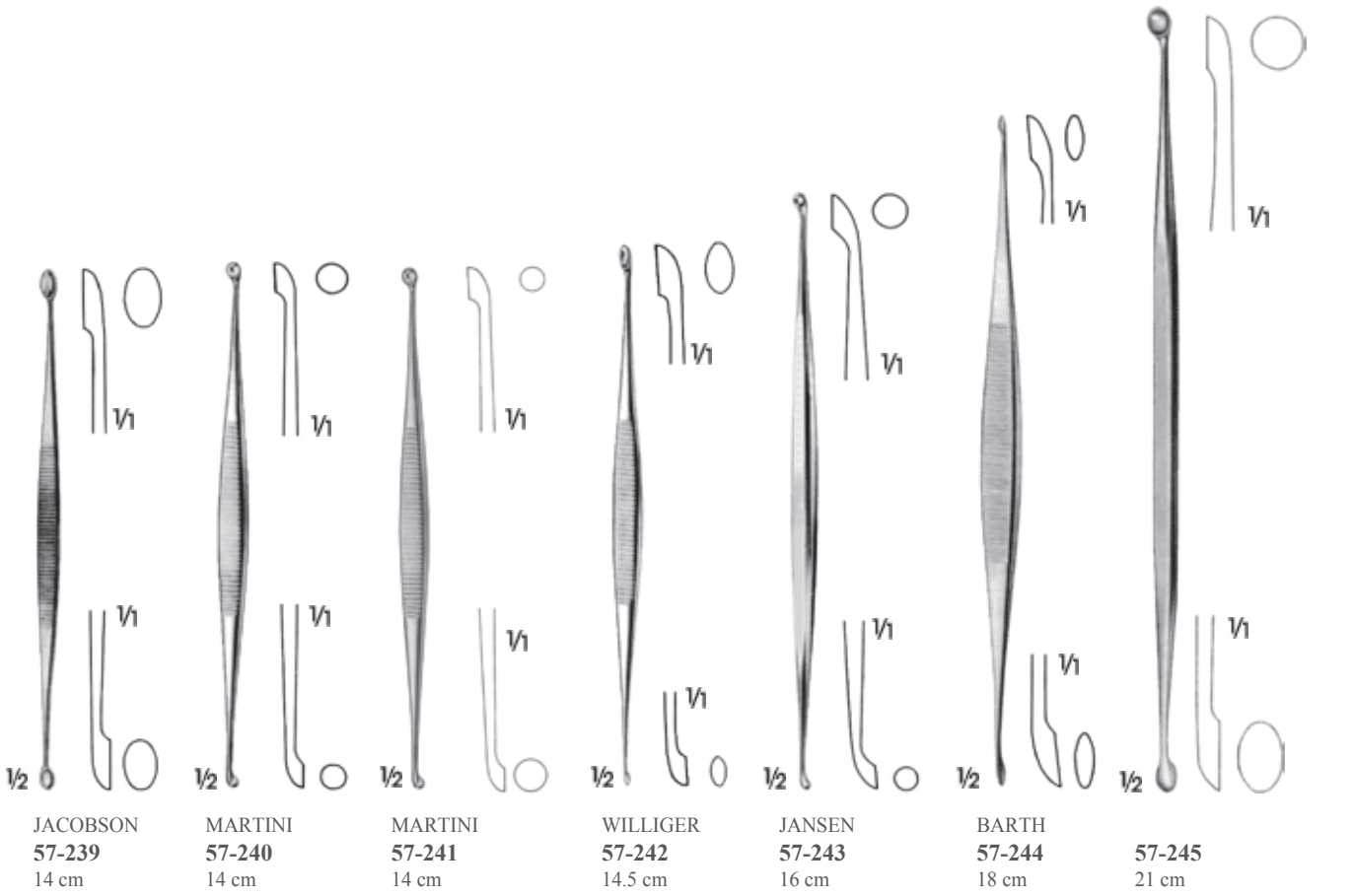
fig. 00  
  
**57-207**  
 4 mm

fig. 1  
  
**57-208**  
 5 mm

**BUSHE**  
 25 cm

$\frac{1}{2}$







HEMINGWAY  
57-252  
fig. 0  
17 cm



HEMINGWAY  
57-253  
fig. 1  
17 cm



HEMINGWAY  
57-254  
fig. 2  
17 cm



HEMINGWAY  
57-255  
fig. 3  
17 cm



HEMINGWAY  
57-256  
fig. 4  
17 cm



57-257  
16 cm



JANSEN  
57-258  
16 cm



HEMINGWAY  
57-259  
17 cm



HEMINGWAY  
57-260  
17 cm












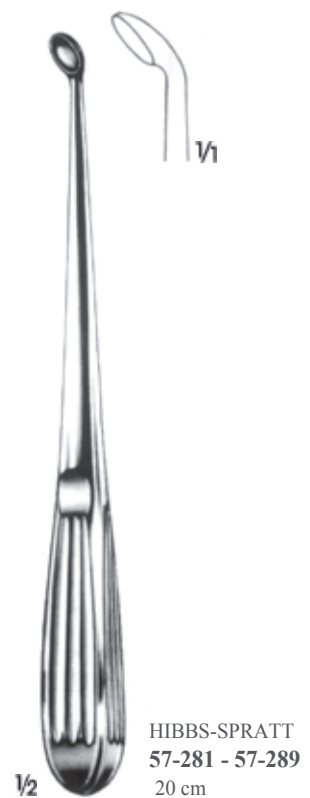
LUCAS  
57-261  
18 cm

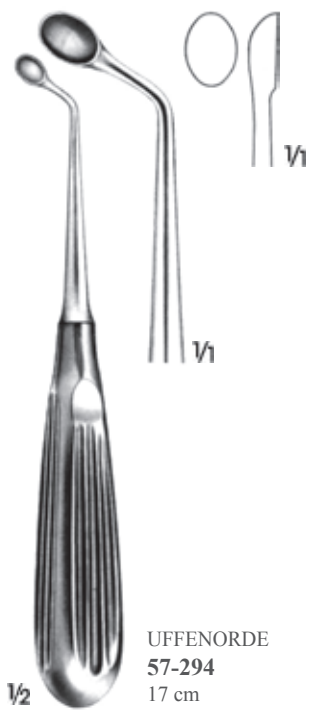


LUCAS  
57-262  
18.5 cm

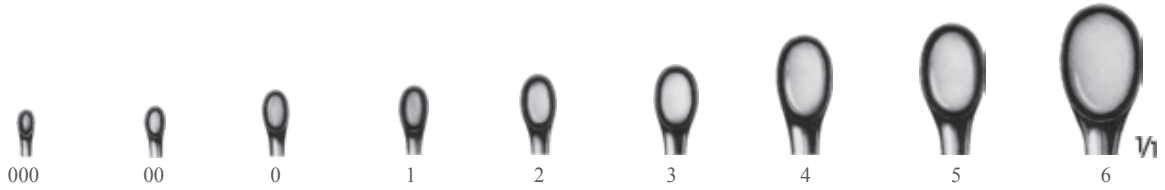


								
Fig.000	Fig.00	Fig.0F	ig.1	Fig.2F	ig.3	Fig.4F	ig.5	Fig.6
57-263 1.8 mm	57-264 2.2 mm	57-265 3.5 mm	57-266 4.0 mm	57-267 4.5 mm	57-268 5.5 mm	57-269 7.2 mm	57-270 8.5 mm	57-271 10.5 mm
57-272 1.8 mm	57-273 2.2 mm	57-274 3.5 mm	57-275 4.0 mm	57-276 4.5 mm	57-277 5.5 mm	57-278 7.2 mm	57-279 8.5 mm	57-280 10.5 mm
57-281 1.8 mm	57-282 2.2 mm	57-283 3.5 mm	57-284 4.0 mm	57-285 4.5 mm	57-286 5.5 mm	57-287 7.2 mm	57-288 8.5 mm	57-289 10.5 mm









<b>57-299</b> 1.8 mm	<b>57-300</b> 2.2 mm	<b>57-301</b> 3.5 mm	<b>57-302</b> 4.0 mm	<b>57-303</b> 4.5 mm	<b>57-304</b> 5.5 mm	<b>57-305</b> 7.2 mm	<b>57-306</b> 8.5 mm	<b>57-307</b> 10.5 mm
<b>57-308</b> 1.8 mm	<b>57-309</b> 2.2 mm	<b>57-310</b> 3.5 mm	<b>57-311</b> 4.0 mm	<b>57-312</b> 4.5 mm	<b>57-313</b> 5.5 mm	<b>57-314</b> 7.2 mm	<b>57-315</b> 8.5 mm	<b>57-316</b> 10.5 mm
<b>57-317</b> 1.8 mm	<b>57-318</b> 2.2 mm	<b>57-319</b> 3.5 mm	<b>57-320</b> 4.0 mm	<b>57-321</b> 4.5 mm	<b>57-322</b> 5.5 mm	<b>57-323</b> 7.2 mm	<b>57-324</b> 8.5 mm	<b>57-325</b> 10.5 mm
<b>57-326</b> 1.8 mm	<b>57-327</b> 2.2 mm	<b>57-328</b> 3.5 mm	<b>57-329</b> 4.0 mm	<b>57-330</b> 4.5 mm	<b>57-331</b> 5.5 mm	<b>57-332</b> 7.2 mm	<b>57-333</b> 8.5 mm	<b>57-334</b> 10.5 mm



BRUNS  
57-299 - 57-307  
23 cm



BRUNS  
57-308 - 57-316  
23 cm



BRUNS  
57-317 - 57-325  
23 cm



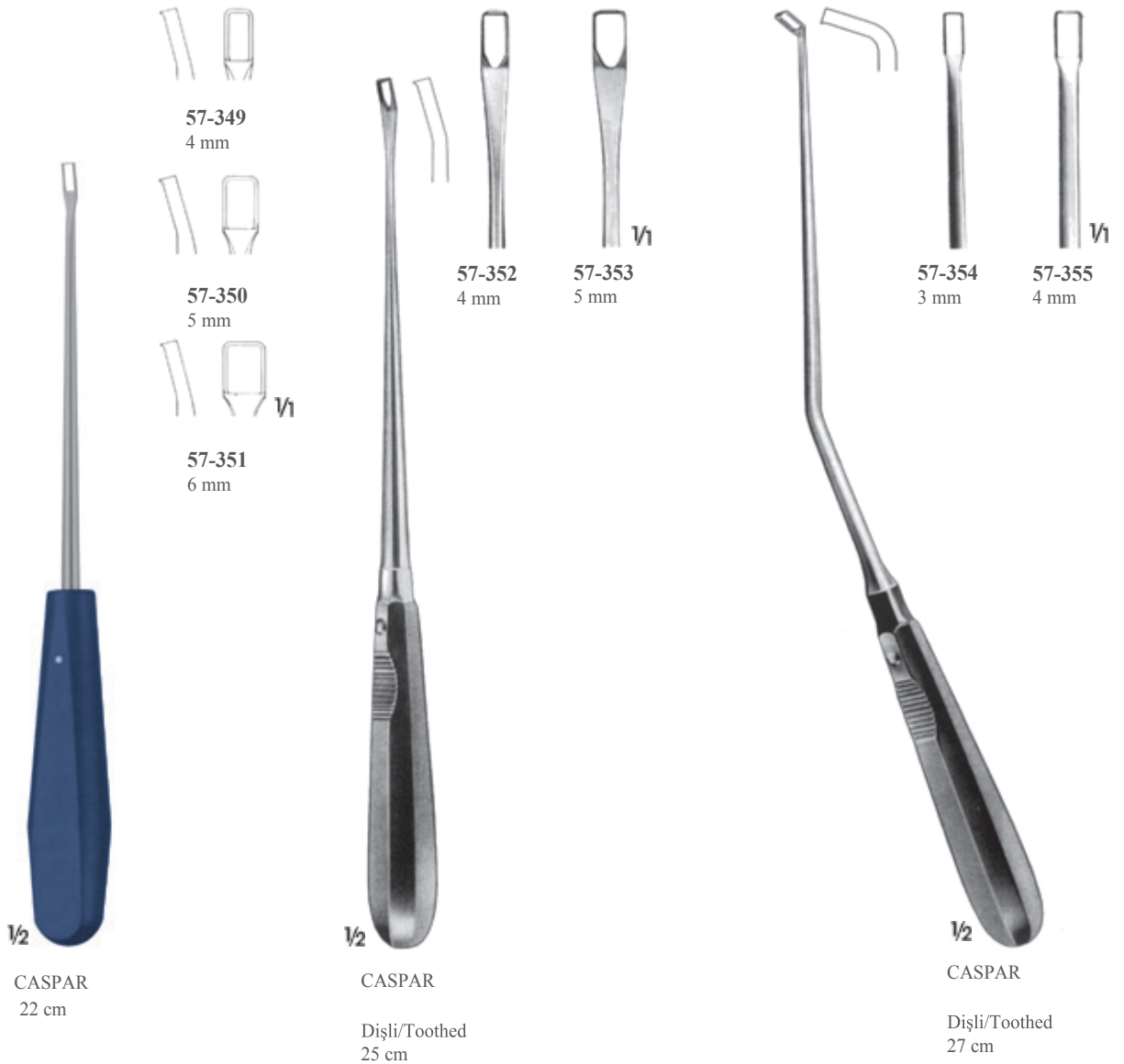
BRUNS  
57-326 - 57-334  
23 cm



143° buhar sterilizatörlerinde steril edilebilir.  
Can be sterilized in a steam sterilizer up to 143 °



143 ° buhar sterilizatörlerinde steril edilebilir.  
Can be sterilized in a steam sterilizer up to 143 °





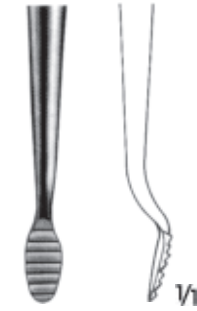
MILLER  
18 cm

1/2



57-356

8 mm



5 mm



57-357

6 mm



4.3 mm



57-358

6 mm



5 mm



GALLAHER  
57-359  
19 cm

1/2

6.5 mm

1/1



FOMON  
57-360  
21.5 cm

1/2



FOMON  
57-361  
21.5 cm

1/2

6.5 mm

1/1

7.5 mm



57-362  
22 cm

20 mm

6.5 mm

1/1

7.5 mm

Bir tarafı eğe,  
bir tarafı raspa  
One side file cut  
one side rasp cut

1/2



57-363  
24 cm

1/2

13 mm

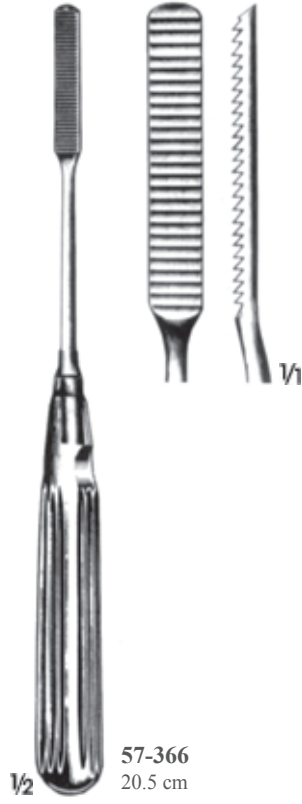
1/1



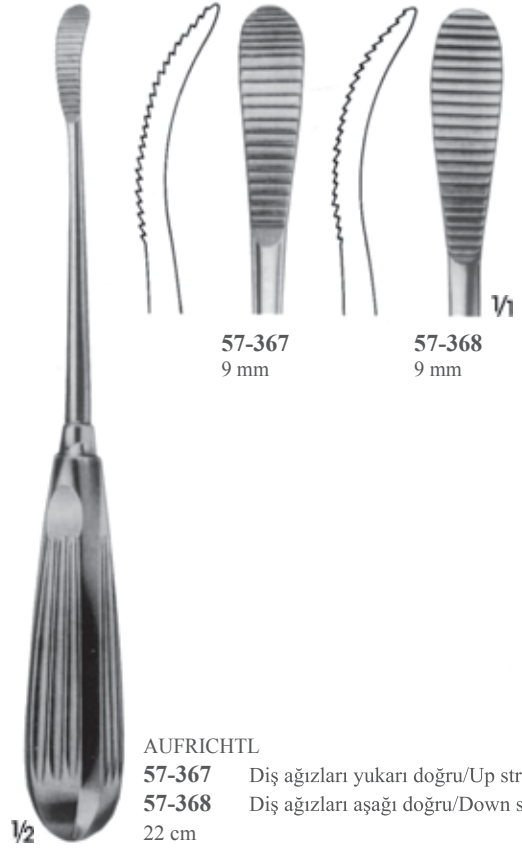
57-364

57-365

RUBIN  
20 cm



57-366  
20.5 cm



57-367  
9 mm

57-368  
9 mm

AUFRICHTL

57-367

57-368

22 cm

Diş ağızları yukarı doğru/Up stroke

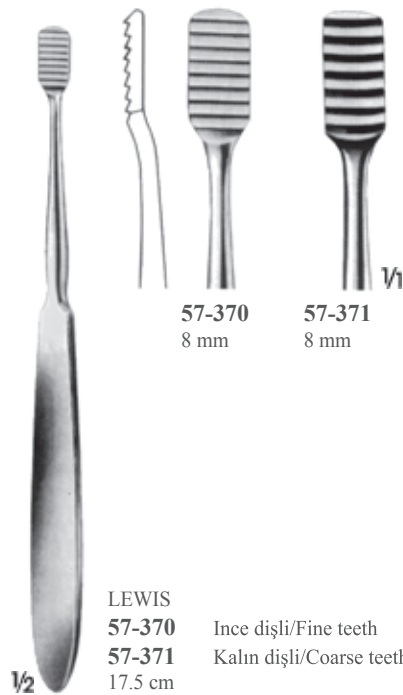
Diş ağızları aşağı doğru/Down stroke



9 mm

MALTZ  
57-369

Diş ağızları aşağı doğru  
Down stroke  
18 cm



57-370  
8 mm

57-371  
8 mm

LEWIS

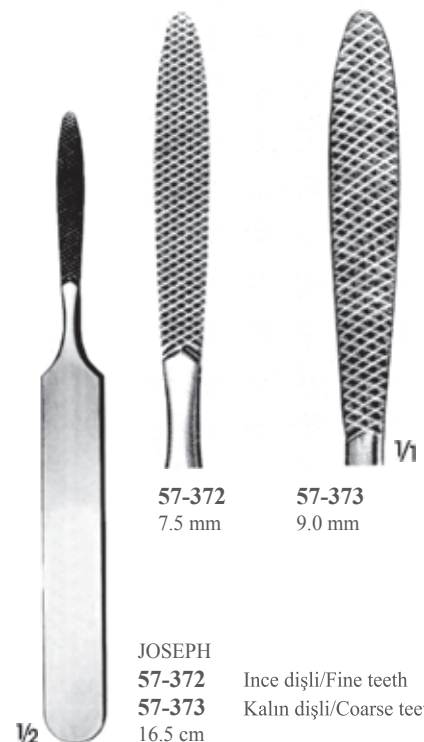
57-370

57-371

17.5 cm

Ince dişli/Fine teeth

Kalın dişli/Coarse teeth



57-372  
7.5 mm

57-373  
9.0 mm

JOSEPH

57-372

57-373

16.5 cm

Ince dişli/Fine teeth

Kalın dişli/Coarse teeth



143 ° buhar sterilizörlerinde steril edilebilir.  
Can be sterilized in a steam sterilizer up to 143 °







1/2

20.5 cm

Diş  
Teeth

7 mm



1

7 mm



3

7 mm



5

7 mm



7

7 mm



9



2

57-399  
12/14



4

57-400  
16/20



6

57-401  
24/30



8

57-402  
36/44



10

57-403  
52/62

V1





PUTTI  
57-404  
30 cm

20 mm



1/2  
57-405  
29.5 cm

18 mm

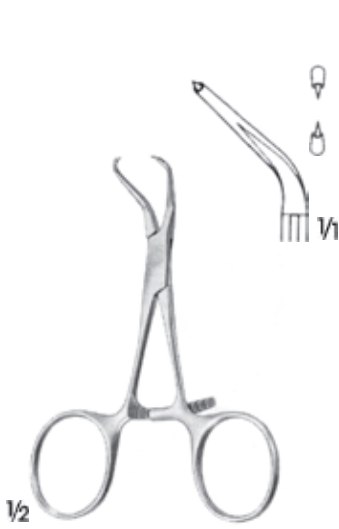


1/2  
20 mm  
PUTTI  
57-406  
27 cm





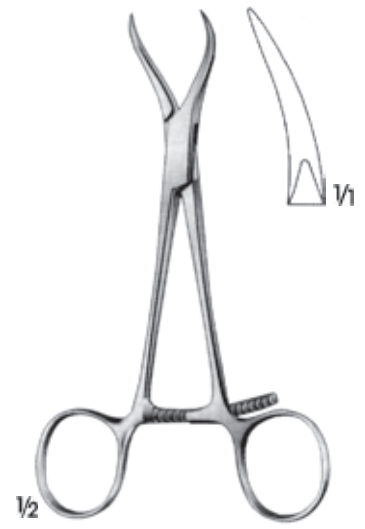
58



**58-100**  
Setli, pozisyon pensi  
Reposition forceps with  
stepped tips  
9.5 cm



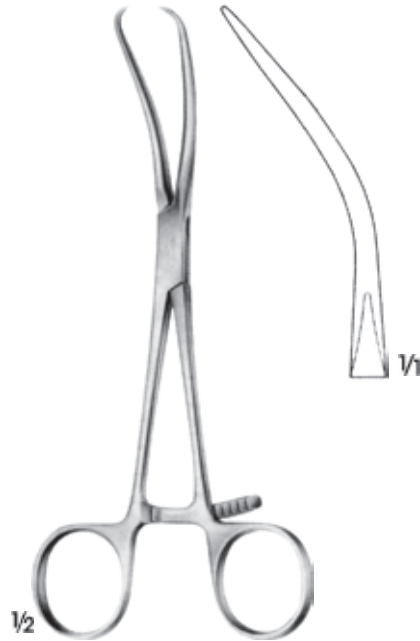
**58-101**  
Küçük parçaları  
konumlandırma pensi  
Reposition forceps for small  
fragments  
13.5 cm



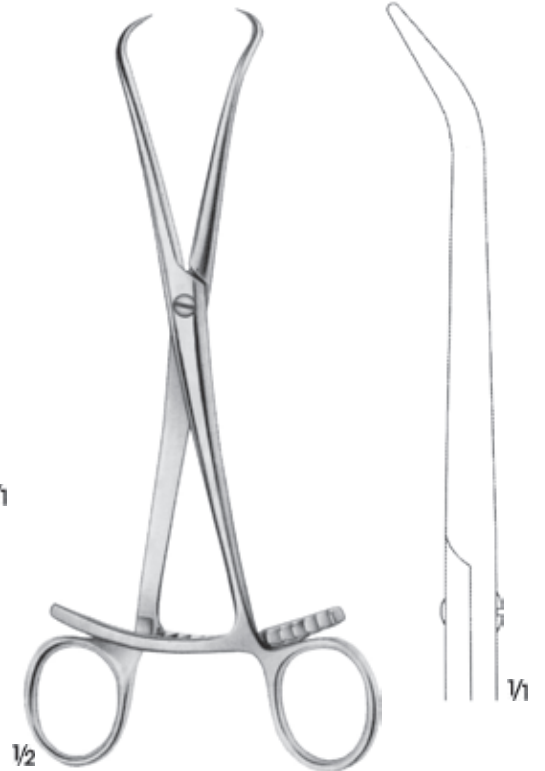
**58-102**  
Çene kemiğine ait  
konumlandırma pensi  
Reposition forceps, especially  
for maxillary reposition  
13.5 cm



**HAASE**  
**58-103**  
Pozisyon pensi, çeneye ait  
kırıklar için  
Reposition forceps for  
mandibular fractures  
16.5 cm



**REILL**  
**58-104**  
Pozisyon pensi  
Reposition forceps  
17 cm



**58-105**  
Pozisyon pensi  
Reposition forceps  
20.5 cm



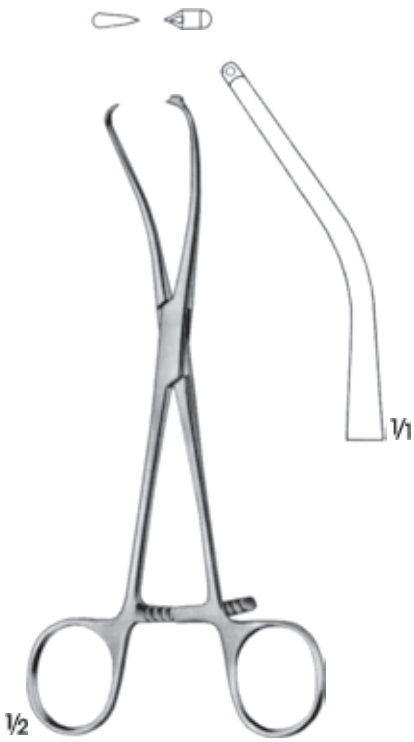
**FÖRSTNER**  
**58-106**  
14 cm



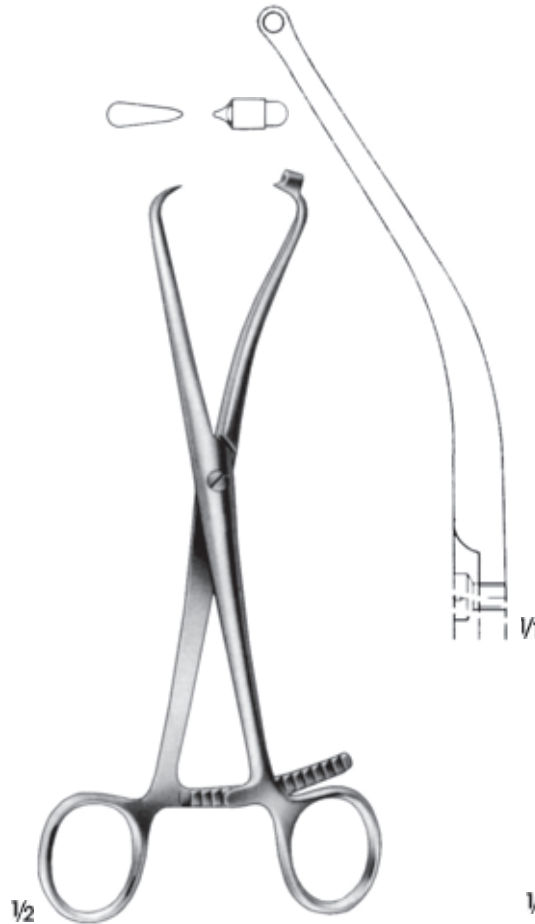
**58-107**  
13.5 cm



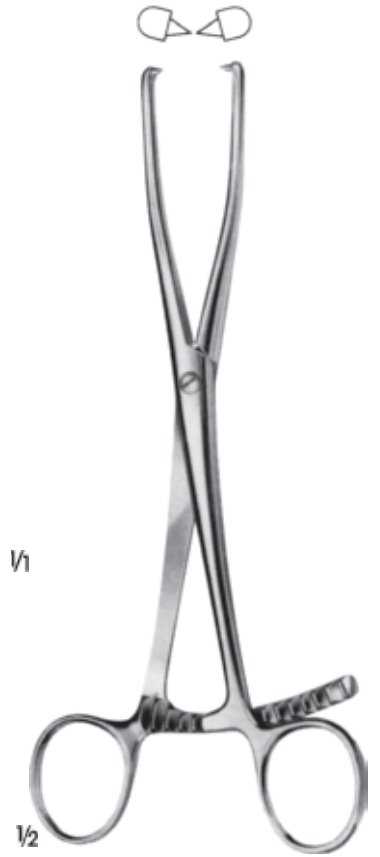
**HAASE**  
**58-108**  
14 cm



**MEYER**  
**58-109**  
Kişner telleri için matkap kılavuzu,  
yeniden konumlandırıcı  
Reposition forceps for fingers,  
with drill guide for KIRSCHNER  
kullanılan tel Ø 1.0 mm  
For wires with Ø 1.0 mm  
17 cm

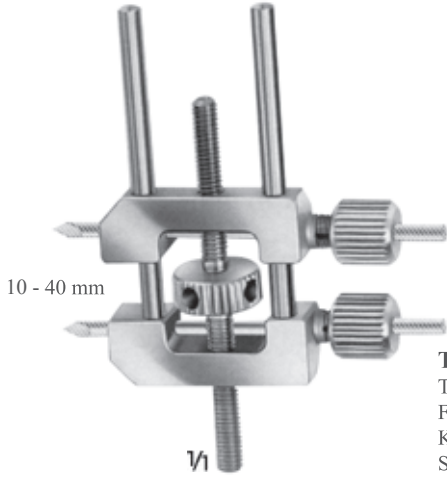


**MEYER**  
**58-110**  
Kişner telleri için matkap kılavuzu,  
yeniden konumlandırıcı  
Reposition forceps for fingers,  
with drill guide for KIRSCHNER  
kullanılan tel Ø 2.0 mm  
For wires with Ø 2.0 mm  
20.5 cm



**58-111**  
Malleolus pens  
Malleolar forceps  
21 cm



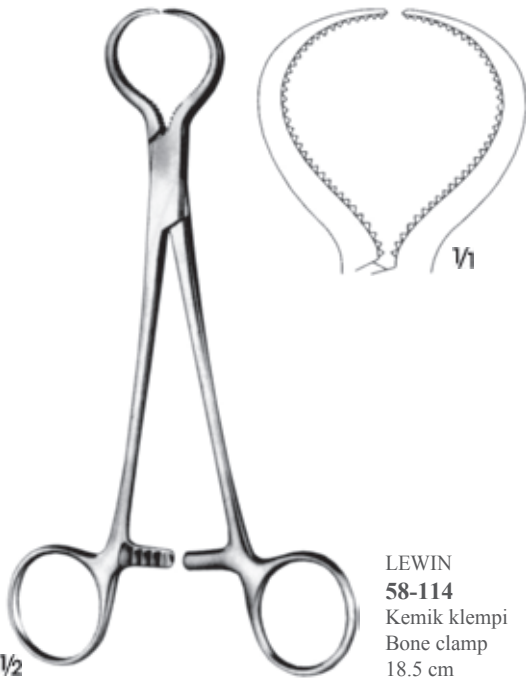


**T3-112**  
Tel Ø 3.0 mm  
For wires Ø 3.0 mm  
Küçük kemikleri yaklaştırma aparatı  
Small bones of the zoom apparatus



Vidalanabilir kemik parçasını  
KIRSCHNER teli kullanarak sabitleme  
Position, Re-giver bony part of the wire  
can be screwed KIRSCHNER  
stabilization using

**WÖRRLEIN**  
**58-113**  
Pozisyon verici  
Positöner/Repositöner  
16.5 cm



**LEWIN**  
**58-114**  
Kemik klempsi  
Bone clamp  
18.5 cm



**58-115**  
Diz kapağı pensi  
Patella forceps  
18.5 cm



**58-116**  
Sekestrum pensi  
Sequestrum forceps  
20 cm



1/2  
**58-117**  
 Kilitlenebilir, sabitlenebilir pens  
 Forceps with ratchet fixation  
 14 cm



1/2  
**58-118**  
 Vida ile sabitlenebilir pens  
 Forceps with thread fixation  
 17 cm



1/2  
**58-119**  
 Vida ile sabitlenebilir pens  
 Forceps with thread fixation  
 23.5 cm



5 mm

1/2  
**58-120**  
 Kemik tutma pensi  
 Bone holding forceps  
 20 cm



11 mm

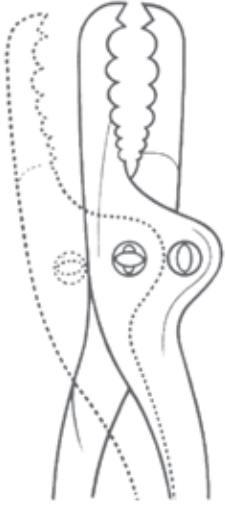
1/2  
**LANGENBECK**  
**58-121**  
 Kemik tutma pensi  
 Bone holding forceps  
 20.5 cm



12 mm

1/2  
**FERGUSON**  
**58-122**  
 Kemik tutma pensi  
 Bone holding forceps  
 20.5 cm





Ayarlanabilir ağız  
Jaw adjustable



FARABEUF  
58-123  
23cm



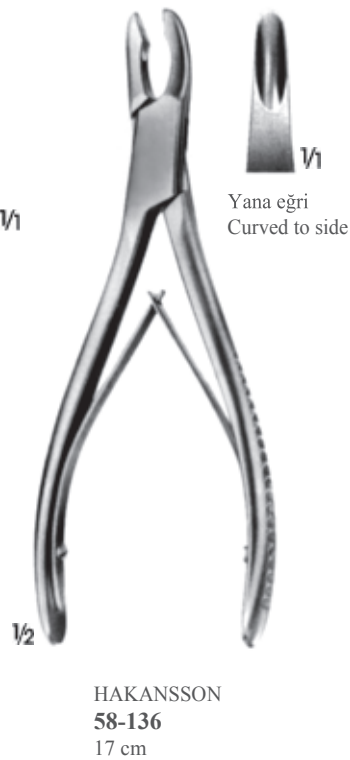
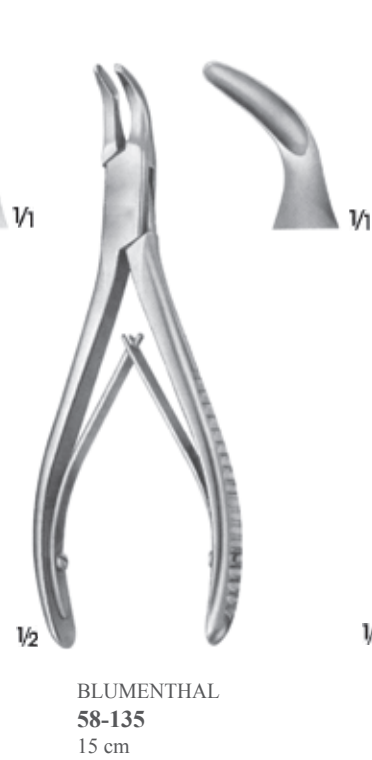
FARABEUF  
58-124  
25.5 cm



FARABEUF-LAMBOTTE  
58-125  
25.5 cm









$\frac{1}{2}$   
**BÖHLER**  
**58-138**  
14.5 cm



$\frac{1}{2}$   
**BÖHLER**  
**58-139**  
14.5 cm



$\frac{1}{2}$   
**58-140**  
17 cm



$\frac{1}{2}$   
**MC INDOE**  
**58-141**  
17.5 cm



$\frac{1}{2}$   
**RUSKIN-LISTON**  
**58-142**  
19 cm



$\frac{1}{2}$   
**RUSKIN-LISTON**  
**58-143**  
19 cm



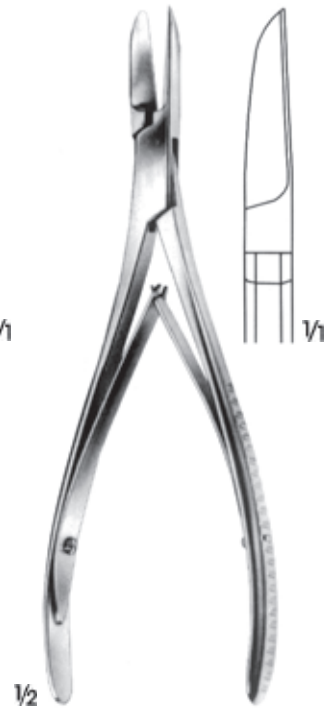
**58-144**  
13 cm



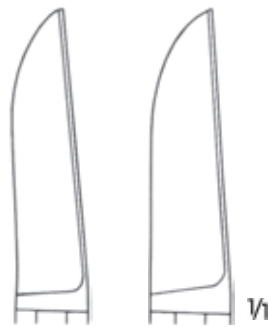
**STAMM**  
**58-145**  
15 cm



**58-146**  
17 cm

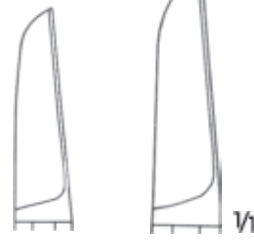


**KAZANJIAN**  
**58-147**  
18.5 cm



**58-148**  
20 cm

**58-149**  
22 cm



**58-150**  
14 cm

**58-151**  
17 cm



**58-152**  
17 cm



**58-153**  
20 cm



**58-154**  
22 cm



**LISTON**

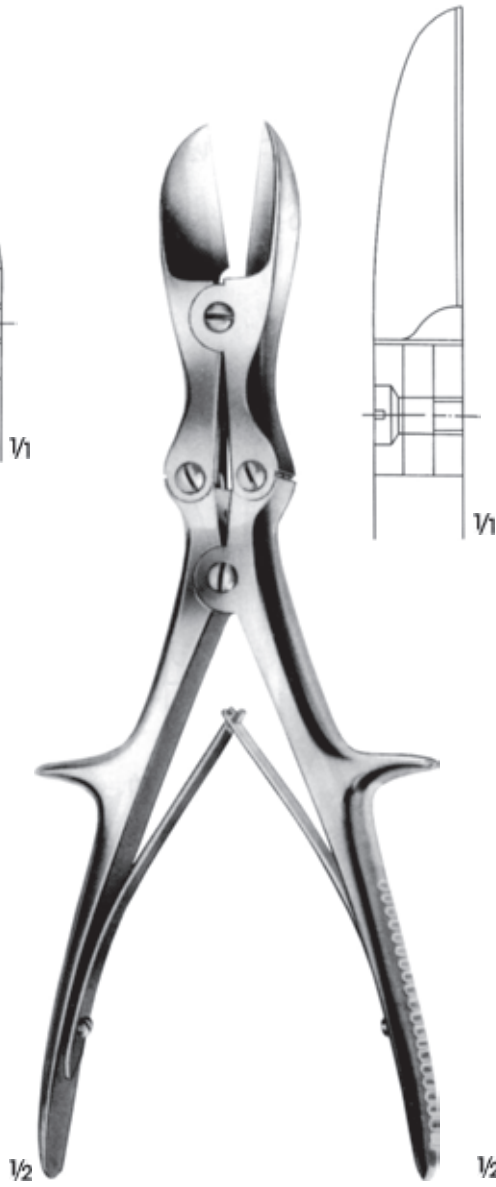


**LISTON**

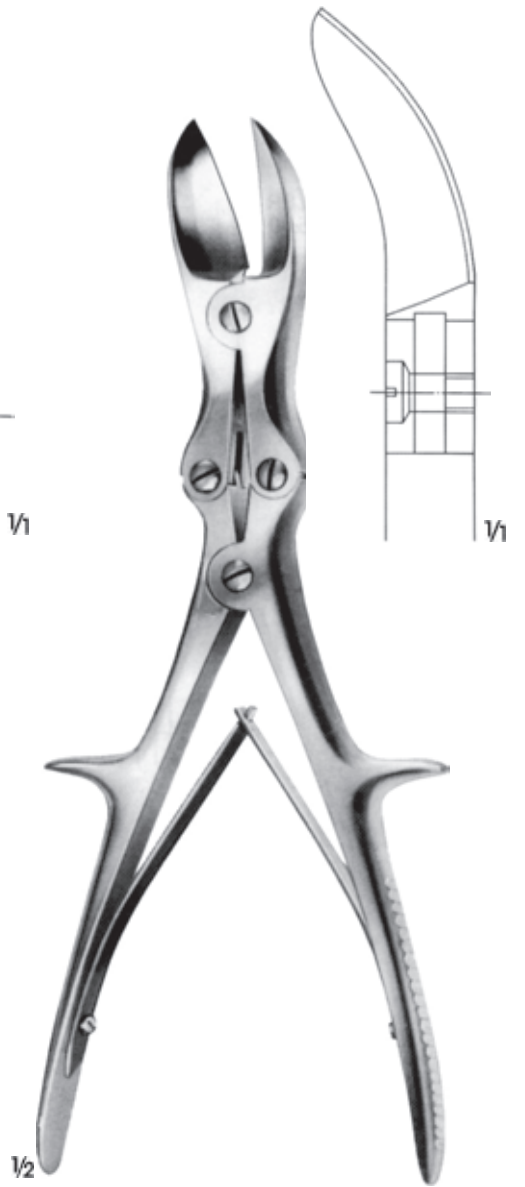




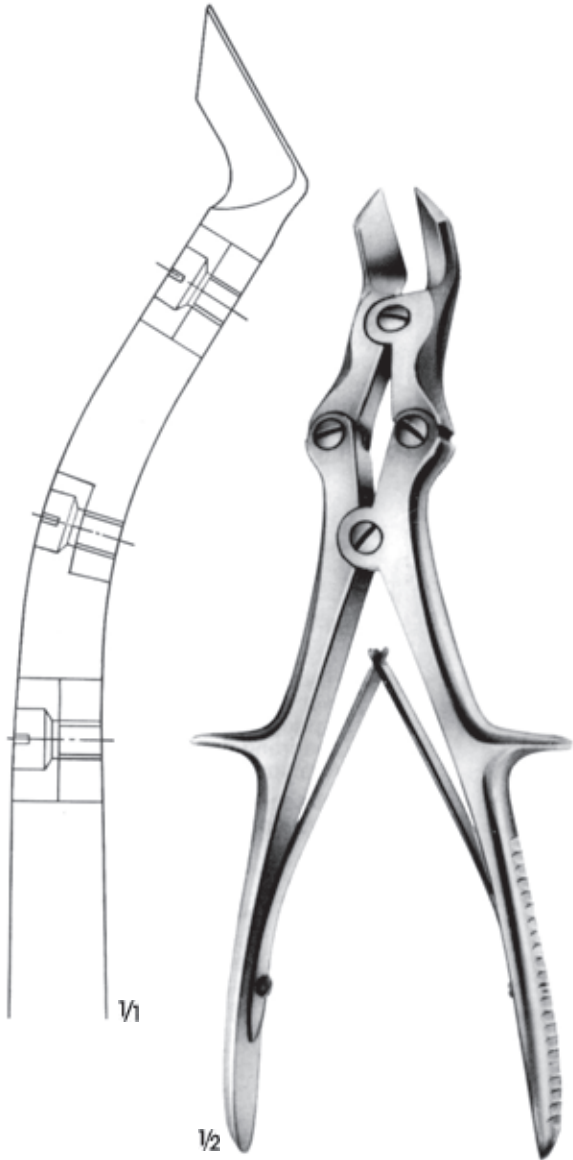
LISTON  
**58-155**  
Düz eğimli/Curved on flat  
24 cm



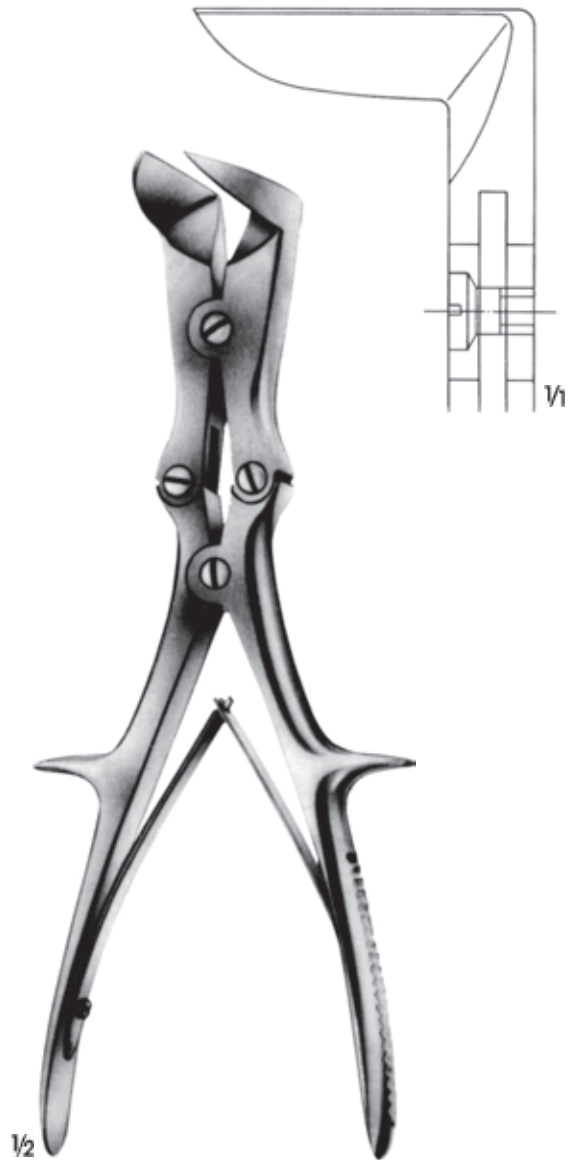
LISTON  
**58-156**  
Düz/Straight  
28 cm



LISTON  
**58-157**  
Düz eğimli/Curved on flat  
28 cm



LISTON-KEY-HORSLEY  
58-158  
25.5 cm

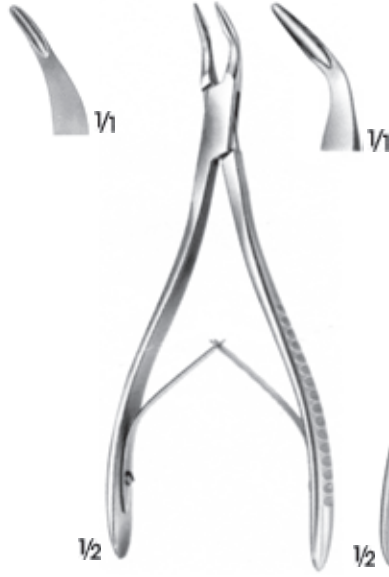


LISTON-STILLE  
58-158  
26.5 cm

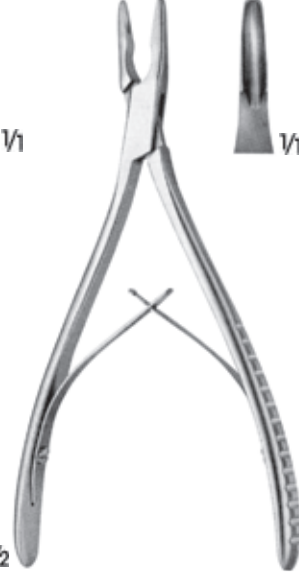




FRIEDMANN  
**58-159**  
Kemik Ronjur/Bone Rongeur  
14 cm



**58-160**  
Kemik Ronjur/Bone Rongeur  
15 cm



LEMBERT  
**58-161**  
Kemik Ronjur/Bone Rongeur  
16.5 cm



SCHWARZ  
**58-162**  
Kemik Ronjur/Bone Rongeur  
14.5 cm



STELLBRINK  
**58-163** Sinovektomi  
ronjur  
Synovectomy rongeur  
17.5 cm



STELLBRINK  
**58-164** Sinovektomi  
ronjur  
Synovectomy rongeur  
17 cm







JANSEN  
58-165  
17.5 cm



JANSEN  
58-166  
17.5 cm



LEMPERT  
20 cm



JANSEN  
58-169  
19 cm







**BANE-HARTMANN**  
**58-170**  
17.5 cm



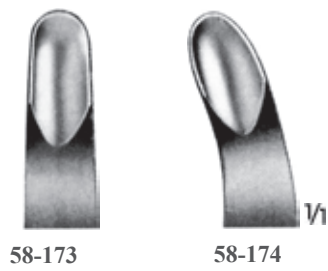
**LUER**  
**58-171**  
18 cm



**LUER**  
**58-172**  
18 cm

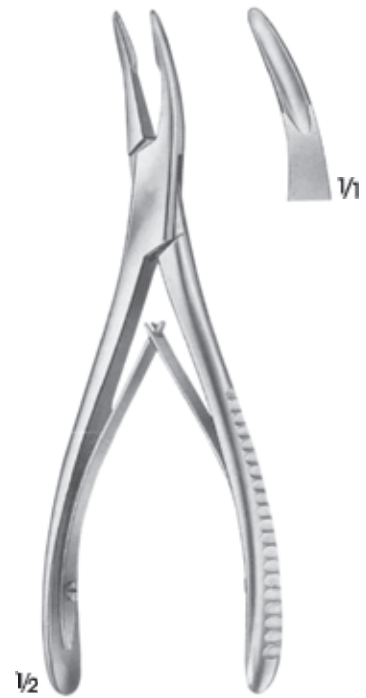


**LUER**  
17.5 cm

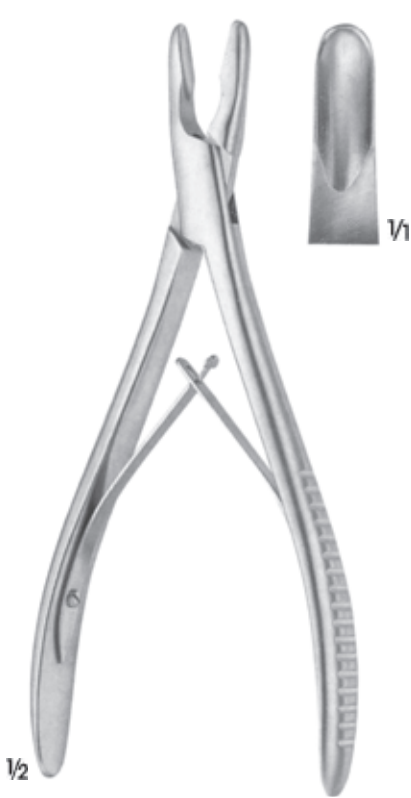


58-173

58-174



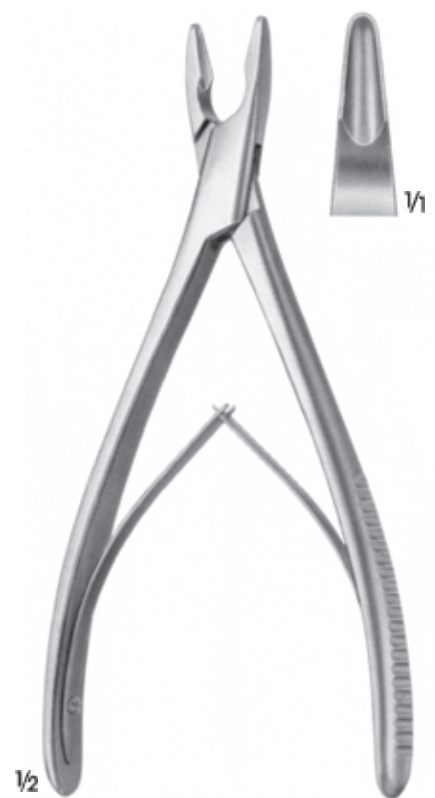
**BEYER**  
**58-175**  
18 cm



**ADSON**  
**58-176**  
20 cm



**NORTHFIELD**  
**58-177**  
21 cm



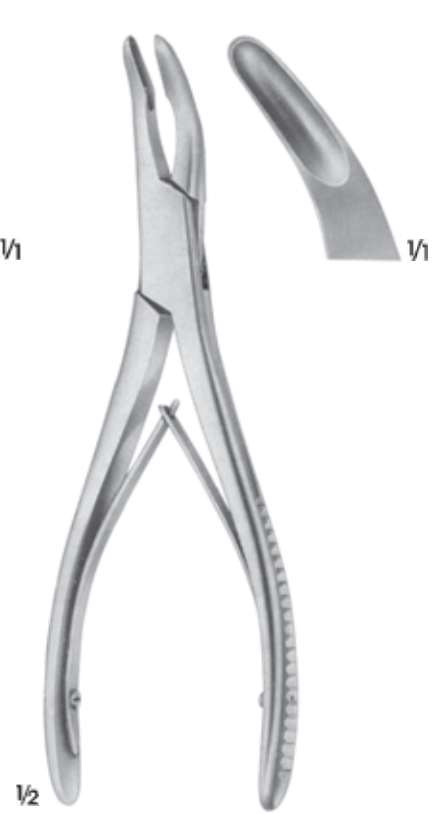
**PENNYBACKER**  
**58-178**  
20.5 cm



**TROTTER**  
**58-179**  
20.5 cm



**GULEKE**  
**58-180**  
20.5 cm



**OLIVECRONA**  
**58-181**  
20.5 cm







LEKSELL-STILLE  
58-190  
24 cm



STILLE-RUSKIN  
58-191  
24 cm



LUER-STILLE  
58-192  
22.5 cm



LUER-STILLE  
58-193  
22.5 cm







SAUERBRUCH-CORYLLOS  
31 cm



SYPERT  
58-202  
36 cm







SEMBO  
58-203  
24 cm



LUER-STILLE  
58-204  
27 cm



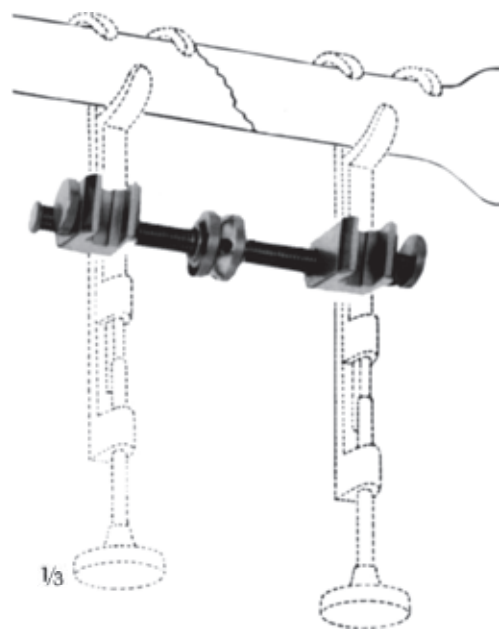
LOWMAN  
58-205 17 cm  
58-206 20.5 cm



1/2  
LOWMAN-GERSTER  
58-207  
21 cm

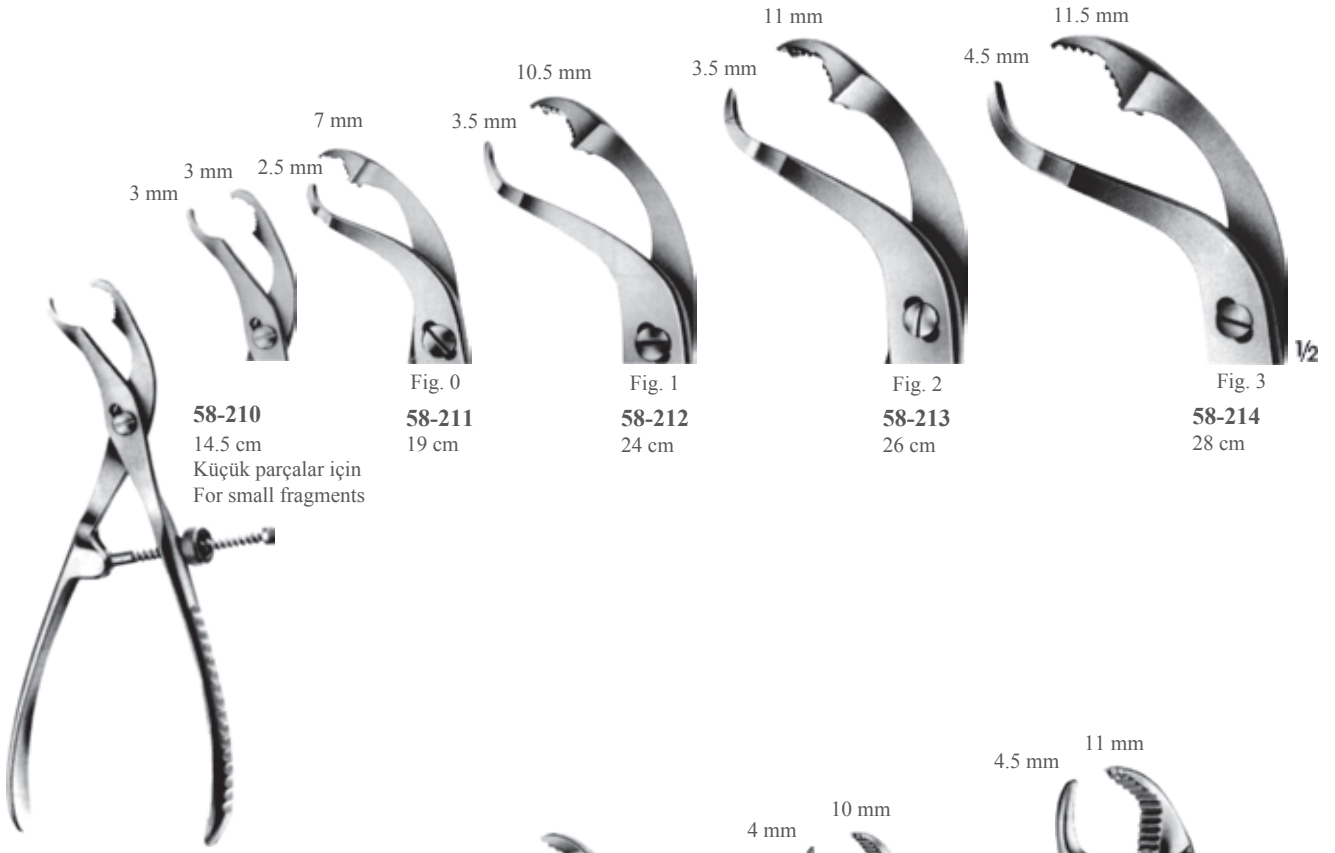


1/2  
LOWMAN-HOGLUND  
58-208  
17.5 cm



1/3  
GERSTER  
58-209





**58-210**  
14.5 cm  
Küçük parçalar için  
For small fragments

**Fig. 0**  
**58-211**  
19 cm

**Fig. 1**  
**58-212**  
24 cm

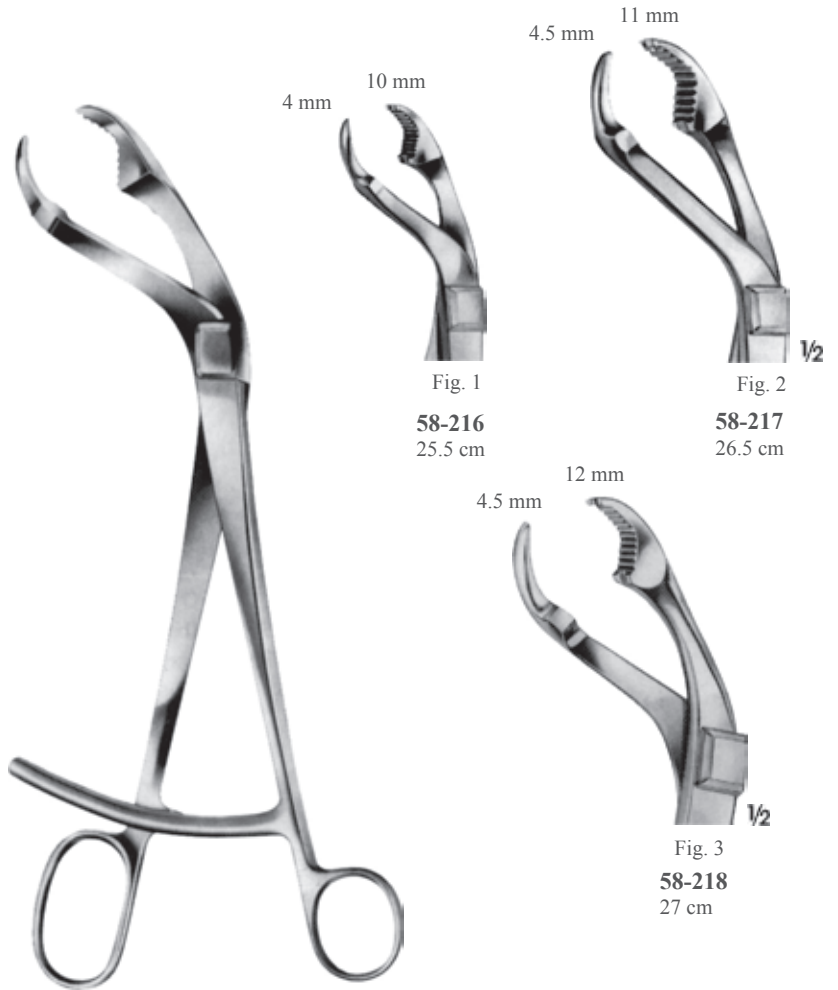
**Fig. 2**  
**58-213**  
26 cm

**Fig. 3**  
**58-214**  
28 cm

Kendi kendini  
merkezleyici,  
vidalı sabit pensler  
Self-centering forceps with  
thread fixation



**VERBRUGGE**  
**58-215**  
17.5 cm



**Fig. 1**  
**58-216**  
25.5 cm

**Fig. 2**  
**58-217**  
26.5 cm

**Fig. 3**  
**58-218**  
27 cm

**VERBRUGGE**  
Eklemlı ağız / With lip joint





7.5 mm



KERN-MINI  
58-219  
15.5 cm

9 mm



KERN-LANE  
58-220  
24 cm

13 mm



LANE  
58-221  
32 cm





HEY GROVES  
58-224  
21 cm



HEY GROVES  
58-225  
27 cm



HEY GROVES  
58-226  
30.5 cm

Haraketli çene  
Movable jaw



LAMBOTTE



58-227  
22 cm



58-228  
26 cm



58-229  
33 cm

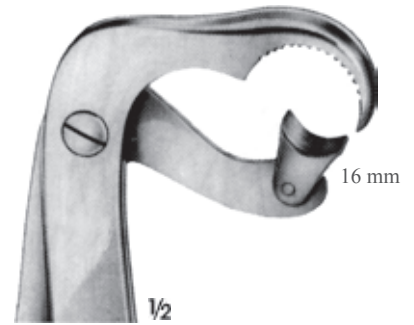
Ayarlanabilir çene  
Adjustable jaw



Haraketli çene  
Movable jaw



58-230  
21.5 cm

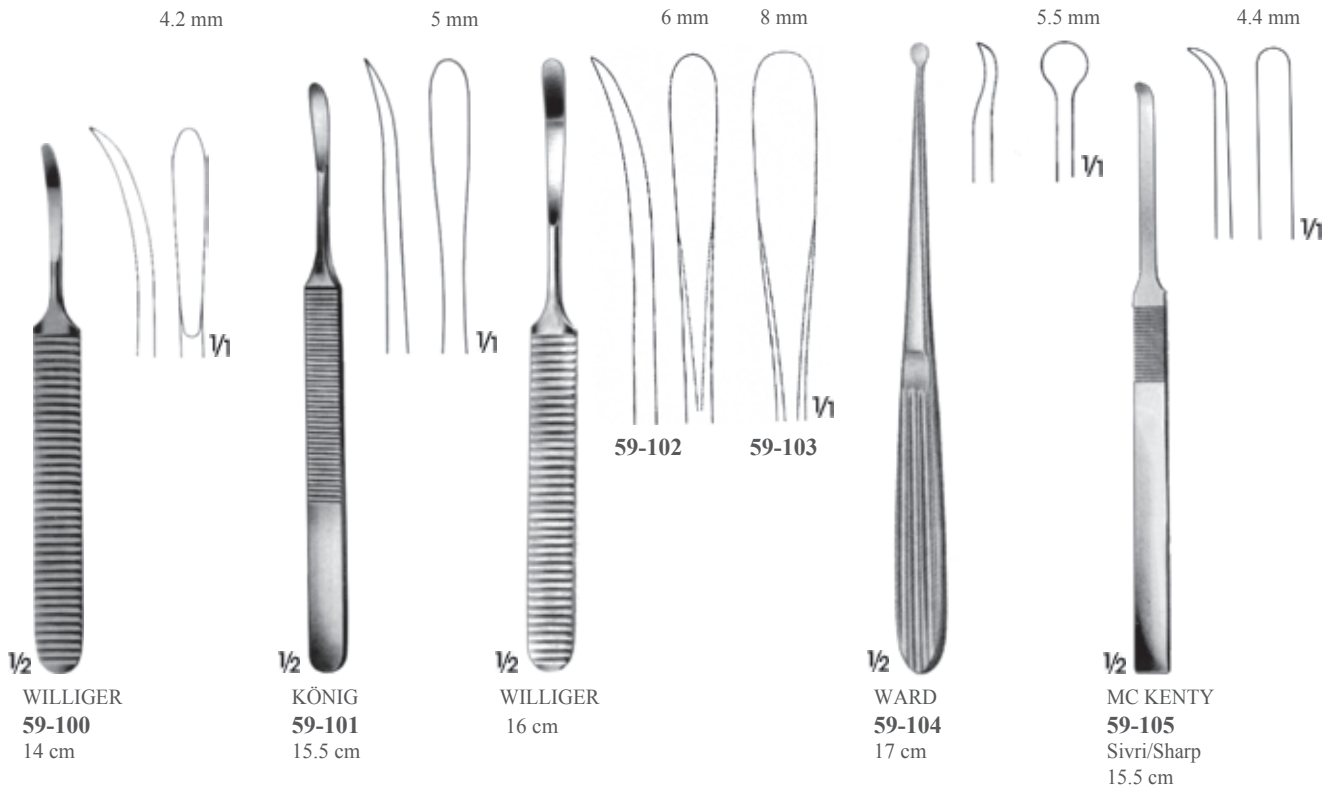


58-231  
27.5 cm





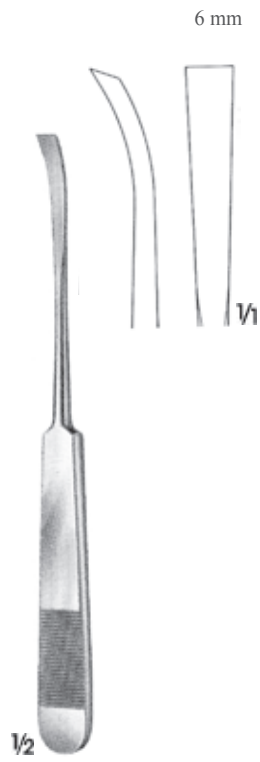
**59**



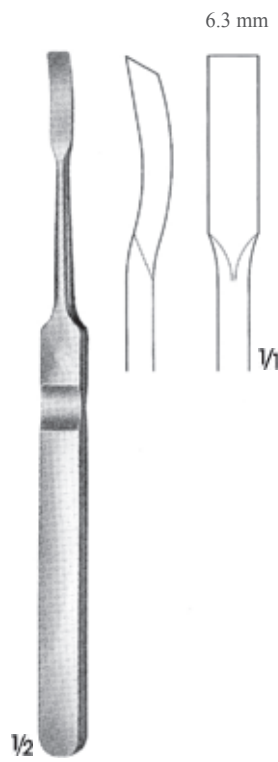




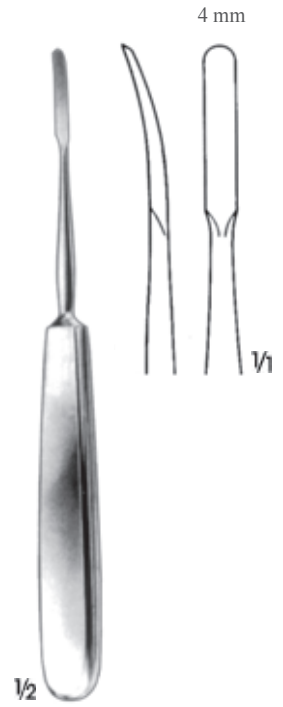
LEMPERT  
**59-111**  
Künt/Blunt  
16.5 cm



PENNYBAKER  
**59-112**  
Künt/Blunt  
16.5 cm



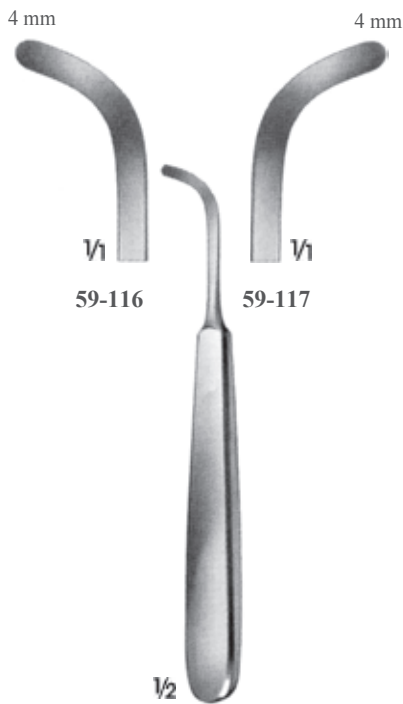
LEMPERT  
**59-113**  
Yarı sivri/Semi-sharp  
18.5 cm



JOSEPH  
**59-114**  
17 cm



TRELAT  
**59-115**  
15 cm



**59-116**

**59-117**

14 cm



ALLEN  
**59-118**  
Osteofit çizil ve raspa  
Osteophyte chisel and scraper  
23 cm



MANNERFELT  
15.5 cm

1/2



59-119  
4 mm  
90°



59-120  
6 mm  
90°



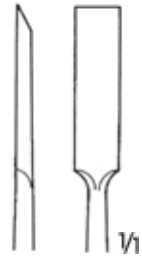
59-121  
3.5 mm  
45°



59-122  
3 mm



59-123  
6 mm



59-124  
6 mm

V1



59-125  
4 mm



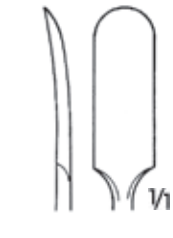
59-126  
5 mm



59-127  
6 mm



59-128  
6 mm



59-129  
8 mm

V1



PAULSEN  
20.5 cm

1/2

5 mm



59-130  
Sivri/Sharp

8 mm



59-131  
Sivri/Sharp

V1



PAULSEN  
20.5 cm

1/2



59-132

2.5 mm

3.5 mm



59-133

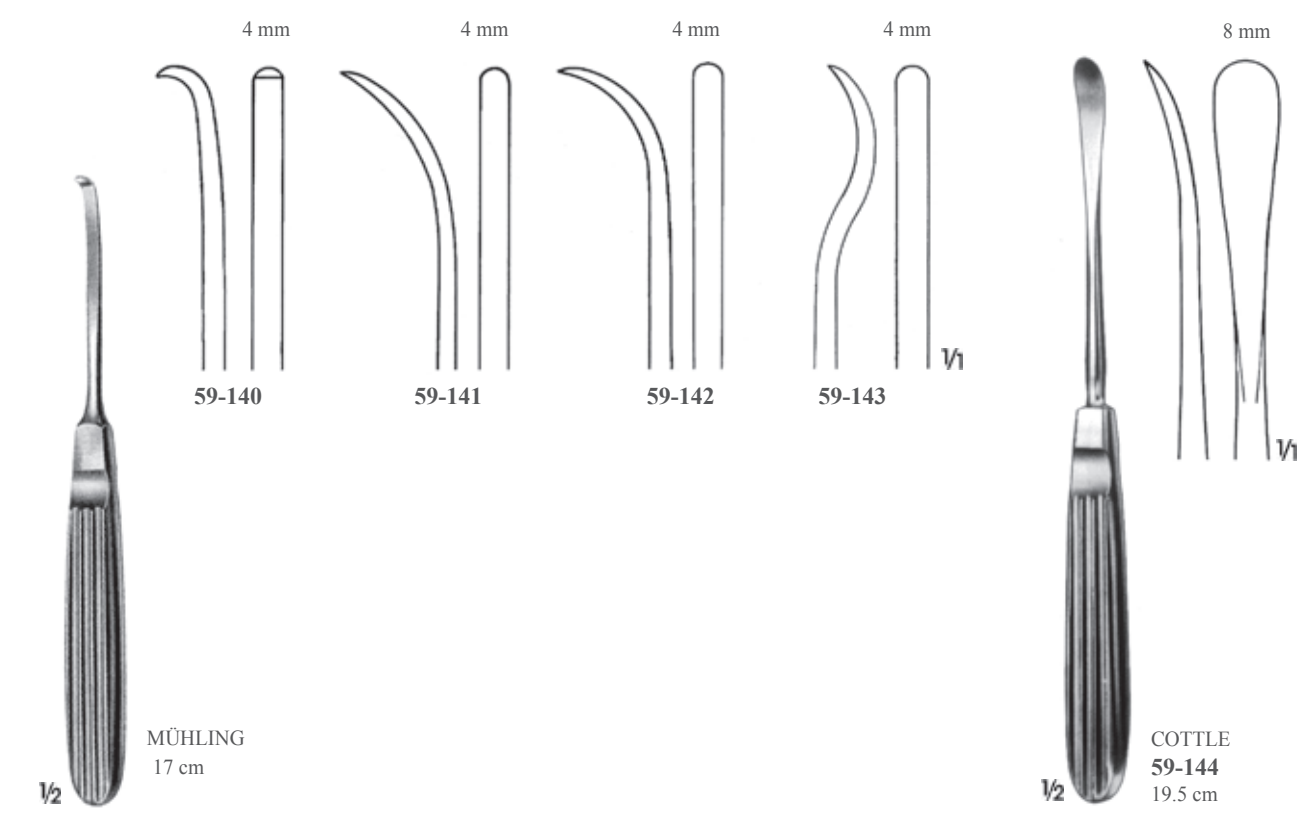
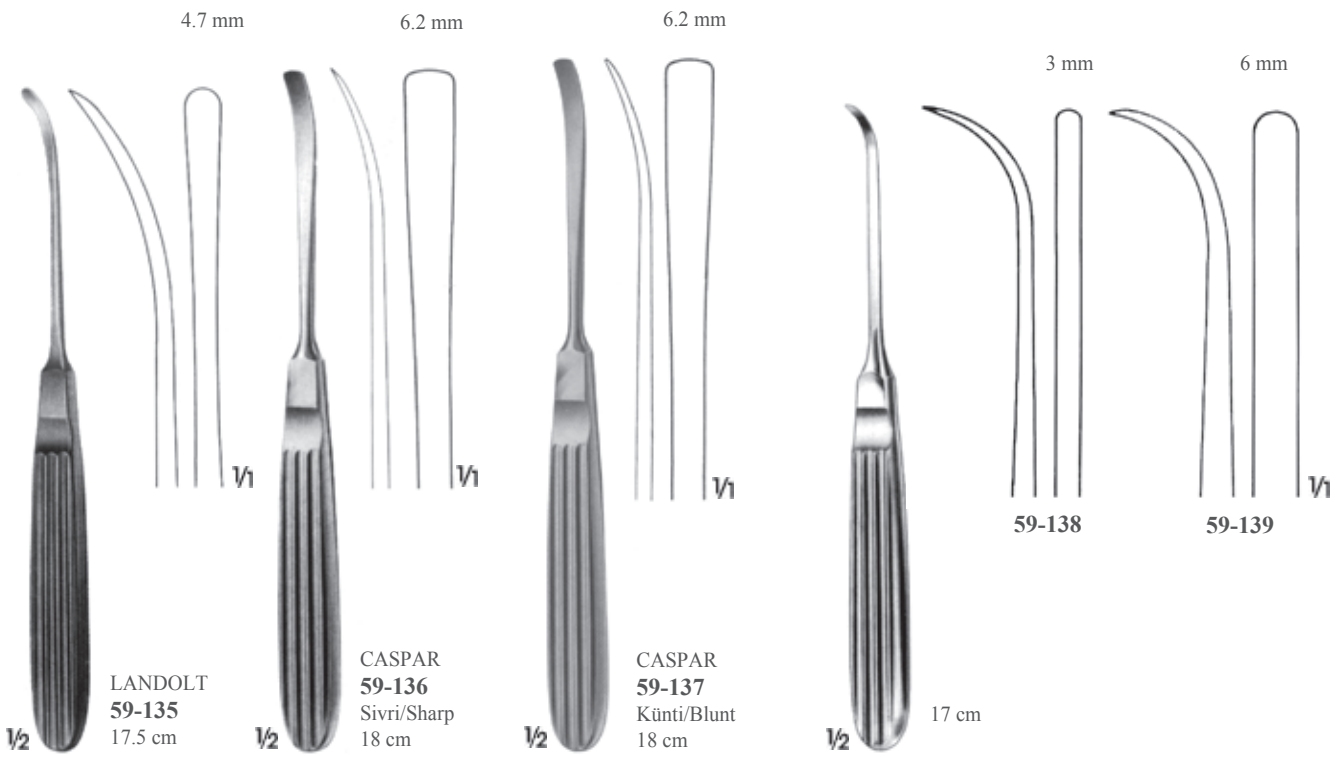
4.5 mm

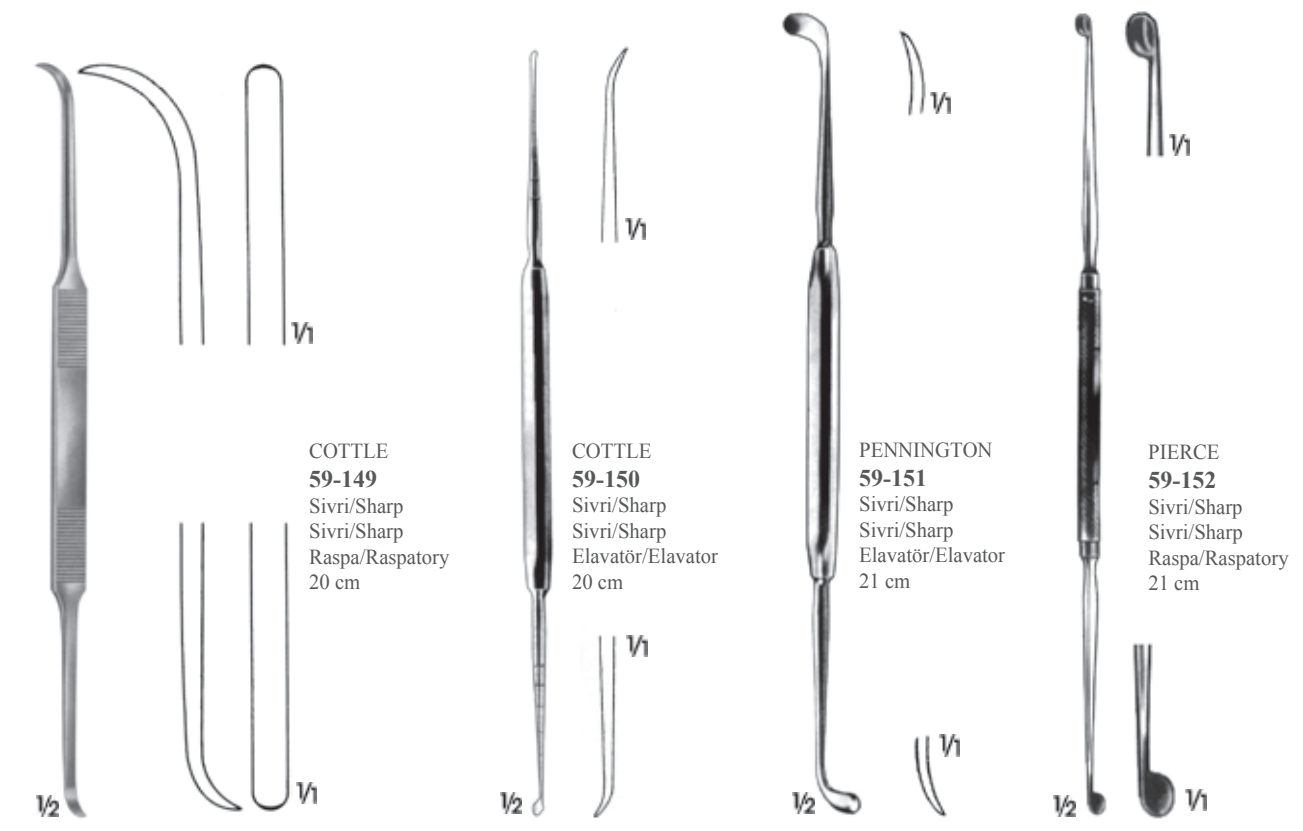


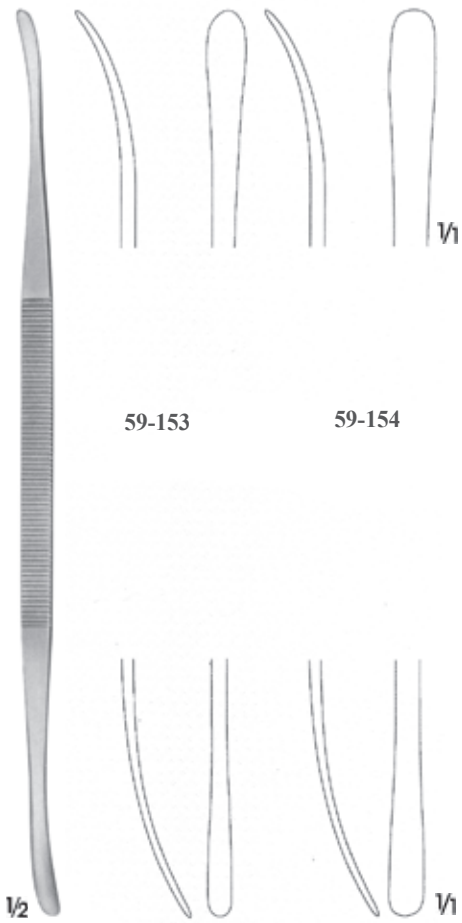
59-134

V1



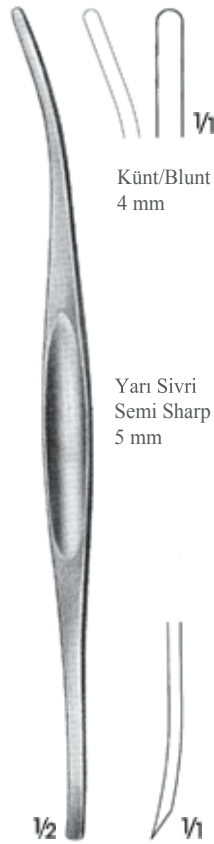






59-153

59-154

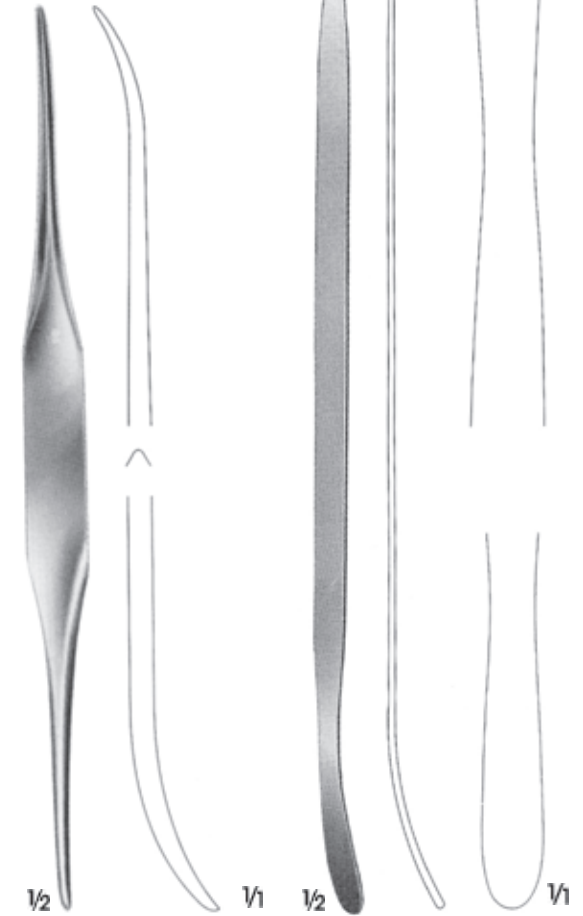


Künt/Blunt  
4 mm

Yarı Sivri  
Semi Sharp  
5 mm

TÖNNIS  
Disektorler/  
Dissectors 24 cm

HILL  
59-155  
Raspa/Raspatory  
Yarı sivri/Künt  
Semi-sharp/Blunt  
22 cm



TÖENNIS  
59-156  
Oluklu disektör  
Grooved director  
24 cm

PENFIELD  
59-157 Disektor/Dissector  
Çif uçlu, hafif eğri  
Double-ended, slightly curved  
29 cm





**FRAZIER**  
**59-158**  
Raspa/Raspatory  
15 cm



**HOEN**  
**59-159**  
Raspa/Raspatory  
15 cm



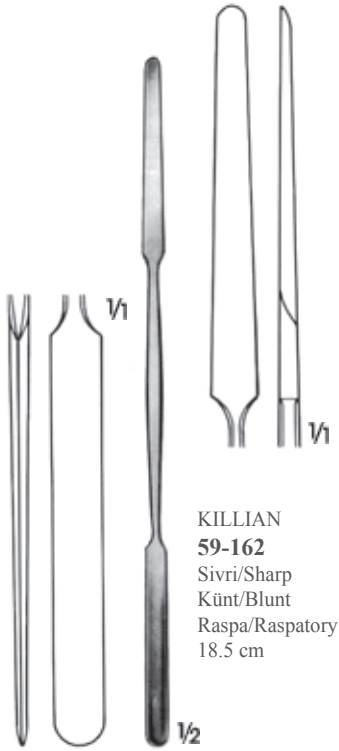
**HOEN**  
**59-160**  
Raspa/Raspatory  
15 cm



Sivri/Sharp

Künt/Blunt

**FREER**  
**59-161**  
Raspa/Raspatory  
20 cm



**KILLIAN**  
**59-162**  
Sivri/Sharp  
Künt/Blunt  
Raspa/Raspatory  
18.5 cm



**O'CONNELL**  
**59-163**  
Disektor/Dissector  
Çif uçlu  
Double-Ended  
22 cm



**MILLIGAN**  
**59-164**  
Raspa/Raspatory  
21 cm



**WOODSON**  
**59-165**  
Raspa/Raspatory  
25 cm



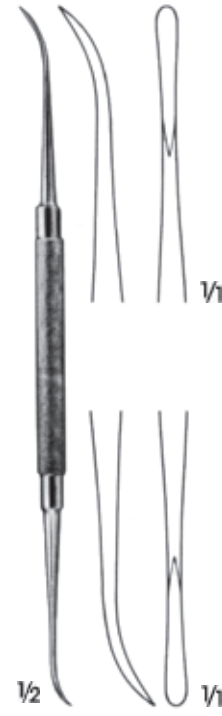
FREER  
**59-166**  
Sivri/Sharp  
Raspa/Raspatory  
19 cm



FREER  
**59-167**  
Künt/Blunt  
Raspa/Raspatory  
19 cm



FREER  
**59-168**  
Sivri/Künt  
Sharp/Blunt  
Raspa/Raspatory  
18.5 cm



FREER-YASARGIL  
**59-169**  
Sivri/Sharp  
Sivri/Sharp  
Raspa/Raspatory  
18.5 cm



SWEDISH  
**59-170** 18 cm  
Hafif model disektör  
Light pattern dissector  
**59-171** 20 cm Sert  
model disektör Heavy  
pattern dissector



PENNYBACKER  
**59-172**  
Prob dissektor  
Probe dissector  
23 cm

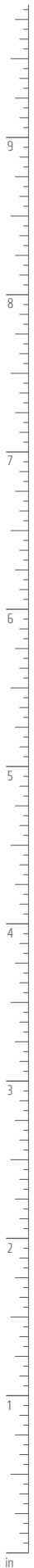


DAVIS  
**59-173**  
Dissektor  
Dissector  
24.5 cm



DAVIS  
**59-174**  
Raspa  
Raspator  
24 cm





SEWALL  
**59-175**  
Künt/Blunt  
Raspa/Raspatory  
20 cm



CASPAR  
**59-176**  
Raspa/Raspatory  
20 cm



PENFIELD  
**59-177**  
Raspa/Raspatory  
20.5 cm



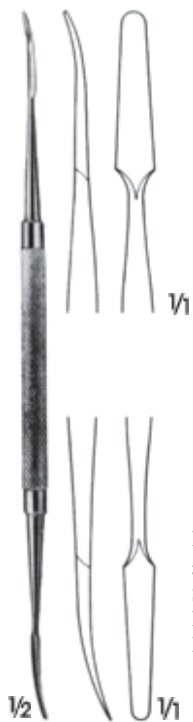
SACHS  
**59-178**  
Raspa/Raspatory  
21 cm



CASPAR  
**59-179**  
Disektor/Dissector  
23 cm



HALLE  
**59-180**  
Künt/Blunt  
Raspa  
Raspatory  
18 cm



KILLIAN  
**59-181**  
Sivri/Sharp  
Künt/Blunt  
Raspa/Raspatory  
18.5 cm



HOWARTH  
**59-182**  
Sivri/Sharp  
Künt/Blunt  
Raspa/Raspatory  
21.5 cm

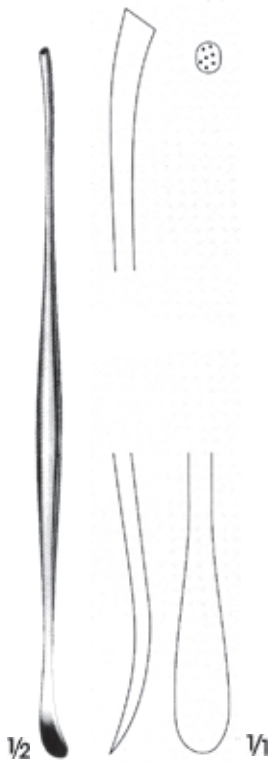


**59-183**  
Disektor  
Dissector  
22 cm

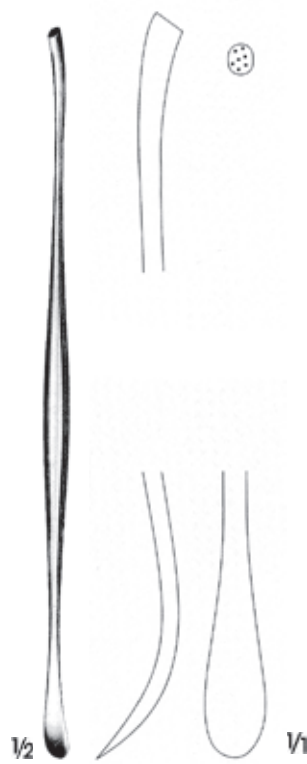


**59-184**  
Raspa  
Raspatory  
22 cm

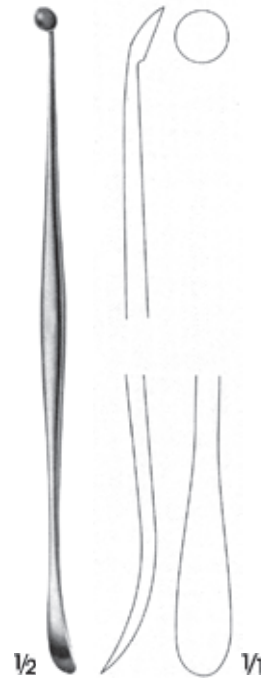




PENFIELD  
**59-185** Fig.2  
Disektor/Dissector  
Çif uçlu/Double-Ended  
19.5 cm



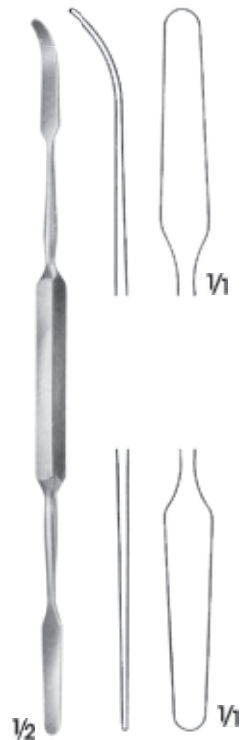
PENFIELD  
**59-186** Fig.3  
Disektor/Dissector  
Çif uçlu/Double-Ended  
19.5 cm



PENFIELD  
**59-187**  
Disektor/Dissector  
Çif uçlu/Double-Ended  
17.5 cm



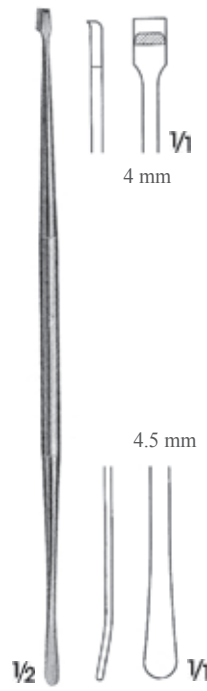
CARTER  
**59-188**  
Raspa/Raspatory  
21 cm



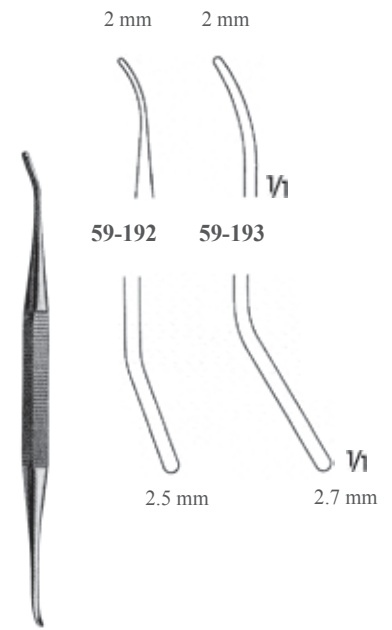
MAC DONALD  
**59-189**  
Künt/Blunt  
Künt/Blunt  
Dissektor/ Dissector  
18.5 cm



SYME  
**59-190** Sivri/Sharp  
Raspa/Raspatory  
18.5 cm

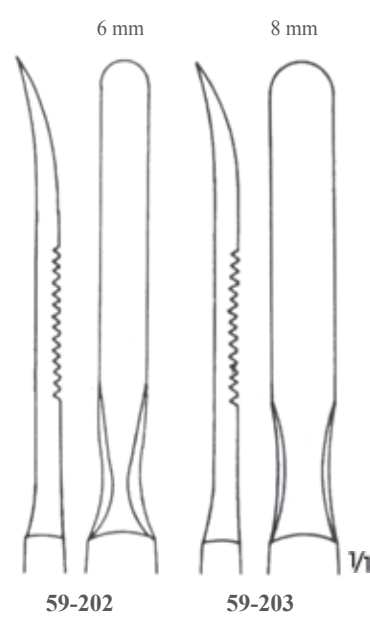
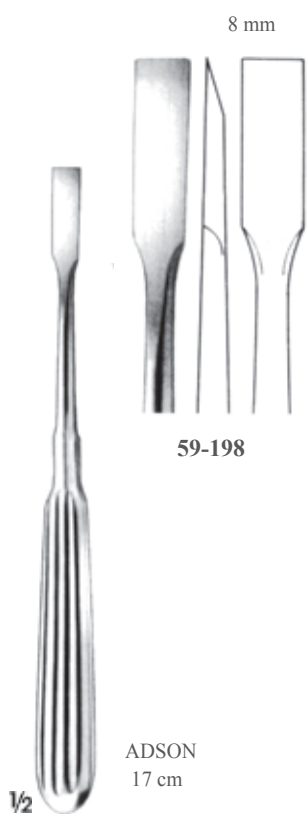
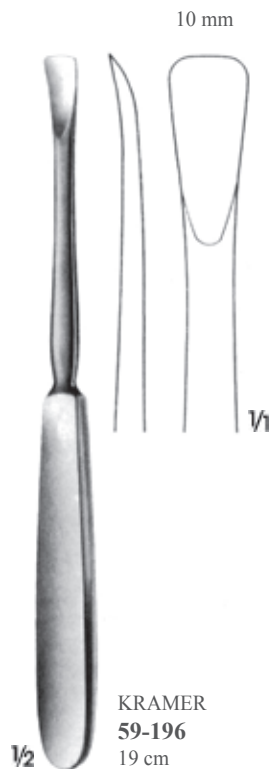


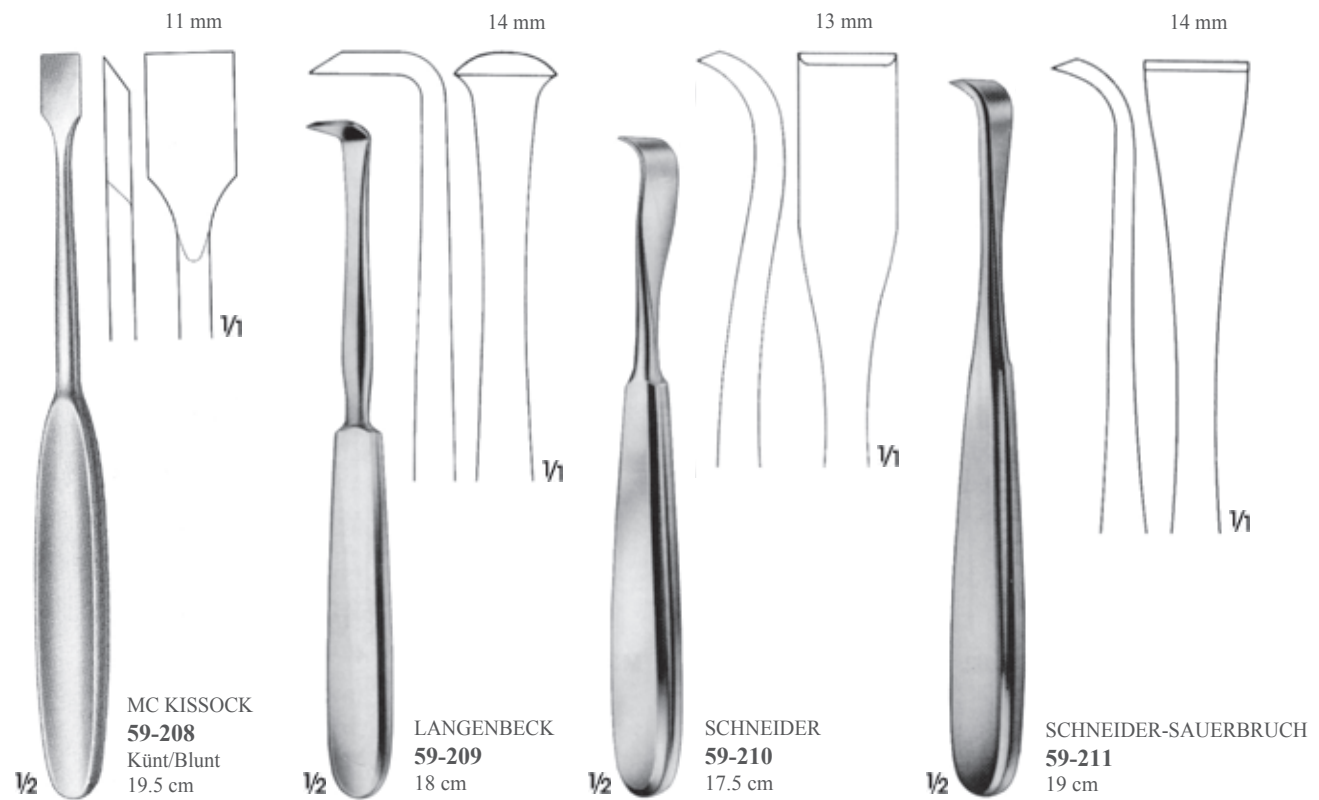
FREER  
**59-191**  
Raspa/Raspatory  
18 cm

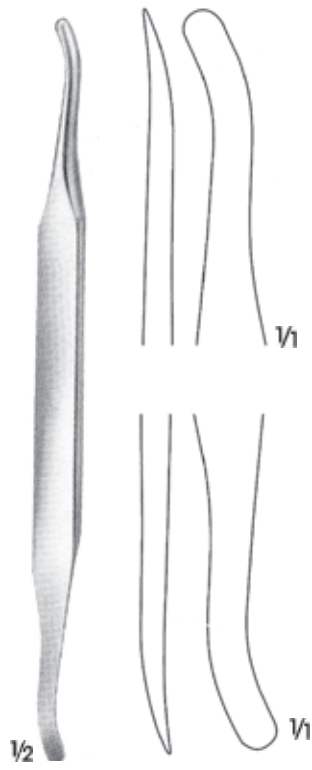


WATSON-CHEYNE  
**59-192** 13 cm  
**59-193** 19 cm  
Raspalar/Raspatory

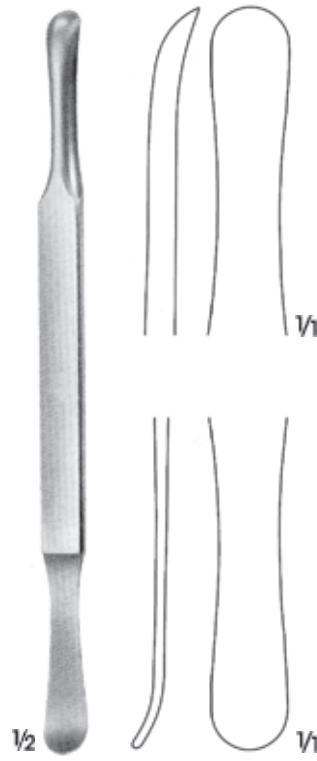




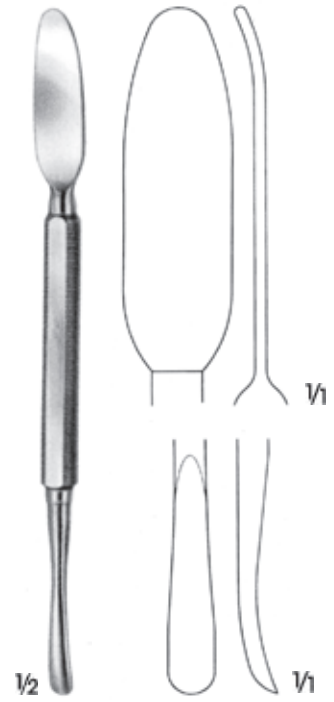




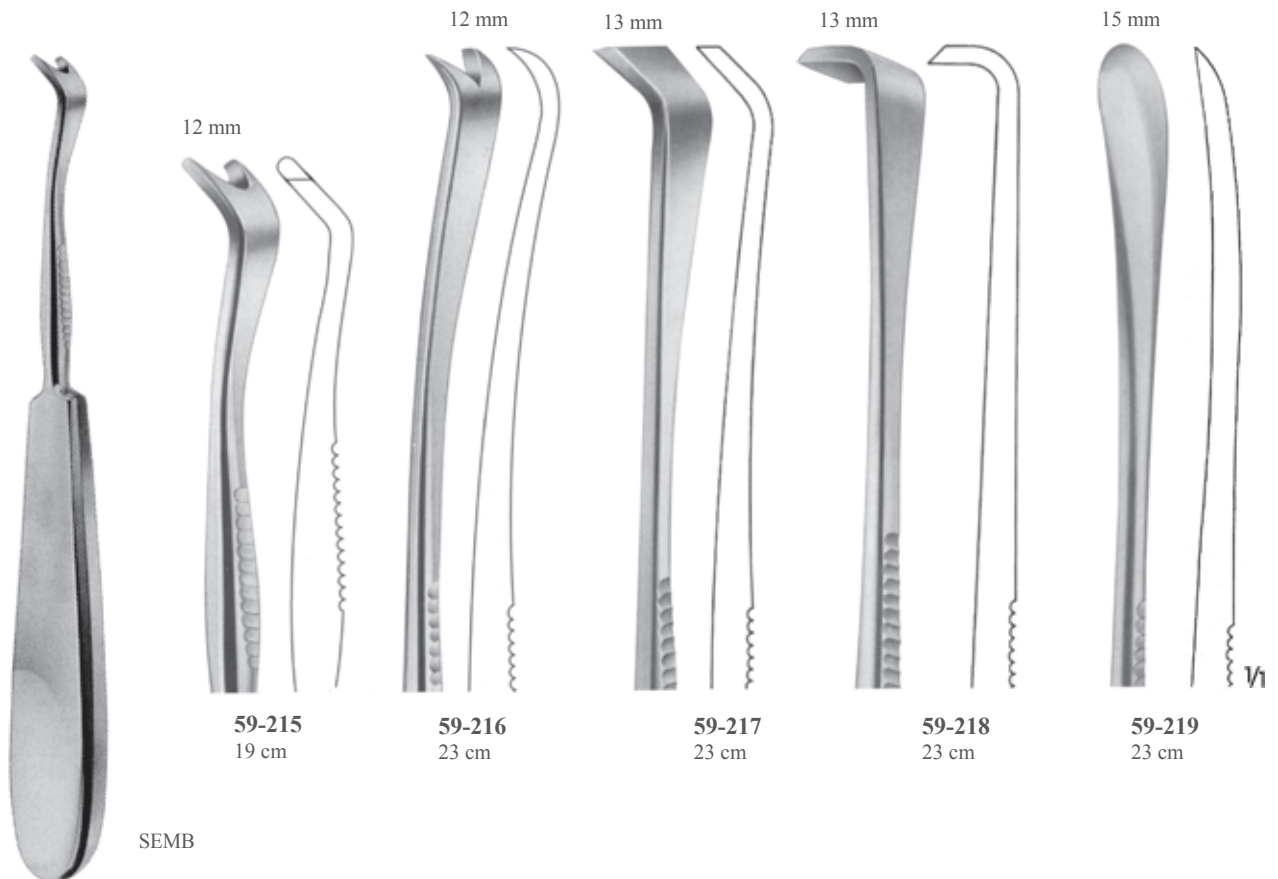
**SELDIN**  
**59-212**  
19.5 cm



**SELDIN**  
**59-213**  
19.5 cm



**ROBERTS**  
**59-214**  
Künt/Blunt  
18.5 cm



**SEMB**

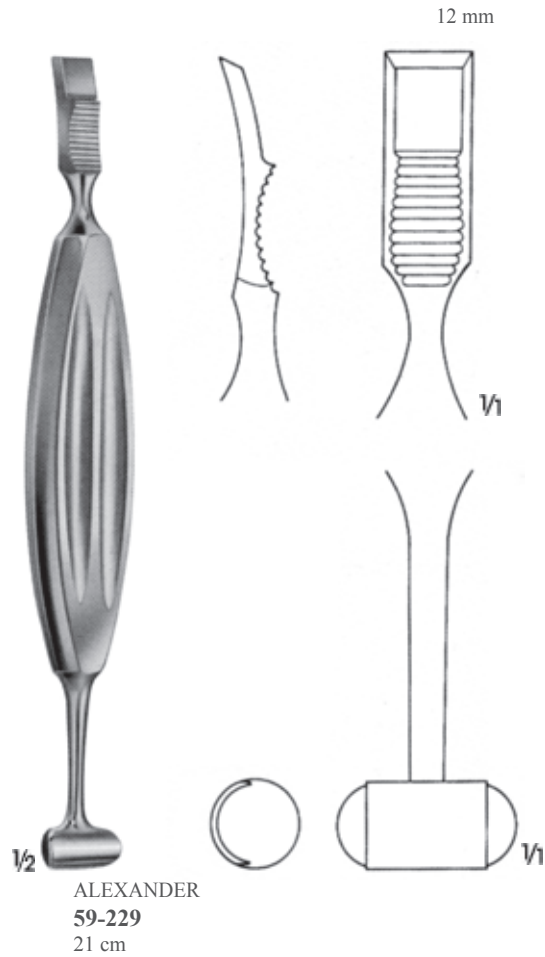
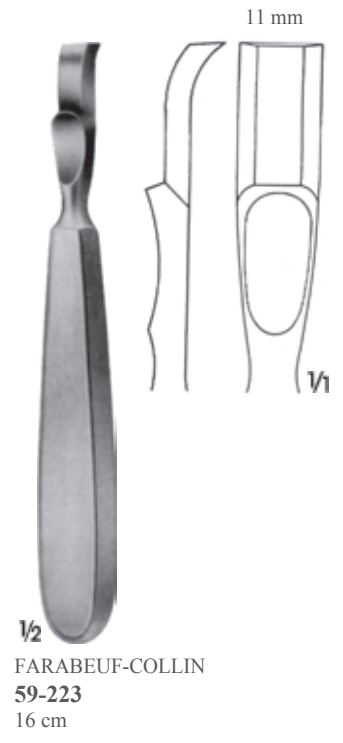
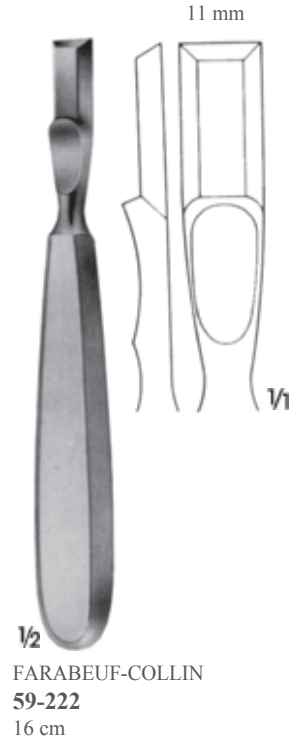
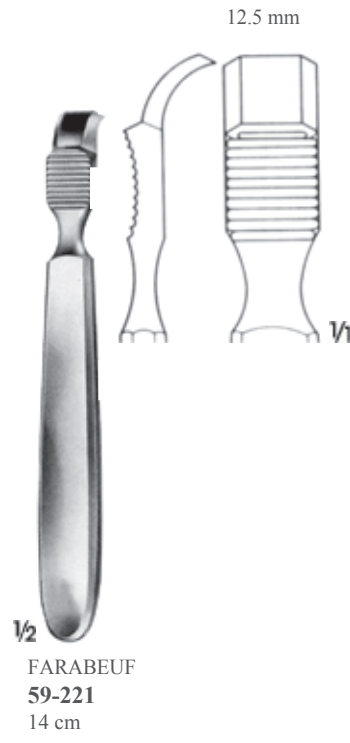
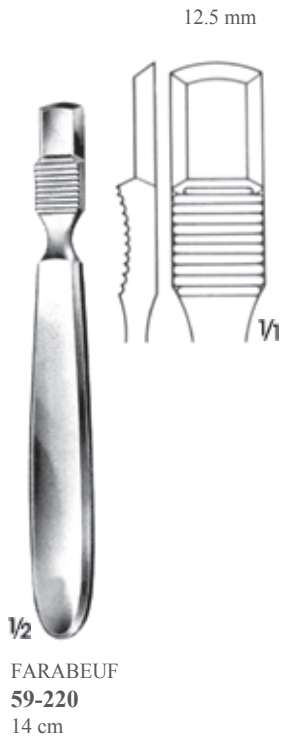
**59-215**  
19 cm

**59-216**  
23 cm

**59-217**  
23 cm

**59-218**  
23 cm

**59-219**  
23 cm





8 mm



59-232

19 mm



59-235

6 mm



59-231

13 mm



59-234

4 mm



59-230

10 mm



59-233



1/2

COBB

27 cm



1/2

COBB

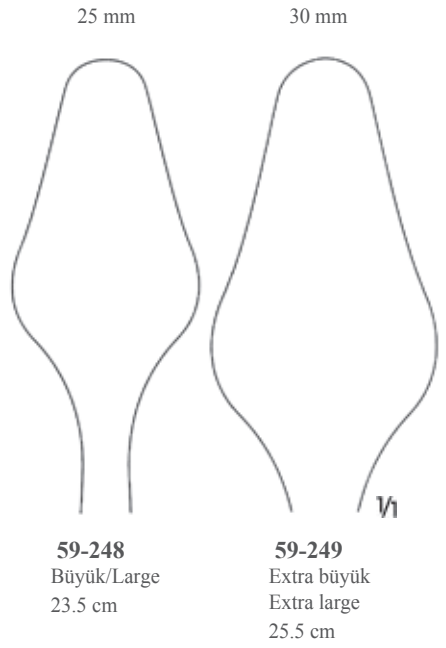
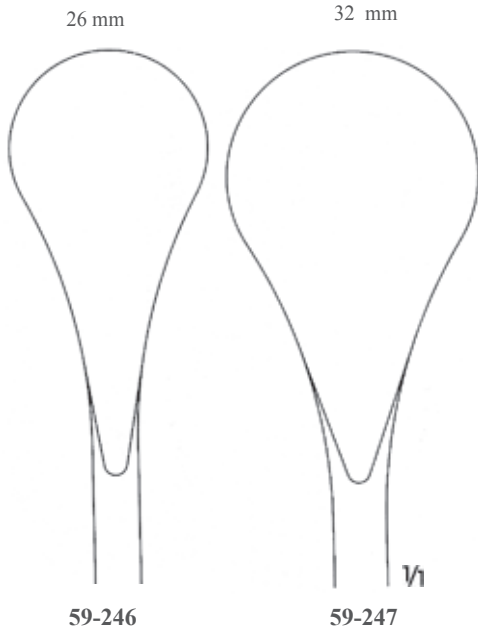
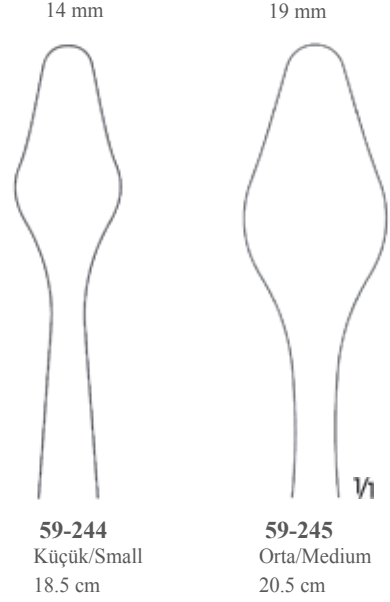
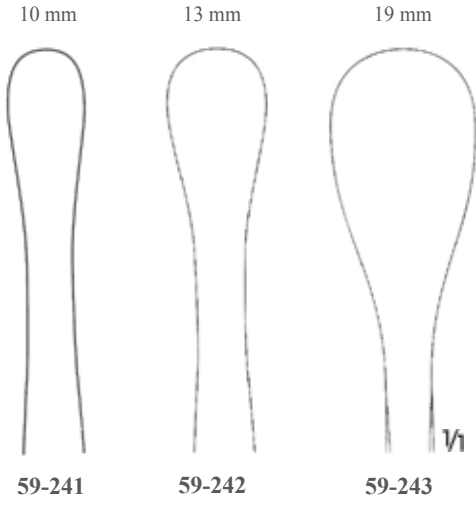
24 cm



KEY

Genişlik Boy  
Wid th Uzunluk

59-236	6 mm	18 cm
59-237	10 mm	19 cm
59-238	13 mm	19 cm
59-239	19 mm	20 cm
59-240	25 mm	21 cm



COBB

Raspa/Raspatory  
28 cm



CHANDLER

Elevatör/Elevators





143° buhar sterilizörlerinde steril edilebilir.  
Can be sterilized in a steam sterilizer up to 143°



**59-250**  
19 cm



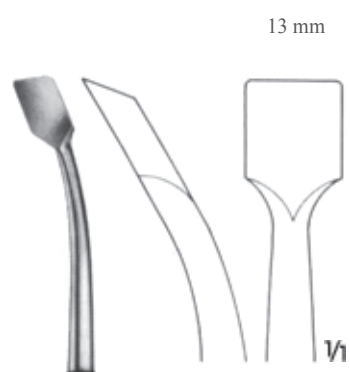
**59-251**  
18.5 cm



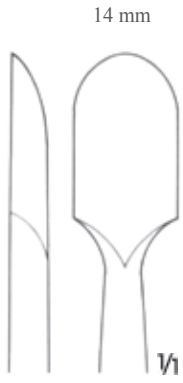
**59-252**  
19 cm



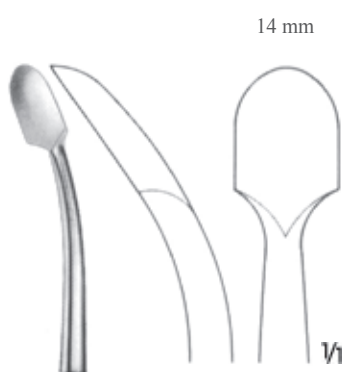
**59-253**  
19 cm



**59-254**  
17.5 cm



**59-255**  
19 cm



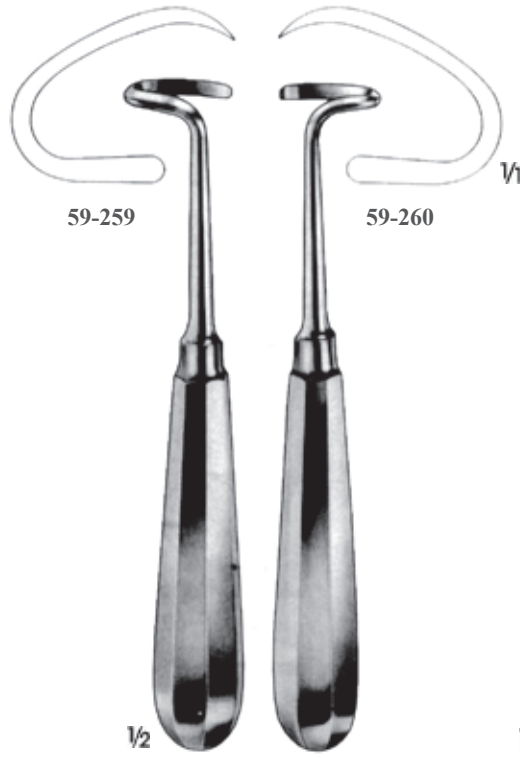
**59-256**  
18 cm





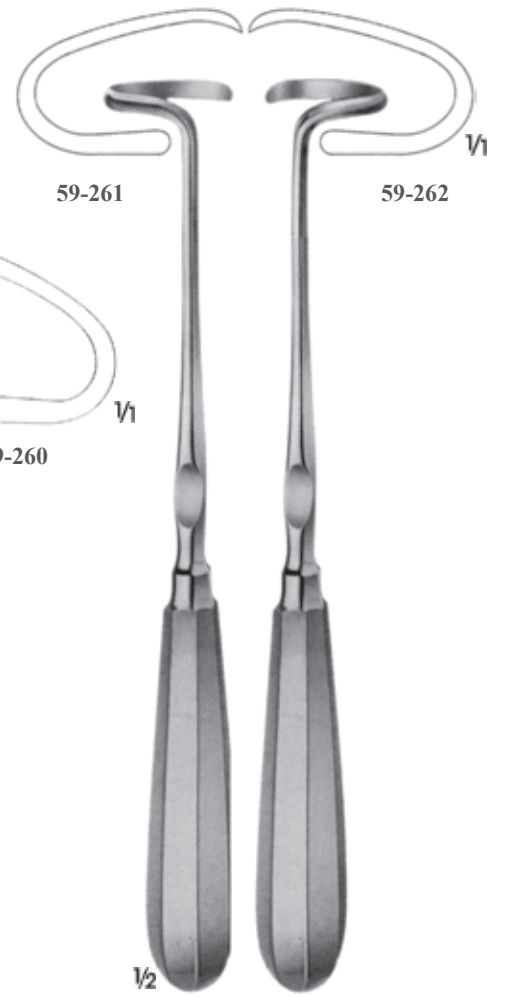
DOYEN

Çocuklar için/For children  
17.5 cm



DOYEN

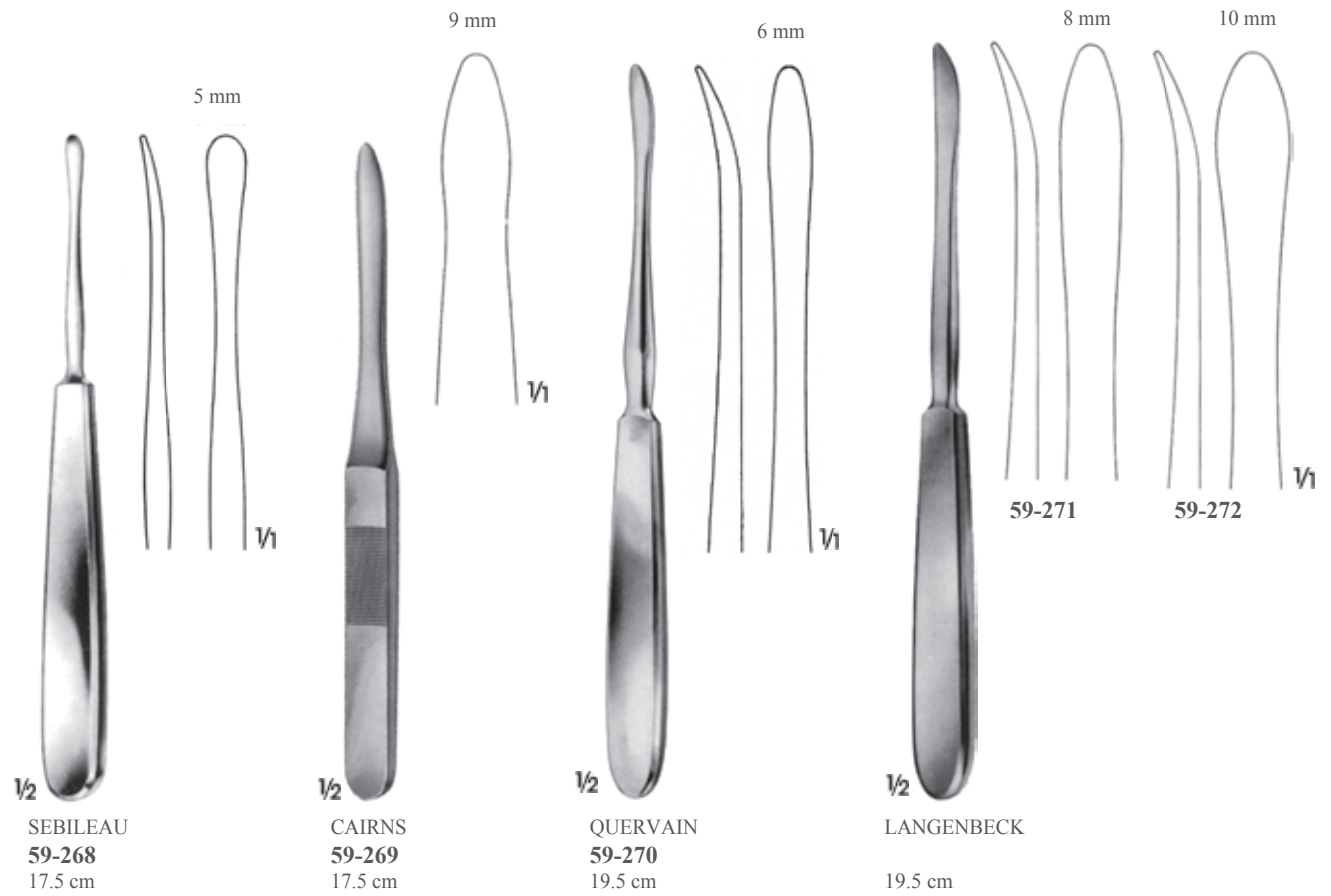
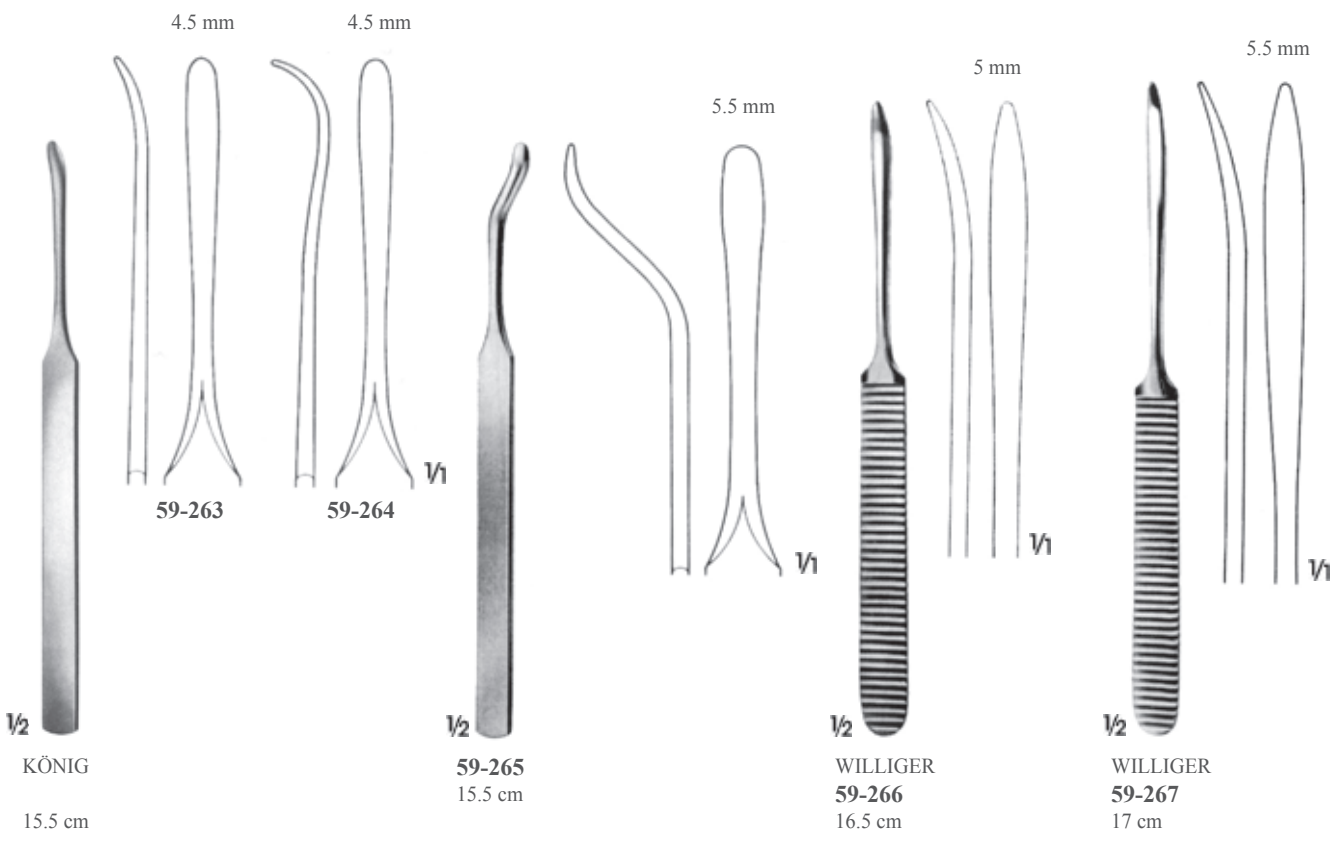
Yetişkimler için/For adults  
17.5 cm



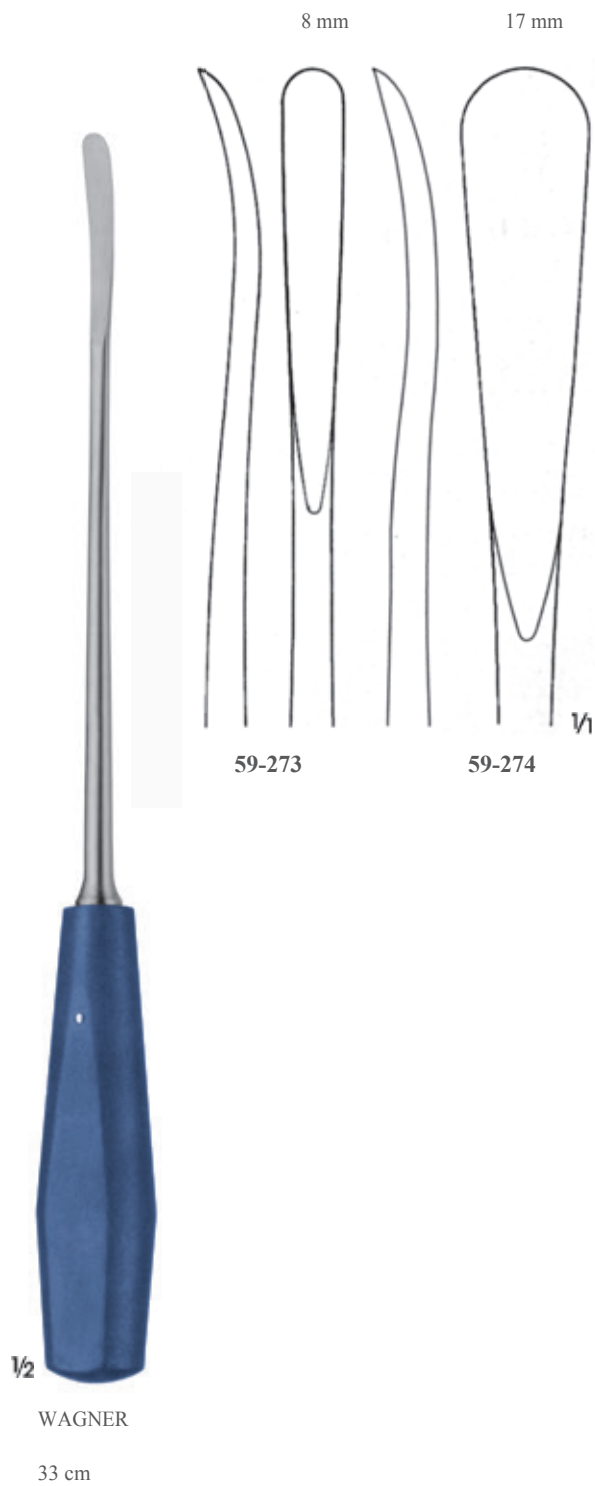
DOYEN

24 cm





143 ° buhar sterilizatörlerin de steril edilebilir.  
Can be sterilized in a steam sterilizer up to 143 °

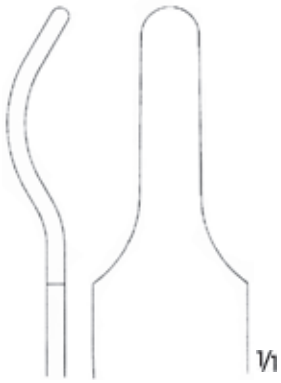






1/2

VATSON-JONES  
59-281  
28 cm



1/1



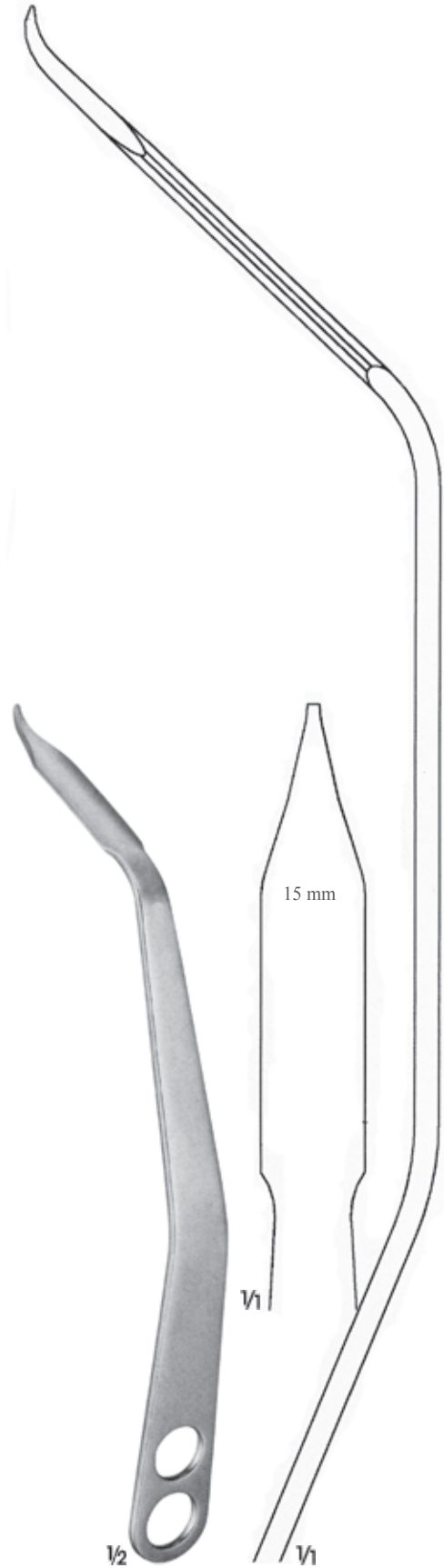
1/2

59-282  
22 cm

8 mm

1/1

1/1



1/2

59-283  
25 cm

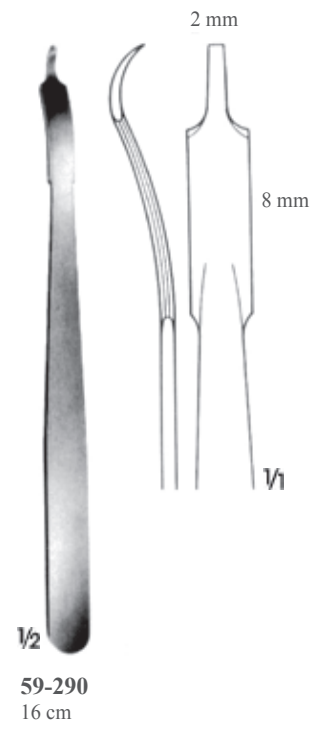
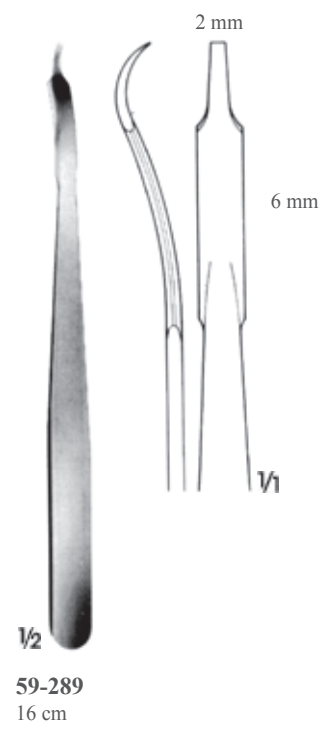
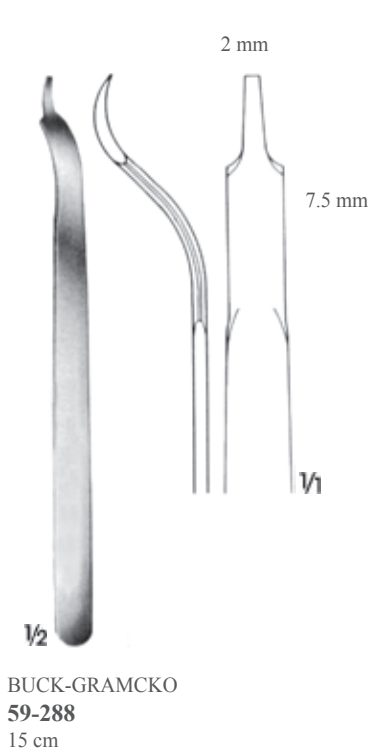
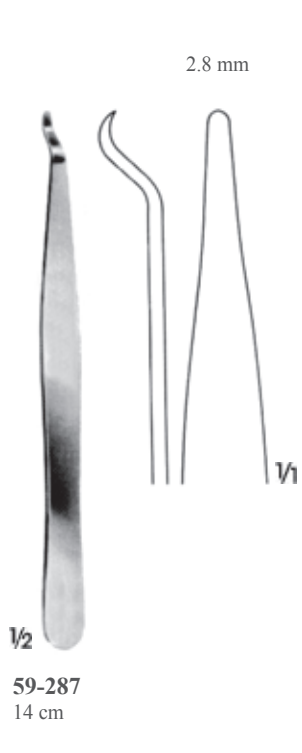
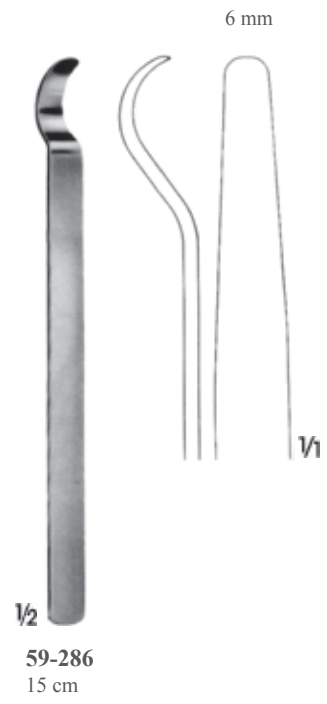
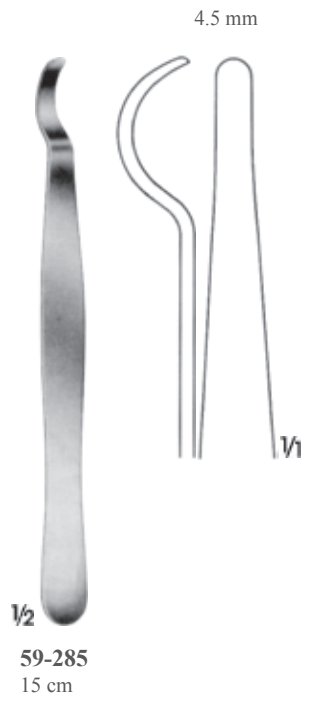
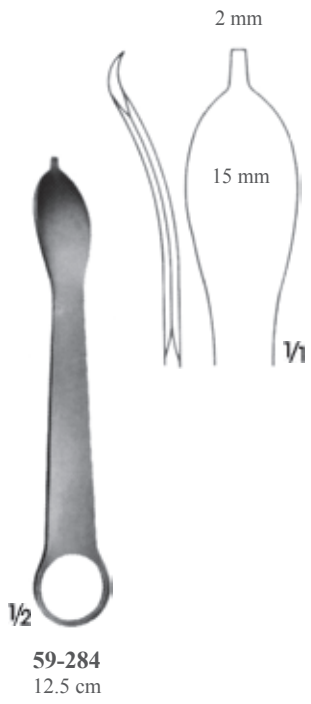
15 mm

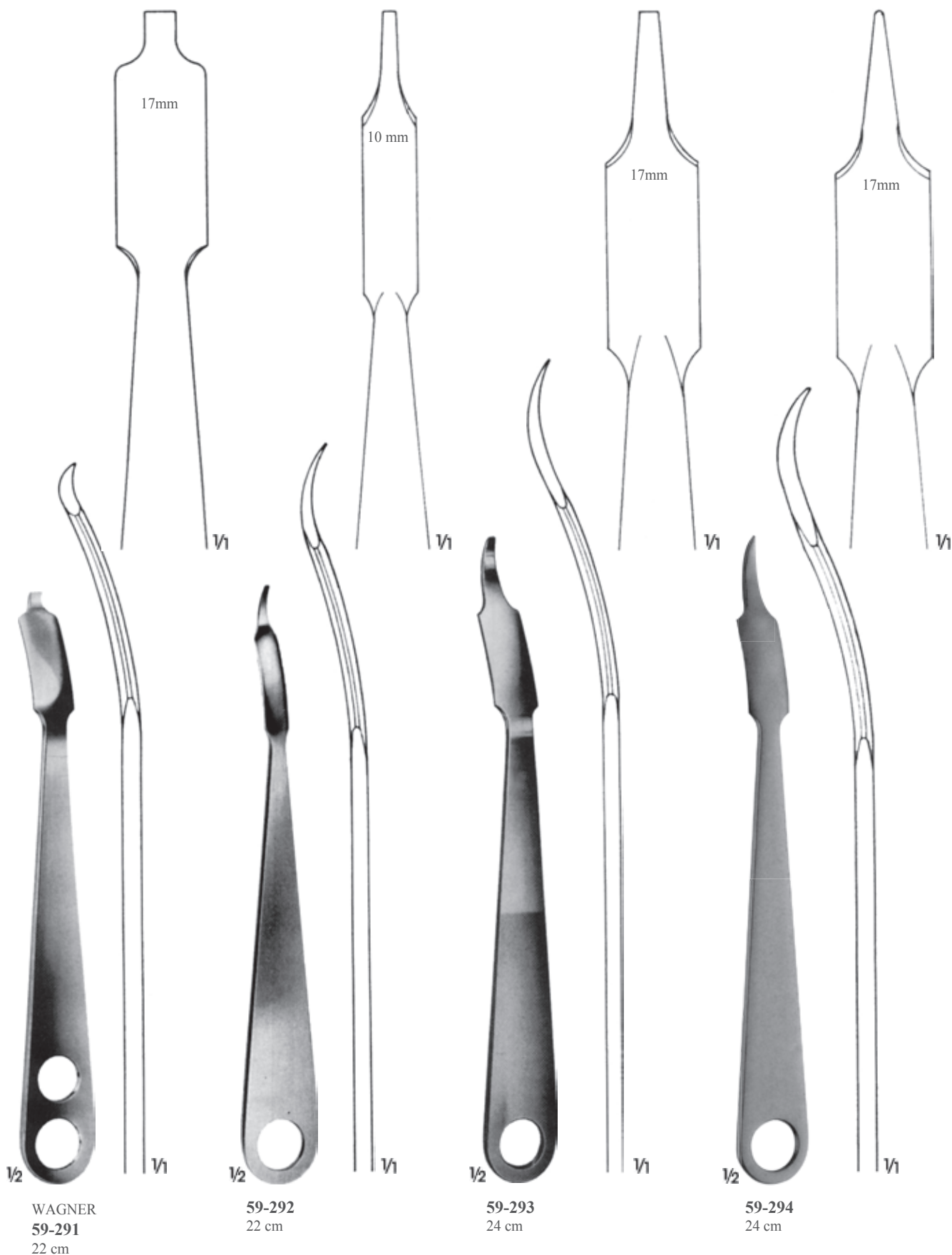
1/1

1/1



cm





WAGNER  
59-291  
22 cm

59-292  
22 cm

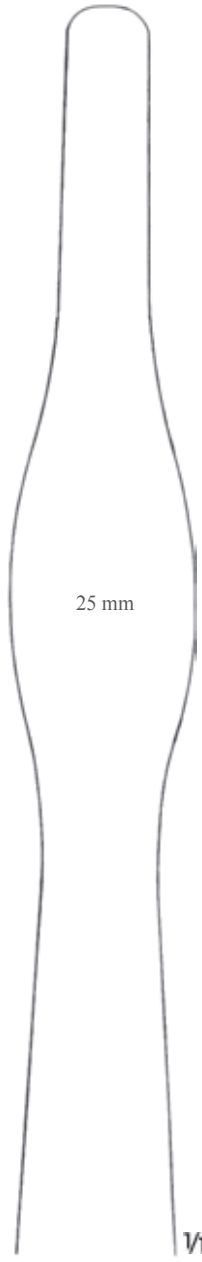
59-293  
24 cm

59-294  
24 cm



1/2

59-295  
26 cm



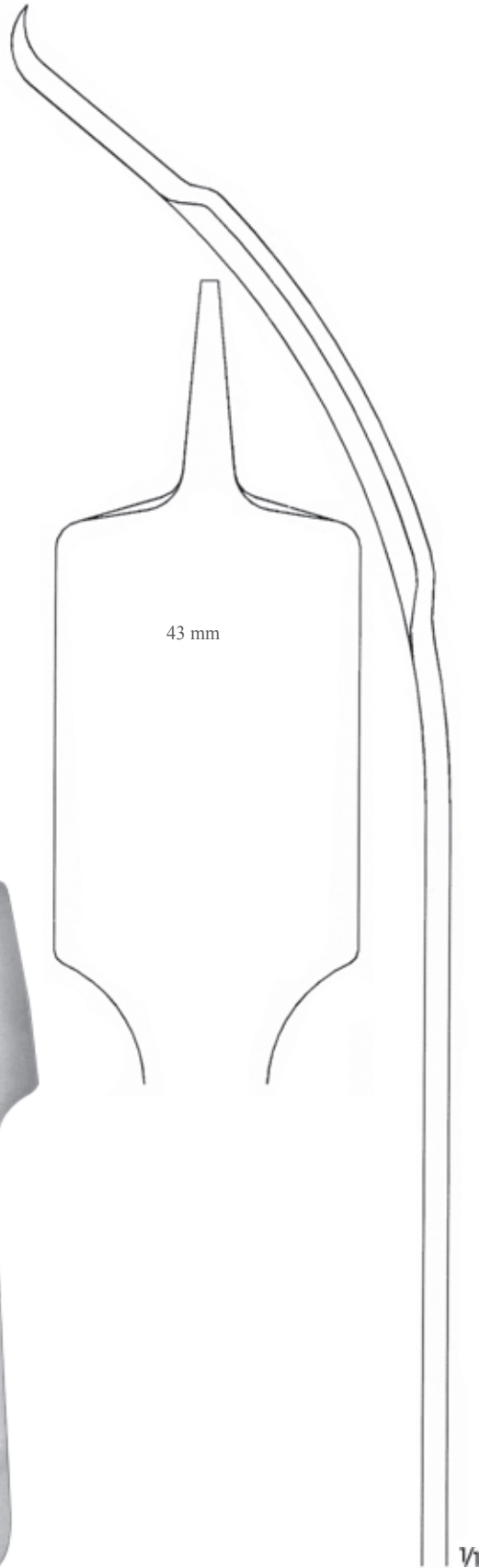
25 mm

1/1



1/2

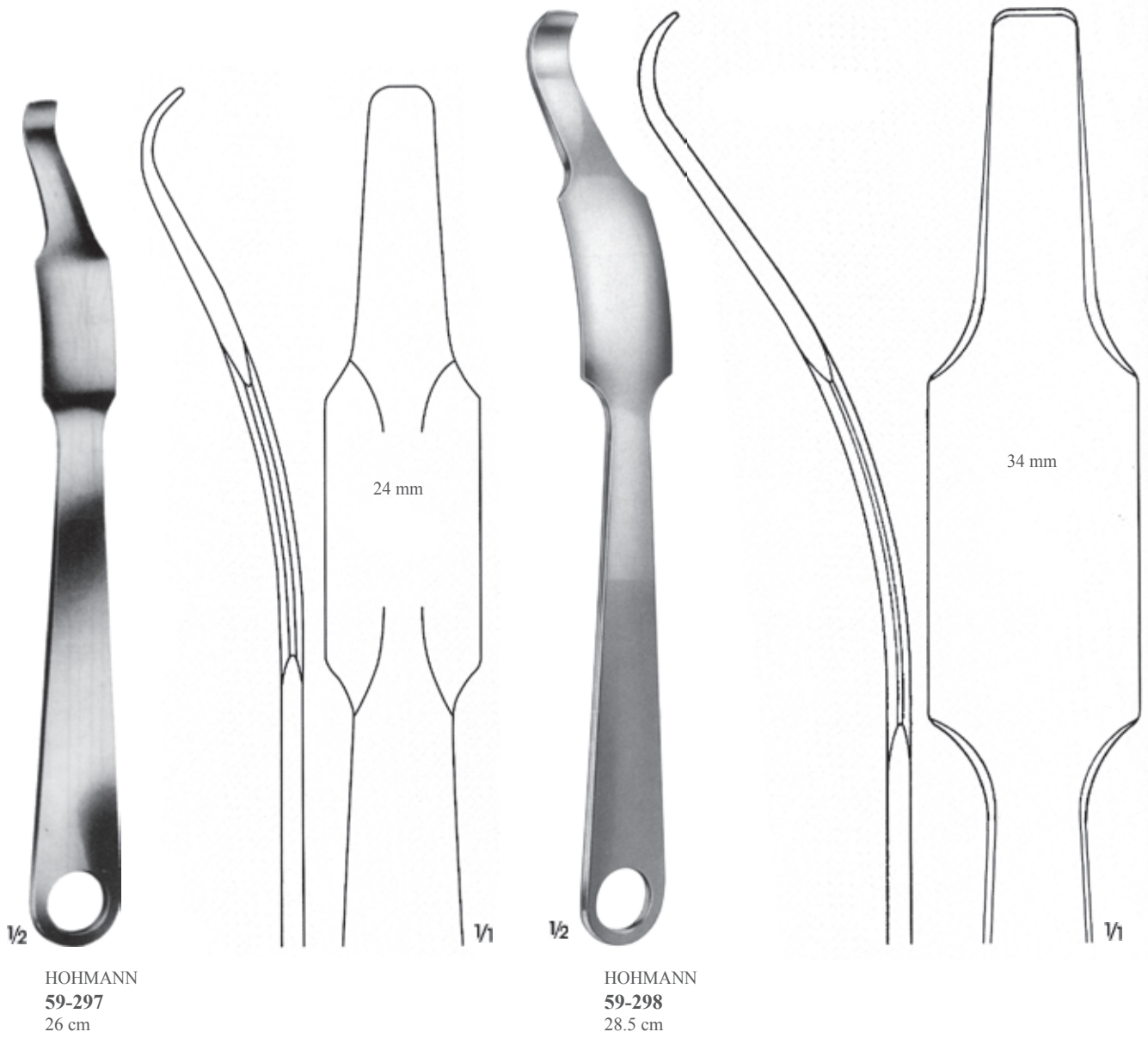
59-296  
23 cm



43 mm

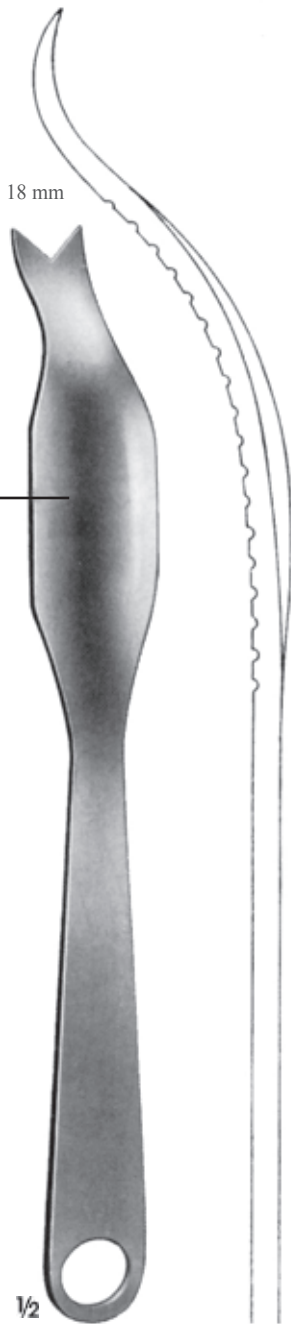
1/1



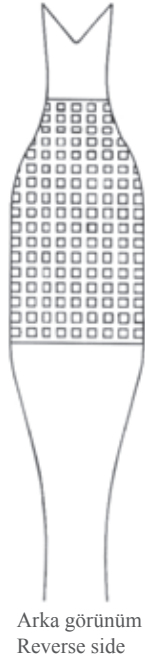


1/2  
HOHMANN  
59-297  
26 cm

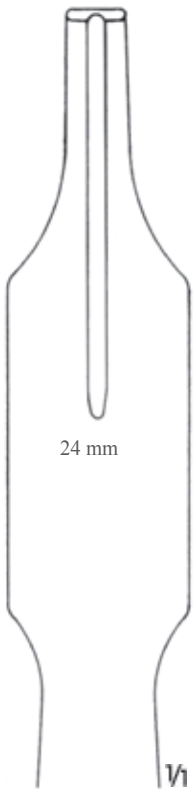
1/2  
HOHMANN  
59-298  
28.5 cm



SCHUMACHER  
59-299  
29 cm



SCHUMACHER-WAGNER  
59-300  
35.5 cm



24 mm

1/1

1/2

LANGE-HOHMANN  
59-301  
25 cm



59-302  
30 mm

59-303  
33 mm

1/1

1/2

LANGE-HOHMANN  
26.5 cm // 28 cm

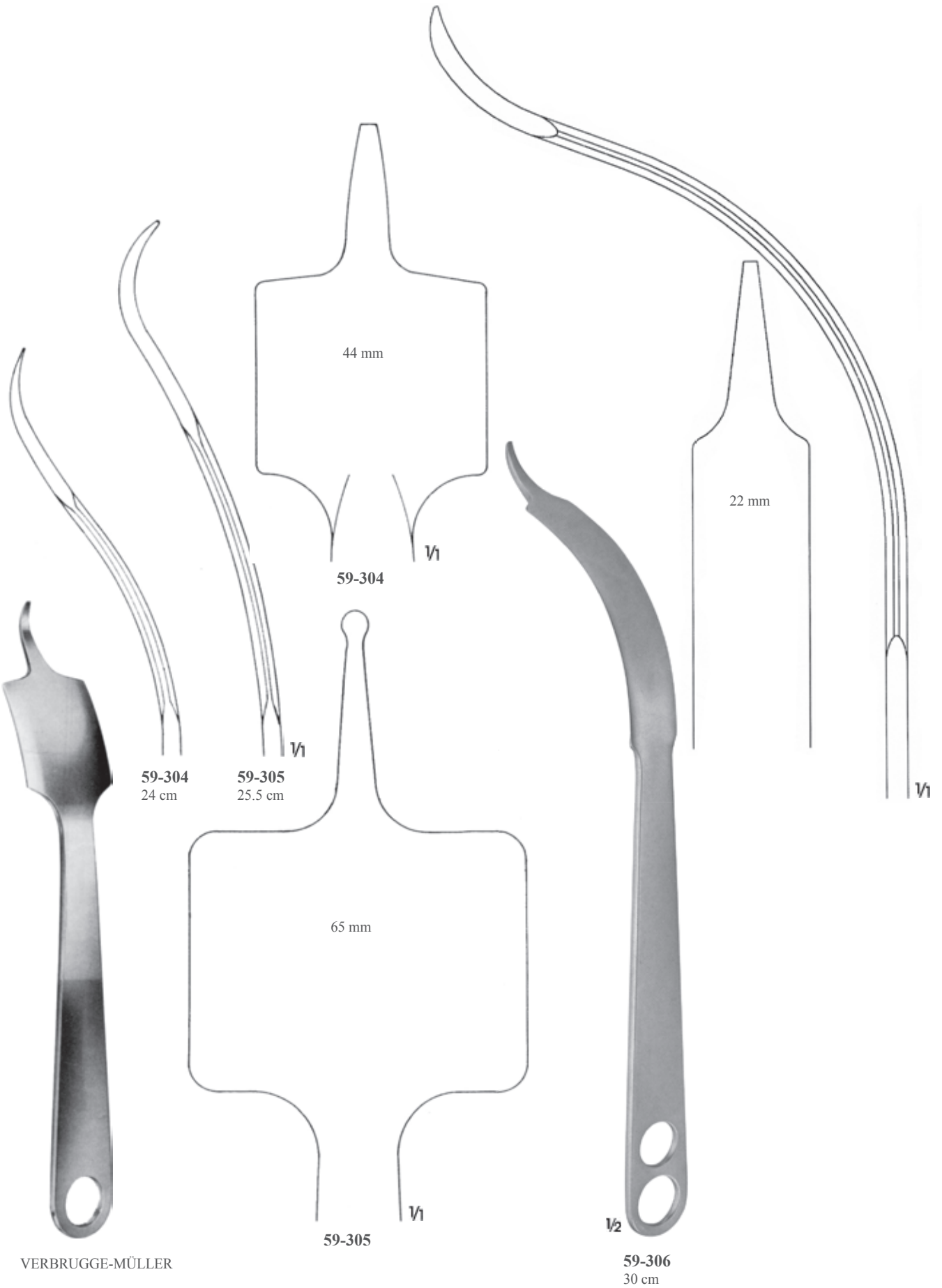


59-302

59-303

1/1





VERBRUGGE-MÜLLER



**59-307**  
32 cm



**59-308**  
32 cm

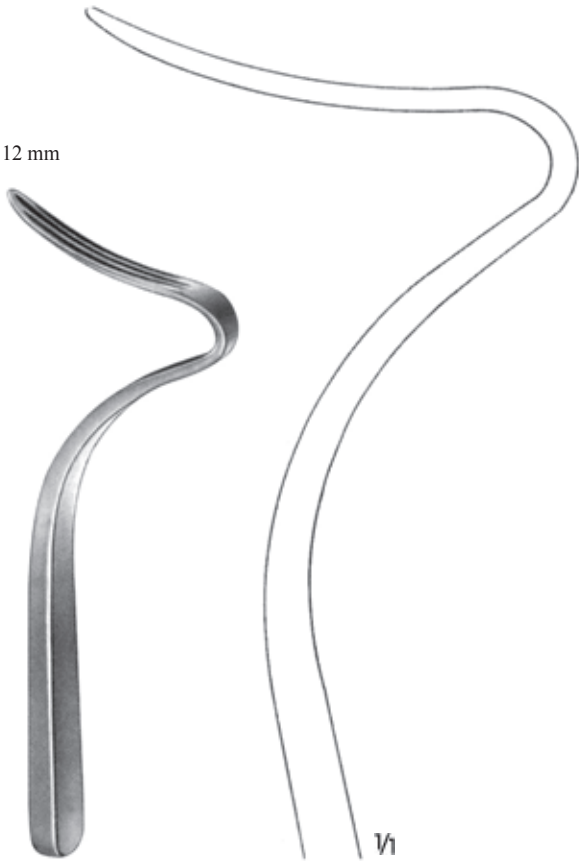


**59-309**  
Femur ekartörü  
Femoral retractor  
38 cm





12 mm

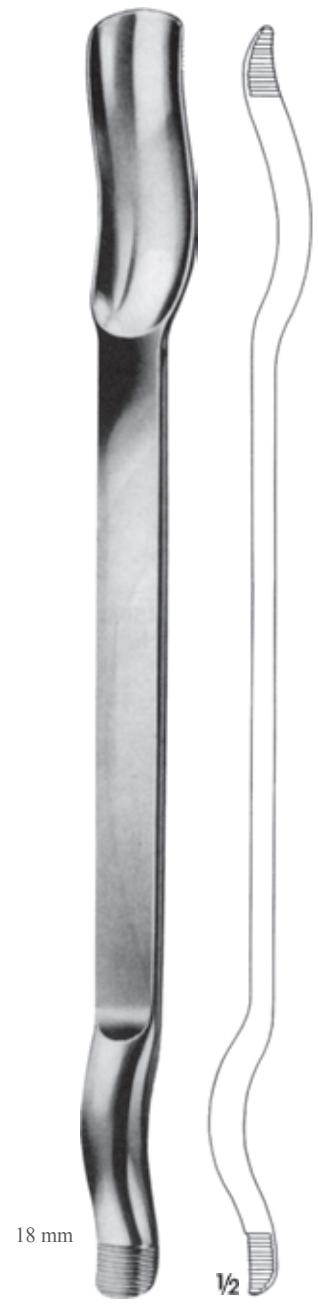


**TAGER**  
**59-310**  
Mafsal elevatör  
Bone lever for angle joint operations  
17.5 cm



**BLOUNT**  
**59-311**  
27 cm

30 mm



18 mm

**MURPHY-LANE**  
**59-312**  
Luksasyon elevatörü  
Luxation lever  
33 cm



1/2  
HOHMANN-ALDINGER  
59-313  
27 cm

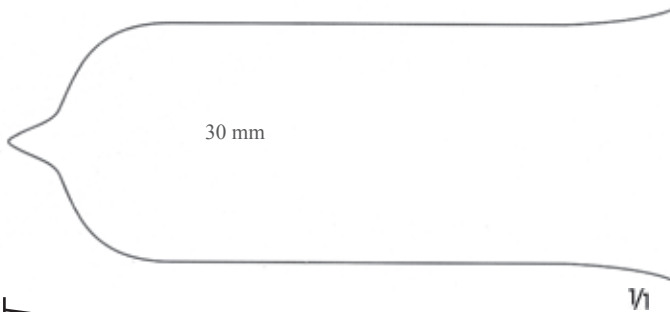


1/1



1/2  
59-314  
29 cm

1/1



TAYLOR  
**59-315** 30 x 70 mm  
 18.5 cm  
**59-316** 30 x 100 mm  
 20 cm



**59-317**  
 25 x 75 mm



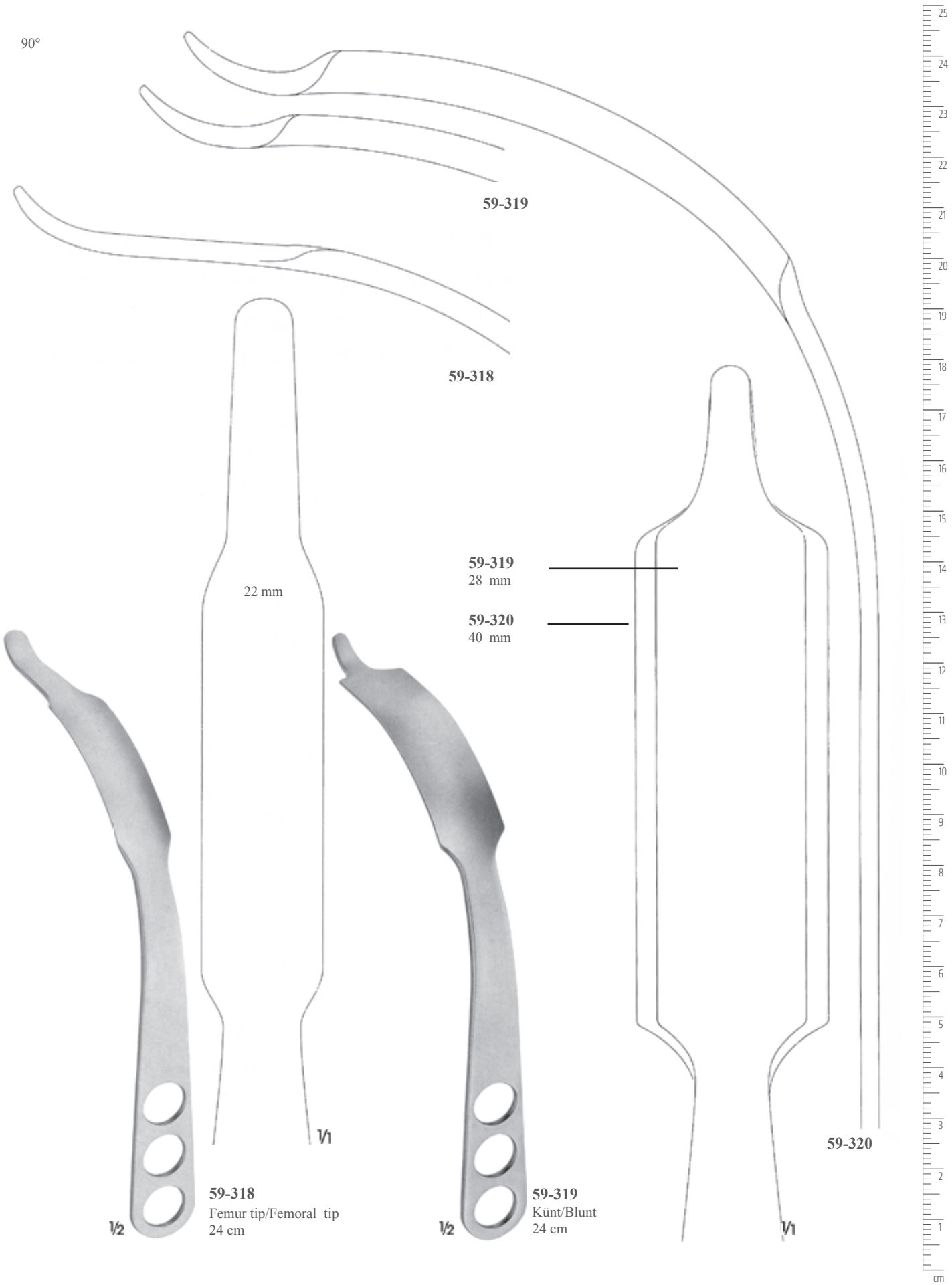
**59-316**  
 20 x 50 mm

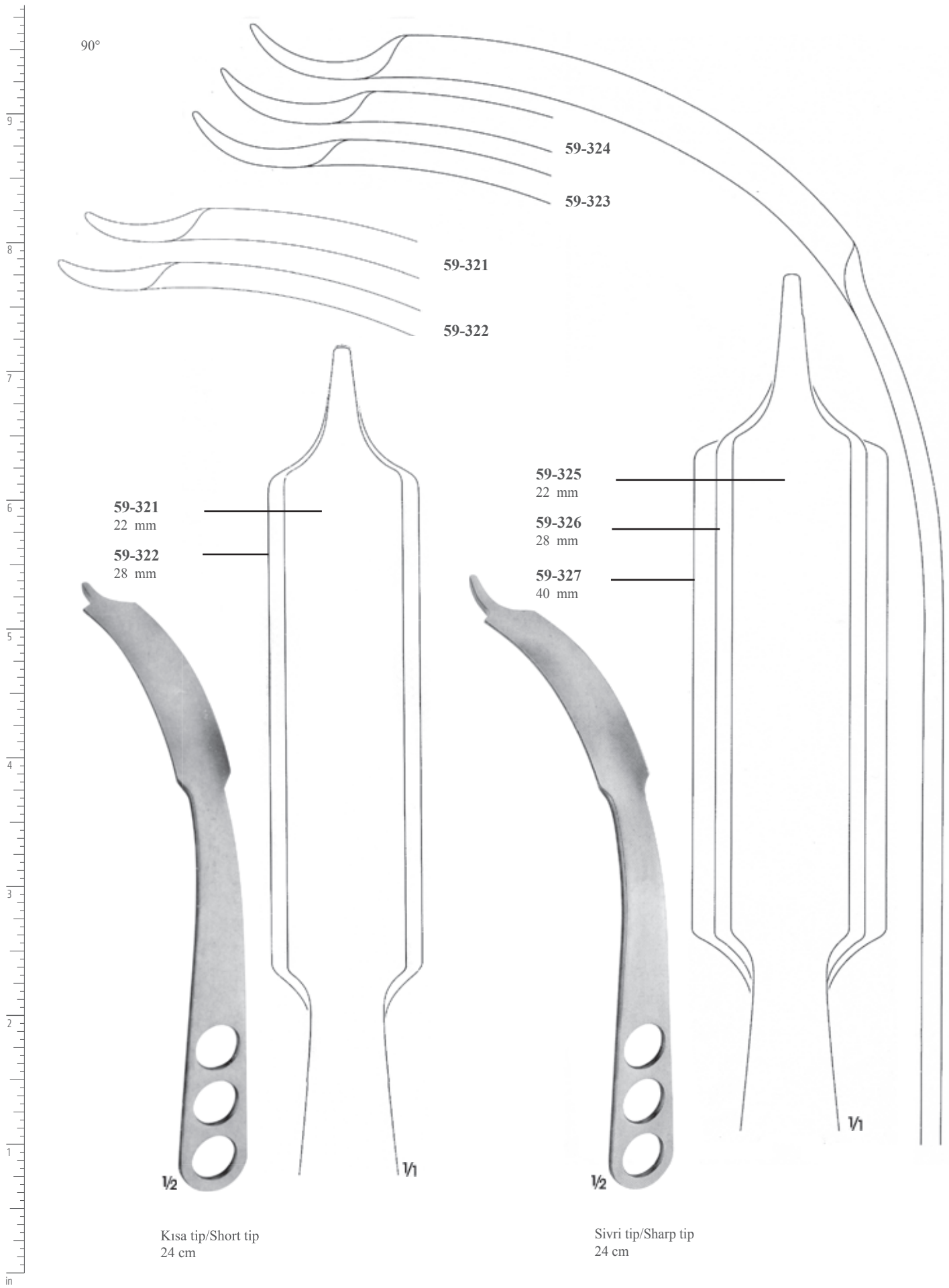


**59-315**  
 13 x 25 mm

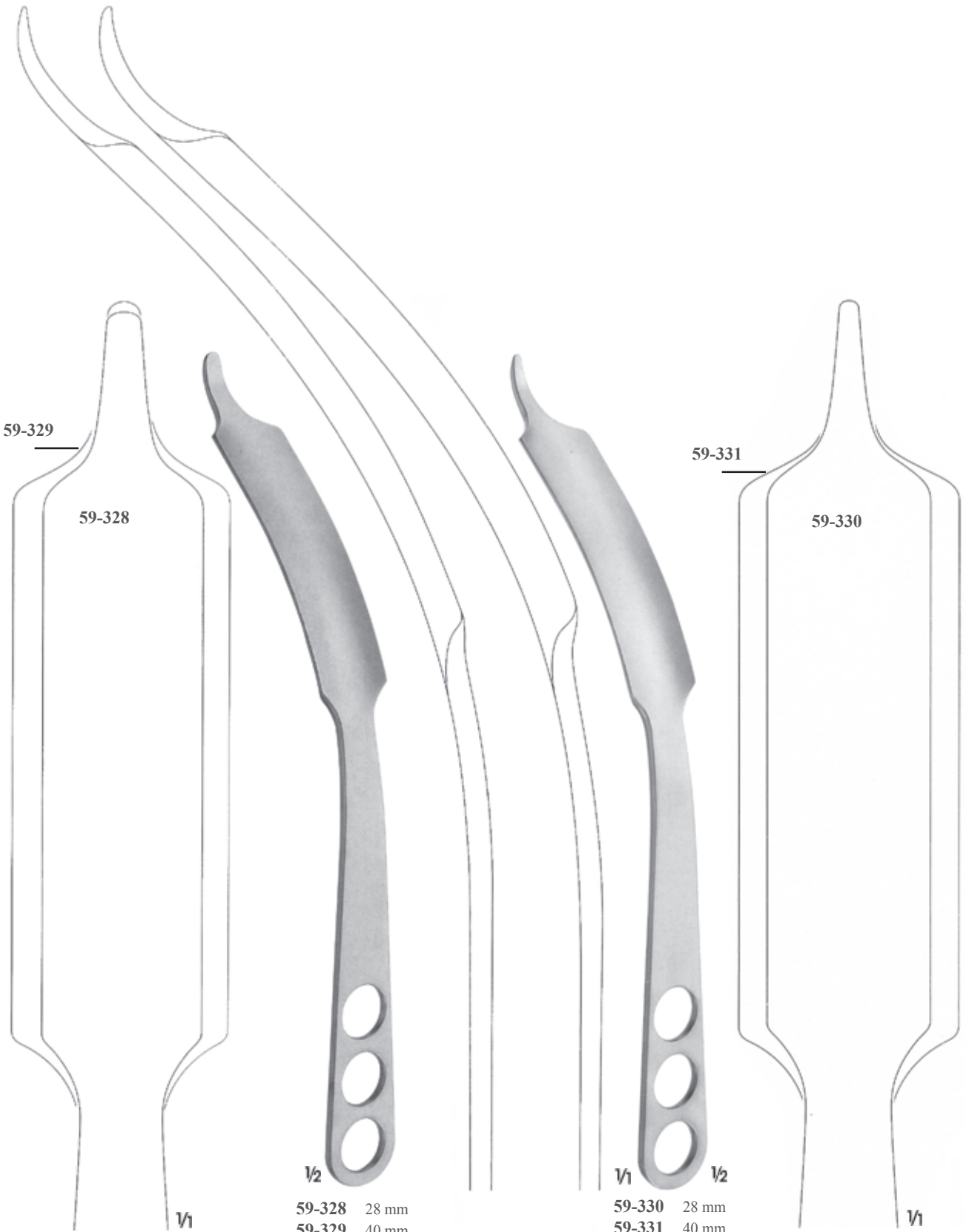
HIBBS  
 23.5 cm







45°



59-329

59-328

59-331

59-330

1/2

1/1

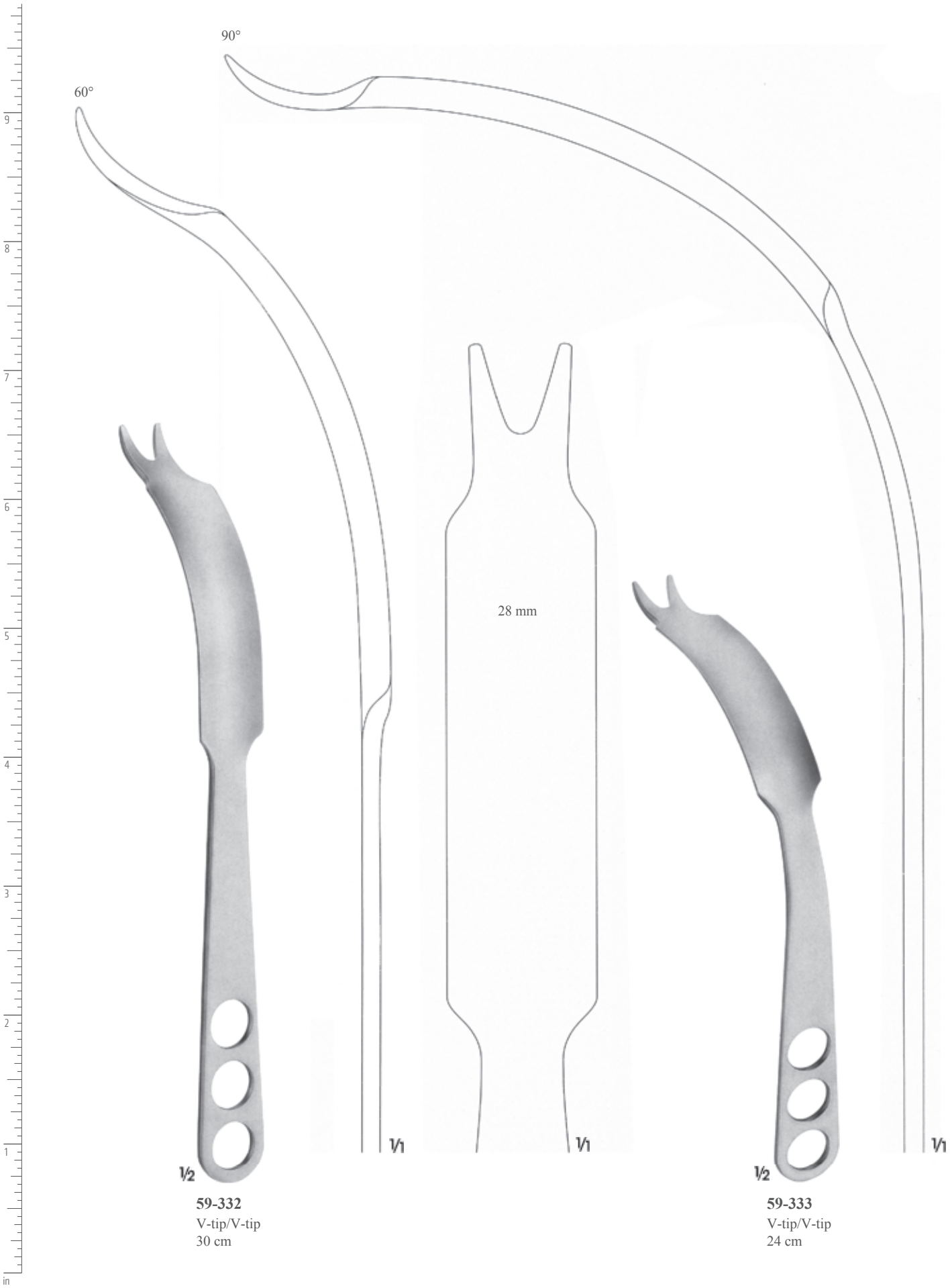
1/2

1/1

1/1

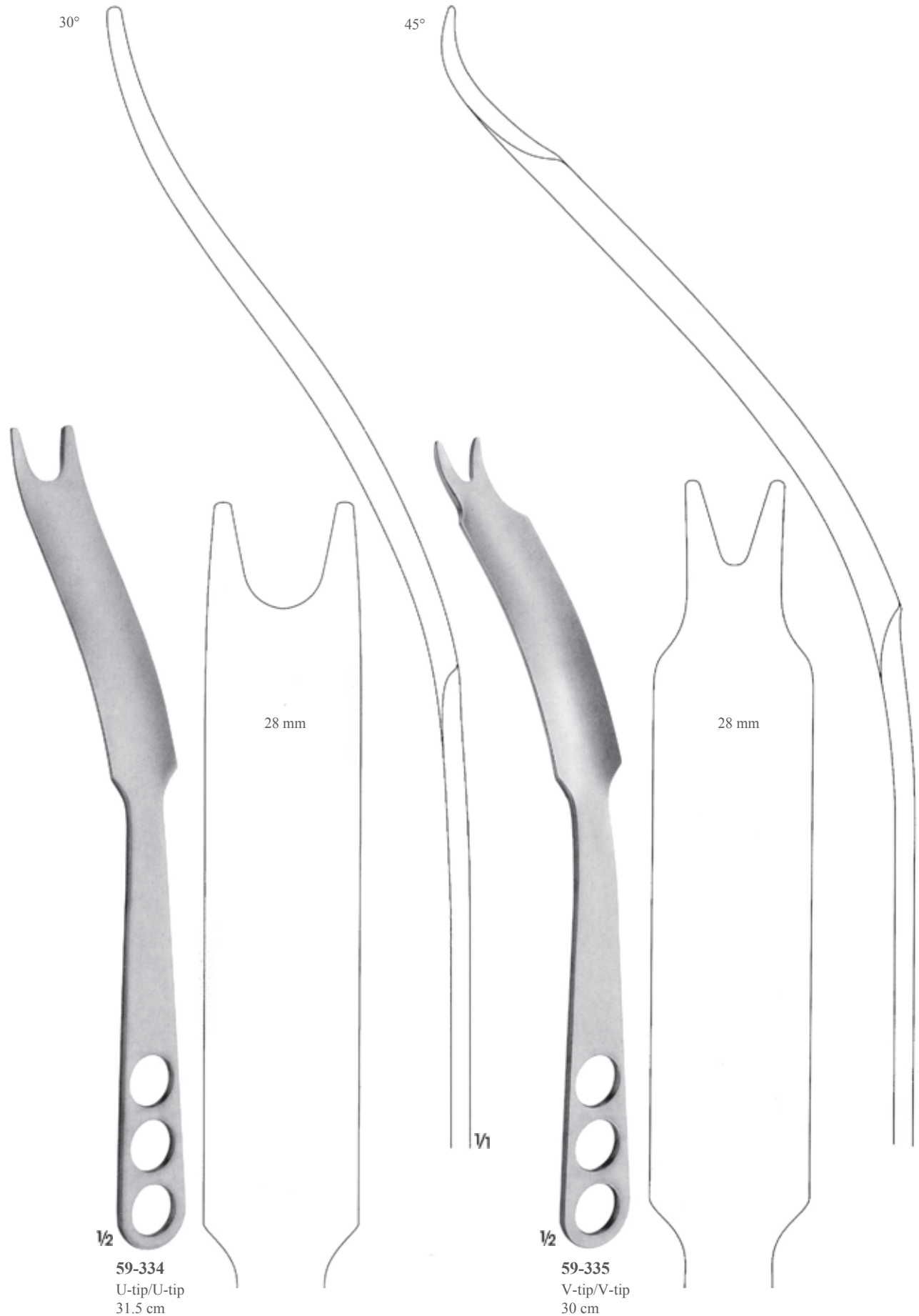
59-328 28 mm  
59-329 40 mm  
Künt/Blunt  
30 cm

59-330 28 mm  
59-331 40 mm  
Sivri/Sharp  
30 cm



$\frac{1}{2}$   
**59-332**  
V-tip/V-tip  
30 cm

$\frac{1}{2}$   
**59-333**  
V-tip/V-tip  
24 cm



30°

45°

28 mm

28 mm

1/2

**59-334**  
U-tip/U-tip  
31.5 cm

V1

1/2

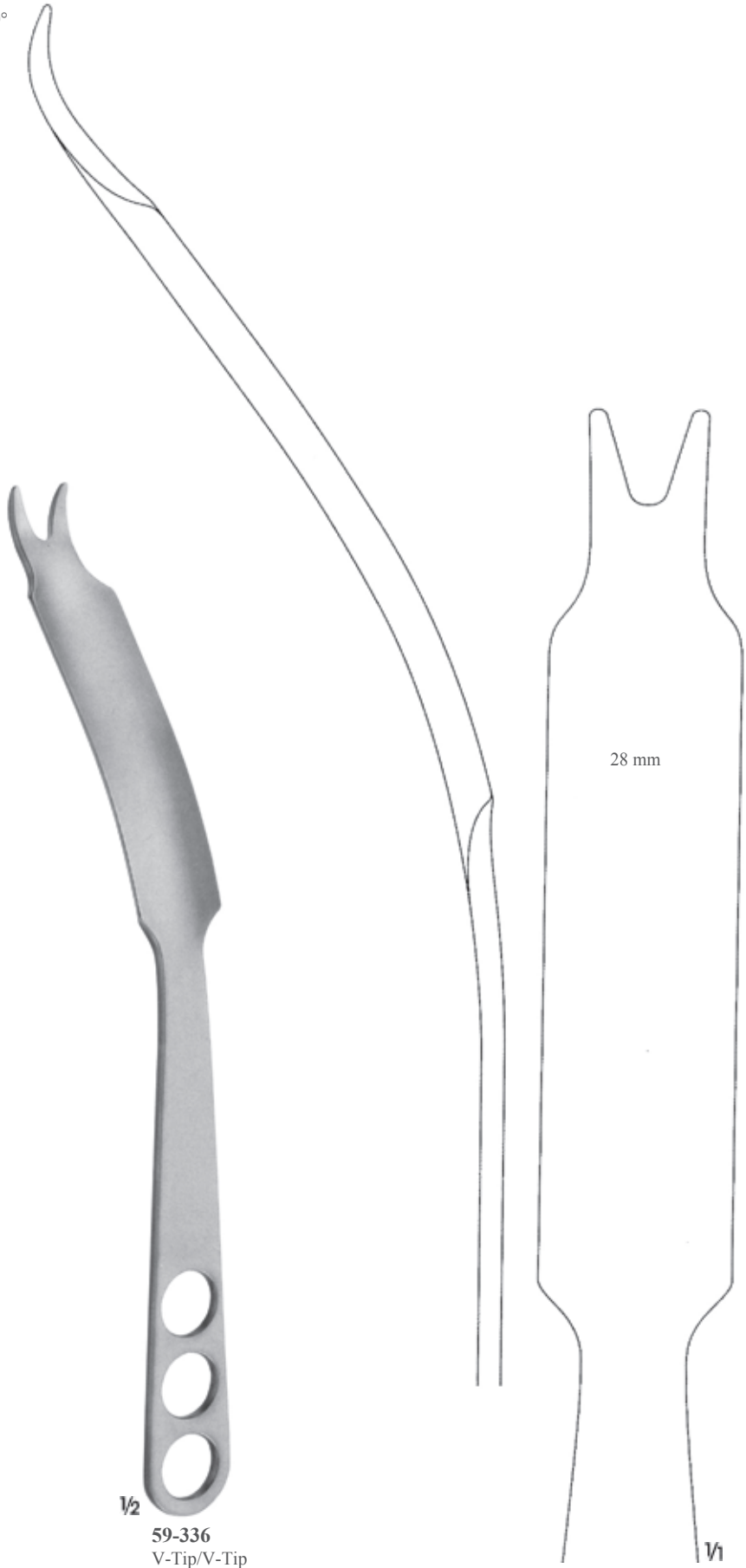
**59-335**  
V-tip/V-tip  
30 cm

V1



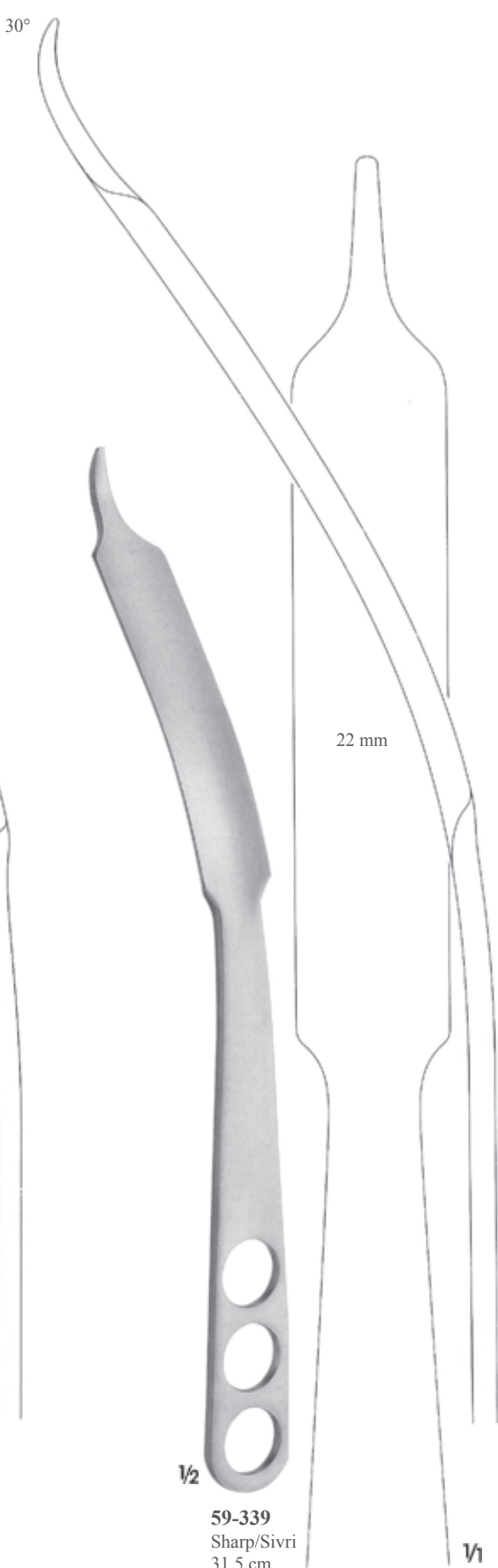
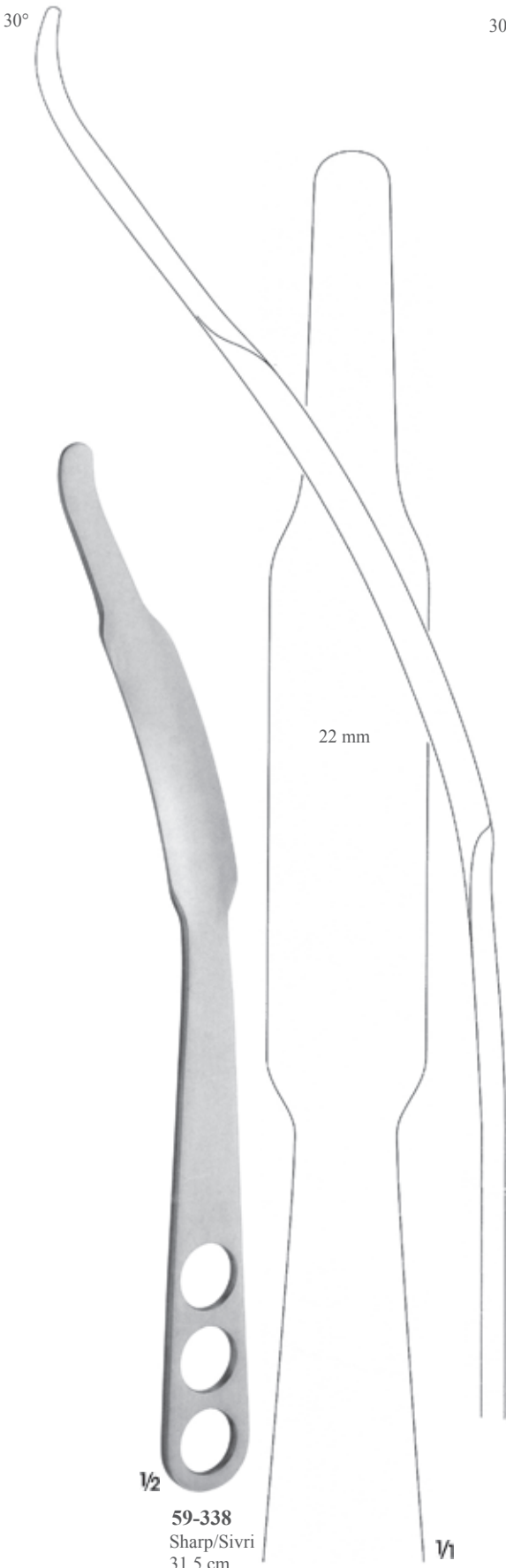


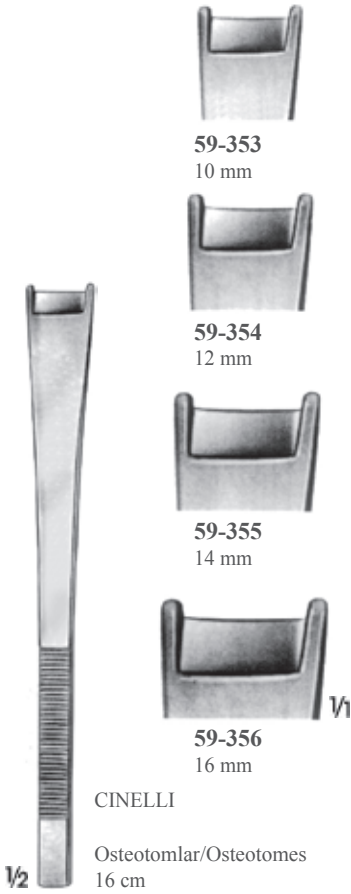
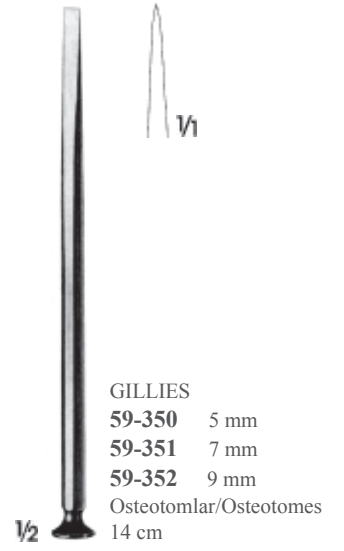
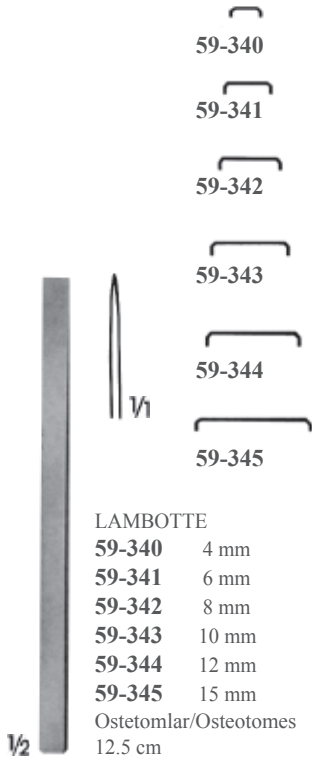
30°



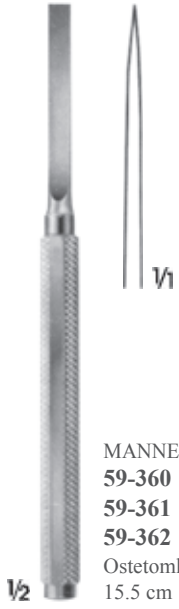
**1/2**  
**59-336**  
V-Tip/V-Tip  
31.5 cm

**1/1**









MANNERFELT  
**59-360** 4 mm  
**59-361** 6 mm  
**59-362** 8 mm  
 Osteotomlar/Osteotomes  
 15.5 cm



MANNERFELT  
**59-363** 3 mm  
 Guj/Gouges  
 15.5 cm



LUCAS  
**59-364** 3 mm  
**59-365** 5 mm  
 Gujlar/Gouges 16  
 cm



LUCAS  
**59-366** 4 mm  
**59-367** 6 mm  
 Çizıllar/Chisels  
 16 cm



KRAMER  
**59-368** 2.6 mm  
 Elçekli çizil  
 Shanks chisel  
 21.5 cm



EAST  
 GRINSTEAD(WARD)  
**59-369** 3 mm  
**59-370** 5 mm  
 Çizıllar/Chisels  
 18 cm



EASTMAN  
**59-371** 3 mm  
**59-372** 5 mm  
 Çizıllar/Chisels  
 19 cm



EAST GRINSTEAD  
**59-373** 3 mm  
**59-374** 5 mm  
 Osteotomlar/Osteotomes  
 18 cm





COTTLE  
**59-375** 4 mm  
**59-376** 6 mm  
**59-377** 8 mm  
**59-378** 10 mm  
**59-379** 12 mm  
 Derinlik göstergeli osteotomlar  
 Osteotomes with depth  
 markings  
 18 cm



V1



COTTLE  
**59-380** 4 mm  
**59-381** 7 mm  
**59-382** 9 mm  
**59-383** 12 mm  
 Derinlik göstergeli  
 Çizıl-osteotomlar  
 Chisel-osteotomes  
 with depth markings  
 18 cm



V1



COTTLE  
**59-384** 6mm  
 Çizıl-osteotom  
 Chisel-osteotomes  
 18 cm



V1



COTTLE  
**59-385** 8 mm  
 Derinlik göstergeli çizıl  
 Chisel with depth  
 markings  
 18 cm



V1



PARTSCH  
**59-386** 3 mm  
**59-387** 4 mm  
**59-388** 5 mm  
**59-389** 6 mm  
 Gujlar/Gouges  
 14 cm



V1



**59-390** 4 mm  
**59-391** 6 mm  
**59-392** 8 mm  
**59-393** 10 mm  
**59-394** 12 mm  
 Gujlar/Gouges 14  
 cm



V1



PARTSCH  
**59-395** 3 mm  
**59-396** 4 mm  
**59-397** 5 mm  
**59-398** 6 mm  
**59-399** 7 mm  
 Gujlar/Gouges  
 17 cm



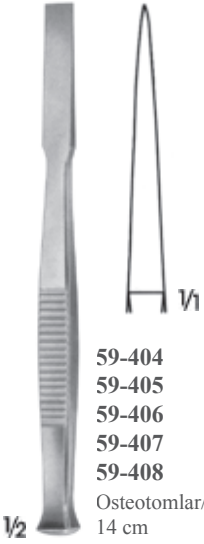
V1



ALEXANDER  
**59-400** 5 mm  
**59-401** 7 mm  
**59-402** 9 mm  
**59-403** 11 mm  
 Gujlar/Gouges 17  
 cm



V1



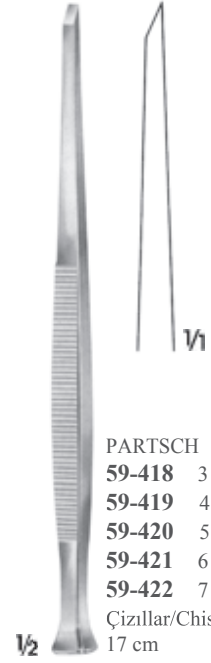
**59-404** 4 mm  
**59-405** 6 mm  
**59-406** 8 mm  
**59-407** 10 mm  
**59-408** 12 mm  
Osteotomlar/Osteotomes  
14 cm



**59-409** 4 mm  
**59-410** 6 mm  
**59-411** 8 mm  
**59-412** 10 mm  
**59-413** 12 mm  
Çizıllar/Chisels  
14 cm



**PARTSCH**  
**59-414** 3 mm  
**59-415** 4 mm  
**59-416** 5 mm  
**59-417** 6 mm  
Çizıllar/Chisels  
14 cm



**PARTSCH**  
**59-418** 3 mm  
**59-419** 4 mm  
**59-420** 5 mm  
**59-421** 6 mm  
**59-422** 7 mm  
Çizıllar/Chisels  
17 cm



**59-423**  
Guj,düz  
Gouge straight  
11 cm



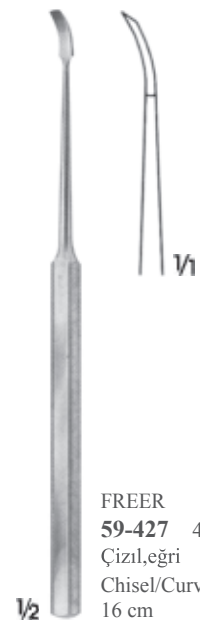
**59-424**  
Guj, kaşık şeklinde eğri  
Gouge spoon-shaped  
curved  
11 cm



**FREER**  
**59-425** 6 mm  
Guj/Gouge  
15 cm



**FREER**  
**59-426** 4 mm  
Çizıl/Chisel  
16 cm



**FREER**  
**59-427** 4 mm  
Çizıl,eğri  
Chisel/Curved  
16 cm





LAMBOTTE

- 59-428 4 mm
  - 59-429 8 mm
  - 59-430 10 mm
  - 59-431 13 mm
  - 59-432 15 mm
  - 59-433 18 mm
  - 59-434 20 mm
  - 59-435 25 mm
  - 59-436 30 mm
  - 59-437 38 mm
  - 59-438 44 mm
  - 59-439 50 mm
- Osteotomlar/Osteotomes  
24.5 cm



1/1



LAMBOTTE

- 59-440 8 mm
  - 59-441 13 mm
  - 59-442 18 mm
  - 59-443 25 mm
  - 59-444 30 mm
  - 59-445 38 mm
- Osteotomlar/Osteotomes  
Eğri/Curved  
24.5 cm



1/1



NIEDERDELMANN

- 59-446 8 mm
  - 59-447 10 mm
- Osteotomlar/Osteotomes  
Eğri/Curved  
25 cm



1/1



OBWEGESER

- 59-448 11 mm
- Osteotom/Osteotome  
Eğri/Curved  
23.5 cm



1/1

143° buhar sterilizatörlerinde steril edilebilir.  
Can be sterilized in a steam sterilizer up to 143 °

143° buhar sterilizatörlerinde steril edilebilir.  
Can be sterilized in a steam sterilizer up to 143°



**59-449** 10 mm  
**59-450** 15 mm  
**59-451** 20 mm  
Çizıl/Chisels  
20 cm



**59-452** 10 mm  
**59-453** 15 mm  
**59-454** 20 mm  
Çizıl, eğri/Chisels, curved  
20 cm



LEXER-MINI  
**59-455** 4 mm  
**59-456** 6 mm  
**59-457** 8 mm  
**59-458** 10 mm  
**59-459** 12 mm  
Osteotomlar/Osteotomes  
18 cm



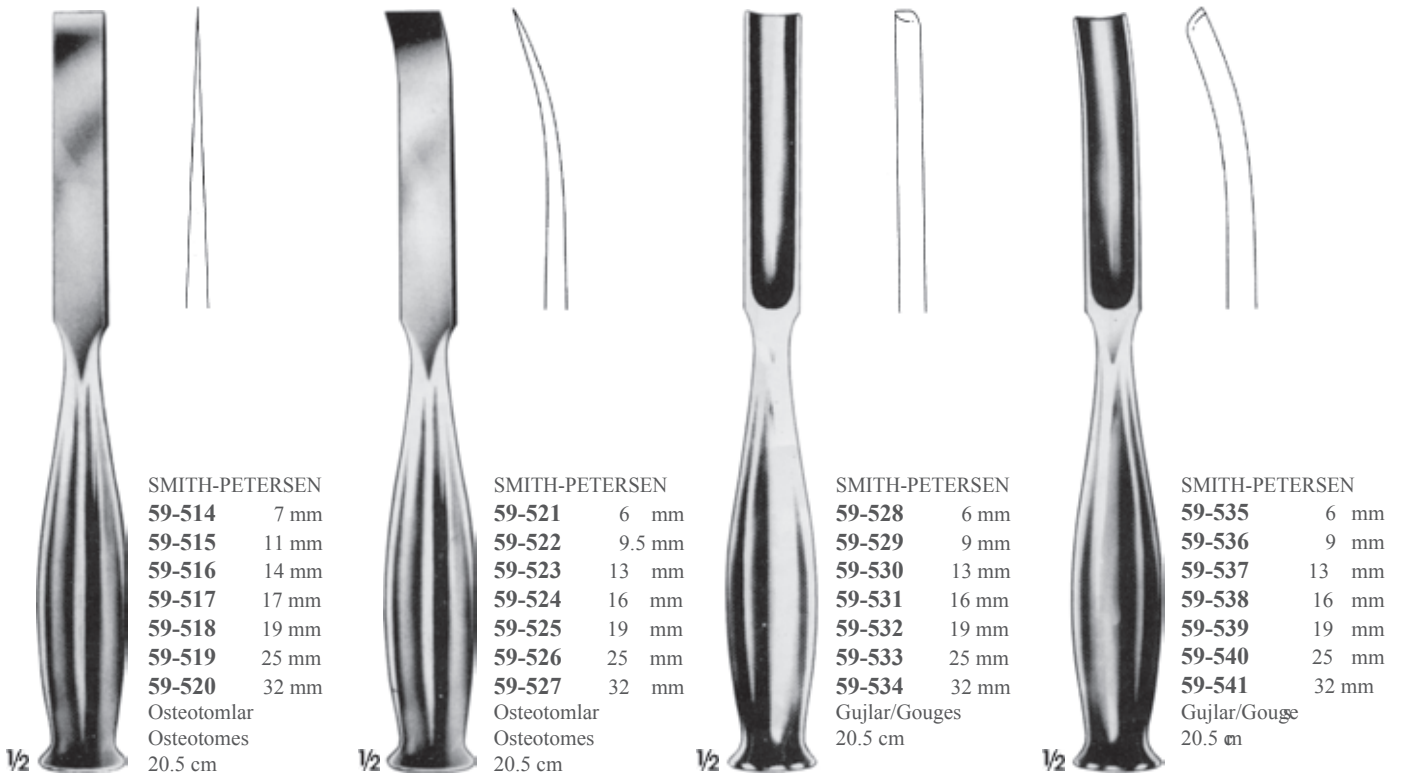
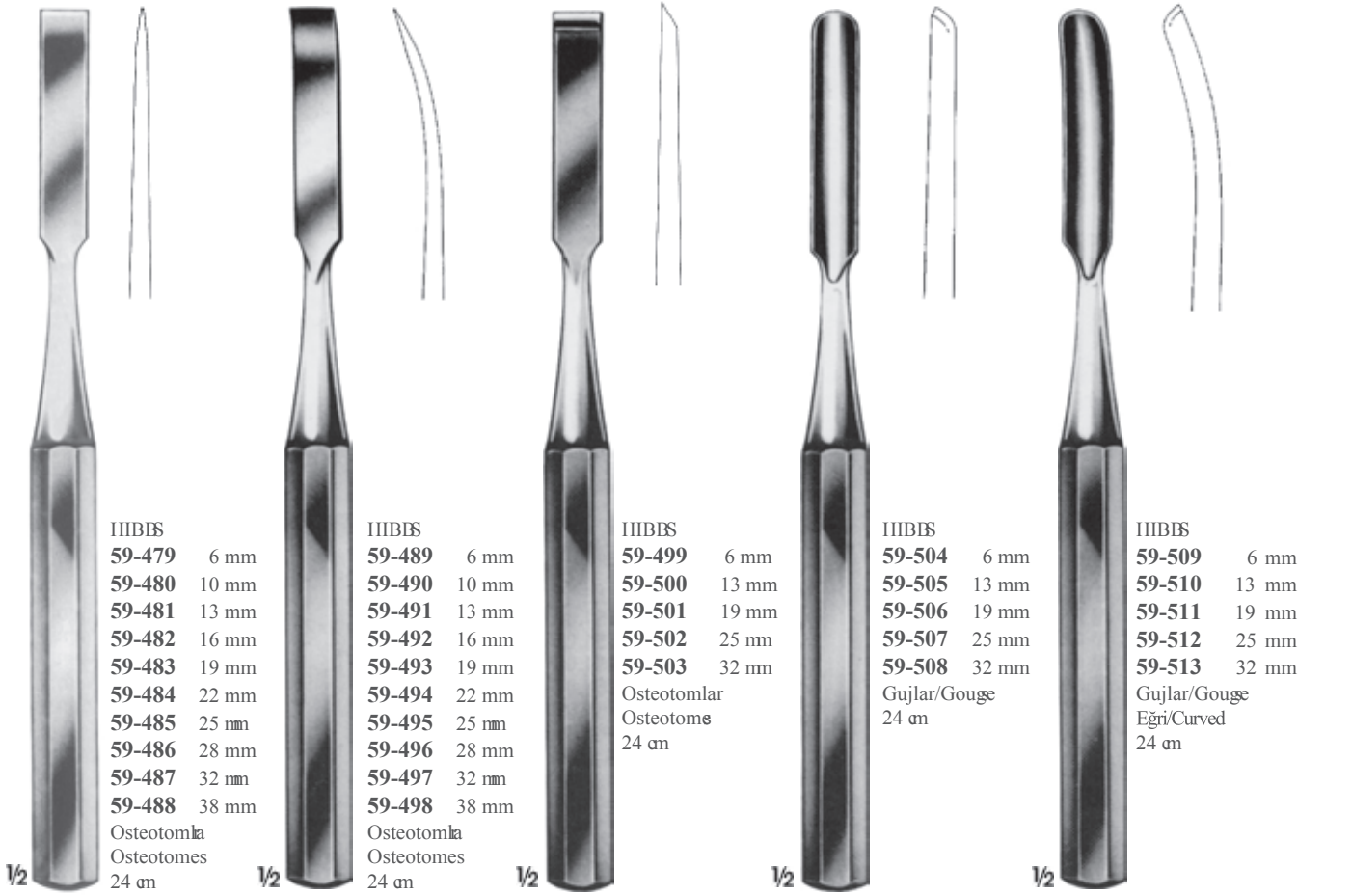
LEXER-MINI  
**59-460** 4 mm  
**59-461** 6 mm  
**59-462** 8 mm  
**59-463** 10 mm  
**59-464** 12 mm  
Gujlar/Gouges  
18 cm



LEXER  
**59-465** 5 mm  
**59-466** 7 mm  
**59-467** 10 mm  
**59-468** 15 mm  
**59-469** 20 mm  
**59-470** 25 mm  
**59-471** 30 mm  
Osteotomlar/Osteotomes  
22 cm



LEXER  
**59-472** 5 mm  
**59-473** 7 mm  
**59-474** 10 mm  
**59-475** 15 mm  
**59-476** 20 mm  
**59-477** 25 mm  
**59-478** 30 mm  
Gujlar/Gouges  
22 cm





STILLE  
**59-542** 10 mm  
**59-543** 12 mm  
**59-544** 15 mm  
**59-545** 20 mm  
**59-546** 25 mm  
 Osteotomlar/Osteotomes  
 20.5 cm

1/2



STILLE  
**59-547** 8 mm  
**59-548** 10 mm  
**59-549** 12 mm  
**59-550** 15 mm  
**59-551** 20 mm  
**59-552** 25 mm  
 Osteotomlar/Osteotomes  
 20.5 cm

1/2



STILLE  
**59-553** 10 mm  
**59-554** 12 mm  
**59-555** 15 mm  
**59-556** 20 mm  
**59-557** 25 mm  
 Çizallar/Chisels  
 20.5 cm

1/2



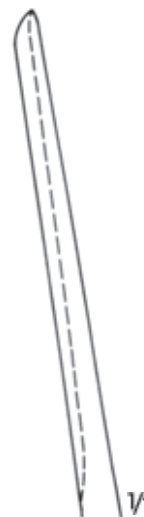
STILLE  
**59-558** 10 mm  
**59-559** 12 mm  
**59-560** 15 mm  
**59-561** 20 mm  
**59-562** 25 mm  
 Osteotomlar/Osteotomes  
 Eğri/Curved  
 20.5 cm

1/2



STILLE  
**59-563** 10 mm  
**59-564** 12 mm  
**59-565** 15 mm  
**59-566** 20 mm  
**59-567** 25 mm  
 Gujlar/Gouges  
 20.5 cm

1/2



WALTER  
**59-568** 10 mm  
**59-569** 15 mm  
 Gref alıcı gujlar  
 Gouges grafts recipient  
 20.5 cm

1/2

143 ° buhar sterilizatörlerinde steril edilebilir.  
Can be sterilized in a steam sterilizer up to 143°



**1/2**  
**59-570** 20 mm  
Çizıl/Chisels  
24.5 cm



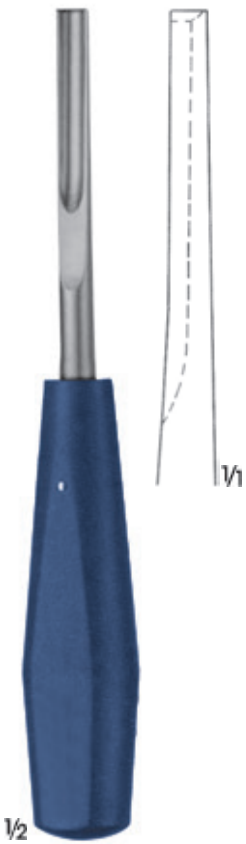
**1/2**  
**59-571** 16 mm  
Çizıl, eğri  
Chisel, curved  
26.5 cm



**1/2**  
**LEXER**  
**59-572** 10 mm  
**59-573** 15 mm  
Osteotomlar, açılı  
Osteotomes angled  
27.5 cm



143 ° buhar sterilizatörlerinde steril edilebilir.  
Can be sterilized in a steam sterilizer up to 143°



**59-574** 9 mm  
Kırık vida çıkartıcı guj  
Broken screw extractor  
gouges  
22 cm



ZIELKE  
**59-575** 5.5 mm  
**59-576** 9.0 mm  
Skolyoz operasyonu için gujlar  
Gouges for scoliosis operations  
25 cm



**59-577** 5 mm  
**59-578** 10 mm  
**59-579** 15 mm  
Sponjiyoz gujlar, eğri  
Spongiosa gouges, curved  
25 cm



LEXER  
**59-580**  
Sponjiyoz guj  
Spongiosa gouges  
28 cm





59-581 6 mm  
59-582 8 mm  
59-583 11 mm  
59-584 16 mm  
Tabaka gujlar, çevrimli  
Lamina gouge, cranked  
23.5 cm



59-585  
27 cm



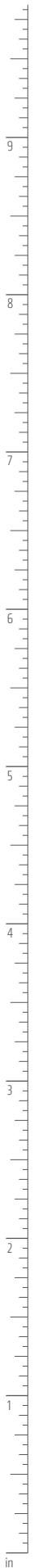
59-586  
27 cm



59-587  
25 cm

143° buhar sterilizatörlerinde steril edilebilir.  
Can be sterilized in a steam sterilizer up to 143°





8 mm



1/2

COBB  
59-595  
28 cm

8 mm



1/2

COBB  
59-596  
28 cm

8 mm



1/2

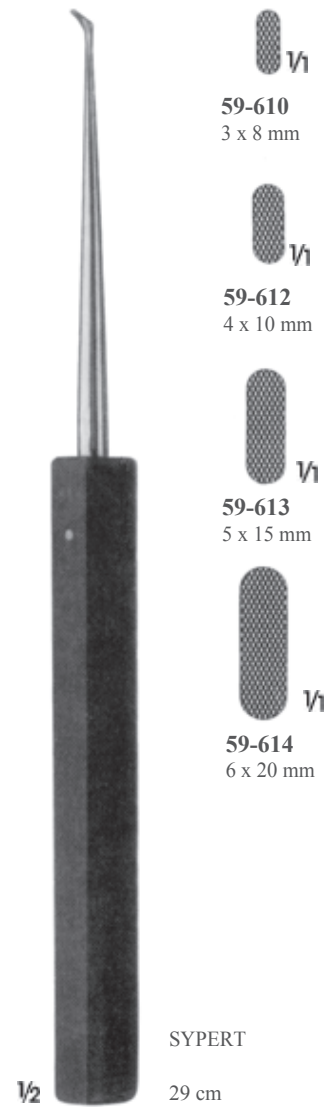
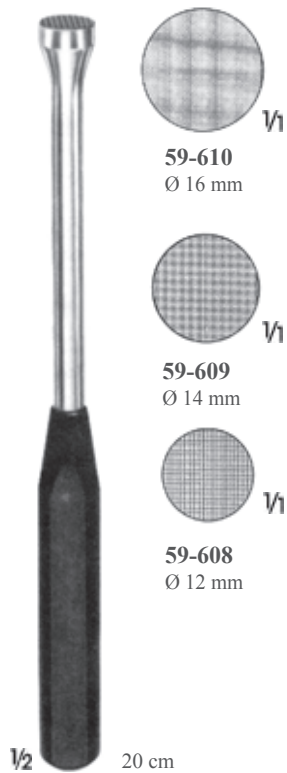
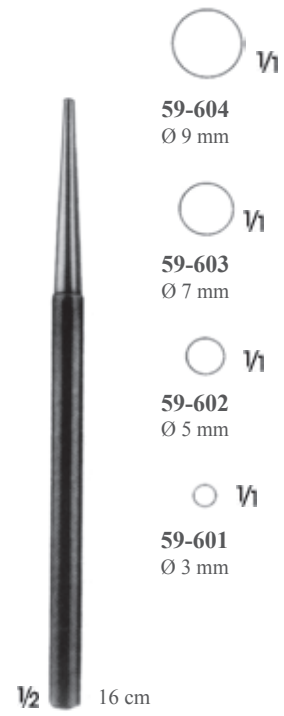
COBB  
59-597  
28 cm

8 mm



1/2

COBB  
59-598  
28 cm



Çekiçin başlıklarına göre ağırlıkları değişebilir  
Weights refer to heads of the mallets



Ø 22 mm

**59-615**  
80 gr  
16.5 cm

1/2



Ø 25 mm

**59-616** 130 gr.  
Bir yüzeyi pürüzlü, Bir yüzeyi pürüzsüz With one smooth and one rough surface  
18.5 cm

1/2



Ø 23 mm

**FICKLING**  
**59-617** 190 gr  
19 cm

1/2



**CLOWARD**  
**59-618** 230 gr.  
19 cm

**59-619** 370 gr.  
23 cm

1/2



Ø 22 mm

**59-620**  
155 gr  
19 cm

1/2

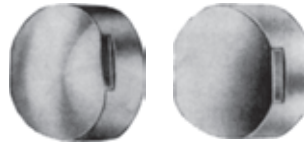
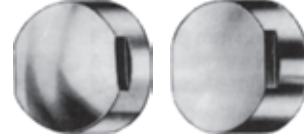


Ø 27 mm

**HAJEK**  
**59-621**  
135 gr.  
22 cm

1/2

Çekiğin başlıklarına göre ağırlıkları değişebilir  
Weights refer to heads of the mallets



Çekiğin başlıklarına göre ağırlıkları değişebilir  
Weights refer to heads of the mallets



Ø 45 mm

1/2

BERGMANN  
59-633 300 gr  
24.5 cm



Ø 30 mm

Ø 42 mm

1/2

59-634 285 gr  
24 cm



143 ° buhar sterilizatörlerinde steril edilebilir.  
Can be sterilized in a steam sterilizer up to 143 °

1/2

59-635 Ø 35 mm  
59-636 Ø 42 mm  
59-637 Ø 50 mm  
25 cm



□ 27 mm

Ø 13.5 mm

1/2

59-638 425 gr  
Implantlara uygun  
ortopedik çekiç Head  
made of material used  
for implants 23.5 cm



Çekicinin başlıklarına göre ağırlıkları değişebilir  
Weights refer to heads of the mallets



HEATH  
59-639 660 gr  
Ø 40 mm 18.5 cm  
59-640 725 gr  
Ø 45 mm 20 cm  
Ağır ekiç  
Triphammer



Ø 30 mm  
COTTLE  
59-641 235 gr  
Bir tarafı düz, bir tarafı bombeli  
Bir side flet, bir side convex  
18.5cm



Ø 40 mm  
OMBREDANNE  
59-642 520 gr  
24 cm



Ø 30 mm  
BERGMANN  
59-643 245 gr  
23.5 cm





**60**



0.5

1/2

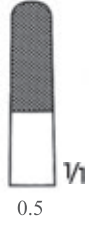
**60-100**  
Tel bükücü/Wire twister  
Bağlama pens/Ligature forceps  
15 cm



0.5

1/2

**60-101**  
Tel bükücü/Wire twister  
Bağlama pens/Ligature forceps  
15 cm



0.5

1/2

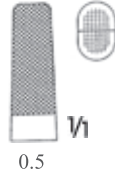
**60-102**  
Sternum dikişi için  
For sternum suture  
17.5 cm



0.5

1/2

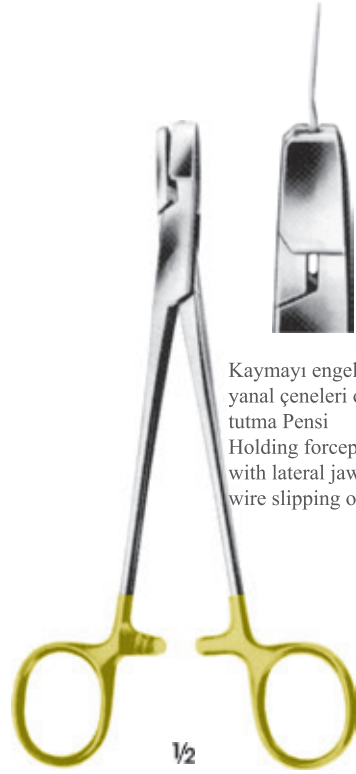
**BERRY**  
**60-103**  
Tel bükücü/Wire twister  
Bağlama pens/Ligature forceps  
18.5 cm



0.5

1/2

**BAUMGARTNER**  
**60-104**  
Tel bükücü/Wire twister  
Bağlama pens/Ligature forceps  
20 cm



1/2

Kaymayı engellemek için  
yanal çeneleri olan serklaj teli  
tutma Pensi  
Holding forceps for cerclage wire,  
with lateral jaws to avoid  
wire slipping off

1/2

**60-105**  
17 cm





**60-106**  
Alçı ayırıcı  
Plaster shear  
23 cm



**HENNIG**  
**60-107**  
Alçı ayırıcı  
Plaster shear  
27 cm



**WOLFF**  
**60-108** 18 cm  
**60-109** 24 cm  
Alçı kesiciler  
Plaster breakers

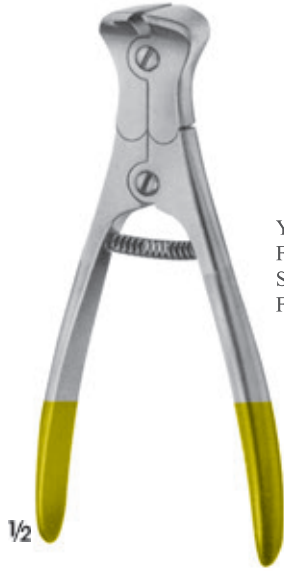


**60-110**  
Alçı ayırıcı  
Plaster shear  
29 cm



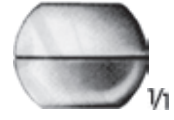
Sökülebilir çeneli  
With removable jaws





Yumuşak tel için Ø 2.0 mm  
For soft wire Ø 2.0 mm  
Sert tel için Ø 1.5 mm  
For hard wire Ø 1.5 mm

60-111  
14.5 cm



Yumuşak tel için Ø 1.5 mm  
For soft wire Ø 1.5 mm  
Sert tel için Ø 1.0 mm  
For hard wire Ø 1.0 mm

60-112  
14.5 cm



Yumuşak tel için Ø 3.5 mm  
For soft wire Ø 3.5 mm  
Sert tel için Ø 2.5 mm  
For hard wire Ø 2.5 mm

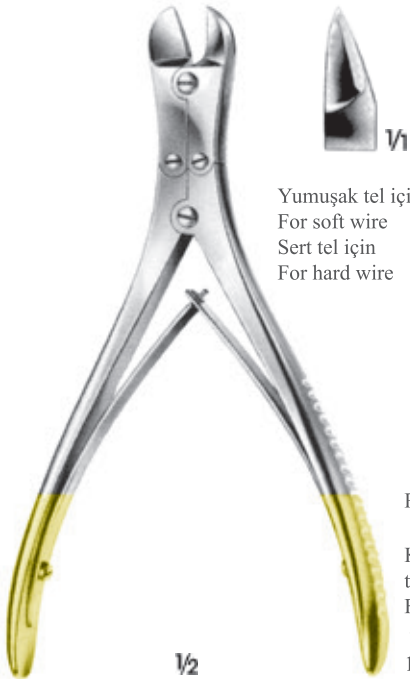
60-113  
16.5 cm



Yumuşak tel için Ø 3.0 mm  
For soft wire Ø 3.0 mm  
Sert tel için Ø 2.0 mm  
For hard wire Ø 2.0 mm

60-114  
22 cm

Özel sertleştirilmiş kesici ağız  
Specially hardened cutting edges



Özel sertleştirilmiş kesici ağız  
Specially hardened cutting edges



Sert metal kesici ağız  
Tungsten carbide cutting edges





**60-119**  
16 cm

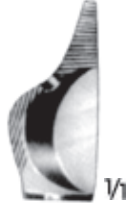


V1

Yumuşak tel için Ø 1.5 mm  
For soft wire Ø 1.5 mm  
Sert tel için Ø 1.2 mm  
For hard wire Ø 1.2 mm

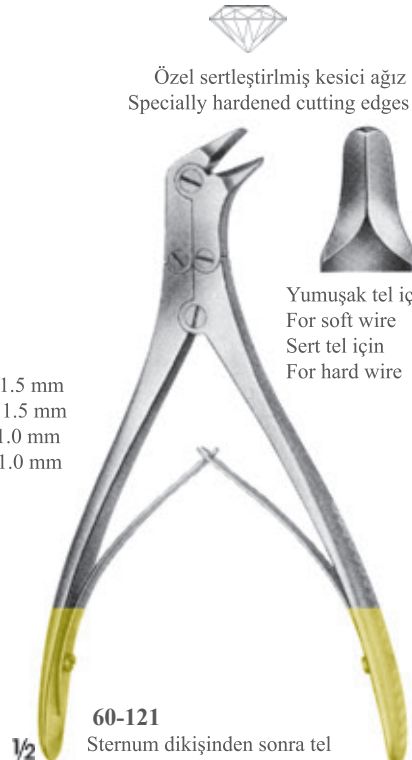


**60-120**  
15 cm



V1

Yumuşak tel için Ø 1.5 mm  
For soft wire Ø 1.5 mm  
Sert tel için Ø 1.0 mm  
For hard wire Ø 1.0 mm



**60-121**

Sternum dikişinden sonra tel çıkartılması için açılı narin yapı  
Angled slender pattern for wire removal after sternum suture  
17 cm

Özel sertleştirilmiş kesici ağız  
Specially hardened cutting edges



V1

Yumuşak tel için Ø 0.9 mm  
For soft wire Ø 0.9 mm  
Sert tel için -  
For hard wire -



Özel sertleştirilmiş kesici ağız  
Specially hardened cutting edges



**HARVEY**  
**60-122**  
Tel kesme pens  
Wire cutting pliers  
23 cm



V1

Yumuşak tel için Ø 3.0 mm  
For soft wire Ø 3.0 mm  
Sert tel için Ø 2.2 mm  
For hard wire Ø 2.2 mm



**60-123**  
Yanal kesme  
Lateral cutting  
23.5 cm



V1

Yumuşak tel için Ø 3.0 mm  
For soft wire Ø 3.0 mm  
Sert tel için Ø 2.2 mm  
For hard wire Ø 2.2 mm





**60-124**

Ø 6 mm kadar tel, vida, çivi vs. kesmek için  
For cutting off wires, screws, pins, etc. up to Ø 6 mm  
47 cm



**60-125**

Ø 3 mm kadar tel, vida, çivi vs. kesmek için  
For cutting off wires, screws, pins, etc. up to Ø 3 mm  
32 cm





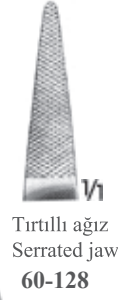
**MARBURG MODELL**  
**60-126**  
Tel tutma pensi,  
Düz burunlu, tırtıllı ağız  
Wire holding forceps,  
Flat nosed, with serrated jaws  
14 cm



**GOSLEE**  
Tel bükücü, düz burunlu  
Wire twister, flat nosed  
14 cm



Düz ağız  
Smooth jaw  
**60-127**



Tırtıllı ağız  
Serrated jaw  
**60-128**



Tel bükücü, düz burunlu  
Wire twister, flat nosed  
17 cm



**60-129**  
Tırtıllı ağız  
With serrated jaws



Boylamasına ve  
çapraz kanallı  
With longitudinal  
and transversal  
grooves  
**60-130**



**60-131**  
19.5 cm



**60-132**  
Tel tutma pensi, düz burunlu  
Wire holding forceps, flat nosed  
19 cm



**1/1**



**60-133**  
13 cm



**60-134**  
18 cm

**1/1**



**60-135**  
Yuvarlak pens  
Round pliers  
18 cm



**60-137**  
Tel çıkartıcı pens  
Extraction pliers  
for wires  
18 cm



**60-136**  
Tel çıkartıcı pens  
Extraction pliers for  
wires  
14.5 cm



**60-138**  
Tel çıkartıcı pens  
Extraction pliers for  
wires  
18 cm



**60-139**  
Ø 1.8 mm kadar teller için  
bükme pens  
Bending pliers for wires up to  
1.8 mm diam.



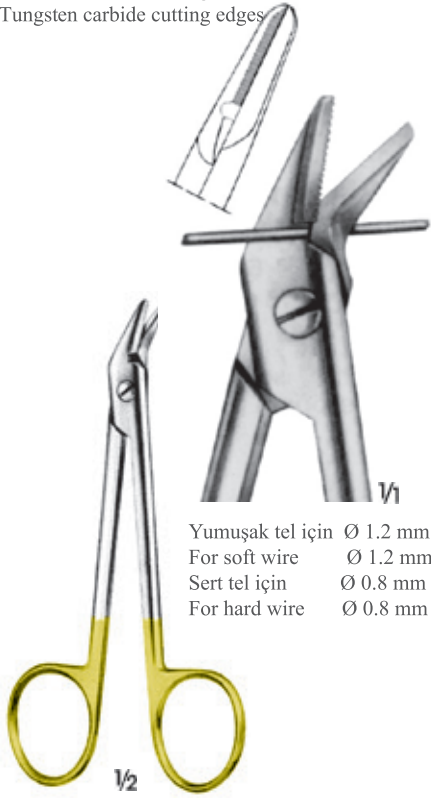
**60-140**  
Paralel düz tutucu  
Flat-nosed pliers, parallel  
18.5 cm



**60-141**  
Mengene kavramalı, ayarlı pense  
Vise grip pliers set  
20 cm

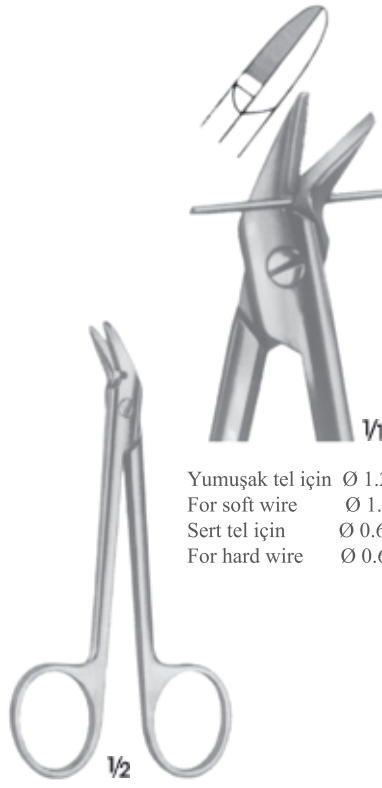


Sert metal kesici ağız  
Tungsten carbide cutting edges



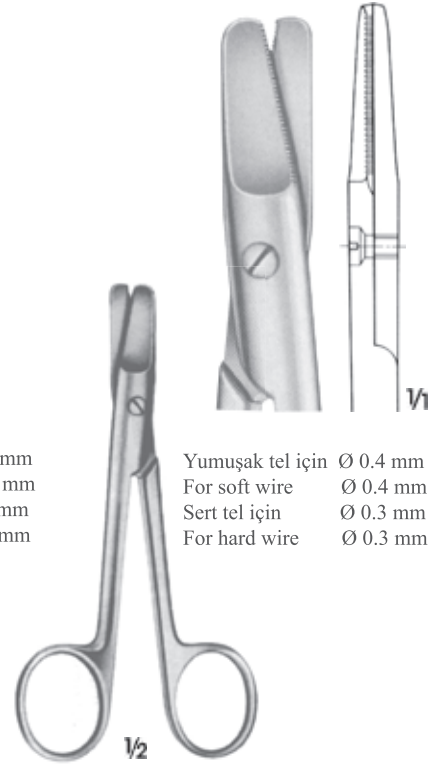
Yumuşak tel için Ø 1.2 mm  
For soft wire Ø 1.2 mm  
Sert tel için Ø 0.8 mm  
For hard wire Ø 0.8 mm

**60-142**  
Tek ağız tırtıllı  
One jaw serrated  
12 cm



Yumuşak tel için Ø 1.2 mm  
For soft wire Ø 1.2 mm  
Sert tel için Ø 0.6 mm  
For hard wire Ø 0.6 mm

**60-143**  
Tek ağız tırtıllı  
One jaw serrated  
12 cm

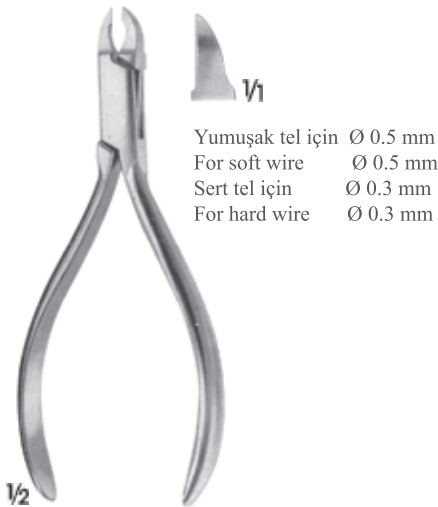


Yumuşak tel için Ø 0.4 mm  
For soft wire Ø 0.4 mm  
Sert tel için Ø 0.3 mm  
For hard wire Ø 0.3 mm

**HARVEY**  
**60-144**  
Çift ağız tırtıllı  
Both jaws serrated  
12.5 cm



Özel sertleştirilmiş kesici ağız  
Specially hardened cutting edges



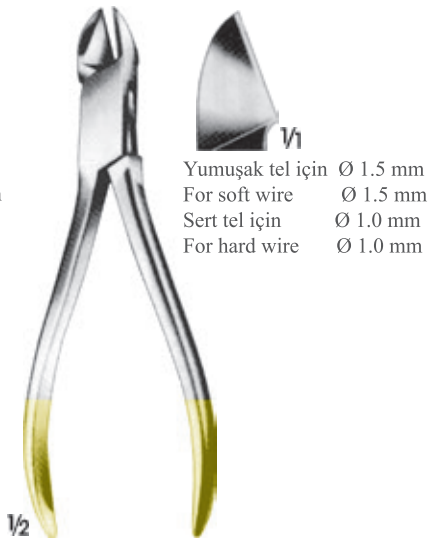
Yumuşak tel için Ø 0.5 mm  
For soft wire Ø 0.5 mm  
Sert tel için Ø 0.3 mm  
For hard wire Ø 0.3 mm

**ANGLE**  
**60-145**  
13 cm



Yumuşak tel için Ø 0.6 mm  
For soft wire Ø 0.6 mm  
Sert tel için Ø 0.4 mm  
For hard wire Ø 0.4 mm

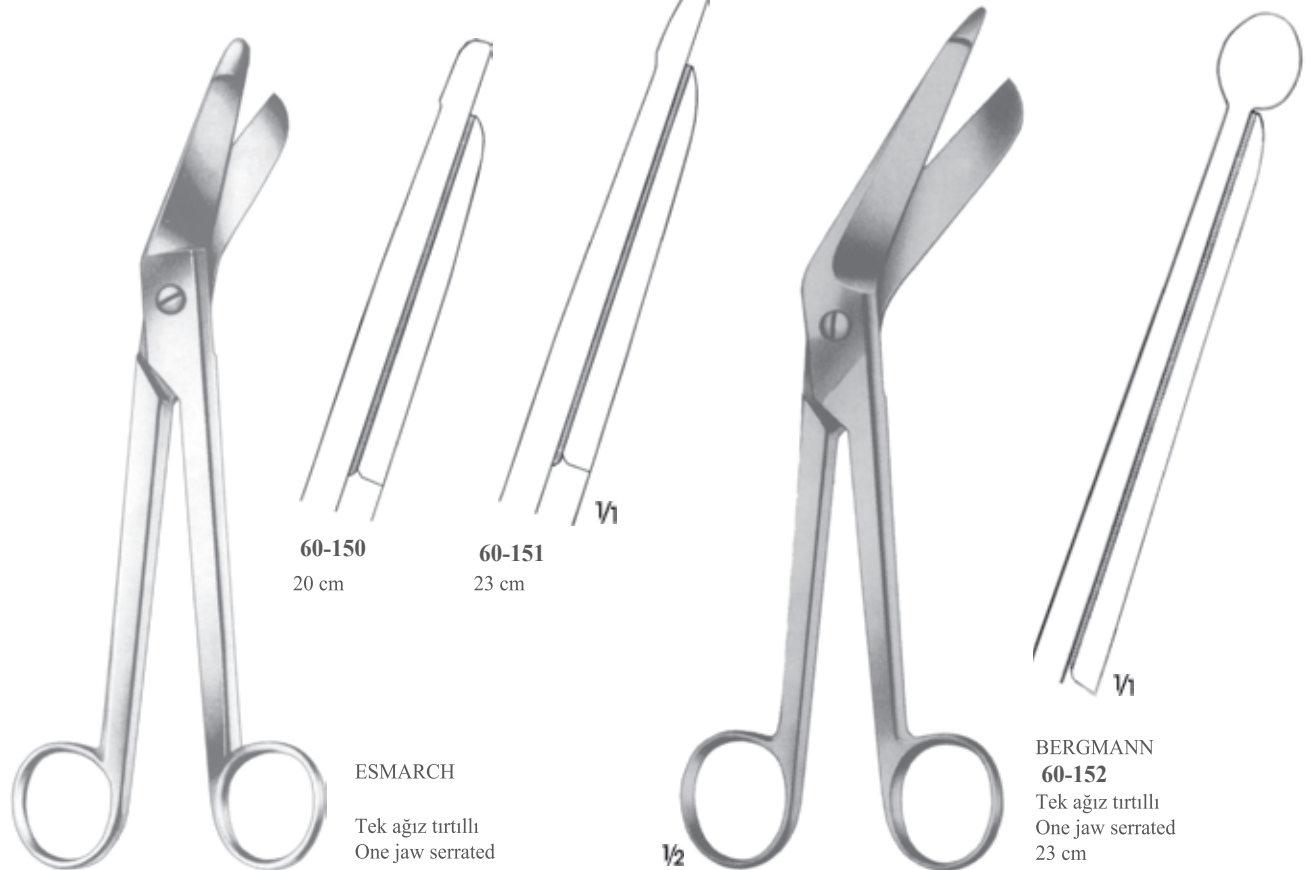
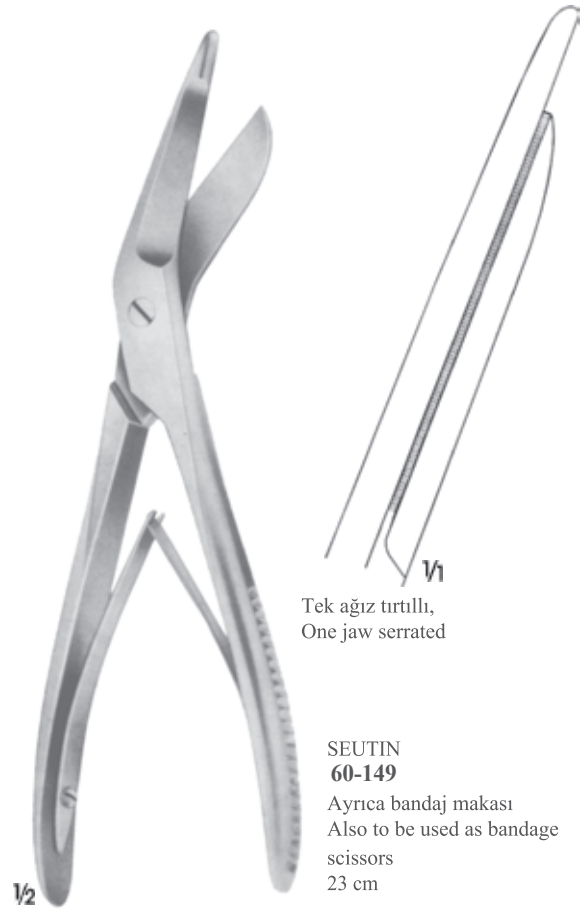
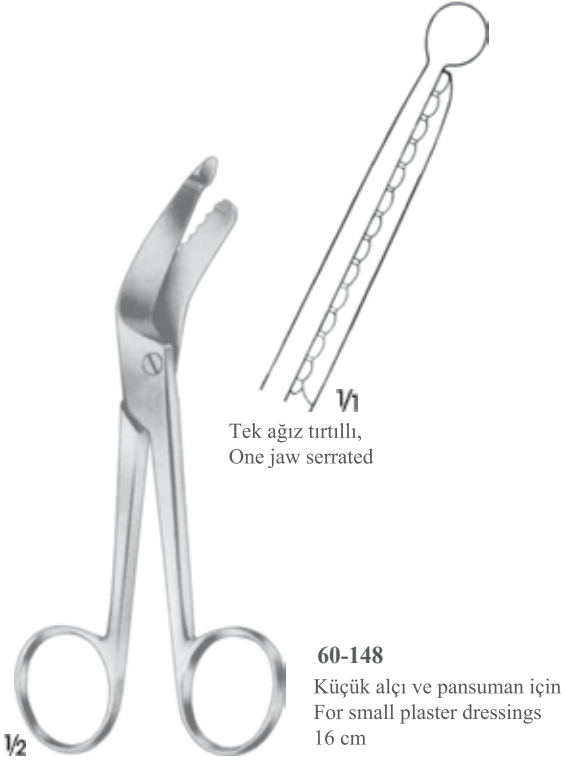
**60-146**  
13 cm



Yumuşak tel için Ø 1.5 mm  
For soft wire Ø 1.5 mm  
Sert tel için Ø 1.0 mm  
For hard wire Ø 1.0 mm

**60-147**  
Tel kesme pensi  
Wire cutting pliers  
14 cm







ESMARCH  
**60-153**  
Alçı bıçağı  
Plaster knife  
18 cm

1/2



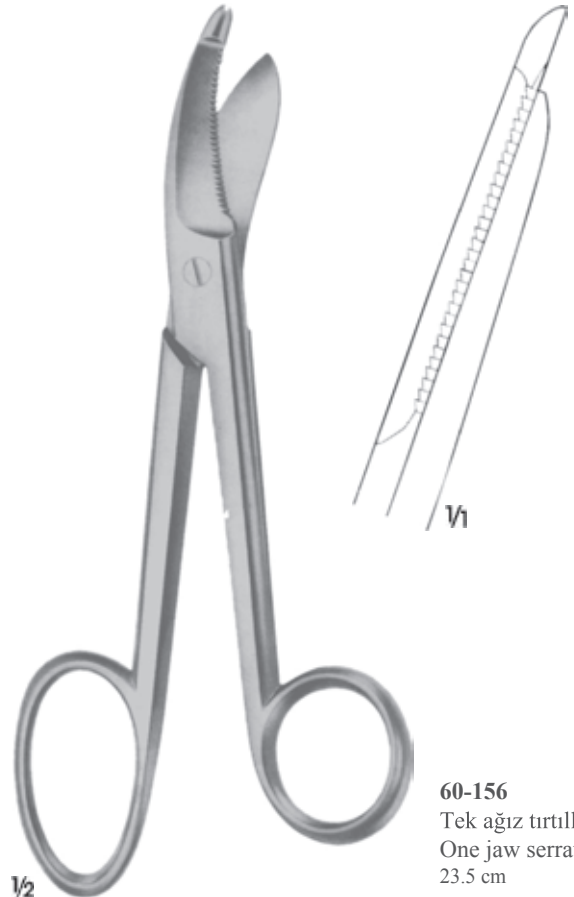
ENGEL  
**60-154**  
Alçı testeresi  
Plaster saw  
15 cm

1/2



BRUNS  
**60-155**  
23.5 cm

1/2



**60-156**  
Tek ağız tırtıllı  
One jaw serrated  
23.5 cm

1/2





1/3

STILLE  
60-157  
23 cm



1/3

STILLE  
60-158  
26 cm



1/3

STILLE  
60-159  
36 cm



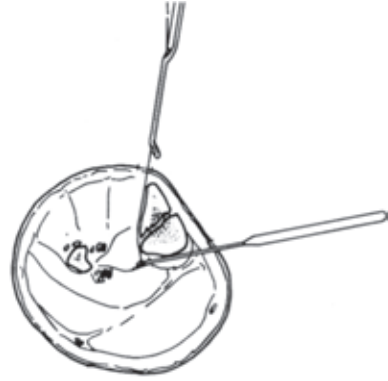
1/3

STILLE  
60-160  
37 cm



<b>60-160</b> Ø 0.2 mm	<b>60-163</b> Ø 0.5 mm	<b>60-166</b> Ø 0.8 mm	<b>60-169</b> Ø 1.2 mm
<b>60-161</b> Ø 0.3 mm	<b>60-164</b> Ø 0.6 mm	<b>60-167</b> Ø 0.9 mm	<b>60-170</b> Ø 1.5 mm
<b>60-162</b> Ø 0.4 mm	<b>60-165</b> Ø 0.7 mm	<b>60-168</b> Ø 1.0 mm	

Yumuşak doku uyumlu tel 10 m  
Wire, soft, tissue compatible, in coils of 10 m

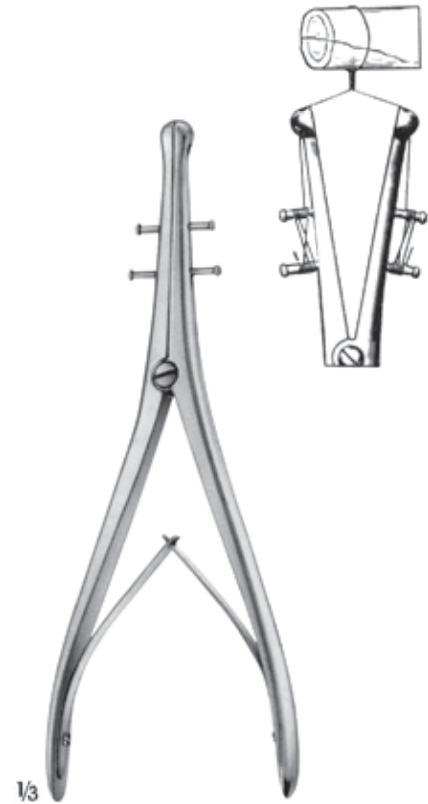


Implantlar için kullanılan malzemedan yapılmış hareketli uç. Bükülürken hareketli başlık sabit kalır bu sayede tel kalmaz.  
Movable tip made of material used for implants. While twisting the movable head remains stable, therefore the wire will not slip off.

1/2

LOUTE  
**60-171**

Tel gerici, geliştirilmiş model, hareketli uç ile 1.0 mm çapına kadar olan teller için  
Wire tightener, improved pattern, with movable tip, for wires up to 1.0 mm diam  
22 cm



1/3

DEMEL  
**60-172**

Gerdirek tel sıkma, büküm pensi  
Wire tightening-and twisting forceps  
27 cm



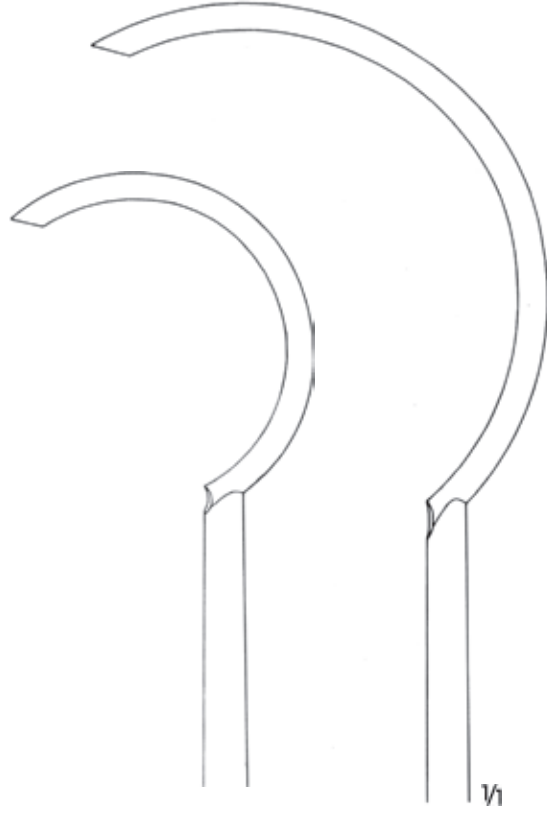




**60-173**  
22.5 cm



**60-174 - 60-175**

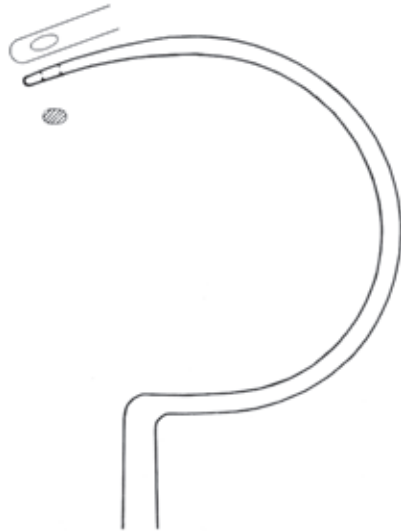


**60-174**  
24 cm

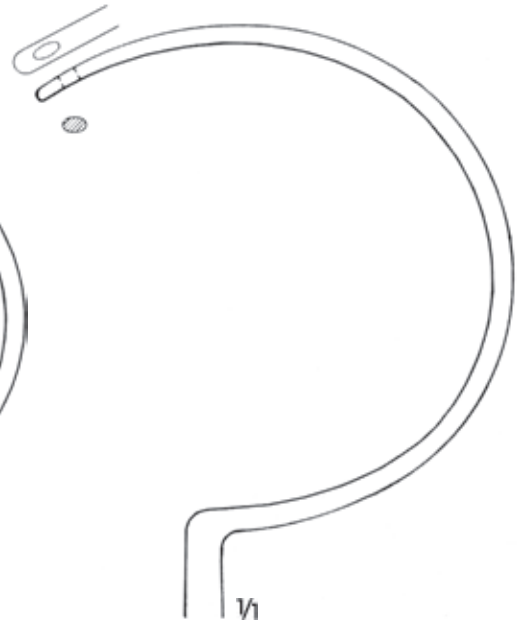
**60-175**  
27 cm



**60-176**  
27.5 cm



**60-177**  
28.5 cm



**60-178**  
30.5 cm

DEMEL

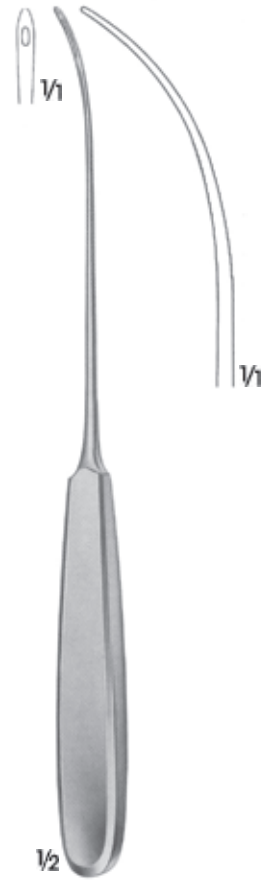
Tel kılavuzları/Wire guides



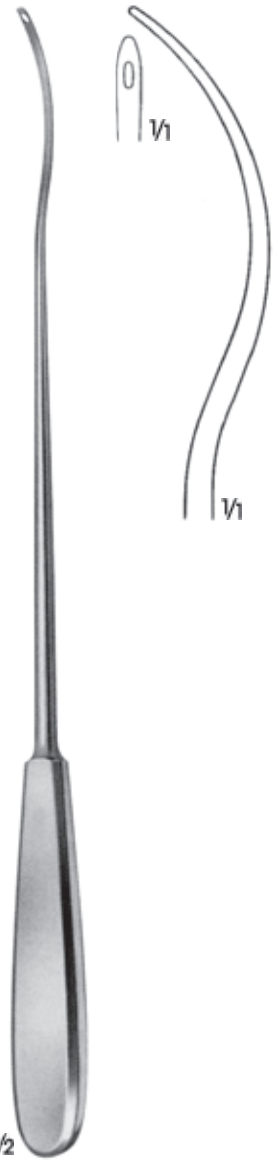
**OBWEGESER  
60-179**  
19.5 cm



**OBWEGESER  
60-180**  
23 cm



**BRUNNER  
60-181**  
Bükülebilir/Malleable  
23 cm



**BRUNNER  
60-182**  
30 cm





**60-183**  
Delme başlığı  
Drilling chuck  
Ø 0.8-2 mm  
15 cm



**60-184**  
Delme başlığı Ø 4.5 mm  
Drilling chuck Ø 4.5 mm  
T30-092 anahtarı ile  
With key T30-092  
14 cm



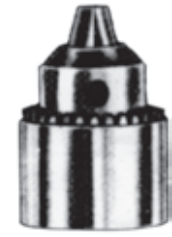
**60-185**  
Delme başlığı Ø 6.35 mm  
Drilling chuck Ø 6.35 mm  
T30-090 anahtarı ile  
With key T30-090  
16 cm



**60-186**  
Anahtar/Key



**60-187**  
Anahtar/Key

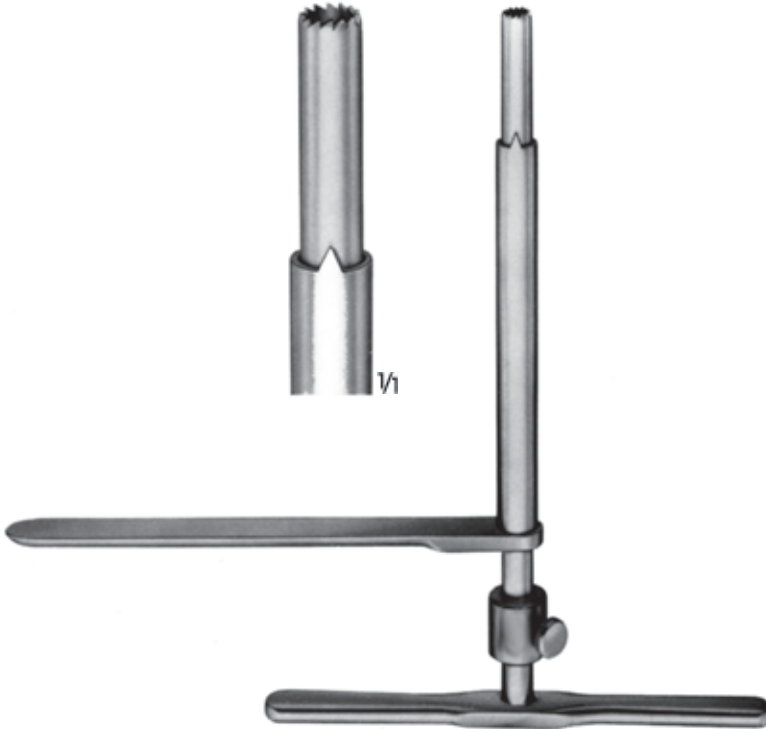


**60-188** Anahtarı ile  
With key

İç çap/İnside Ø 6.7 mm  
Dış çap/Outside Ø 8.7 mm



1/1



R.N.O.H.  
**60-189**  
Kemik biyopsi trapanı  
Bone biopsy trephine  
19.5 cm



1/2



**60-190**  
İç çap/İnside Ø 3.9 mm  
Dış çap/Outside Ø 5 mm



**60-191**  
İç çap/İnside Ø 6.4 mm  
Dış çap/Outside Ø 8 mm



1/2

Kemik biyopsi trapanı  
Bone biopsy trephine  
16 cm

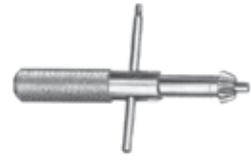




Ayarlı sap  
Adjustable handle

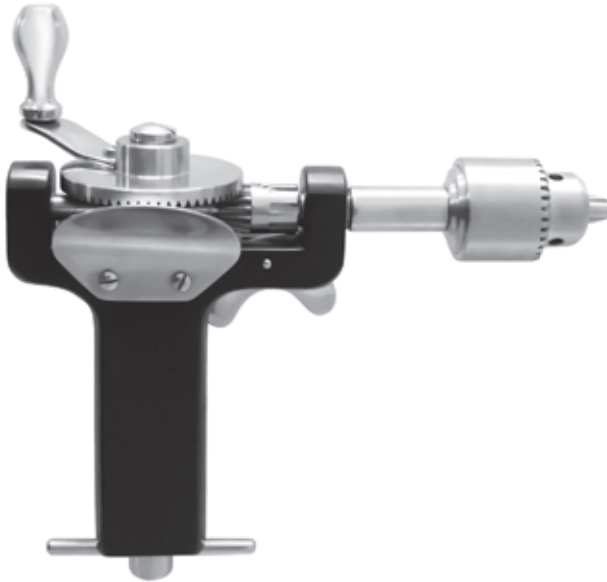
**60-192**

El matkabı/Hand drill only  
28 cm



**60-193**  
Anahtar/Key

El matkabı paslanmaz, 3 çene ağızlı, 6.35 mm çaplı başlıklar için uygundur. Orjinal 'Jacops Chuck' aynaları ile ve **60-193** anahtarı ile, anahtarlı veya anahtarsız kullanılabilir.  
Hand drill, stainless, original 'Jacops Chuck' and key  
Can be used with or without the key.



**60-195**  
Anahtar/Key

BUNNEL

**60-194**

Küçük el matkabı, KIRSCHNER tel için delikli küçük el matkabı, 3 çene ağızlı, 4 mm çaplı başlıklar için uygundur.  
Small hand drill, canulated for KIRSCHNER wires, with 3-jaw chuck, to fit any size of shanks up to 4.0 mm diameter.

**60-195** anahtarı ile

With key T

16 cm



**60-196**  
20 cm

**60-197**  
25 cm



**60-198**  
20 cm

**60-199**  
25 cm



**60-200**  
20 cm

**60-201**  
25 cm



**60-202**  
20 cm

**60-203**  
25 cm



**60-204**  
20 cm

**60-205**  
25 cm



3.5 mm



**60-206**  
20 cm

**60-207**  
25 cm



2.5 mm

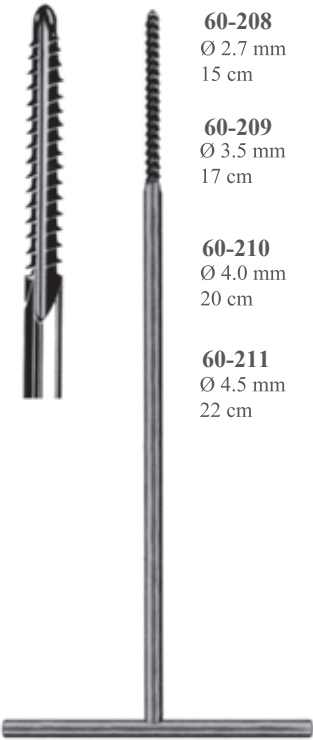


**60-208**  
Ø 2.7 mm  
15 cm

**60-209**  
Ø 3.5 mm  
17 cm

**60-210**  
Ø 4.0 mm  
20 cm

**60-211**  
Ø 4.5 mm  
22 cm



Kemik tapları/Bone taps



**60-212**  
15.5 cm

Ölçme sınırı  
Measuring  
6 - 40 mm

Vidalar için  
For screws  
Ø 2.7 mm  
Ø 3.5 mm  
Ø 4.0 mm



**60-213**  
22 cm

Ölçme sınırı  
Measuring  
10 - 60 mm

Vidalar için  
For screws  
Ø 4.5 mm  
Ø 6.5 mm



**60-214**  
Plak tutucu pens  
Plate holding forceps  
20 cm



Elmas Kesici Ağız  
With Carbide Cutting Edges



**60-215**  
1.5 mm



**60-216**  
20 cm



**60-217**  
ile kullanılır.  
To be use with

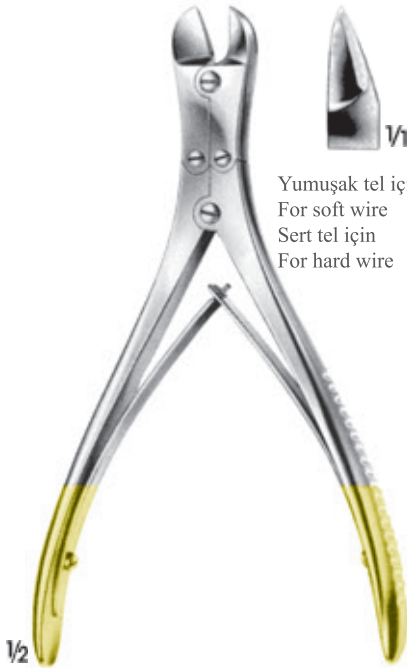


**60-218**  
Ø 2.5 mm



**60-219**  
Pin/Pin

Kılavuz/Guide  
23 cm



1/2

REILL  
**60-220**  
Kemiğe yakın olan telleri kesme  
For cutting off wires close to the bone  
17.5 cm



1/1

Yumuşak tel için Ø 2.0 mm  
For soft wire Ø 2.0 mm  
Sert tel için Ø 1.5 mm  
For hard wire Ø 1.5 mm



**60-221**  
15 cm



**60-222**  
10 cm



**60-223**  
10 cm



**60-224** Ø 2.5 mm  
**60-225** Ø 3.5 mm  
14 cm



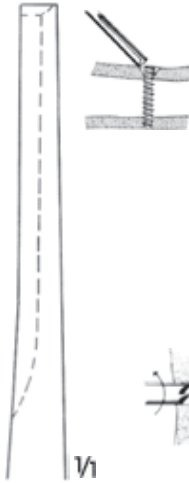
**60-226** Ø 3.5 mm  
18 cm



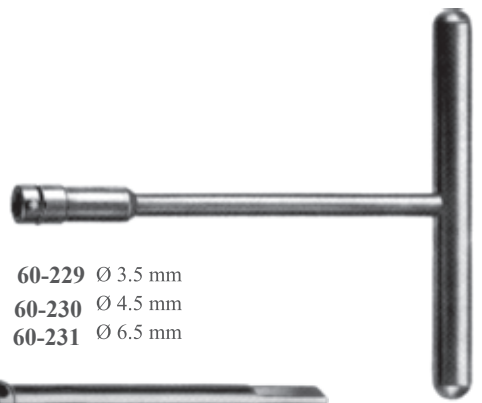
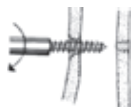
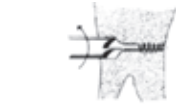
**60-227**  
20 cm



**60-228** 9 mm  
Kırık vida çıkartıcı guj  
Broken screw extractor guj  
22 cm



V1



**60-229** Ø 3.5 mm  
**60-230** Ø 4.5 mm  
**60-231** Ø 6.5 mm



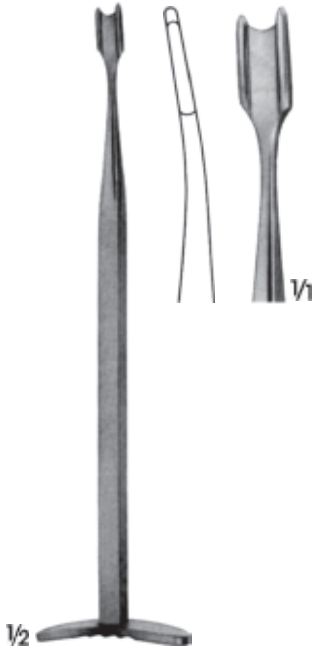
**60-232** Ø 3.5 mm  
**60-233** Ø 4.5 mm  
**60-234** Ø 6.5 mm



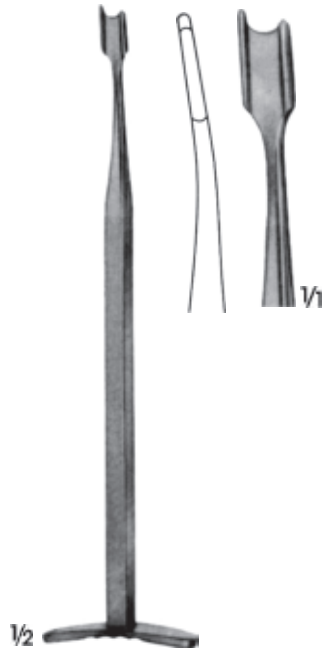
**60-235** Ø 3.5 mm  
**60-236** Ø 4.5 mm  
**60-237** Ø 6.5 mm



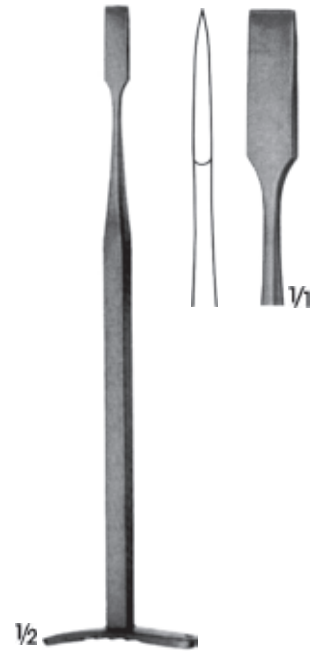
**60-238** Ø 3.5 mm  
**60-239** Ø 4.5 mm  
**60-240** Ø 6.5 mm



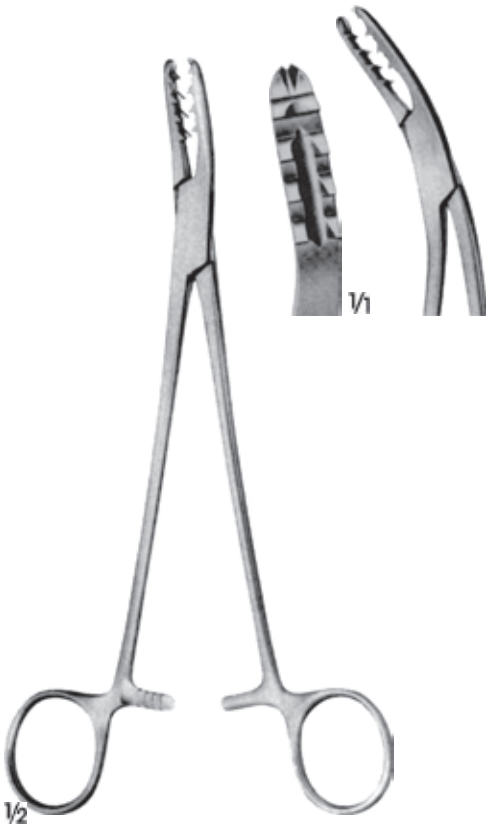
**SMILLIE**  
**60-241**  
Menisküs bıçak  
Meniscus knife  
17 cm



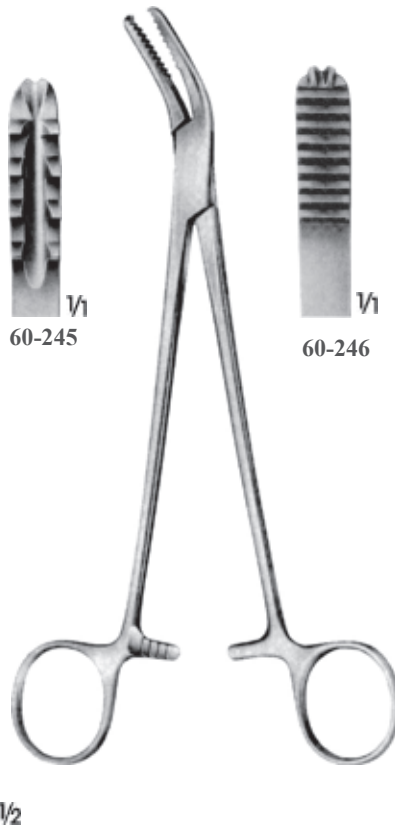
**SMILLIE**  
**60-242**  
Menisküs bıçak  
Meniscus knife  
17 cm



**SMILLIE**  
**60-243**  
Menisküs bıçak  
Meniscus knife  
17 cm



**BIRCHER-GANSKE**  
**60-244**  
Menisküs pensi  
Meniscus forcep  
20 cm

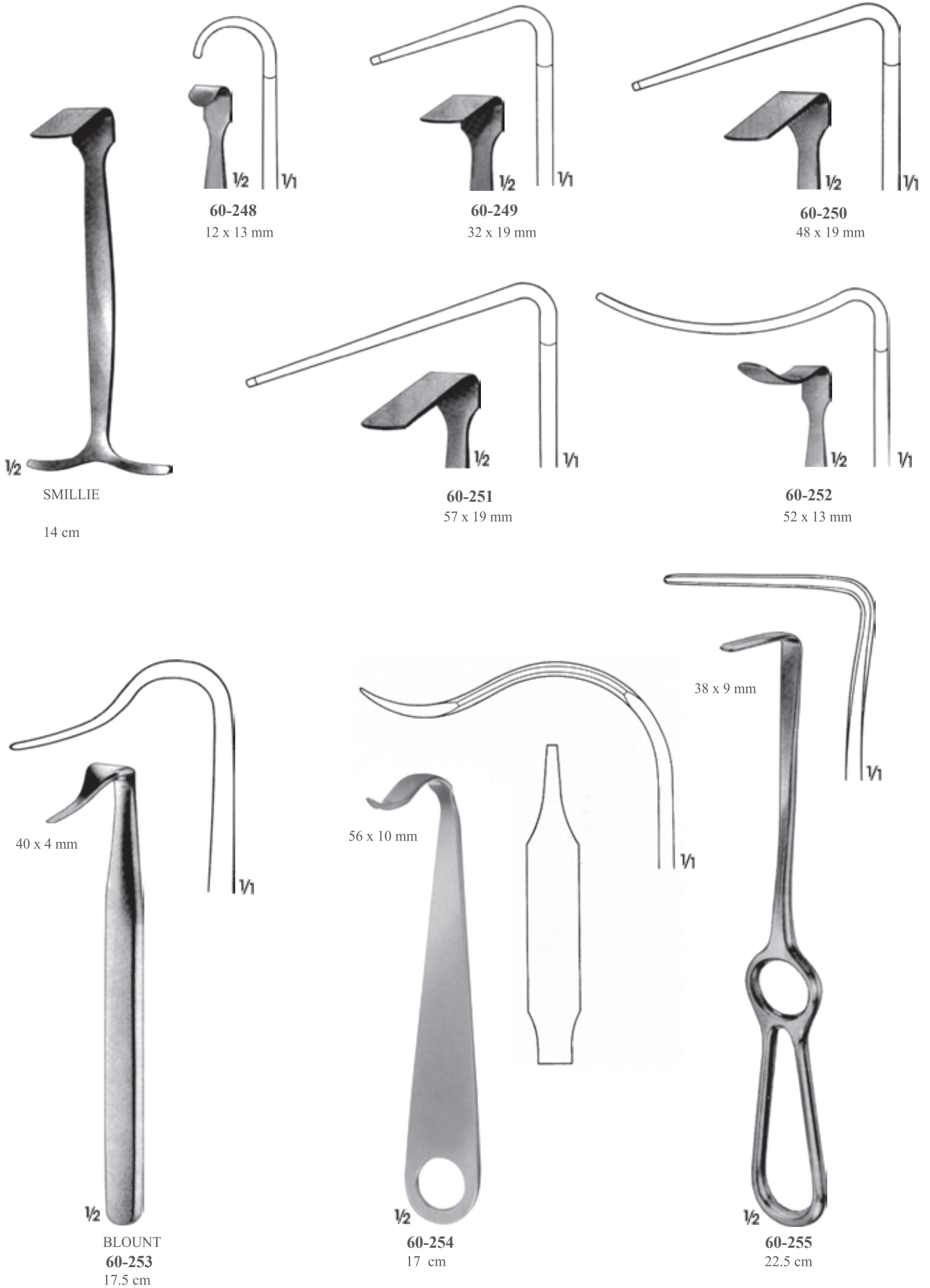


**WELLER**  
Menisküs pensi  
Meniscus forcep  
20 cm



**60-247**  
Menisküs pensi  
Meniscus forcep  
20.5 cm







**60-256**  
Kalça ekartörü  
Hip retractor



**60-257**  
Zincirli ağırlık  
Weight with chain  
1 kg



**60-258**  
Çıkartıcı/Extractor  
25 cm



**60-259**  
Çıkartıcı/Extractor  
27 cm



**60-260**  
İtici/Pusher  
25 cm



**60-261**  
MORE protez çıkartıcı  
MORE protheses extractor  
50 cm



Osteotom ve guj  
Chisel and gouge  
35 cm

**60-262**  
5 mm



**60-263**  
7 mm



**60-264**  
10 mm



Osteotom/Çizil  
Osteotome/Chisel

**60-265**  
5 mm



**60-266**  
7 mm



**60-267**  
10 mm



Guj/Gouge

**60-268**  
5 mm



**60-269**  
7 mm



**60-270**  
7 mm



Guj/Gouge



**60-271**  
Çement itici  
Cement pusher  
30 cm



**60-272**  
Çement itici  
Cement pusher  
30 cm



60-273 Ø 7 mm  
60-274 Ø 9 mm  
60-275 Ø 11 mm  
Çement çıkartıcı  
Cement extractor  
60 cm



60-276 Ø 6 mm  
40 cm



60-277 Ø 8 mm  
40 cm



60-278 Ø 10 mm  
40 cm



60-279 Çekiç / Mallet  
22 cm



60-280 40 cm

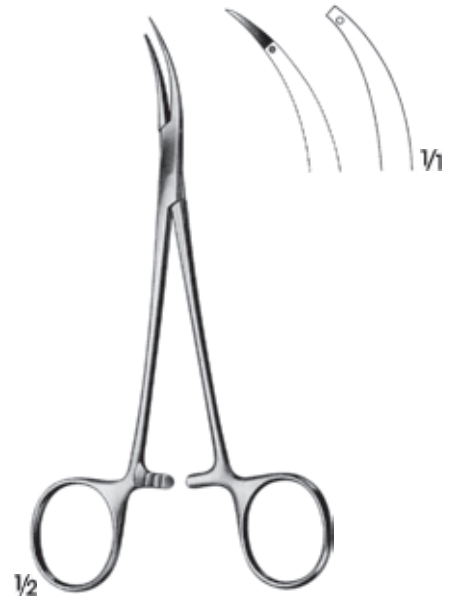




HERZ  
**60-281**  
Tendon tutucu pens  
Tendon seizing forcecep  
15.5 cm



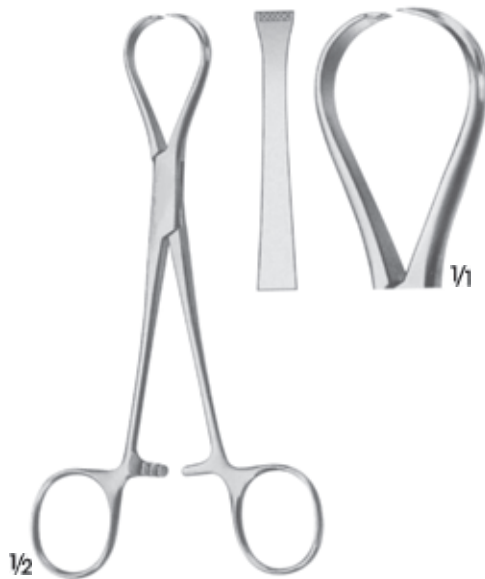
**60-282**  
Tendon geçmeli pens  
Tendon interlacing forcecep  
15 cm



**60-283**  
Tendon geçmeli pens  
Tendon interlacing forcecep  
15 cm



SYSTRUNK  
**60-284**  
Parmak tırnak kesme makası  
Scissors for splitting finger nails  
13 cm



JACKSON  
**60-285**  
Tendon tutucu pens  
Tendon seizing forcecep  
4 x 5 diş/4 x 5 teeth  
15 cm



JOSEPH  
**60-286**  
El testere  
Hand saw  
17 cm



LINDEMANN  
**60-287**  
El testere  
Hand saw  
20 cm





REILL  
**60-288** Ø 4 mm  
Tendon stripper  
Tendon stripper  
Şaft uzunluğu  
Shaftlänge 35 cm  
Toplam boy  
Shaft length 39.5 cm



ASSMUS  
**60-289** Ø 3 mm  
Sinir stripper, Kunt  
Nerve stripper, blunt  
Şaft uzunluğu  
Shaftlänge 35 cm  
Toplam boy  
Shaft length 39.5 cm



**60-290** Ø 3 mm  
Tendon stripper  
Tendon stripper  
Şaft uzunluğu  
Shaftlänge 19 cm  
Toplam boy  
Shaft length 30 cm



**60-291** Ø 5 mm  
Tendon stripper  
Tendon stripper  
Şaft uzunluğu  
Shaftlänge 39 cm  
Toplam boy  
Shaft length 49.5 cm

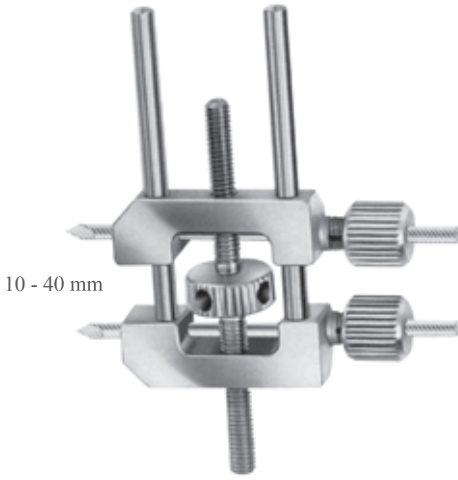


BUNNELL

60-292 Ø 2 mm  
60-293 Ø 3 mm  
60-294 Ø 4 mm  
60-295 Ø 6 mm  
13.5 cm

60-296 Ø 3 mm  
60-297 Ø 5 mm  
30 cm

60-298 Ø 5 mm  
50 cm



10 - 40 mm

**60-299**  
Küçük distraktör  
Small distractor  
Tel Ø 3.0 mm  
For wires Ø 3.0 mm



**60-300**  
Sabitleme diski kanallı  
Fixation disc, slotted



**60-301**  
Aliminyum, x ışınlarını  
geçirgen  
Fixation disc, slotted idem,  
alüminyum transparent to  
X-rays



**60-302**  
Sabitleme diski, kanallı  
Fixation disc, slotted



**60-303**  
Kavrama çeneli tel gerdirme aleti  
Wire tightener with clamping jaws



**60-304**  
Tespit klempini için/For fixation clamp



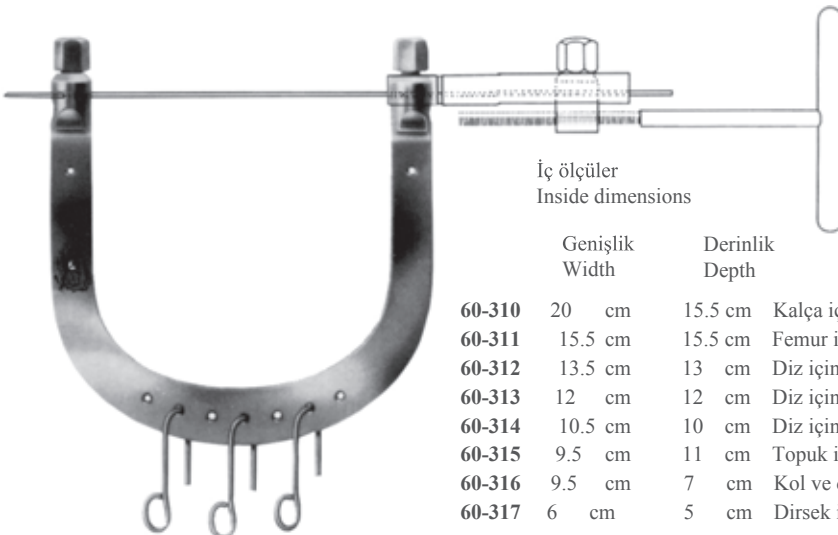
**60-305**  
Büyük boy traksiyon kancası  
Large size traction hook



**60-306**  
Küçük boy traksiyon kancası  
Small size traction hook



**60-307**  
Traksiyon yayı anahtarı  
Wrench, double-ended, for wire



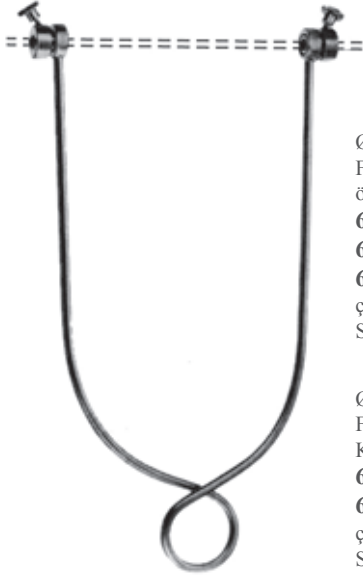
KIRSCHNER

3 kancalı, Ø 2.5 mm'ye kadar KIRSCHNER teli ile kullanılan çektirme  
Wire traction bows, to be used with KIRSCHNER wires up to Ø 2.5 mm, with 3 hooks

İç ölçüler  
Inside dimensions

	Genişlik Width	Derinlik Depth	
<b>60-310</b>	20 cm	15.5 cm	Kalça için/For the hip
<b>60-311</b>	15.5 cm	15.5 cm	Femur için/For the femur
<b>60-312</b>	13.5 cm	13 cm	Diz için/For the knee
<b>60-313</b>	12 cm	12 cm	Diz için/For the knee
<b>60-314</b>	10.5 cm	10 cm	Diz için/For the knee
<b>60-315</b>	9.5 cm	11 cm	Topuk için/For the calcaneus
<b>60-316</b>	9.5 cm	7 cm	Kol ve dirsek için/For the arm and elbow
<b>60-317</b>	6 cm	5 cm	Dirsek için, çocuklar için/For the elbow child size





Ø 4 mm STEINMANN çivileri için  
For Ø 4 mm STEINMANN pins Kol  
ölçüleri/Arms dimensions  
**60-319** 16 x 9 cm  
**60-320** 21 x 11 cm  
**60-321** 21 x 15 cm STEINMANN  
çivileri hariç Except for  
STEINMANN pins

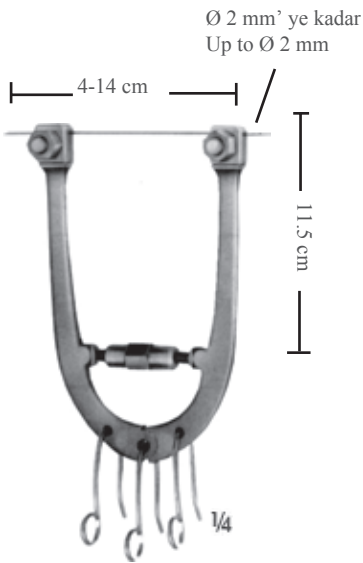
Ø 5 mm STEINMANN çivileri için  
For Ø 5 mm STEINMANN Pins  
Kol ölçüleri/Arms dimensions  
**60-322** 16 x 9 cm  
**60-323** 21 x 11 cm STEINMANN  
çivileri hariç Except for  
STEINMANN pins



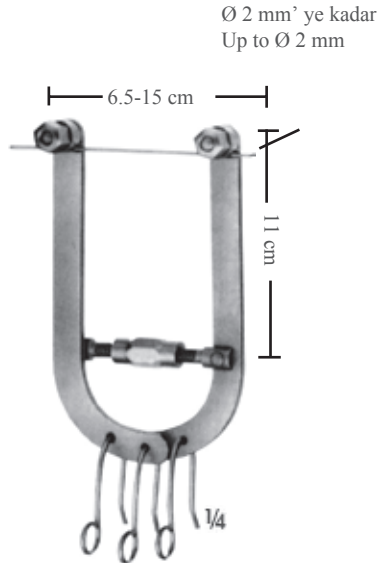
**60-318**  
Sabitleme diskleri için tornavida  
Screw driver for fixation discs



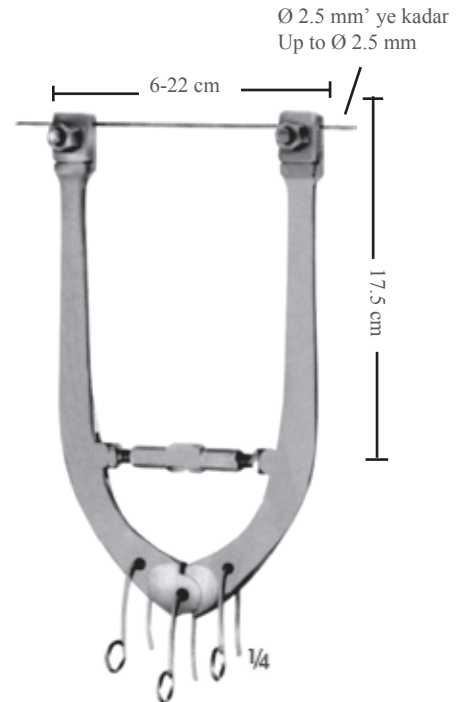
**60-324** 1 kg  
**60-325** 2 kg  
**60-326** 5 kg  
Ağırlık/Weight



**60-327**  
Ayarlı küçük boy, üç kancalı traksiyon aleti  
Wire traction bow, adjustable, with 3 hooks,  
small size



**60-328**  
Ayarlı küçük boy, üç kancalı traksiyon aleti  
Wire traction bow, adjustable, with 3 hooks,  
small size



**60-329**  
Ayarlı büyük boy, üç kancalı traksiyon aleti  
Wire traction bow, adjustable, with 3 hooks,  
large size

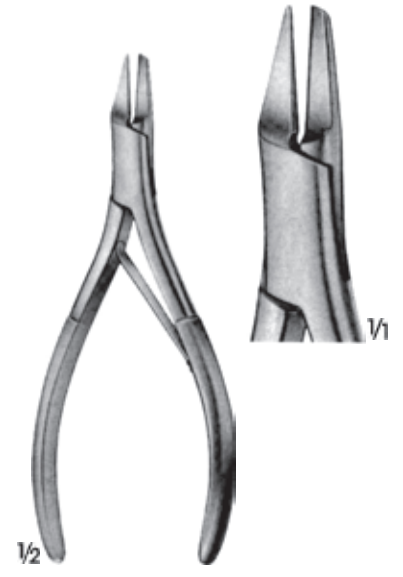


**60-331**  
Yedek bleyd  
Spare blade

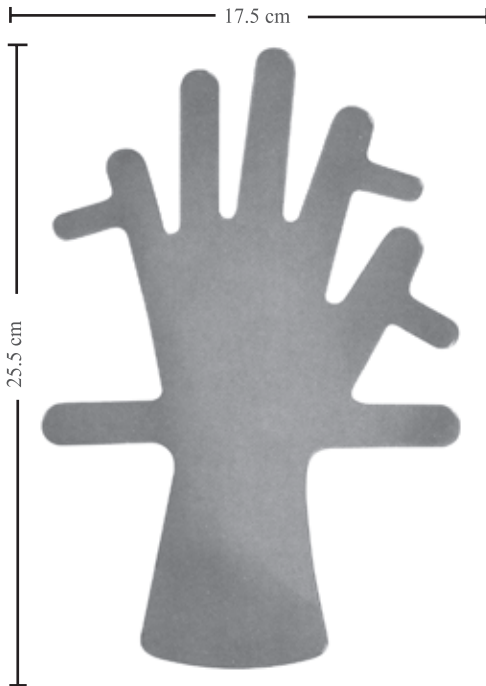
**60-330**  
Parmak yüzük testere  
Finger ring saw  
15 cm



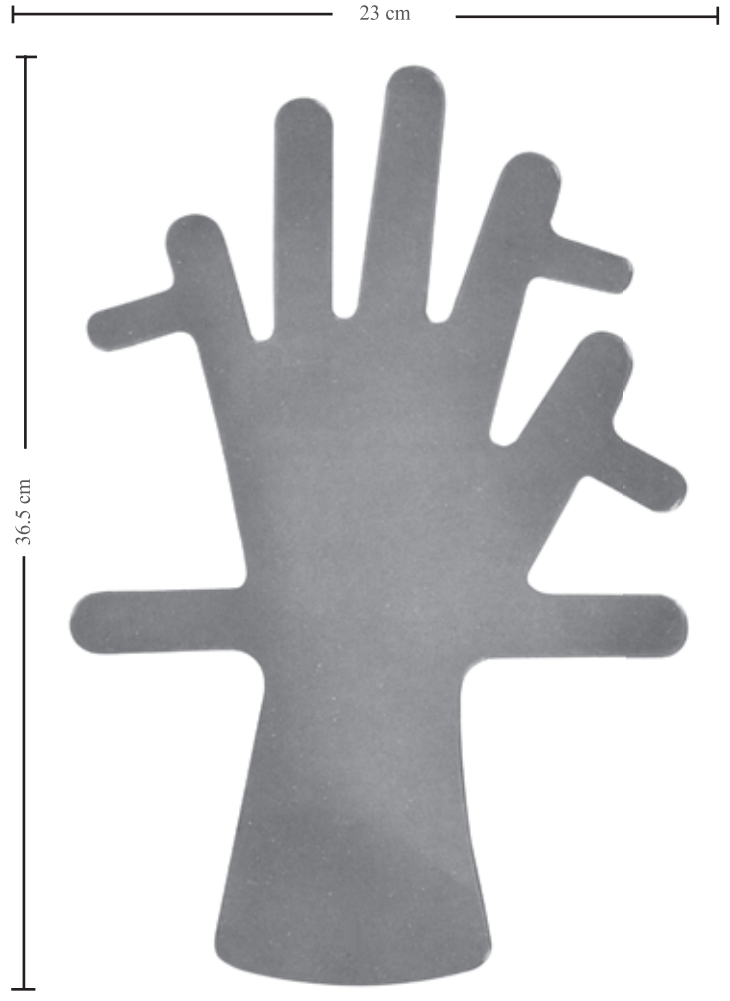
**60-332**  
Tırnak çıkarma pensi  
Nail extracting forceps  
13.5 cm



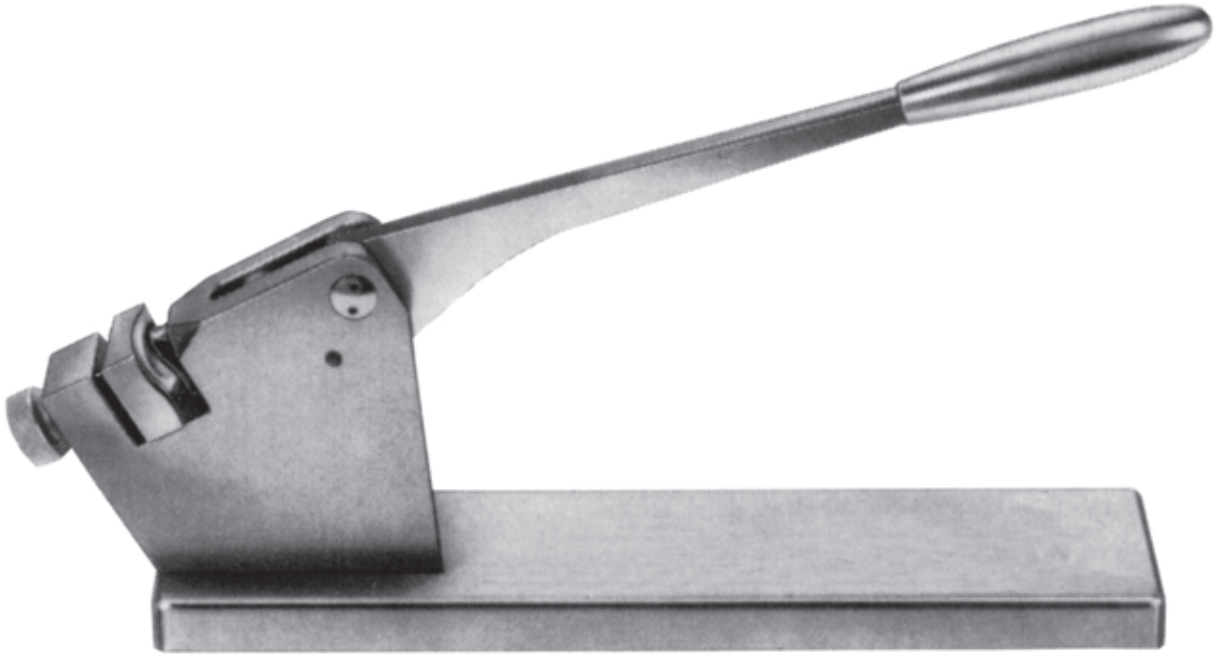
**60-333**  
Tırnak çıkarma pensi  
Nail splitting forceps  
13 cm



**60-334**  
Çocuklar için el sabitleyici, yumuşak  
Children's hand control, soft



**60-335**  
Yetişkinler için el sabitleyici, yumuşak  
Used stabilizer for adults, soft



**60-336**  
Bükme ve kıvrırma aparatı  
Plate bending and contouring device



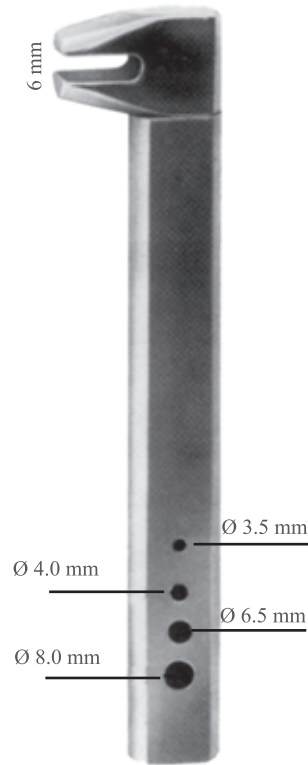
**60-337**  
Bükme kolu  
Bending iron  
14 cm



**60-338**  
Bükme kolu  
Bending iron  
14 cm



**60-339**  
Bükme kolu  
Bending iron  
16 cm



**JEWETT**  
**60-340**  
Bükme kolu  
Bending iron  
20 cm



**JEWETT**  
**60-341**  
Bükme kolu  
Bending iron  
20 cm





**61**

LANGENBECK

**61-100**

Metakarpal testeresi

Metacarpal saw

Ağız uzunluğu

Length of blade

11.5 cm

23.5 cm



1/2

**61-102**

Bleyd uzunluğu

Length of blade

20 cm



1/3

**61-103** 18 cm

**61-104** 24 cm

Ağız uzunluğu

Length of blade



1/2

LEBSCHE

**61-105**

Tel testeresi için klavuz

Conductor for wire saws

Bükülebilir/Malleable

25 cm



1/2

DE MARTEL

**61-106** 35 cm

Kondüktör için gigli testere teli, esnek

Gigli saw for the flexible conductor wire



1/2



1/4

GIGLI  
**61-107**  
Sap/Handle



GIGLI  
**61-108** 30 cm  
**61-109** 40 cm  
**61-110** 50 cm  
İki sargılı/Two windings



GIGLI  
**61-111** 30 cm  
**61-112** 40 cm  
**61-113** 50 cm  
Üç sargılı/Three winding

**61-114** Komple/Complete  
61-115, 61-116, 61-117

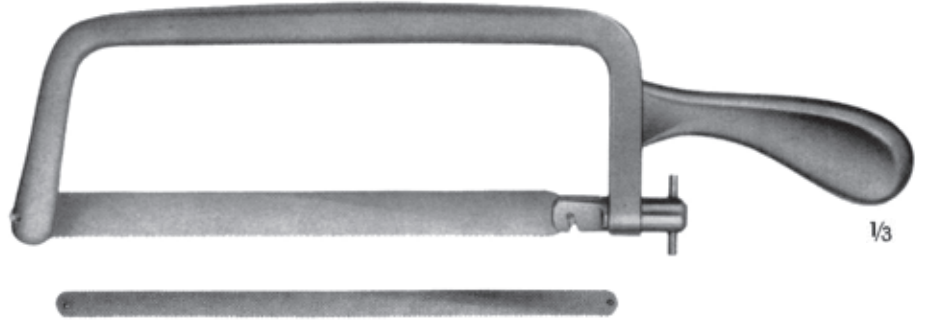
CHARRIERE

**61-115**  
Sadece sap/Only handle  
35 cm

**61-116** 12 mm

**61-117** 18 mm

Bleyd uzunluğu  
Length of blade  
21.5 cm



**61-118** Komple/Complete  
61-119, 61-120, 61-121 (1  
adet/1 each)  
61-123 (2 adet/2 each)

RUST

**61-119**  
Sadece sap/Only handle  
39 cm

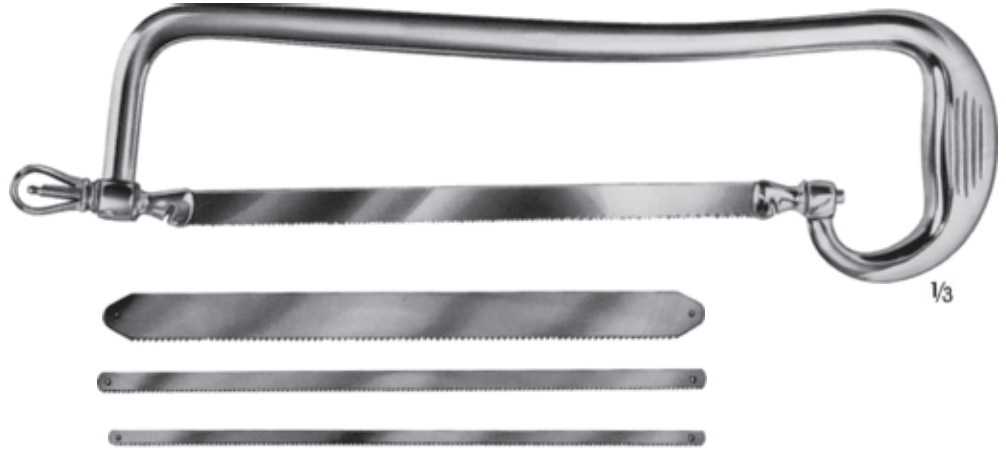
**61-120** 6 mm

**61-121** 8 mm

**61-122** 12 mm

**61-123** 18 mm

Bleyd uzunluğu  
Length blade  
23.5 cm



BIER

**61-124** Komple/Complete  
61-125, 61-126, 61-127  
61-128

**61-125**  
Sadece sap/only handle  
42 cm

**61-126** 4 mm

**61-127** 6 mm

**61-128** 8 mm

Bleyd uzunluğu  
Length blade  
27 cm





**61-129**  
21 cm



**61-130**  
21 cm



**61-131** 19.5 cm  
**61-132** 22.5 cm



**61-133** 23 cm



**SEMB**  
**61-134**  
19 cm



**FERGUSSON**  
**61-135**  
20.5 cm

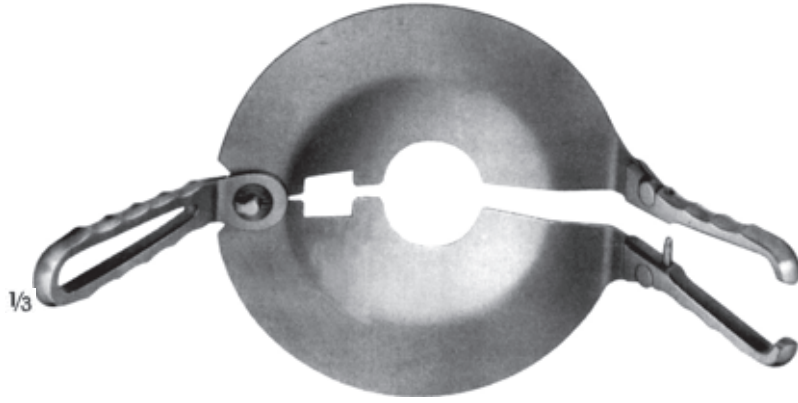


**STILLE**  
**61-136** 8 mm  
**61-137** 10 mm  
**61-138** 12 mm  
**61-139** 15 mm  
**61-140** 20 mm  
**61-141** 25 mm

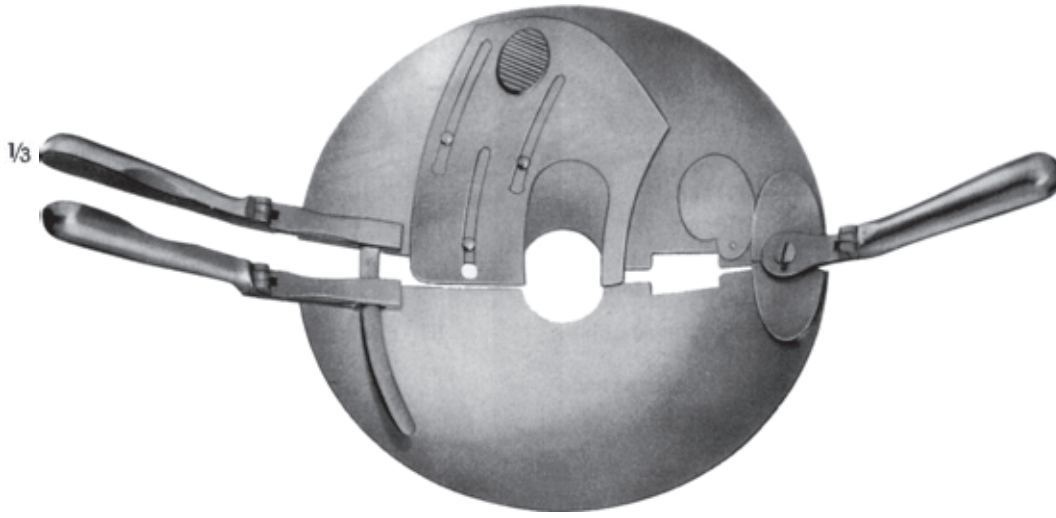


**BERGMANN**  
**61-142** 245 gr.  
23.5 cm





PERCY  
**61-143**  
Sökülebilir saplı  
Removable handles

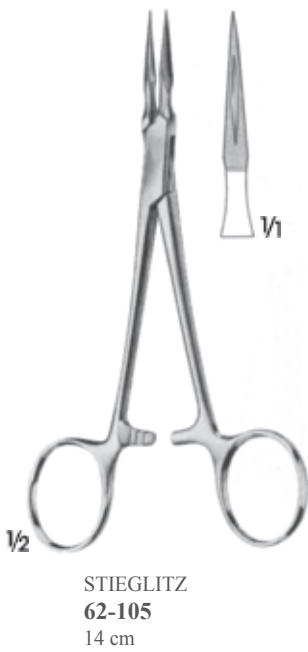
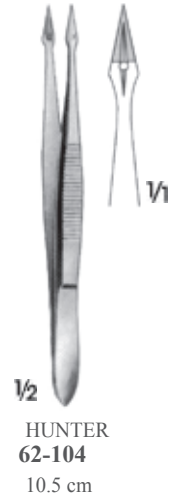
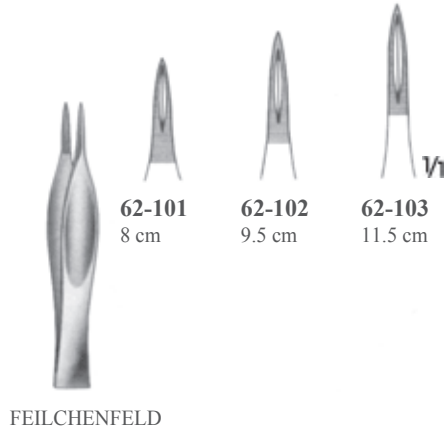


PERCY  
**61-144**  
Ters çevrilebilir saplı  
Reversible handles



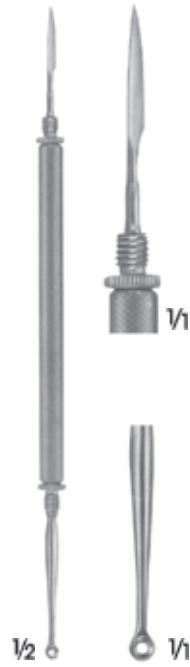


**62**





SAALFELD  
62-108  
10 cm



HEBRA  
62-109  
18 cm



62-110  
14.5 cm



UNNA  
62-111  
14 cm



VIDAL  
62-112  
13.5 cm



KILNER  
62-113  
16 cm



SCHAMBERG  
62-114  
10 cm



FOX  
14 cm



62-115  
4 mm



62-116  
5 mm



62-117  
6 mm



62-118  
7 mm



62-119  
4.3 mm



62-122  
5.3 mm



62-120  
5.8 mm



62-123  
6.3 mm



62-121  
6.4 mm

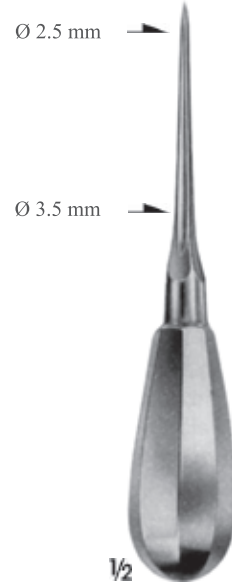


62-124  
7.2 mm





$\frac{1}{2}$   
**CHAMPIONNIERE**  
**62-125**  
Kemik matkabı  
Bone drill  
17 cm



$\frac{1}{2}$   
**62-126**  
Oyucu (Biz)  
Reamer (Awl)  
15 cm



$\frac{1}{2}$   
**62-127**  
Oyucu (Biz)  
Reamer (Awl)  
18 cm



$\frac{1}{2}$   
**62-128**  
Oyucu (Biz)  
Reamer (Awl)  
21.5 cm



- 62-129 Ø 2 mm
- 62-130 Ø 3 mm
- 62-131 Ø 4 mm
- 62-132 Ø 6 mm
- 62-133 Ø 7 mm

Deri pançaları  
Dermal punches

KEYES  
10 cm



KEYES

**62-134**

5 uçlu, komple deri pançı  
Dermal punch, complete with 5  
interchangeable tips, handle and  
rack







# ASCLASS

ASCLASS CERRAHİ ALETLER İMALAT SAN. VE TİC. LTD.ŞTİ

 [asclasscerrahialetler.ve.medya](https://www.instagram.com/asclasscerrahialetler.ve.medya)  [Asclass cerrahi aletler](https://www.facebook.com/Asclass.cerrahi.aletler)  [www.asclassgrup.com](http://www.asclassgrup.com)  [info@asclassgrup.com](mailto:info@asclassgrup.com) - [asclassmedya@gmail.com](mailto:asclassmedya@gmail.com)

 Çatalarmut Mahallesi Sezgin Sokak No:7 Kat:1/2/3 İlkadım/SAMSUN