



ASCLASS

ASCLASS CERRAHİ ALETLER İMALAT SAN. VE TİC. LTD.ŞTİ

📍 Çatalarmut Mahallesi Sezgin Sokak No:7 Kat:1/2/3 İlkadım/SAMSUN

📱 asclasscerrahialetler.ve.medya 🌐 Asclass cerrahi aletler 🌐 www.asclassgrup.com 📧 info@asclassgrup.com - asclassmedya@gmail.com

ÜRÜN GRUPLARIMIZ

- » Genel Cerrahi
- » Beyin Cerrahi
- » Ortopedi Cerrahi
- » Göz Cerrahi
- » Kulak Burun Boğaz
- » Jinekoloji
- » Üroloji
- » Kalp Damar
- » Üniversal Ekartör Setleri
- » Laparoskopik Ekartör Setleri
- » Laparoskopik El Aletleri
- » Steril Konteynir Sistem

51

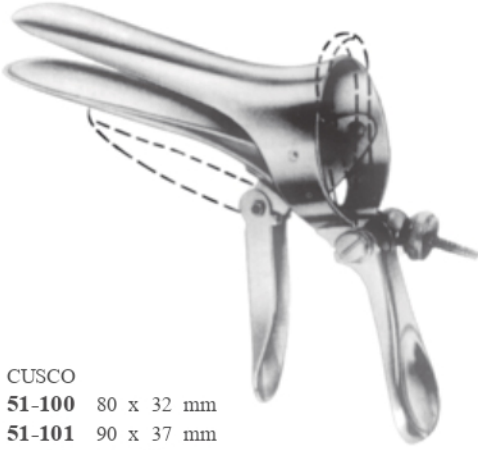

CUSCO

51-100 80 x 32 mm

51-101 90 x 37 mm

51-102 115 x 37 mm

Yassı (Ördek gagası)

Flat (Duck beak)

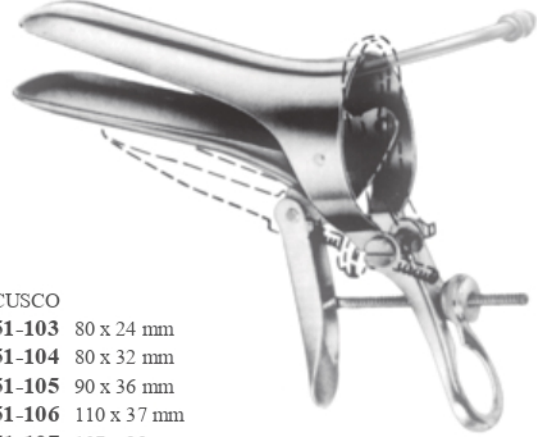

CUSCO

51-103 80 x 24 mm

51-104 80 x 32 mm

51-105 90 x 36 mm

51-106 110 x 37 mm

51-107 107 x 29 mm

51-108 115 x 35 mm

Aspiratör uçlu/With suction tube



GRAVE

51-109 75 x 20 mm

51-110 95 x 30 mm

51-111 105 x 33 mm



PEDERSON

51-112 100 x 22 mm

51-113 120 x 25 mm



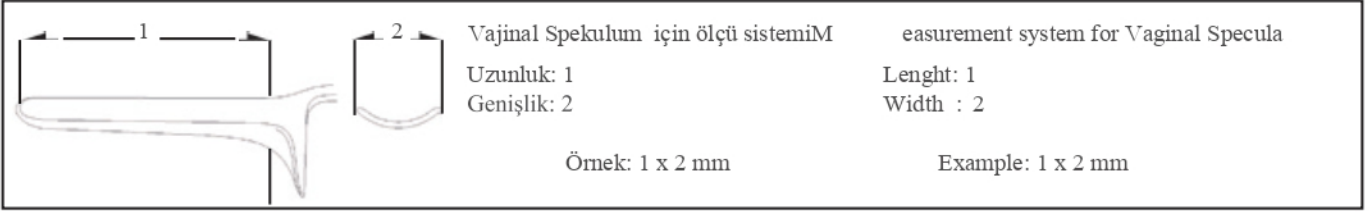

COLLIN
51-114
53 x 10 mm
Çocuklar için/For children



COLLIN
51-115
95/85 x 18 mm
Bakireler için/For virgins

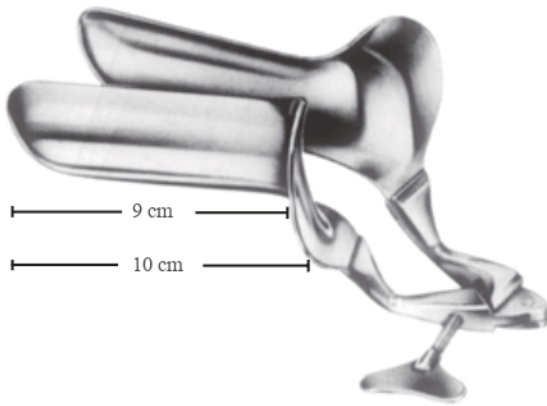

COLLIN	Tam boy/Çalışma boy Total length/Working length	En Width
51-116	100/90 mm	28 mm
51-117	100/90 mm	32 mm
51-118	105/95 mm	35 mm
51-119	115/105 mm	40 mm



TRELAT	En Width
51-120	85 x 33 mm
51-121	95 x 35 mm
51-122	115 x 43 mm

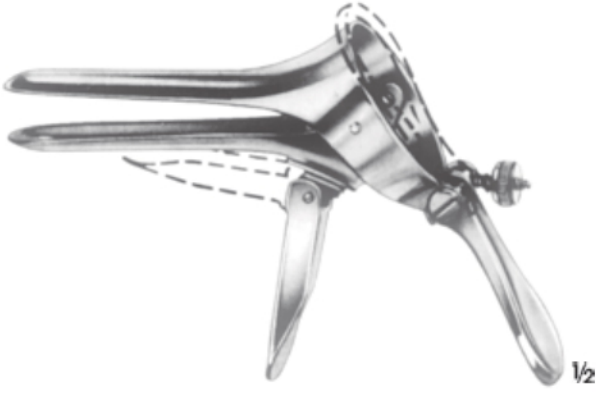

CUSCO
51-123
75 x 17 mm
Bakireler için/For virgins



CUSCO
51-124
75 x 17 mm
Bakireler için/For virgins



CUSCO STANDARD
51-125 80 x 24 mm
51-126 80 x 32 mm
51-127 90 x 36 mm
51-128 110 x 37 mm
Standart model Standard
patterns

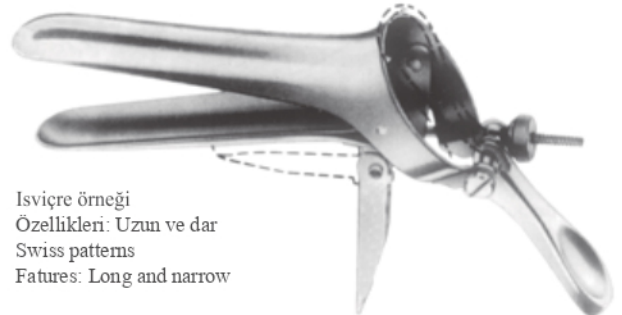

İsviçre örneği
Özellikleri: Uzun ve dar
Swiss patterns
Features: Long and narrow

CUSCO
51-129 92 x 23 - 25 mm
51-130 100 x 25 - 27 mm
51-131 110 x 27 - 30 mm





Parmak baskısıyla açılıp kapanan çift işaretli
With double ratchet, closing and opening of
ratchet by pressure of thumb

SEMM
51-132
90 x 14 -18 mm
Çocuk ve bakireler için
For children and virgins



Parmak baskısıyla açılıp kapanan çift işaretli
With double ratchet, closing and opening of
ratchet by pressure of thumb

SEMM
51-133 100 x 20 - 24 mm
51-134 100 x 30 - 34 mm
18.5 cm



Alet ve kataterleri çıkarmak için bir tarafı açık
One side open for faking up instruments and
catheters

SEYFFERT
51-135 100 x 17 mm
51-136 100 x 33 mm
23 cm



SEYFFERT
51-137 110 x 33 mm
23 cm





Hareketli çeneli
With movable jaws



1/2

COLLIN
51-138
26.5 cm



1/2

DARTIGUES
51-139
25.5 cm



1/2

SOMER
51-140
23.5 cm

Atromatik
Atraumatic

21 mm 27 mm

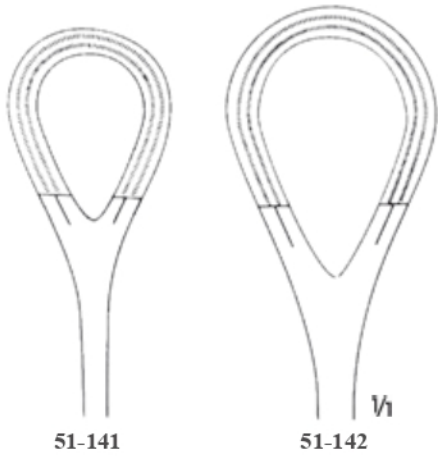

51-141 25 cm
51-142 27 cm



HEYWOOD-SMITH
51-143
20 cm



DOYEN
51-144
18.5 cm



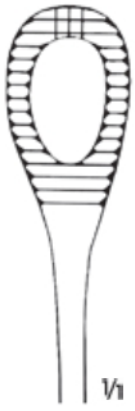

1/1



1/1

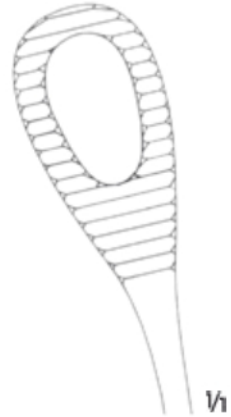

1/1



1/2

HEYWOOD-SMITH
51-145
25 cm

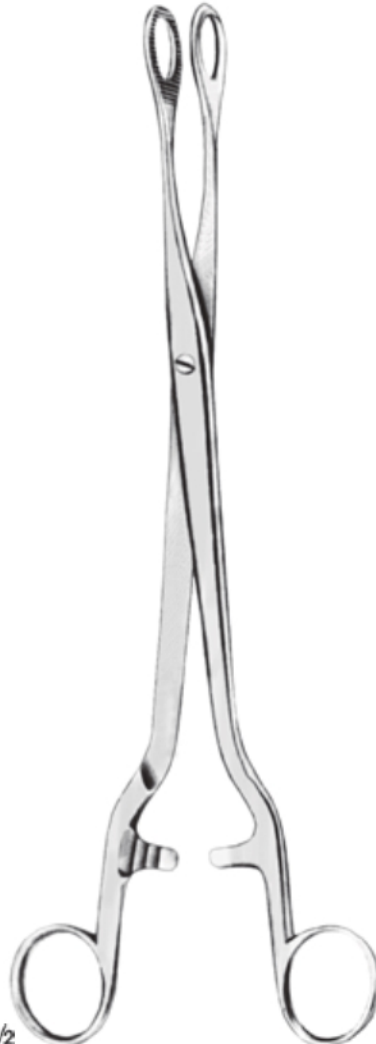

1/2

NOTO
51-146
28 cm

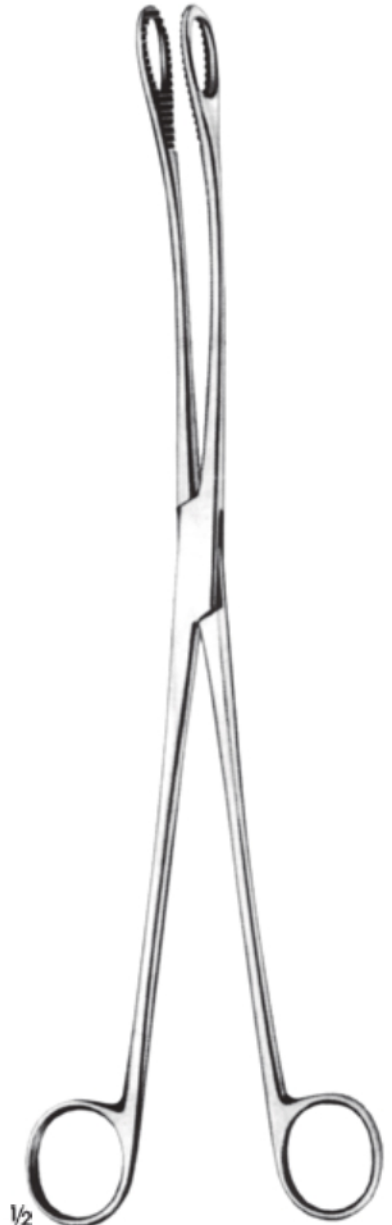

1/2

KELLY
51-147
32 cm

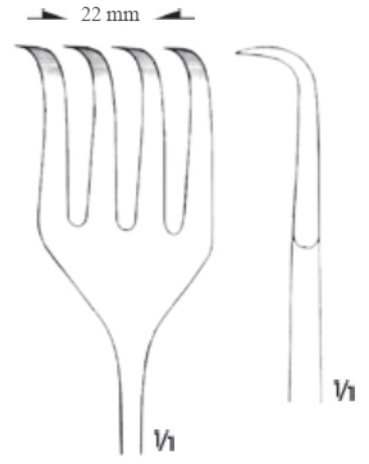
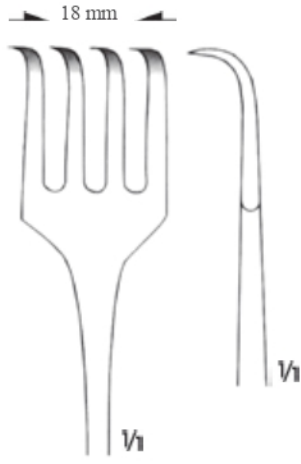
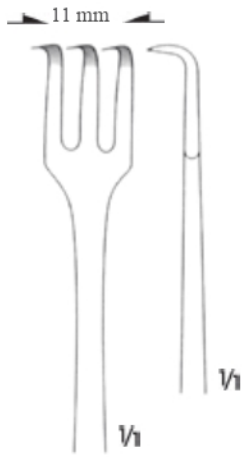

51-148



51-149



51-150



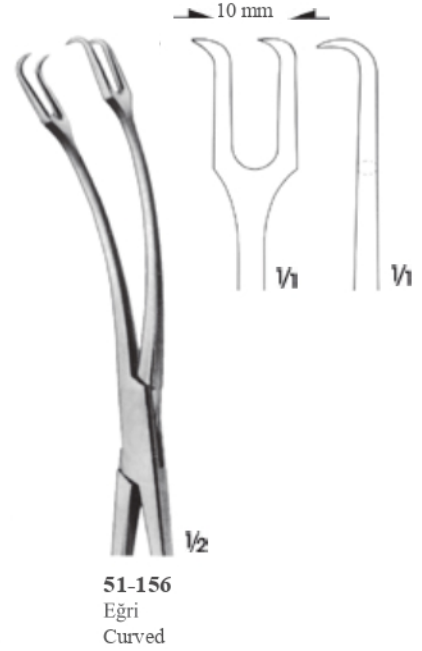
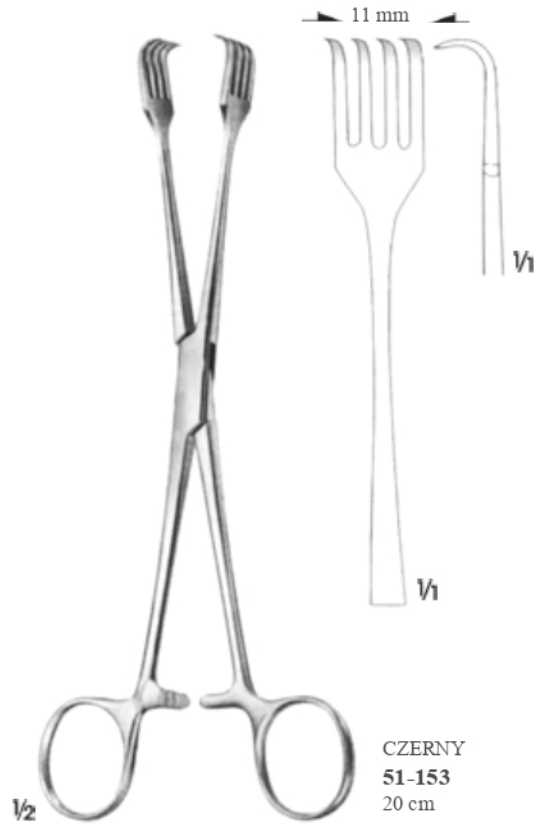
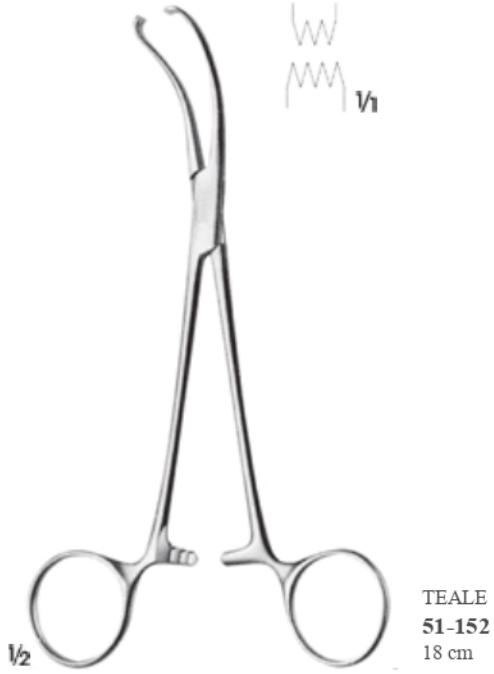

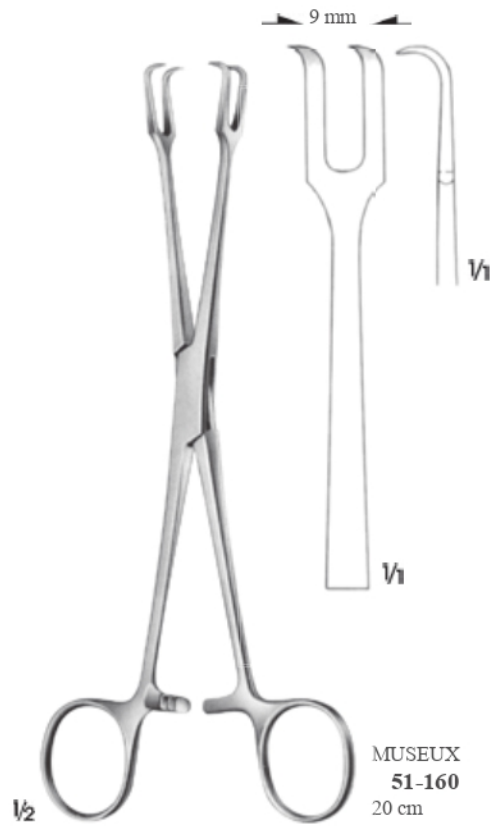
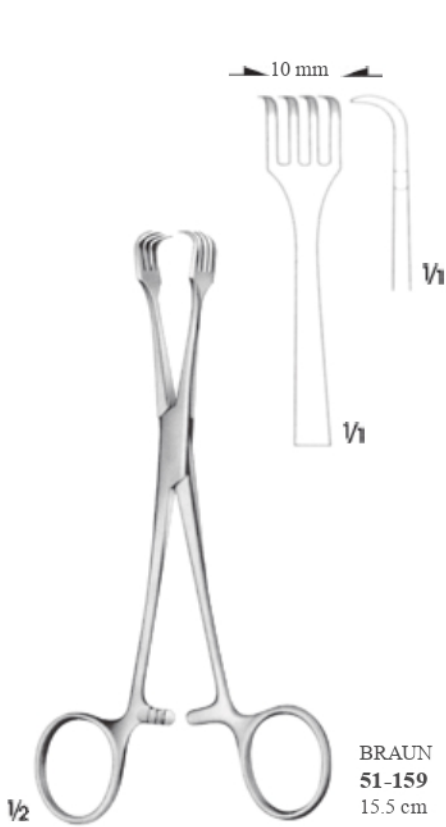
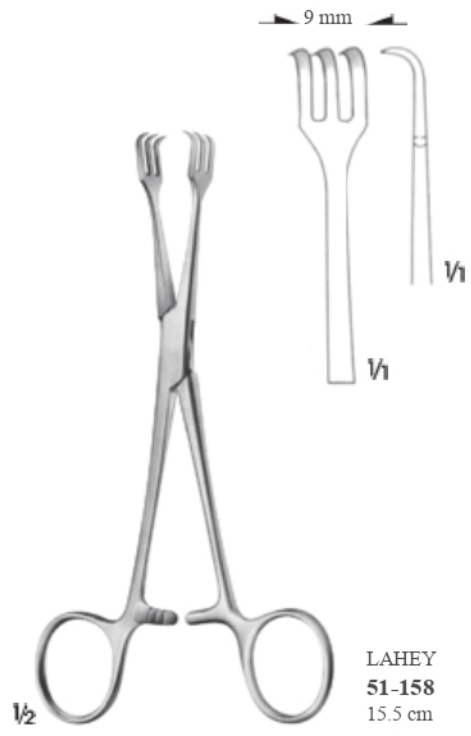
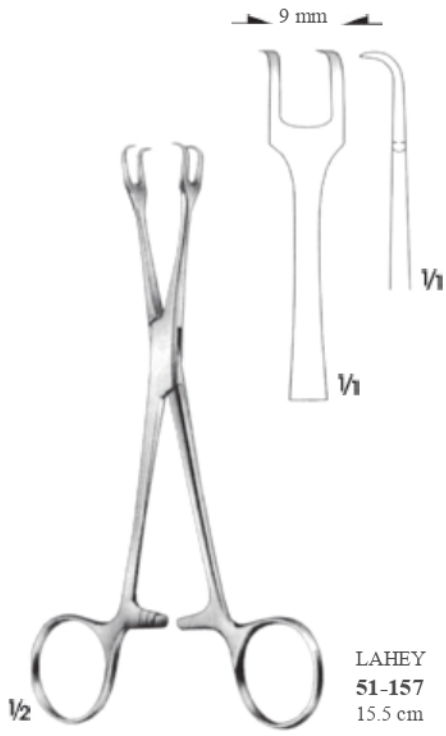



LITTLEWOOD
51-161
18.5 cm



TEALE
51-162
22.5 cm



MUSEUX
Yana eğri
Curved to side
24 cm



KÜSTNER
51-165
25 cm



MUSEUX
51-166
20 cm



JACOBS
51-167
21.5 cm



MUSEUX
24 cm



51-178

51-169

51-170



MUSEUX
26.5 cm

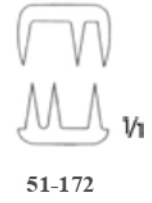

51-171

51-172



DUBLAY
51-173
25 cm

51-174
26.5 cm

ABEL
51-175
28 cm

Uterin Tenekulum Pensleri
Uterine Tenaculum Forceps



SCHRÖDER
51-176
Standart Model
Standart pattern
25 cm

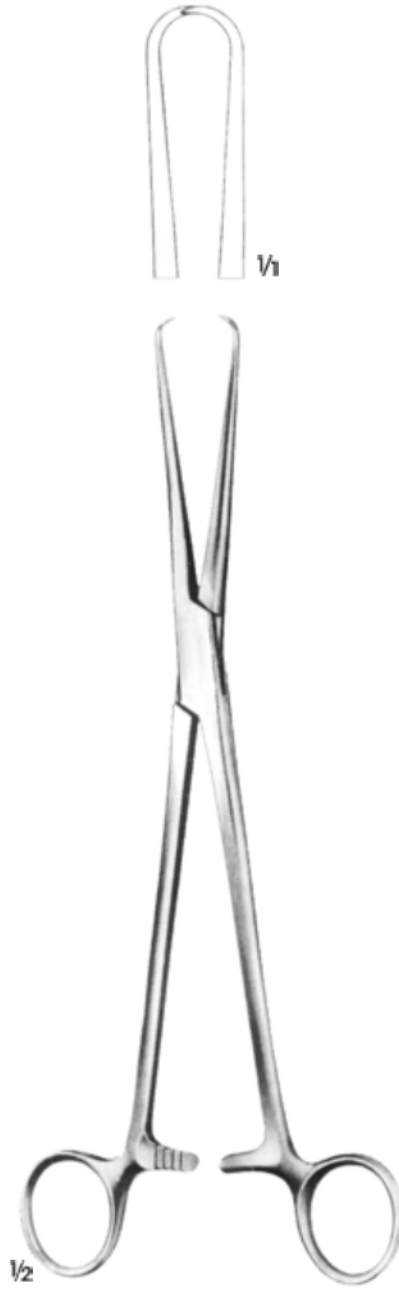

POZZI
51-177
Zorlu operasyon için
Heavy pattern
25.5 cm



SCHRÖDER
51-178
25 cm



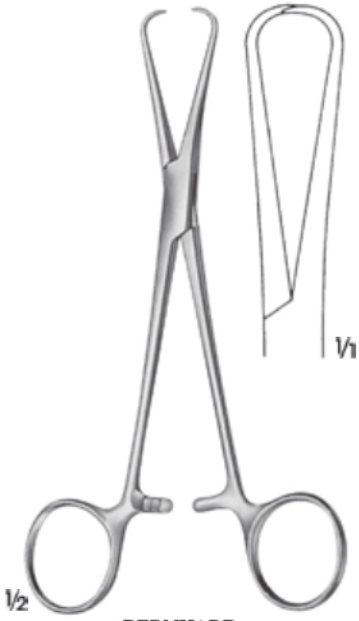

BERNHARD
51-179
16 cm



POZZI
51-180
17.5 cm

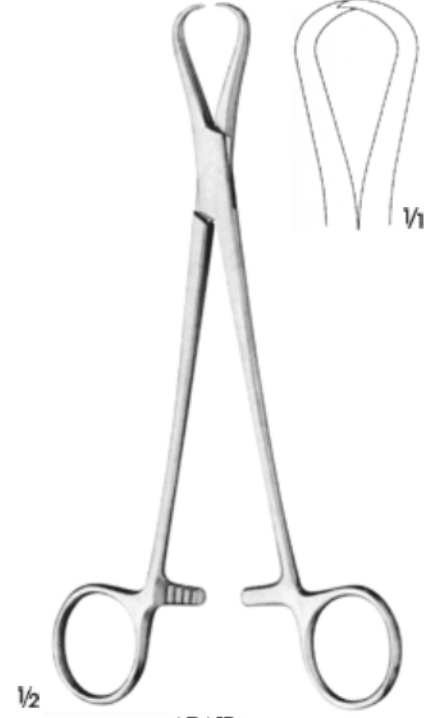

ADAIR
51-181
19 cm



BRAUN
51-182
Narin Model/Slender pattern
25 cm



COLLIN-POZZI
51-183
25 cm



WILSON
51-184
24 cm



51-185 - 51-186
Göbek bağı makaları
Umbilical cord scissors



51-185
13.5 cm



51-186
16 cm



SCHUMACHER
51-187
Göbek bağı makası
Umbilical cord scissor
15.5 cm



51-188
Göbek bağı makası
Umbilical cord scissors
10.5 cm





KIEBACK
51-189 - 51-190
Parametrium makaslar
Parametrium scissors



51-189
24 cm



51-190
35 cm



KEIBACK
Parametrium
makaslar
1 bleydi küre uclu, yana eğri
Parametrium scissors, curved to side,
with 1 probe pointed blade



51-191
26 cm

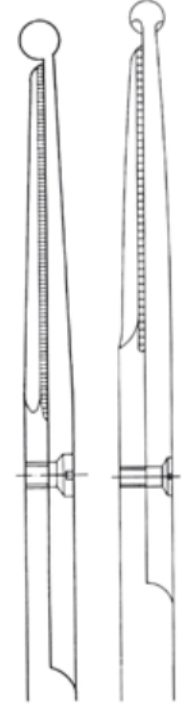

51-192
35 cm



BRAUN-STADLER
Epizyotomi makasları
Episiotomy scissors



51-193
14.5 cm



51-194
20 cm



51-195 Epizyotomi
makas Episiotomy
scissors 24 cm

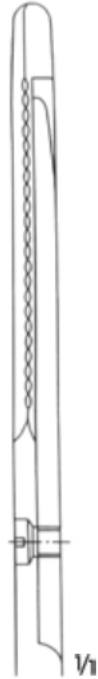

1/2

51-196
Göbek dilatörü
Umbilical dilator
9.5 cm



1/2

COLLIN
51-197
Göbek kordonu klempe
Umbilical cord clamp
8.5 cm





BURKE

Parametrium pensler, kısa ağızlı
Parametrium clamps, short jaw part

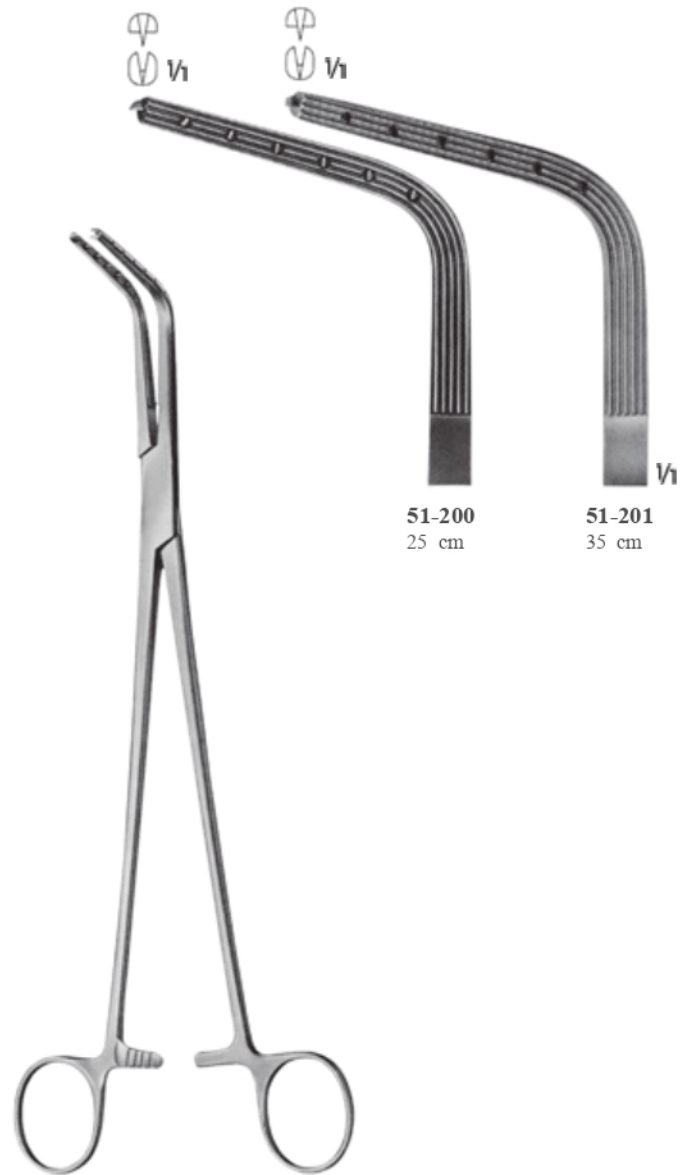

BURKE

Parametrium pensler, uzun ağızlı
Parametrium clamps, long jaw part



Çengel ağız ile daha güvenilir tutuş sağlar.
Ağız geniş açılabilir.
Düzgün ve uygun kesme sağlar.
Deforme olmamış ezilmemiş parça alınmasına imkan verir.
Travma'ya neden olmaması nedeni ile iyileşme çabuk olur.
More reliable grip on the tissue due to 'hooking' effect.
Wide angle of opening.
Smooth, steady cut.
Specimens are not squashed.
Not painful; self-wound, heals well.



51-202



51-203



51-204
2 mm



51-205
2.4 mm

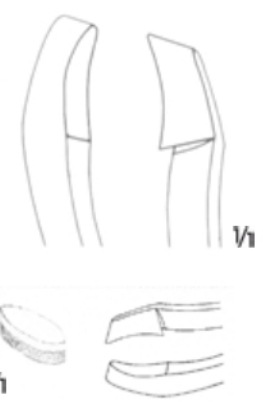

51-206
2.4 mm

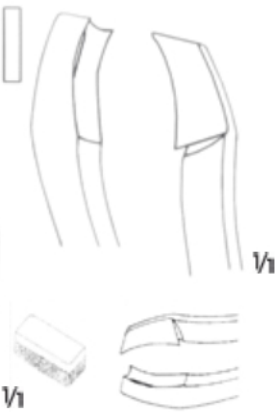

1/2

SCHUMACHER
24 cm



1/2

SEIDL DBP
Bayonet biyopsi pensleri
Bayonet-Shaped biopsy forceps
24 cm



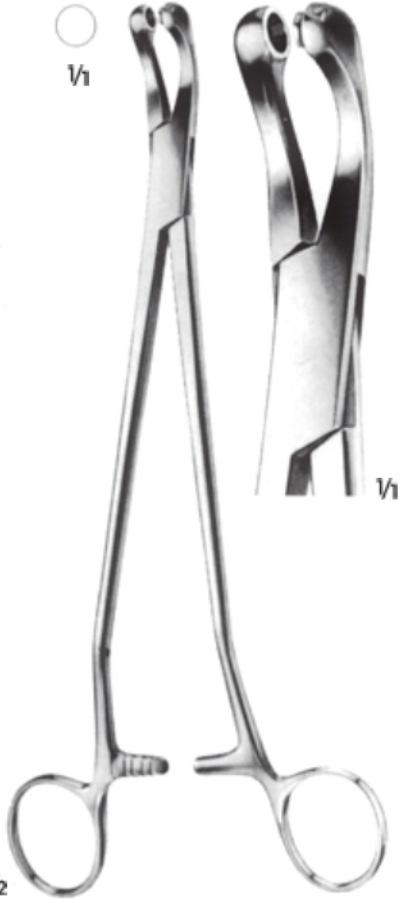

THOMS-GAYLOR
51-207
24 cm



SCHUBERT
51-208
26 cm



FAURE
51-209
21 cm



FAURE
51-210
24 cm

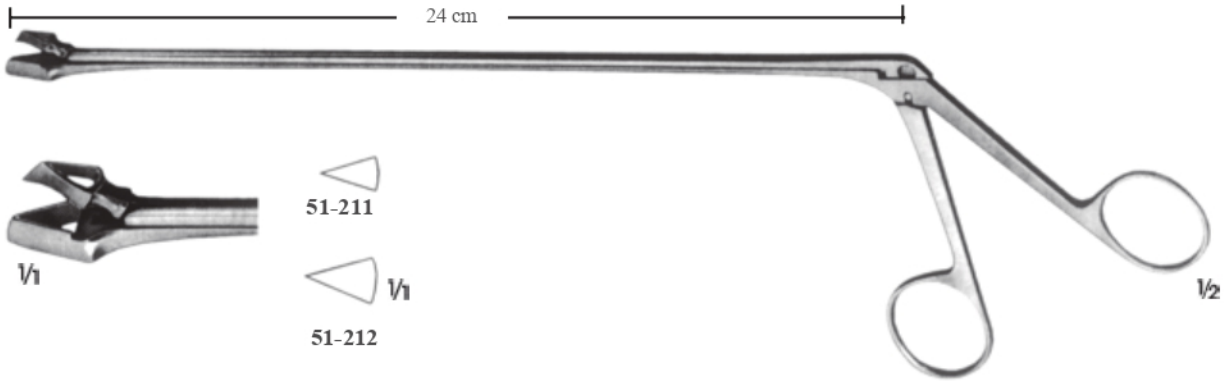

SCHUMACHER
Kolkoskopi için uygun
Suitable for colposcopy
24 cm

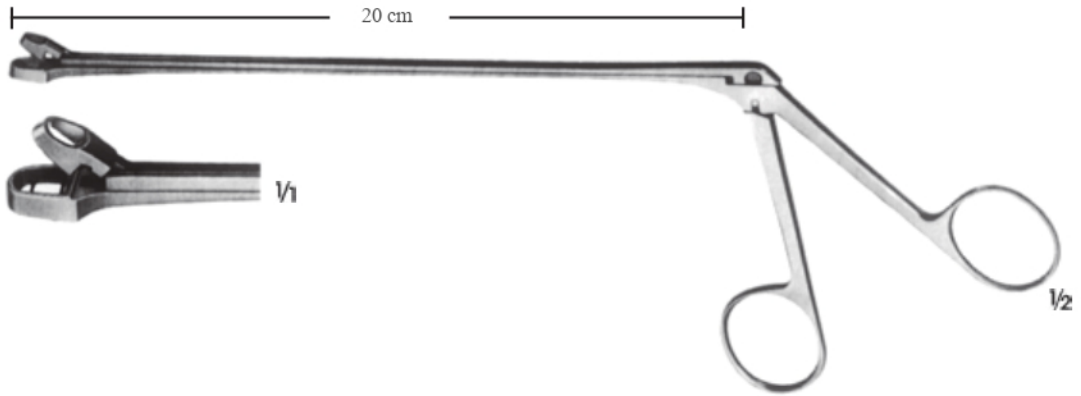

EPPENDORF
51-213
Kolkoskopi için uygun
Suitable for colposcopy
20 cm

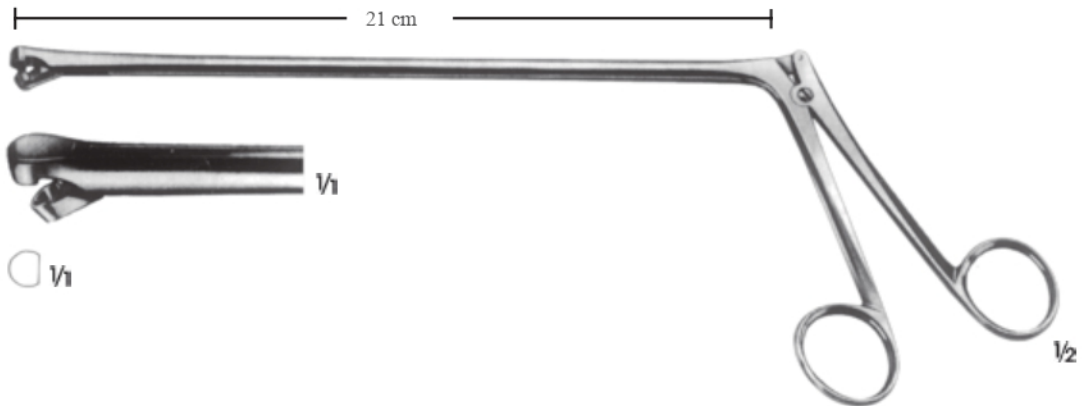

BERGER
51-214
21 cm

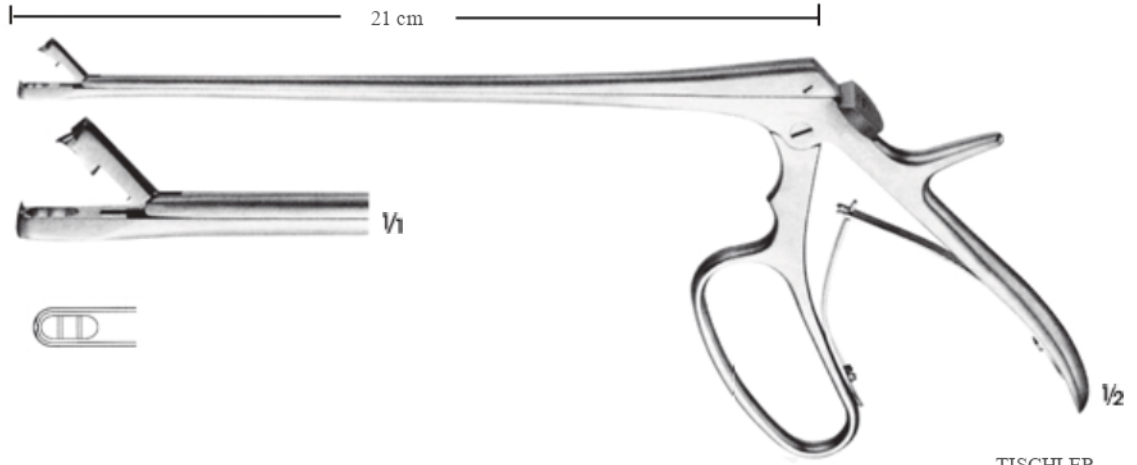

TISCHLER
51-215

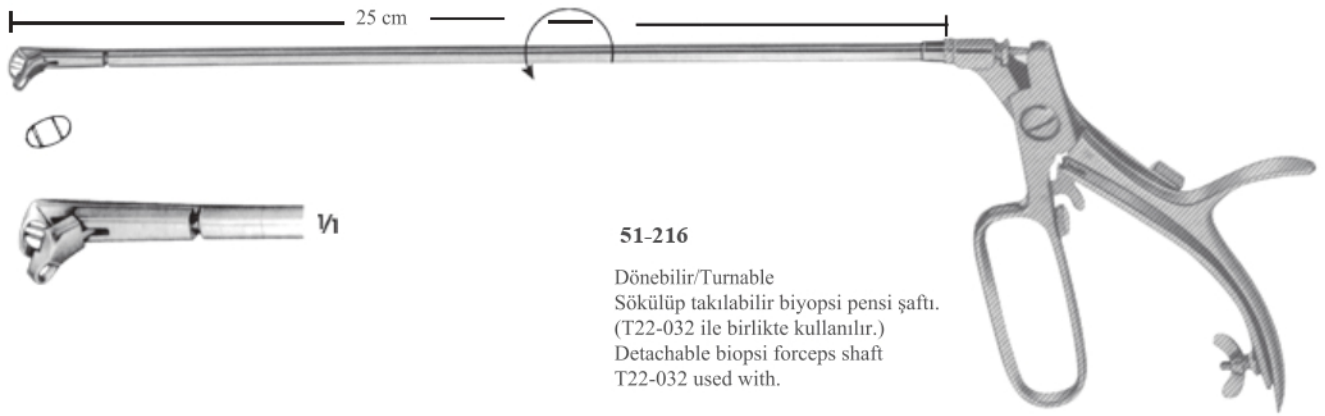

51-216

Dönebilir/Turnable
Sökülüp takılabilir biyopsi pensi shaftı.
(T22-032 ile birlikte kullanılır.)
Detachable biopsy forceps shaft
T22-032 used with.



51-217
Universal sap
Universal handle
14 cm

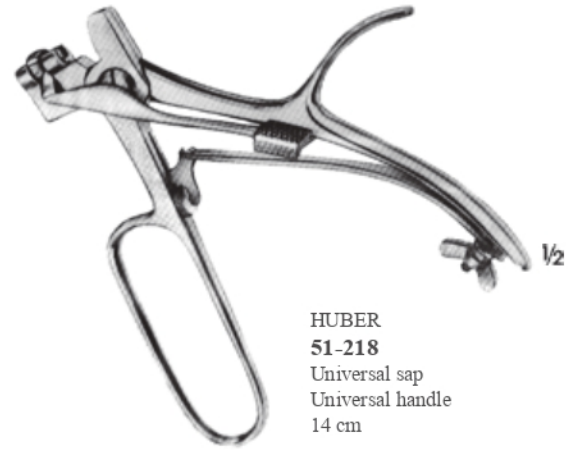

HUBER
51-218
Universal sap
Universal handle
14 cm



BRÜNNINGS
51-219 20 cm
51-220 25 cm
Uzatma kanülü/Extension cannula

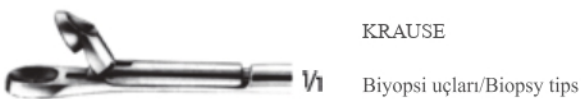

KRAUSE
Biyopsi uçları/Biopsy tips



SCHUMACHER
51-223
Biyopsi ucu/Biopsy tip

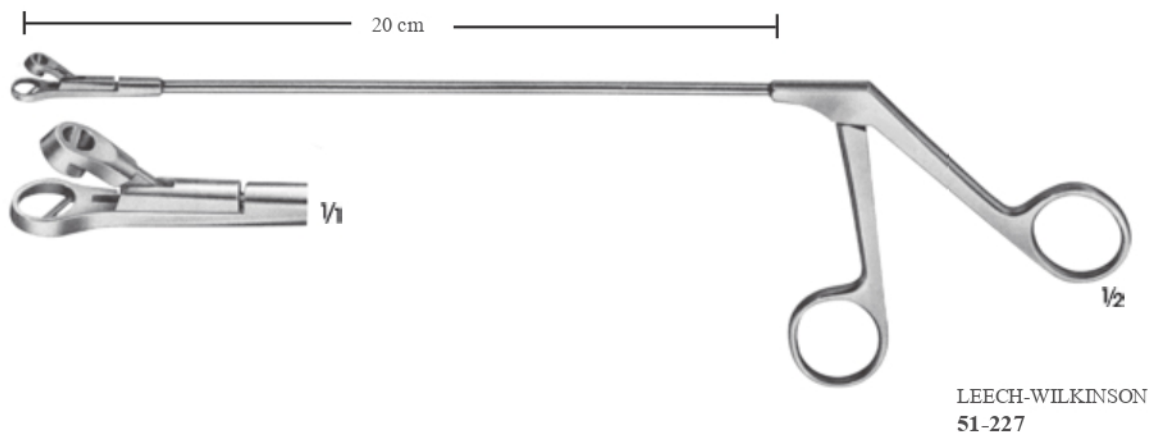
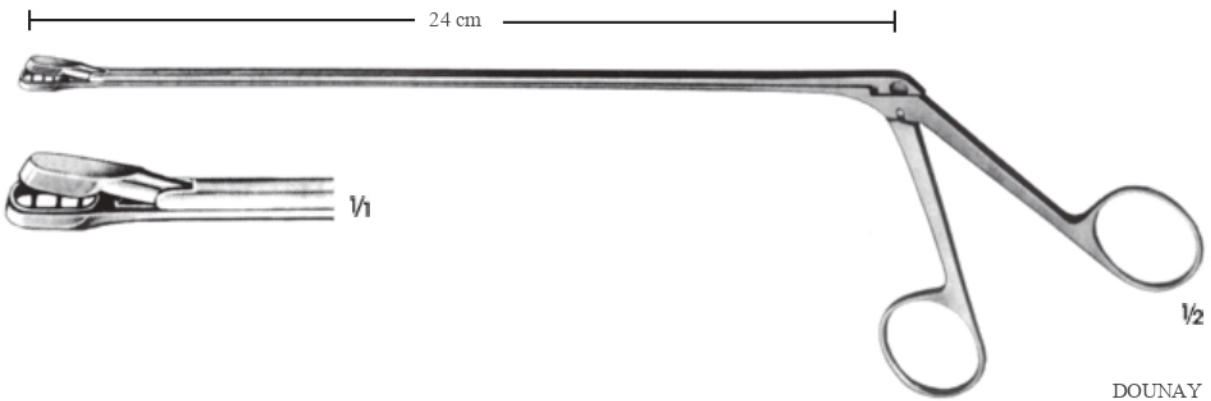
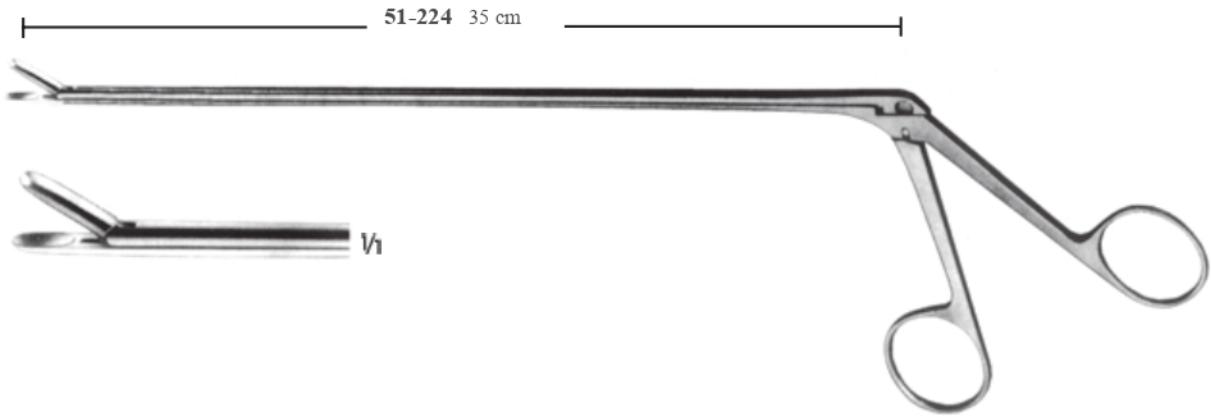



RECAMIER
51-228 - 51-229
 Sivri-Rijid/Sharp-Rigid
51-240 - 51-250
 Sivri-Bükülebilir/Sharp-Malleable
51-251 - 51-258
 Kunt-Rijid/Blunt-Rigid
 30 cm

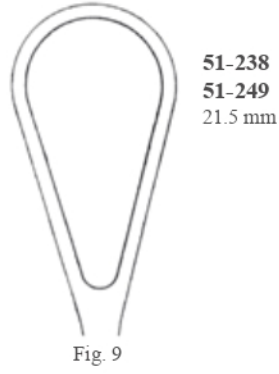

51-238
51-249
 21.5 mm



51-239
51-250
 23.5 mm

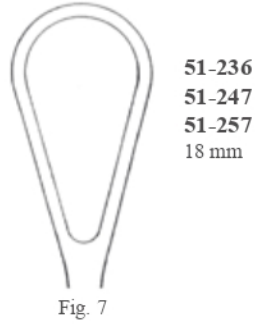

51-236
51-247
51-257
 18 mm

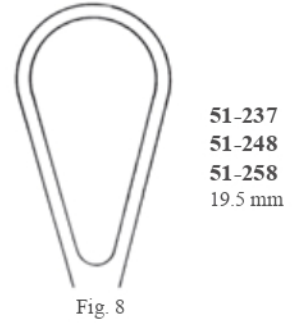

51-237
51-248
51-258
 19.5 mm

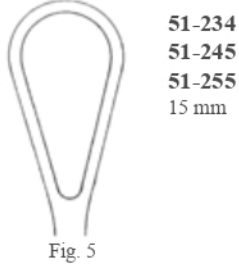

51-234
51-245
51-255
 15 mm

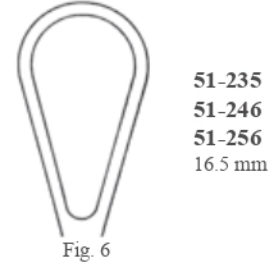

51-235
51-246
51-256
 16.5 mm

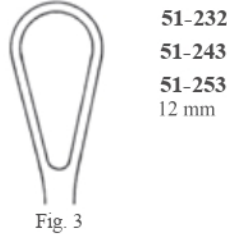

51-232
51-243
51-253
 12 mm

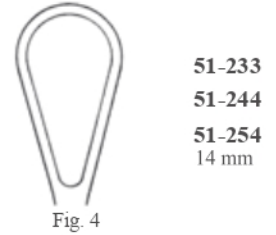

51-233
51-244
51-254
 14 mm

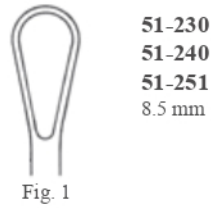

51-230
51-240
51-251
 8.5 mm

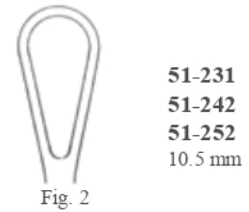

51-231
51-242
51-252
 10.5 mm

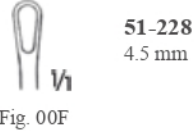

51-228
 4.5 mm

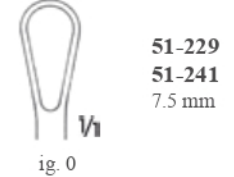

51-229
51-241
 7.5 mm

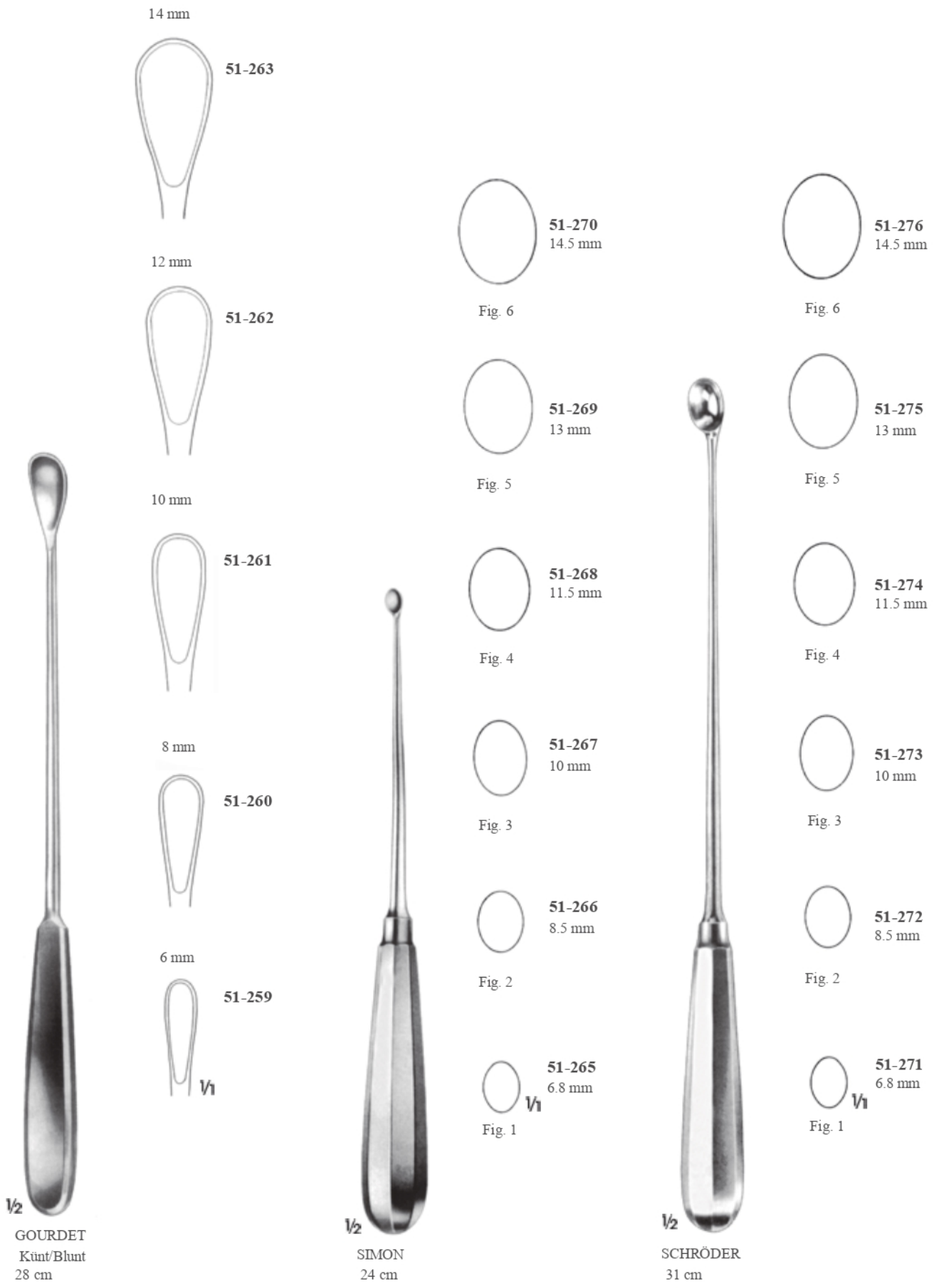

$\frac{1}{2}$
GOURDET
Künt/Blunt
28 cm

$\frac{1}{2}$
SIMON
24 cm

$\frac{1}{2}$
SCHRÖDER
31 cm



51-282
51-288
51-294
15 mm

Fig 6



51-298
28.5 mm

Fig 6



51-281
51-287
51-293
14 mm

Fig 5



51-297
23.5 mm

Fig 4



51-301
26 mm

Fig 5



51-280
51-286
51-292
12 mm

Fig 4



51-296
19.5 mm

Fig 2



51-300
21.5 mm

Fig 3



51-279
51-285
51-291
10.5 mm

Fig 3



51-278
51-284
51-290
8.5 mm

Fig 2



51-277
51-283
51-289
7.5 mm

Fig 1



51-295
16 mm

Fig. 0



51-299
18 mm

Fig. 1

SIMS

51-277 - 51-282

Sivri-Rijid/Sharp-Rigid

51-283 - 51-288

Sivri-Bükülebilir/Sharp-Malleable

51-289 - 51-294

Künt-Rijid/Blunt-Rigid

25.5 cm

BUMM

51-295 - 51-301

Künt-Bükülebilir/Blunt-Malleable

29 cm

1/2

1/2





SPACKMAN
51-311 Ayarlanabilir
plaka ile vulsulum pensi
With adjustable plate for
vulsulum forceps
36 cm



BEHRMAN
51-312
Konik ucu çıkartılabilir
uterin kanülü
Uterine cannula with
detachable cone
30.5 cm



ROTUNDA
51-313
İrrigasyon kanülü
Irrigation cannula
20 cm





Luer-Lock
Luer-Lock

1/2

NOVAK-SCHOECKAERT
51-314
Biyopsi küreti
Biopsy curette
24 cm



Luer-Lock
Luer-Lock

1/2

RANDALL
51-315
Biyopsi küreti
Biopsy curette
24 cm



Ø 3.5 mm

1/2

BERLIN
51-316
Biyopsi küreti
Biopsy curette
27 cm



Ø 4 mm

1/2

MÜNCHEN
51-317
Biyopsi küreti
Biopsy curette
27 cm

Bükülebilir
Malleable



Künt/Blunt

1/2

ASCH
51-318
Kaşık/Scoop
20 cm



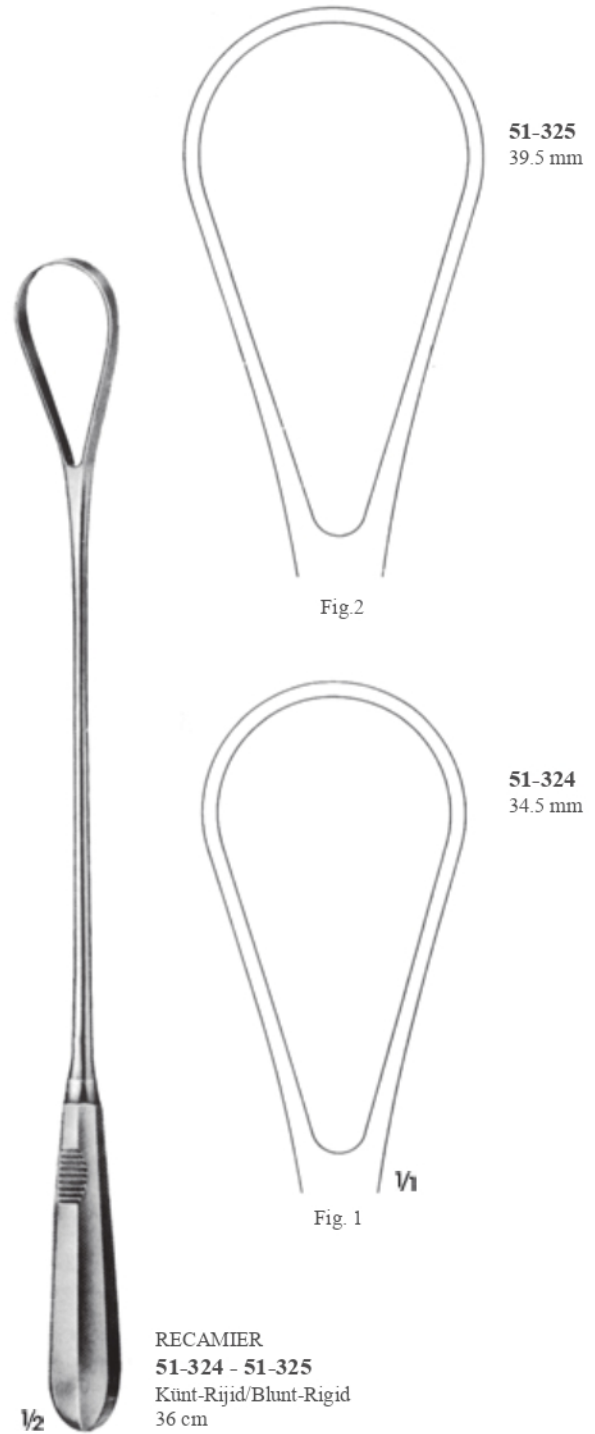
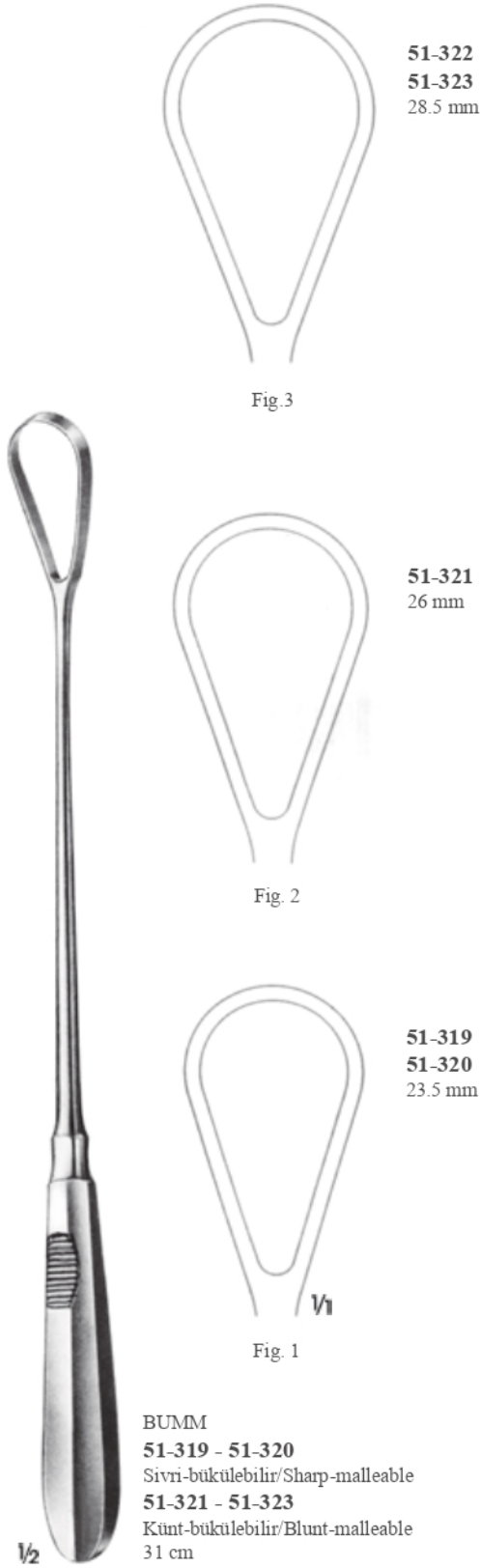



BLAKE
51-326
27.5 cm



HEANEY
51-327
24 cm



COLLIN
51-328
30 cm

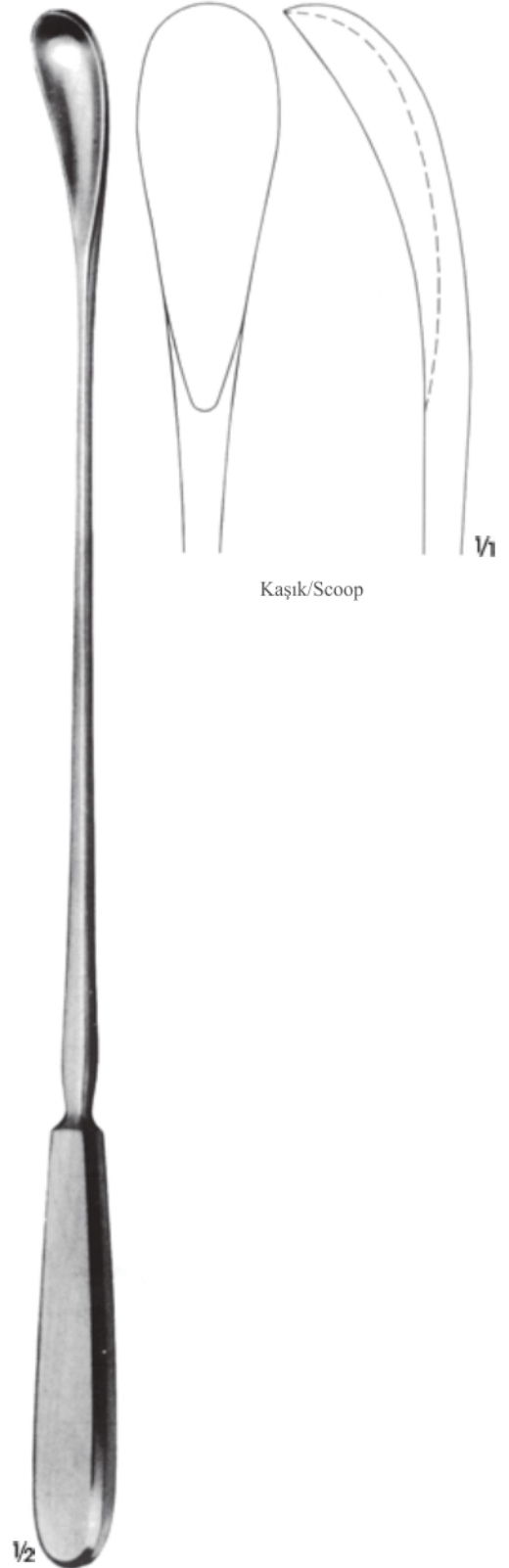

WALLICH
51-329
42 cm

Kaşık/Scoop

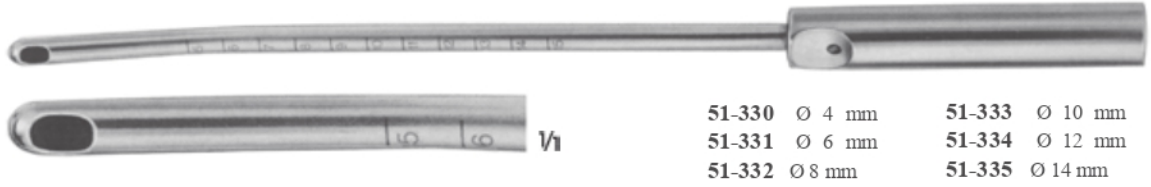

51-330 Ø 4 mm
51-331 Ø 6 mm
51-332 Ø 8 mm
51-333 Ø 10 mm
51-334 Ø 12 mm
51-335 Ø 14 mm

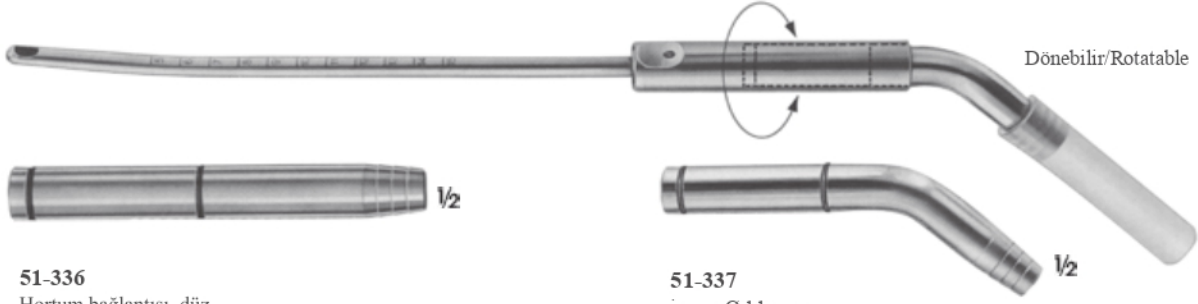

51-336
Hortum bağlantısı, düz
Hose connection, straight
iç çap Ø 11 mm
inside diam Ø 11mm

51-337
iç çap Ø 11 mm
inside diam Ø 11mm

Dönebilir/Rotatable



51-338 40 mm
51-339 50 mm
51-340 60 mm
Çekme kolu ile birlikte
With traction handle
134°C Otoklav edilebilir
134°C Autoclavable



51-341
El vanası ve bağlantı borusu
20 cm uzunluğunda bağlantı borusu
Hand valve with connection hose
20 cm long connection hose



**GREEN-ARMYTAGE
51-342**
Sezeryan hemostatik pens düz
Caesarean hemostatic forceps,
straight
22 cm

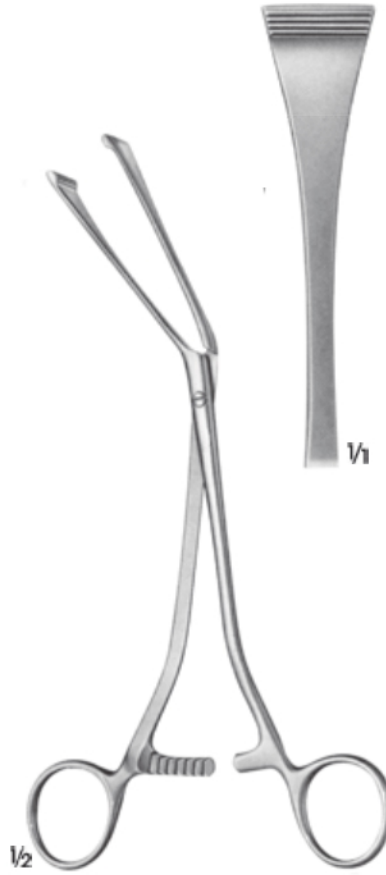

**GREEN-ARMYTAGE
51-343**
Sezeryan hemostatik pens, açılı
Caesarean hemostatic forceps,
angled
19.5 cm

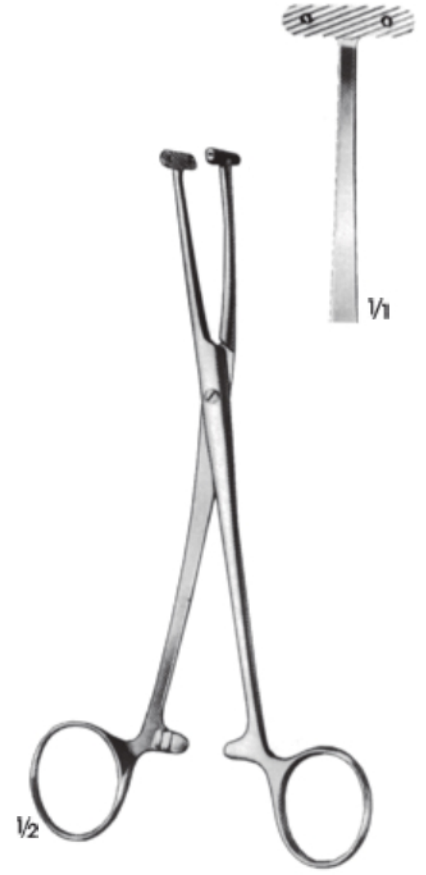

**WILLETT
51-344**
Kafa derisi tutucu pens
Scalp flap forceps
18.5 cm

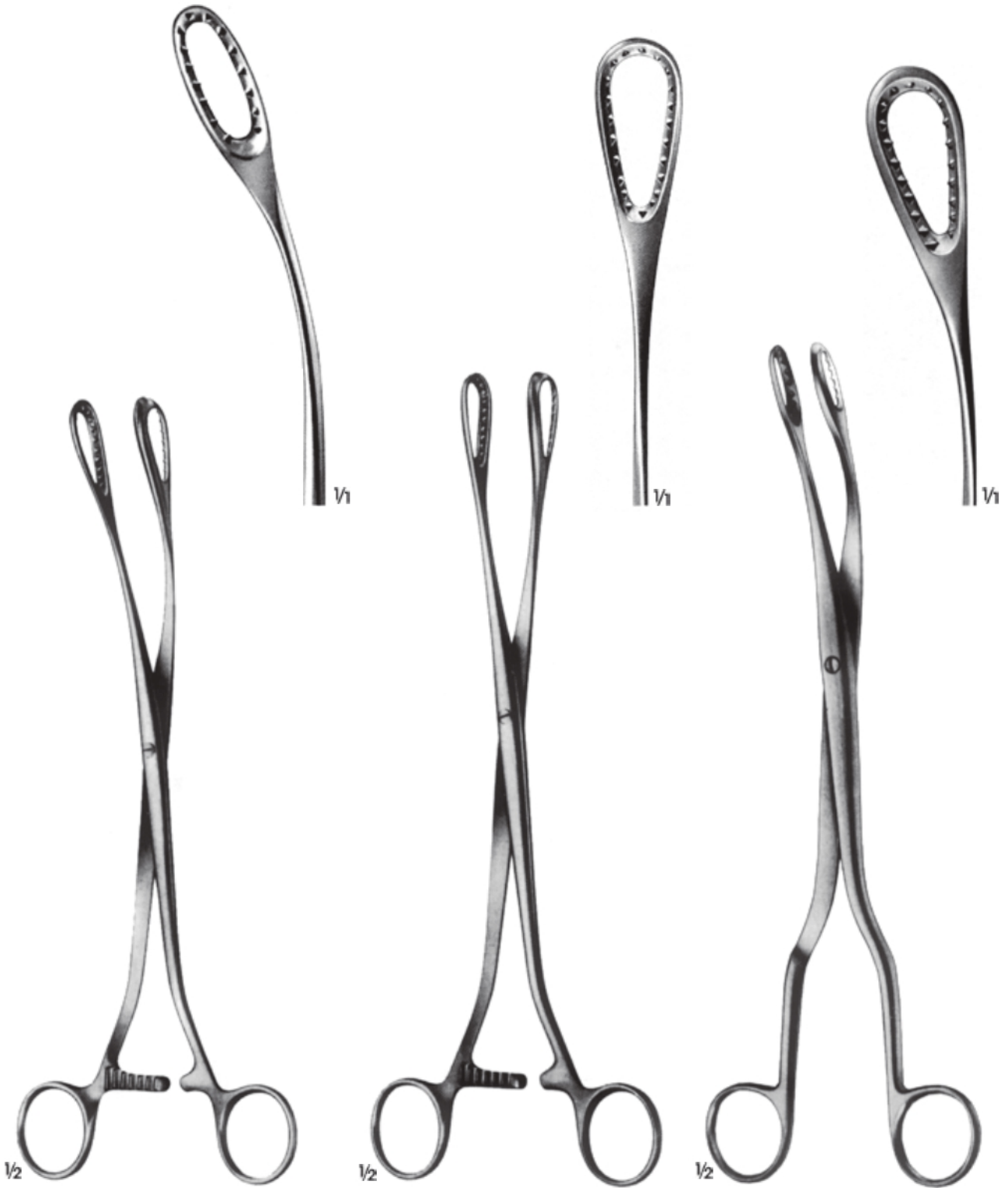

$\frac{1}{2}$
SAENGER
51-345
26.5 cm

$\frac{1}{2}$
SAENGER
51-346
27.5 cm

$\frac{1}{2}$
SAENGER
51-347
28.5 cm



51-348 51-349 $\frac{1}{2}$



51-350 51-351 51-352 $\frac{1}{2}$



51-353 51-354 $\frac{1}{2}$



$\frac{1}{2}$ WINTER
29 cm



$\frac{1}{2}$ WINTER
29 cm



$\frac{1}{2}$ WINTER
Kilitli/With ratchet
29 cm

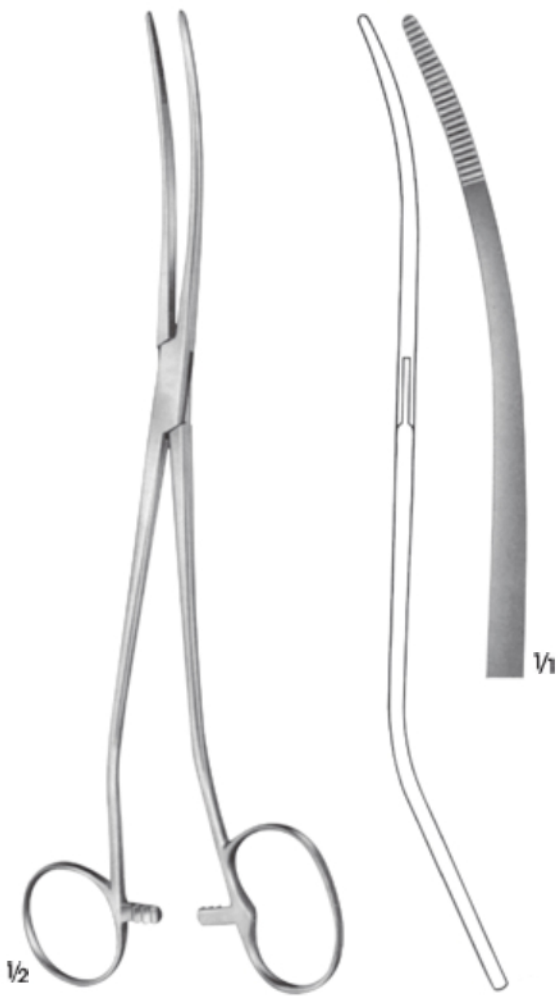

BOZEMANN-DOUGLAS
51-355
26 cm

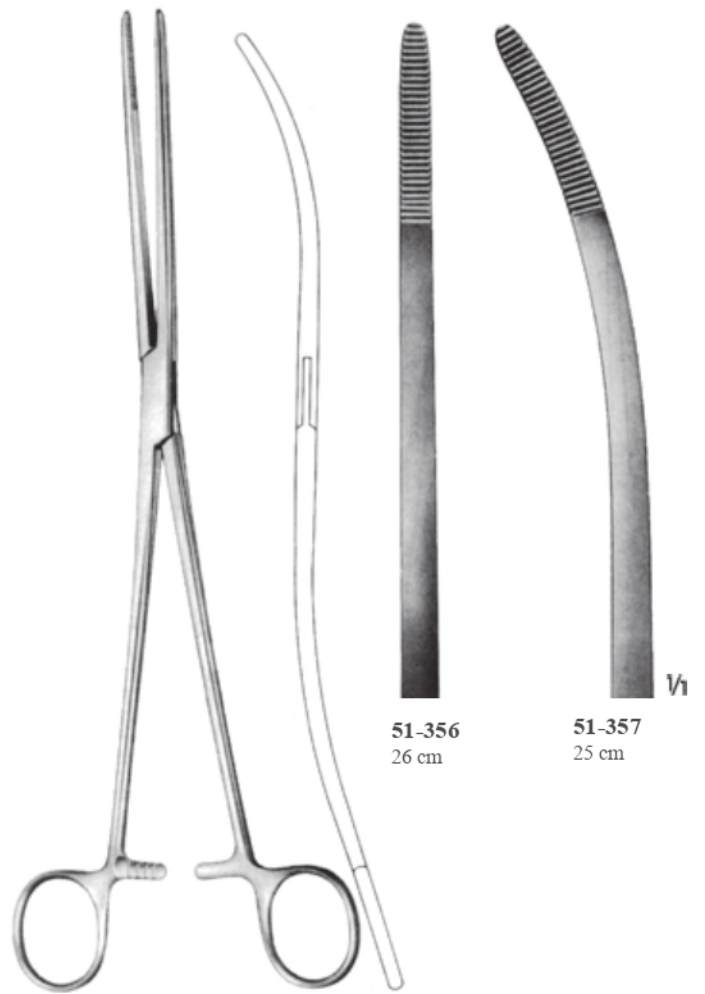

BOZEMANN
51-356 - 51-357





SMELLIE
51-358
27 cm



LEWKOWITZ
51-359 - 51-360
24.5 cm

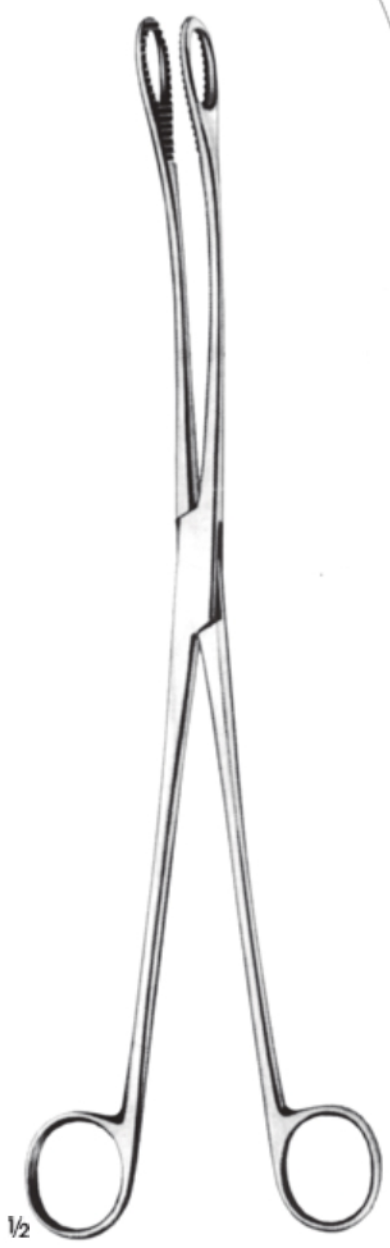

$\frac{1}{2}$
KELLY
51-361
32 cm

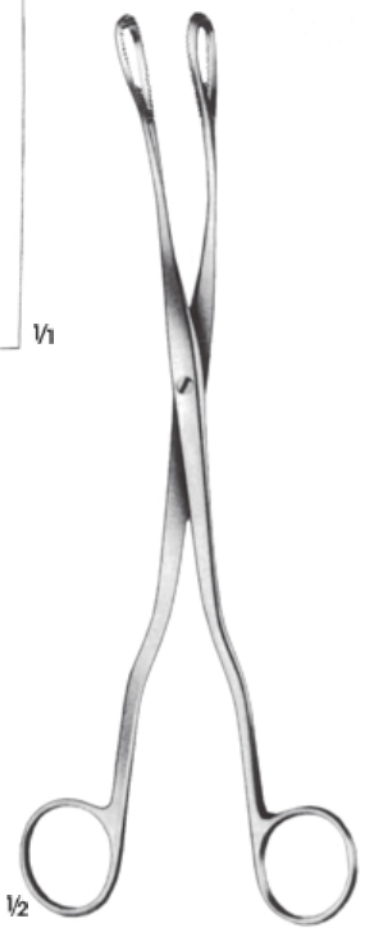

$\frac{1}{2}$
MC CLINTOCK
51-362
24 cm



$\frac{1}{2}$
51-363
28.5 cm



$\frac{1}{1}$
Koruyucu, kapaklı
With protecting cap



51-364	1 mm	51-377	14 mm	51-390	1.5 mm	51-403	14.5 mm
51-365	2 mm	51-378	15 mm	51-391	2.5 mm	51-404	15.5 mm
51-366	3 mm	51-379	16 mm	51-392	3.5 mm	51-405	16.5 mm
51-367	4 mm	51-380	17 mm	51-393	4.5 mm	51-406	17.5 mm
51-368	5 mm	51-381	18 mm	51-394	5.5 mm		
51-369	6 mm	51-382	19 mm	51-395	6.5 mm		
51-370	7 mm	51-383	20 mm	51-396	7.5 mm		
51-371	8 mm	51-384	21 mm	51-397	8.5 mm		
51-372	9 mm	51-385	22 mm	51-398	9.5 mm		
51-373	10 mm	51-386	23 mm	51-399	10.5 mm		
51-374	11 mm	51-387	24 mm	51-400	11.5 mm		
51-375	12 mm	51-388	25 mm	51-401	12.5 mm		
51-376	13 mm	51-389	26 mm	51-402	13.5 mm		

1/2

HEGAR
51-64 - 51-406 Sivri
uclu dilatörler With
very conical point 18.5
cm



1/2

PRATT
51-407 - 51-414
29 cm

51-407	13 - 15 Charr.
51-408	17 - 19 Charr.
51-409	21 - 23 Charr.
51-410	25 - 27 Charr.
51-411	29 - 31 Charr.
51-412	33 - 35 Charr.
51-413	37 - 39 Charr.
51-414	41 - 43 Charr.



1/2

HEGAR
51-415 - 51-423
19.5 cm

51-415	1 + 2 mm
51-416	3 + 4 mm
51-417	5 + 6 mm
51-418	7 + 8 mm
51-419	9 + 10 mm
51-420	11 + 12 mm
51-421	13 + 14 mm
51-422	15 + 16 mm
51-423	17 + 18 mm



UCHIDA
51-424 27 cm
51-425 35 cm
Kaşıklar/Spoons



KEIBACK
51-426 23.5 cm
51-427 35 cm
Yan kavisli üretral tünel pensleri
Ureteral tunnel clamps, curved to side



51-426
23.5 cm



51-427
35 cm





MAYO
51-428 Bükülebilir/
Malleable 33 cm



SIMS
51-429 33 cm
51-430 33 cm
Bükülebilir/Malleable



51-431
30 cm



SIMPSON
51-432
Bükülebilir, gümüş kaplama
Malleable, silver-plated
31 cm





BRAUN
51-433
Uterin bastırıcı
Uterine depressor
27 cm

Ø 3.6 mm



GALABINS
51-434
Ölçülü mil, bükülebilir
Shaft graduated in cm, malleable
29.5 cm

Ø 4 mm



VALLEIX
51-435
Ölçü kaydırıcı, göstergeli
Graduated, with slider
25 cm



MARTIN
51-436
Santimetre ölçülü
Graduated in centimeters



DE LEE
51-437
Pelvimetre santimetre ve inç ölçülü
Pelvimeter centimeters and inches
measured



1/1



1/2

DOYEN
51-438
Myoma burgusu
Myoma screw
19 cm



1/2

DOYEN
51-439
Myoma burgusu
Myoma screw
15 cm



GELPI
51-440
13.5 cm



GELPI
51-441
17.5 cm



RICHTER
51-442
17 cm



JOLL (FRIEDMANN)
51-443
15.5 cm





BONNEY
51-444
24 cm



COLLIN
51-445
28.5 cm



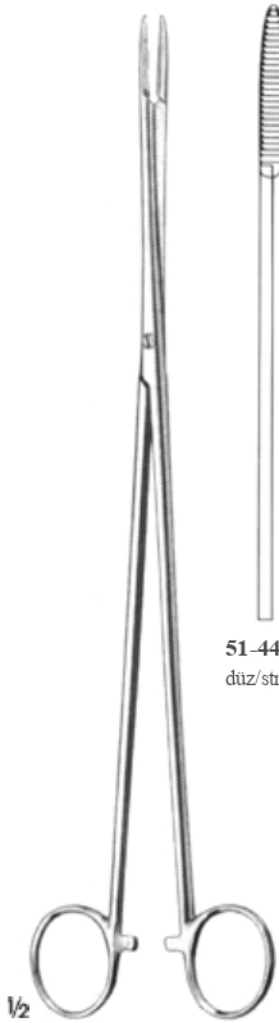

PELKMANN
26 cm



51-446
düz/straight



51-447
eğri/curved

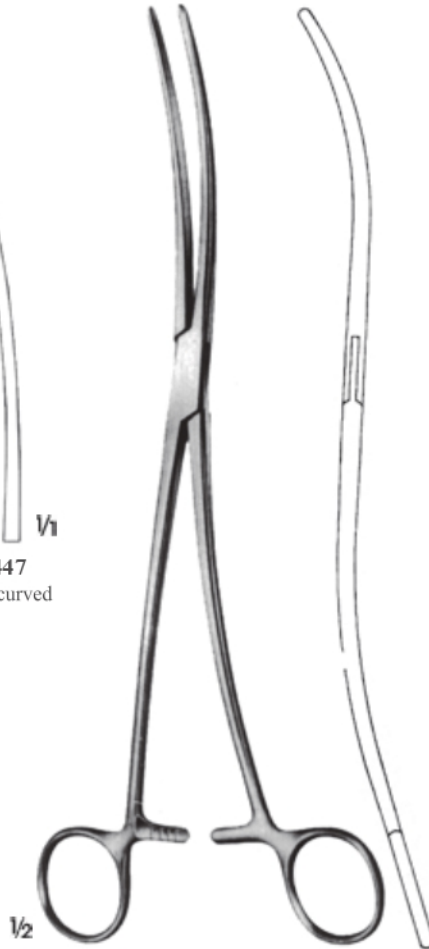

BOZEMANN
51-448
25 cm

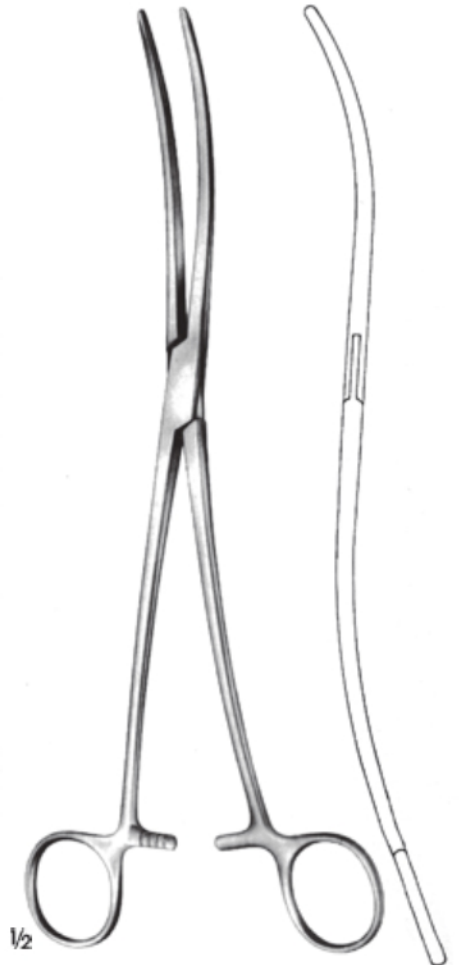

BOZEMANN
51-449
Ağız oluklu pens
Jaws with longitudinal
groove
25.5 cm



KOGAN
51-450
Kilitsiz/Without ratchet
24 cm

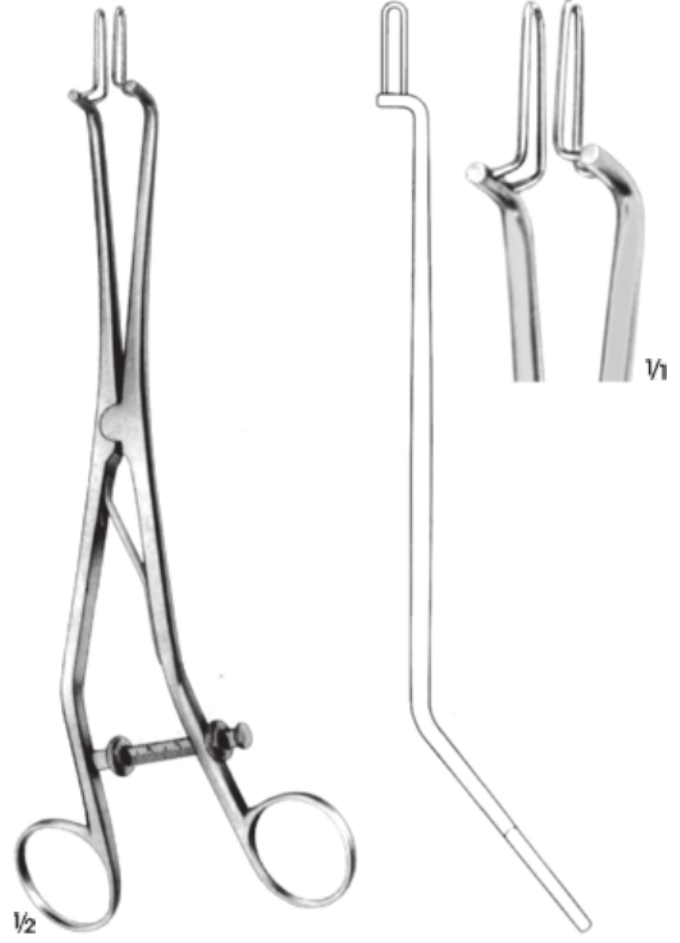

KOGAN
51-451
Ölçülü sabitleyici ayar vidası
With scale-ratchet and fixing screw
24 cm



BREISKY
51-452 100 x 20 mm
51-453 100 x 25 mm
51-454 100 x 30 mm
51-455 100 x 35 mm
51-456 100 x 40 mm
Viyana Model
Vienna patterns
30 cm



BREISKY
51-457 130 x 20 mm
51-458 130 x 25 mm
51-459 130 x 30 mm
51-460 130 x 35 mm
51-461 130 x 40 mm
Viyana Model
Vienna patterns
32 cm



BREISKY
51-462 160 x 40 mm
51-463 180 x 40 mm
Viyana Model
Vienna patterns
35 cm



LANDAU
51-464 100 x 28 mm
51-465 110 x 38 mm
29 cm

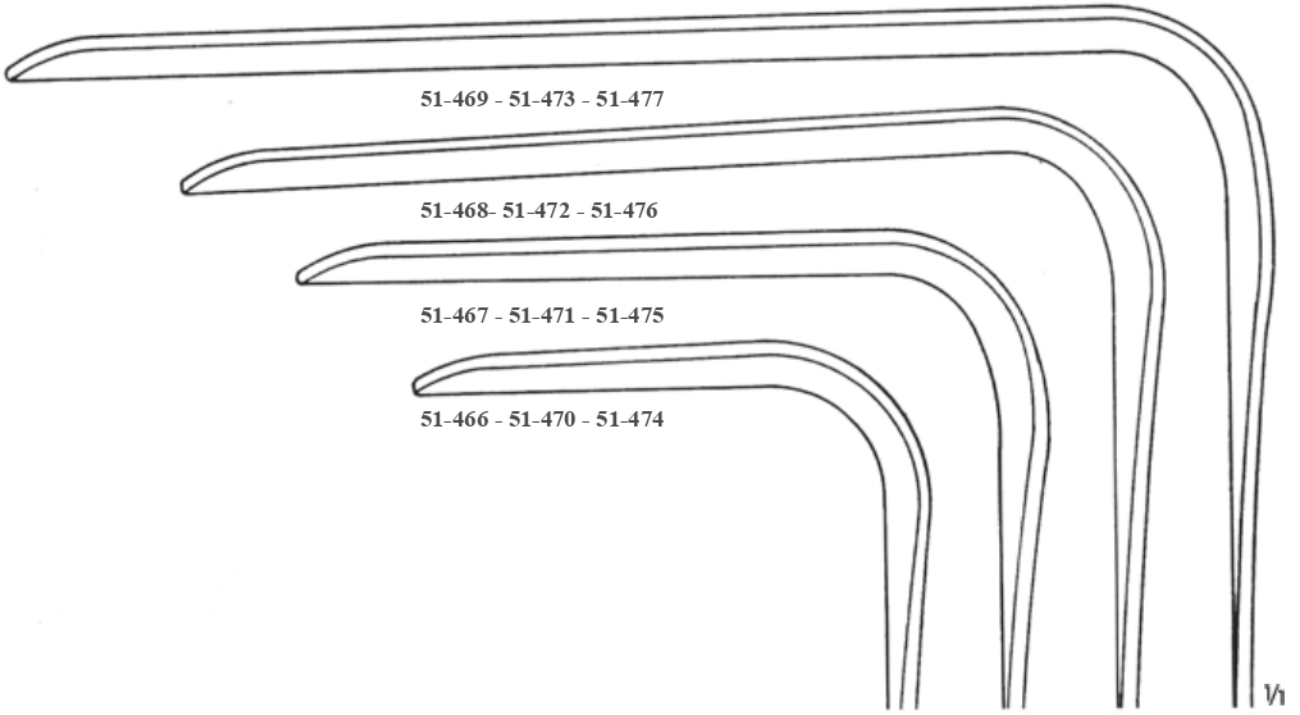

DOYEN
24 cm

Ağız uzunlukları
Length of blades

Ağız genişlikleri
Width of blades

	35 mm	45 mm	60 mm
60 mm	51-466	51-470	51-474
90 mm	51-467	51-471	51-475
120 mm	51-468	51-472	51-476
160 mm	51-469	51-473	51-477

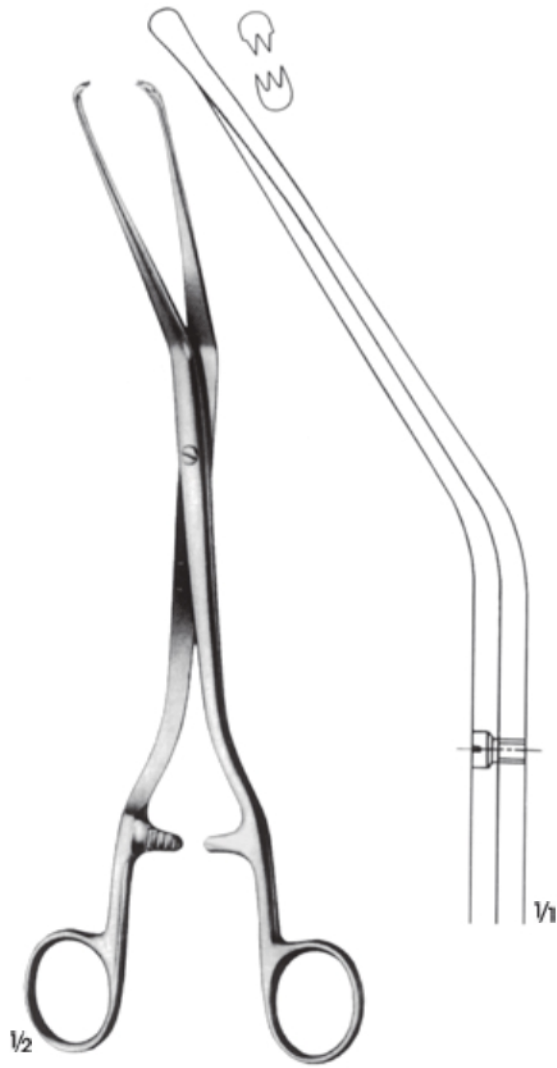

HERFF
51-478
Zar delici pens
Membrane puncturing forceps
25.5 cm



BEACHAM
51-479
Amniyotom/Amniotome
24 cm



51-480
Poş Açıcı/Pouch opener
44 cm





1/2
TÜBINGER
51-481
95 x 20 mm
26.5 cm

1/2
51-482
105 x 27 mm
25 cm

1/2
SIMON
51-483
115 x 22 mm
27.5 cm

1/2
SIMON
51-484
115 x 26 mm
27.5 cm



WEISSBARTH
51-485 80 x 28 mm
51-486 85 x 42 mm
21 cm

51-487
Sökülebilir süzgeçli
Removable strainer only

1/2



AUVARD
51-488
65 x 38-28 mm
1.530 gr.
Sökülebilir ağırlıklı
Wiht detachable weight
23 cm

1/2



AUVARD
51-489 75 x 42-40 mm
51-490 105 x 43-40 mm
1.470 gr. sökülebilir ağırlıklı
With detachable weight
23 cm

1/2



AUVARD
51-491
65 x 38-28 mm
1.530 gr.
Sabit ağırlık
Fixed weight
23 cm

1/2



DOYEN
T22-cm
23.5 c

1/2

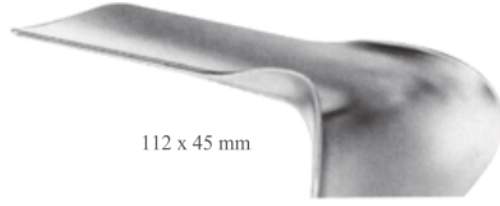

112 x 45 mm

51-494

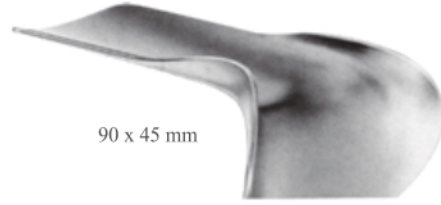

90 x 45 mm

51-493



60 x 45 mm

51-492

1/2



60 x 30 mm

DOYEN
51-495
Yanal spekulum
Lateral speculum
23 cm

1/2



80 x 30 mm

DOYEN
51-496
Yanal spekulum
Lateral speculum
25 cm

1/2



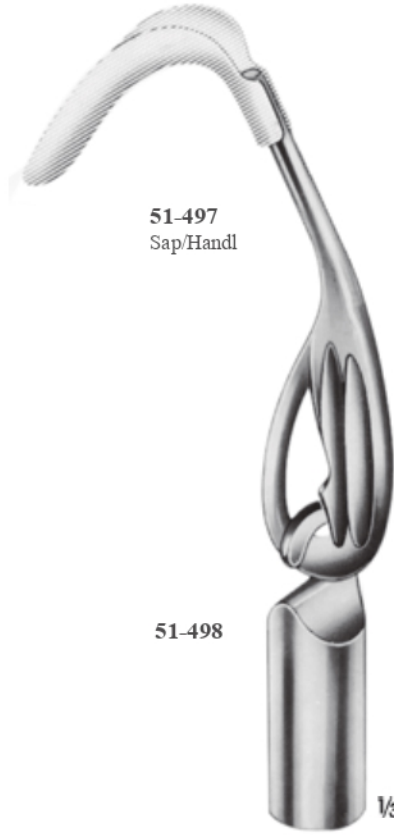

51-497
Sap/Handl

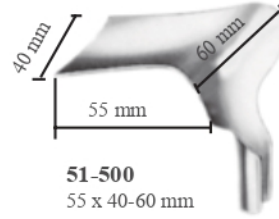

51-500
55 x 40-60 mm



51-501
80 x 30 mm



51-502
85 x 35 mm



51-503
85 x 40 mm

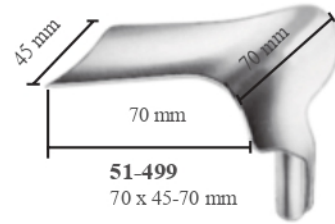

51-499
70 x 45-70 mm

51-498

SCHERBACK

1/3



51-504
23 cm



51-505
22 cm

BOZEMANN



51-506
65 x 30 mm



51-510
80 x 30 mm



51-507
75 x 35 mm



51-511
85 x 33 mm



51-508
85 x 35 mm

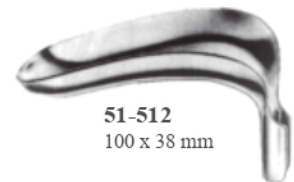

51-512
100 x 38 mm

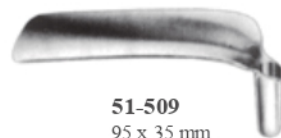

51-509
95 x 35 mm



51-513
110 x 42 mm



$\frac{1}{3}$
WRIGLEY
51-514
Sezeryan ameliyatı için
For caesarean section
25 cm



$\frac{1}{3}$
SELHEIM
51-515
Obstetrik levye
Obstetric lever
30 cm



$\frac{1}{3}$
KIELLAND
51-516
42 cm



$\frac{1}{3}$
PIPER
51-517
44.5 cm



1/3

**SIMPSON
51-518**
Sezeryan ameliyatı için
For caesarean section
23.5 cm



1/3

**SIMPSON-BRAUN
51-519**
30.5 cm



1/3

**SIMPSON-BRAUN
51-520**
35 cm



1/3

**NAGELE
51-521**
35.5 cm



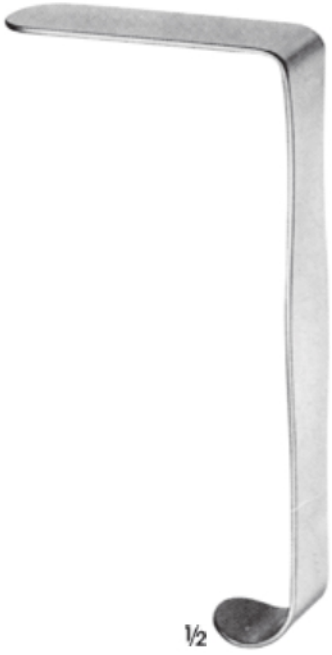

1/2
HEANEY
51-522
89 x 29 mm
17 cm



1/2
EASTMAN
51-523
89 x 38 mm
17.5 cm



1/2
BRAUN
51-524
60 x 10 mm
18 cm



1/2
BRAUN
51-525
56 x 13 mm
18 cm



1/2
LANDON
51-526
89 x 25 mm
19.5 cm



1/2
MATHIEU
51-527
Üst bleyd/Upper blade
95 x 17 - 26 mm
(İç bleyd/Inner blade K 843.01)
21 cm



1/2
MATHIEU
51-528
İç bleyd/Inner blade
95 x 17 - 30 mm
21 cm

KRISTELLER
Alt bleyd/Lower blade



51-529
70 x 15 mm
17.5 cm



51-530
70 x 27 mm
18 cm



51-531
75 x 30 mm
18 cm



51-532
90 x 36 mm
18.5 cm



KRISTELLER
Üst bleyd/Upper
blades



51-533
75 x 10 mm
17.5 cm



51-534
75 x 23 mm
18 cm



51-535
80 x 25 mm
18 cm



51-536
100 x 32 mm
18.5 cm





KRISTELLER

- 51-537** 70 x 27 mm
- 51-538** 75 x 30 mm
- 51-539** 90 x 36 mm
- 51-540** 17.5 cm

1/2



KRISTELLER

- 51-541** 110 x 18 mm
- 51-542** 110 x 20 mm
- 51-543** 110 x 27 mm
- 51-544** 110 x 30 mm
- 51-545** 110 x 36 mm
- 22 cm

1/2



SEIDL

- 51-546** 80 x 8 mm
- 51-547** 80 x 10 mm
- 51-548** 90 x 14 mm
- Çocuklar ve bebekler için
For children and infants
- 17 cm

1/2



KRISTELLER

- 51-549** 70 x 15 mm
- Çocuklar için
For children
- 17 cm

1/2

KRISTELLER
Üst bleyd/Upper
blades 20.5 cm

1/2



51-550
80 x 28 mm



51-551
85 x 35 mm



51-552
85 x 40 mm



1/2

51-553
76 x 38 mm



51-554
89 x 38 mm



51-555
110 x 38 mm



1/2

JACKSON
Alt bleyd/Lower
blades

1/2





KRISTELLER
 Üst bleyd/Upper
 blades



KRISTELLER
 Alt bleyd/Lower
 blades

51-556
 115 x 14 mm
 21.5 cm



51-557
 115 x 23 mm
 21.5 cm

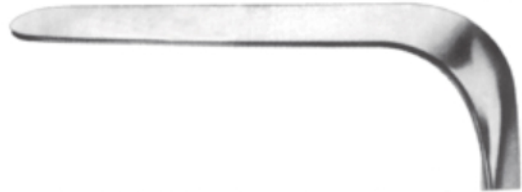

51-558
 115 x 16 mm
 22 cm



51-559
 115 x 26 mm
 22 cm



51-560
 120 x 30 mm
 22.5 cm



1/2

51-561
 110 x 18 mm
 21.5 cm



51-562
 110 x 27 mm
 21.5 cm

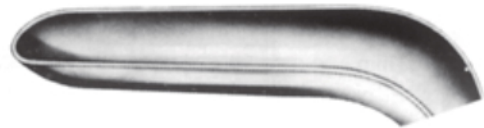

51-563
 110 x 20 mm
 22 cm



51-564
 110 x 30 mm
 22 cm



51-565
 110 x 36 mm
 22.5 cm

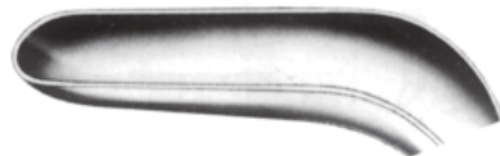

1/2

51-566
110 x 20 mm



51-567
110 x 30 mm



51-568
110 x 36 mm



51-569
115 x 18 mm



51-570
115 x 26 mm



51-571
115 x 32 mm



KRISTELLER
Viyana model set Vienna
patterns sets 21.5 cm



KRISTELLER
Üst bleyd/Upper blade
22 cm





SIMS
51-574 70 x 26 / 75 x 30 mm
 12.5 cm
51-575 75 x 30 / 80 x 35 mm
 15 cm
51-576 80 x 36 / 90 x 40 mm
 17.5 cm

1/2



KALLMORGEN
51-577 Set/Set
 75 x 39 mm
 17 cm

1/2



KALLMORGEN
51-578 Set/Set
 95 x 39 mm
 20 cm

1/2

